

RD2.0E~RD200E

ZENER DIODES

Features

- DHD (Double Heatsink Diode) Construction
- Vz: Applied E24 standard (RD130E to RD200E: 10 volts step).
- DO-35 Glass sealed package.

Applications

Circuits for Constant Voltage, Constant Current,
Waveform clipper, Surge absorber, etc.

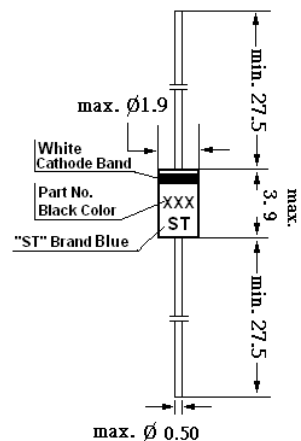

Glass case JEDEC DO-35

Dimensions in mm

Absolute Maximum Ratings ($T_a = 25\text{ }^{\circ}\text{C}$)

Parameter	Symbol	Value	Unit
Power Dissipation	P_{tot}	500	mW
Forward Current	I_F	200	mA
Reverse Surge Power at $t = 10\mu\text{s}$	P_{RSM}	100	W
Junction Temperature	T_j	175	$^{\circ}\text{C}$
Storage Temperature Range	T_s	-65 to +175	$^{\circ}\text{C}$

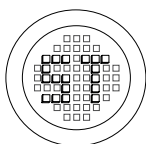

®

РАДИОТЕХ-ТРЕЙД

Тел.: (495) 795-0805
Факс: (495) 234-1603
Эл. почта: info@rct.ru
Веб: www.rct.ru

RD2.0E~RD200E

Characteristics at T_a = 25 °C

Type	Zener Voltage		Dynamic Impedance		Knee Dynamic Impedance		Reverse Current		
	V _Z (V) ¹⁾		Z _Z (Ω) ²⁾		Z _{ZK} (Ω) ²⁾		I _R (μA)		
	Min.	Max.	I _Z (mA)	Max.	I _Z (mA)	Max.	I _Z (mA)	Max.	V _R (V)
RD2.0EB	1.88	2.20	20	140	20	2000	1	120	0.5
RD2.0EB1	1.88	2.10							
RD2.0EB2	2.02	2.20							
RD2.2EB	2.12	2.41	20	120	20	2000	1	120	0.7
RD2.2EB1	2.12	2.30							
RD2.2EB2	2.22	2.41							
RD2.4EB	2.33	2.63	20	100	20	2000	1	120	1
RD2.4EB1	2.33	2.52							
RD2.4EB2	2.43	2.63							
RD2.7EB	2.54	2.91	20	100	20	1000	1	100	1
RD2.7EB1	2.54	2.75							
RD2.7EB2	2.69	2.91							
RD3.0EB	2.85	3.22	20	80	20	1000	1	50	1
RD3.0EB1	2.85	3.07							
RD3.0EB2	3.01	3.22							
RD3.3EB	3.16	3.53	20	70	20	1000	1	20	1
RD3.3EB1	3.16	3.38							
RD3.3EB2	3.32	3.53							
RD3.6EB	3.47	3.83	20	60	20	1000	1	10	1
RD3.6EB1	3.47	3.68							
RD3.6EB2	3.62	3.83							
RD3.9EB	3.77	4.14	20	50	20	1000	1	5	1
RD3.9EB1	3.77	3.98							
RD3.9EB2	3.92	4.14							
RD4.3EB	4.05	4.53	20	40	20	1000	1	5	1
RD4.3EB1	4.05	4.26							
RD4.3EB2	4.20	4.40							
RD4.3EB3	4.34	4.53	20	25	20	900	1	5	1
RD4.7EB	4.47	4.91							
RD4.7EB1	4.47	4.65							
RD4.7EB2	4.59	4.77	20	20	20	800	1	5	1.5
RD4.7EB3	4.71	4.91							
RD5.1EB	4.85	5.35							
RD5.1EB1	4.85	5.03	20	13	20	500	1	5	2.5
RD5.1EB2	4.97	5.18							
RD5.1EB3	5.12	5.35							
RD5.6EB	5.29	5.88	20	10	20	300	1	5	3
RD5.6EB1	5.29	5.52							
RD5.6EB2	5.46	5.70							
RD5.6EB3	5.64	5.88	20	8	20	150	0.5	2	3.5
RD6.2EB	5.81	6.40							
RD6.2EB1	5.81	6.06							
RD6.2EB2	5.99	6.24	20	8	20	120	0.5	0.5	4
RD6.2EB3	6.16	6.40							
RD6.8EB	6.32	6.97							
RD6.8EB1	6.32	6.59	20	8	20	120	0.5	0.5	5
RD6.8EB2	6.52	6.79							
RD6.8EB3	6.70	6.97							
RD7.5EB	6.88	7.64	20	8	20	120	0.5	0.5	5
RD7.5EB1	6.88	7.19							
RD7.5EB2	7.11	7.41							
RD7.5EB3	7.33	7.64	20	8	20	120	0.5	0.5	5
RD8.2EB	7.56	8.41							
RD8.2EB1	7.56	7.90							
RD8.2EB2	7.82	8.15	20	8	20	120	0.5	0.5	5
RD8.2EB3	8.07	8.41							

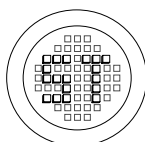

SEMTECH ELECTRONICS LTD.

(Subsidiary of Semtech International Holdings Limited, a company listed on the Hong Kong Stock Exchange, Stock Code: 724)

®

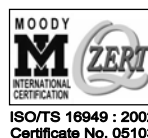

ISO/TS 16949 : 2002 Certificate No. 05103



ISO 14001 Certificate No. 7116



ISO 9001 : 2000 Certificate No. 558-188-A2-R3C-PA

Dated : 05/11/2005

RD2.0E~RD200E

Characteristics at T_a = 25 °C

Type	Zener Voltage			Dynamic Impedance		Knee Dynamic Impedance		Reverse Current	
	V _Z (V) ¹⁾			Z _Z (Ω) ²⁾		Z _{ZK} (Ω) ²⁾		I _R (μA)	
	Min.	Max.	I _Z (mA)	Max.	I _Z (mA)	Max.	I _Z (mA)	Max.	V _R (V)
RD9.1EB	8.33	9.29	20	8	20	120	0.5	0.5	6
RD9.1EB1	8.33	8.70							
RD9.1EB2	8.61	8.99							
RD9.1EB3	8.89	9.29							
RD10EB	9.19	10.30	20	8	20	120	0.5	0.2	7
RD10EB1	9.19	9.59							
RD10EB2	9.48	9.90							
RD10EB3	9.82	10.30							
RD11EB	10.18	11.26	10	10	10	120	0.5	0.2	8
RD11EB1	10.18	10.63							
RD11EB2	10.50	10.95							
RD11EB3	10.82	11.26							
RD12EB	11.13	12.30	10	12	10	110	0.5	0.2	9
RD12EB1	11.13	11.63							
RD12EB2	11.50	11.92							
RD12EB3	11.80	12.30							
RD13EB	12.18	13.62	10	14	10	110	0.5	0.2	10
RD13EB1	12.18	12.71							
RD13EB2	12.59	13.16							
RD13EB3	13.03	13.62							
RD15EB	13.48	15.02	10	16	10	110	0.5	0.2	11
RD15EB1	13.48	14.09							
RD15EB2	13.95	14.56							
RD15EB3	14.42	15.02							
RD16EB	14.87	16.50	10	18	10	150	0.5	0.2	12
RD16EB1	14.87	15.50							
RD16EB2	15.33	15.96							
RD16EB3	15.79	16.50							
RD18EB	16.34	18.30	10	23	10	150	0.5	0.2	13
RD18EB1	16.34	17.06							
RD18EB2	16.90	17.67							
RD18EB3	17.51	18.30							
RD20EB	18.11	20.72	10	28	10	200	0.5	0.2	15
RD20EB1	18.11	18.92							
RD20EB2	18.73	19.57							
RD20EB3	19.38	20.22							
RD20EB4	19.88	20.72	5	30	5	200	0.5	0.2	17
RD22EB	20.23	22.61							
RD22EB1	20.23	21.08							
RD22EB2	20.76	21.65							
RD22EB3	21.22	22.09							
RD22EB4	21.68	22.61	5	35	5	200	0.5	0.2	19
RD24EB	22.26	24.81							
RD24EB1	22.26	23.12							
RD24EB2	22.75	23.73							
RD24EB3	23.29	24.27							
RD24EB4	23.81	24.81	5	45	5	250	0.5	0.2	21
RD27EB	24.26	27.64							
RD27EB1	24.26	25.52							
RD27EB2	24.97	26.26							
RD27EB3	25.63	26.95							
RD27EB4	26.29	27.64	5	55	5	250	0.5	0.2	23
RD30EB	26.99	30.51							
RD30EB1	26.99	28.39							
RD30EB2	27.70	29.13							
RD30EB3	28.36	29.82							
RD30EB4	29.02	30.51							

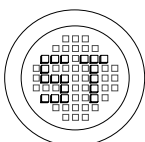

SEMTECH ELECTRONICS LTD.

(Subsidiary of Semtech International Holdings Limited, a company listed on the Hong Kong Stock Exchange, Stock Code: 724)

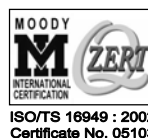

ISO/TS 16949 : 2002
Certificate No. 05103



ISO 14001
Certificate No. 7116



ISO 9001 : 2000
Certificate No. 558-188-A2-R3C-RA

Dated : 05/11/2005

RD2.0E~RD200E

Characteristics at $T_a = 25^\circ\text{C}$

Type	Zener Voltage			Dynamic Impedance		Knee Dynamic Impedance		Reverse Current	
	V_Z (V) ¹⁾			Z_Z (Ω) ²⁾		Z_{ZK} (Ω) ²⁾		I_R (μA)	
	Min.	Max.	I_Z (mA)	Max.	I_Z (mA)	Max.	I_Z (mA)	Max.	V_R (V)
RD33EB	29.68	33.11	5	65	5	250	0.5	0.2	25
RD33EB1	29.68	31.22							
RD33EB2	30.32	31.88							
RD33EB3	30.90	32.50							
RD33EB4	31.49	33.11							
RD36EB	32.14	35.77	5	75	5	250	0.5	0.2	27
RD36EB1	32.14	33.79							
RD36EB2	32.79	34.49							
RD36EB3	33.40	35.13							
RD36EB4	34.01	35.77							
RD39EB	34.68	40.80	5	85	5	250	0.5	0.2	30
RD39EB1	34.68	36.47							
RD39EB2	35.36	37.19							
RD39EB3	36.00	37.85							
RD39EB4	36.63	38.52							
RD39EB5	37.36	39.29							
RD39EB6	38.14	40.11							
RD39EB7	38.94	40.80							
RD43EB	40	45	5	90	5			0.2	33
RD47EB	44	49	5	90	5			0.2	36
RD51EB	48	54	5	110	5			0.2	39
RD56EB	53	60	5	110	5			0.2	43
RD62EB	58	66	2	200	2			0.2	47
RD68EB	64	72	2	200	2			0.2	52
RD75EB	70	79	2	300	2			0.2	57
RD82EB	77	87	2	300	2			0.2	63
RD91EB	85	96	2	400	2			0.2	69
RD100EB	94	106	2	400	2			0.2	76
RD110EB	104	116	1	750	1			0.2	84
RD120EB	114	126	1	900	1			0.2	91
RD130EB	120	140	1	1100	1			0.2	100
RD140EB	130	150	1	1300	1			0.2	110
RD150EB	140	160	1	1500	1			0.2	120
RD160EB	150	170	1	1700	1			0.2	130
RD170EB	160	180	1	1900	1			0.2	140
RD180EB	170	190	1	2200	1			0.2	140
RD190EB	180	200	1	2400	1			0.2	150
RD200EB	190	210	1	2500	1			0.2	160

1) Tested with pulse (20 ms)

2) Z_Z and Z_{ZK} are measured at I_Z by given a very small A.C. Current Signal.

3) Suffix B is Suffix B1, B2, B3, B4, B5, B6 or B7.

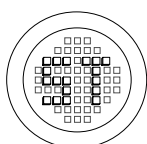

SEMTECH ELECTRONICS LTD.

(Subsidiary of Semtech International Holdings Limited, a company listed on the Hong Kong Stock Exchange, Stock Code: 724)

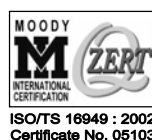

Dated : 05/11/2005

Iz - Vz CHARACTERISTICS

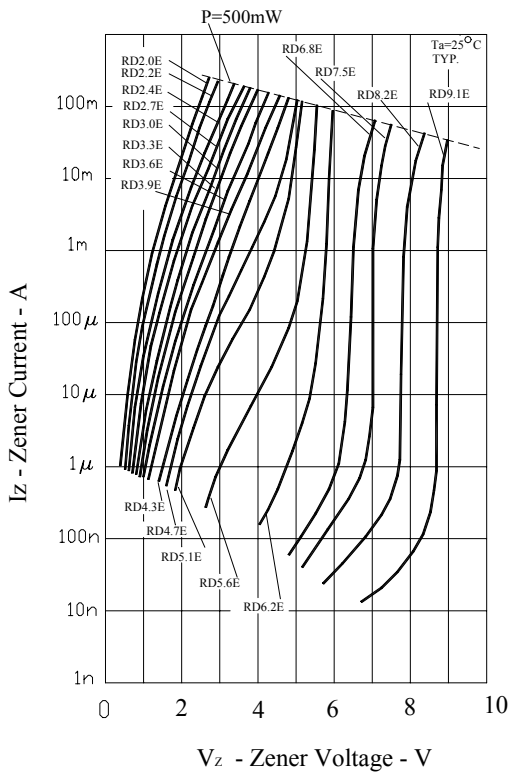

(a)

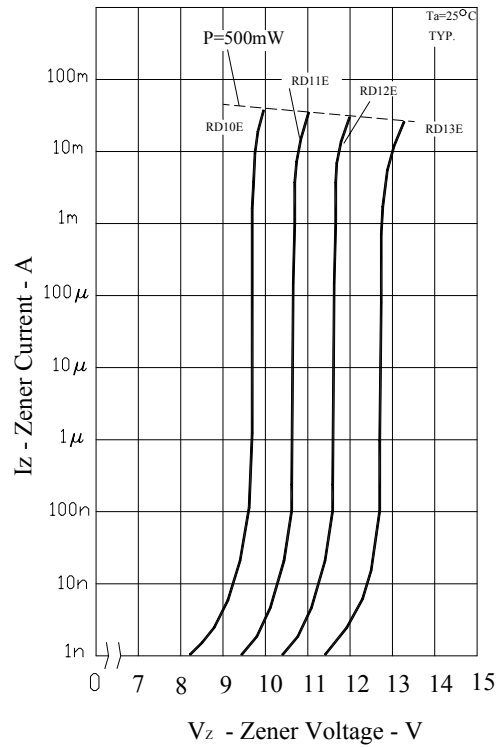

(b)

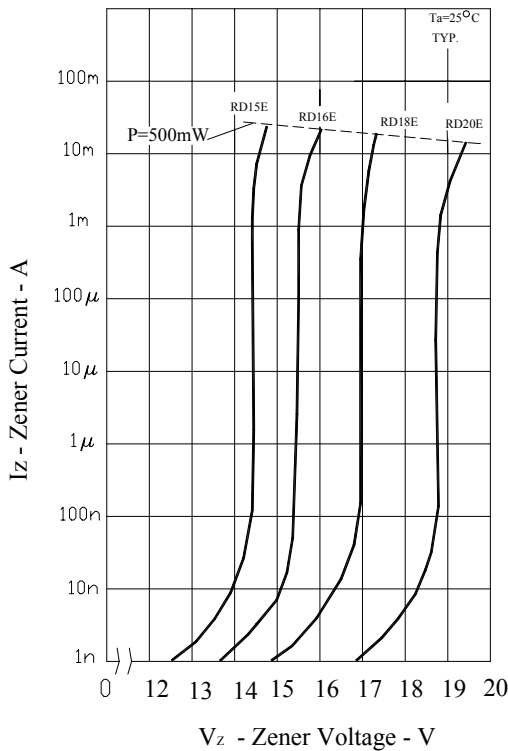

(c)

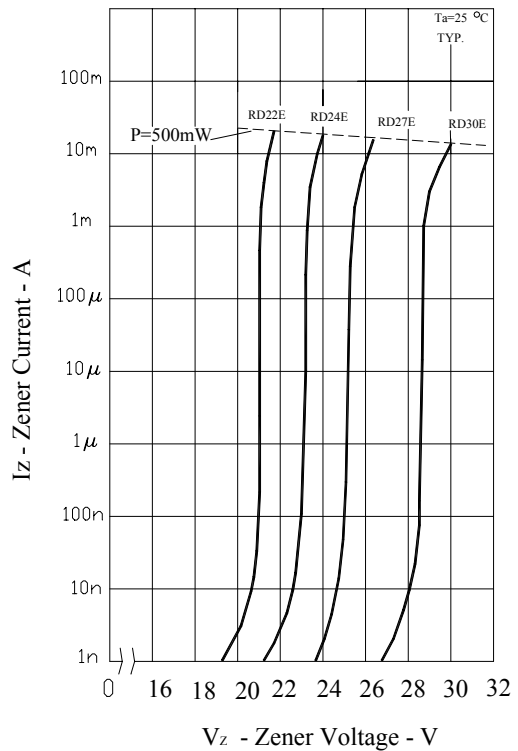

(d)

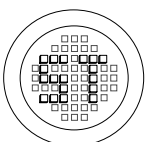

SEMTECH ELECTRONICS LTD.
 (Subsidiary of Semtech International Holdings Limited, a company listed on the Hong Kong Stock Exchange, Stock Code: 724)

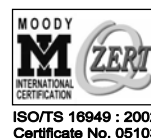

ISO/TS 16949 : 2002
 Certificate No. 05103

ISO 14001
 Certificate No. 7116

ISO 9001 : 2000
 Certificate No. 5558-188-A2-REG-RA

RD2.0E~RD200E

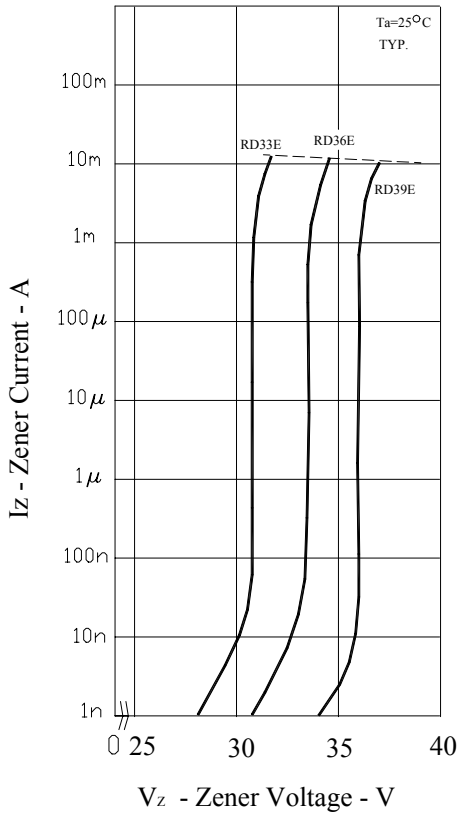

(e)

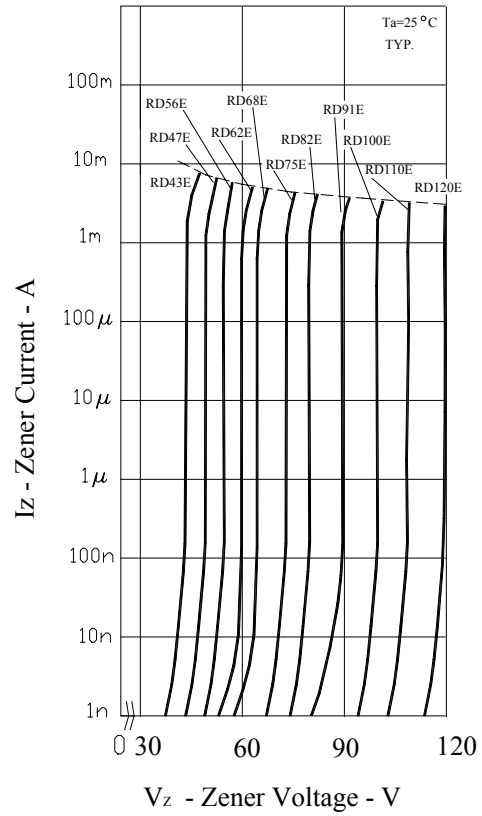

(f)

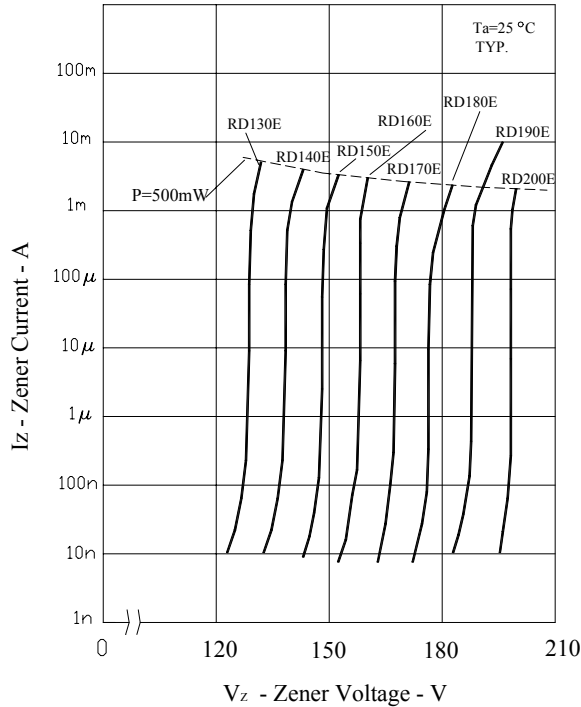

(g)

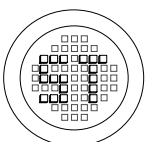

SEMTECH ELECTRONICS LTD.
 (Subsidiary of Semtech International Holdings Limited, a company listed on the Hong Kong Stock Exchange, Stock Code: 724)

®

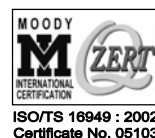

Dated : 05/11/2005

RD2.0E~RD200E

P - Ta Rating

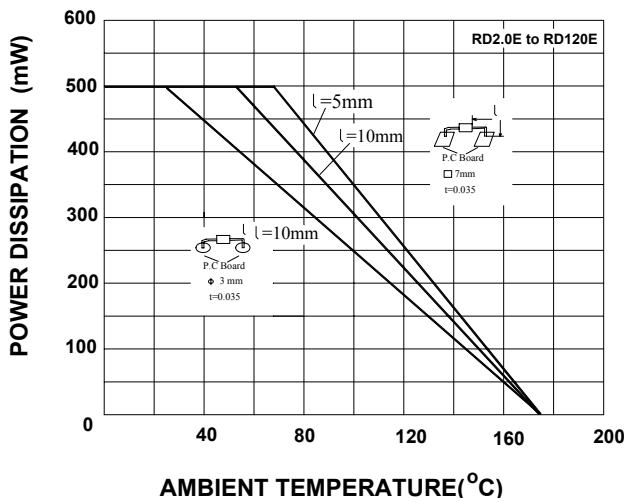

AMBIENT TEMPERATURE(°C)

THERMAL RESISTANCE vs. SIZE OF P. C BOARD

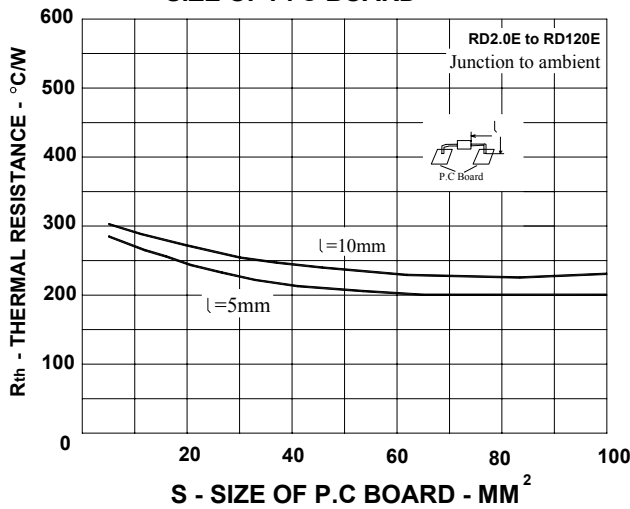

DYNAMIC IMPEDANCE vs. ZENER CURRENT

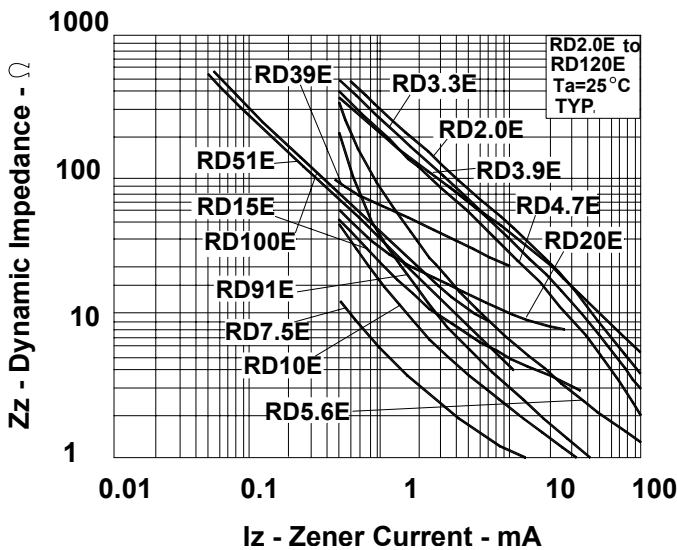

P - Ta Rating

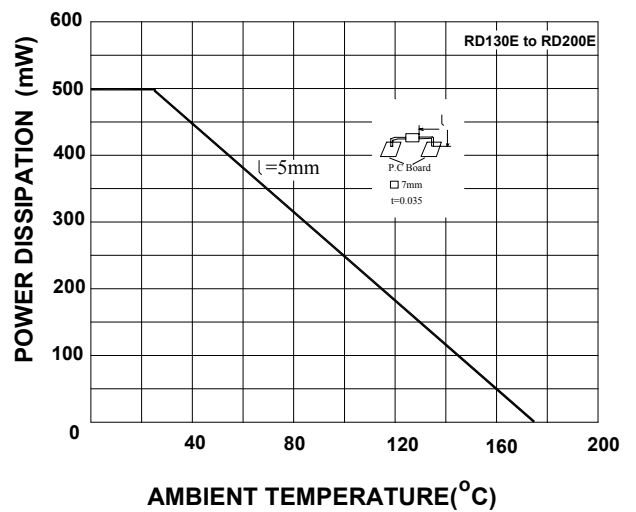

AMBIENT TEMPERATURE(°C)

THERMAL RESISTANCE vs. SIZE OF P. C BOARD

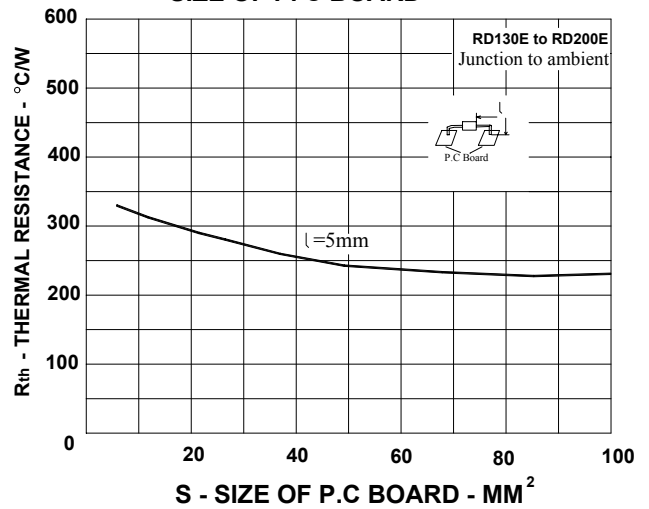

DYNAMIC IMPEDANCE vs. ZENER CURRENT

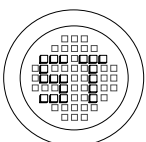
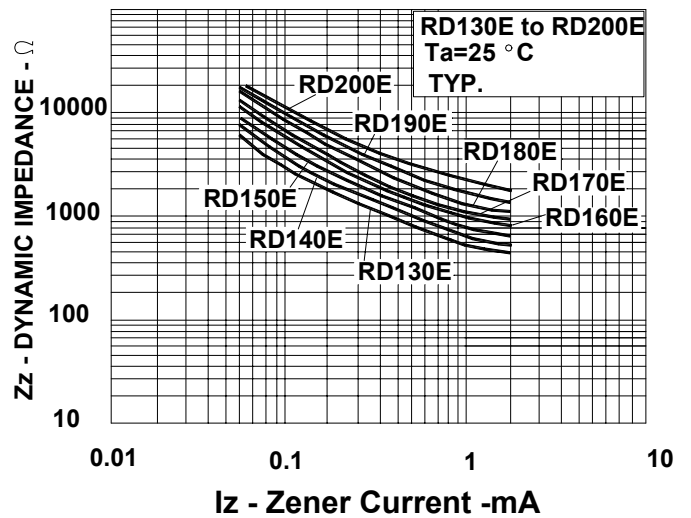

SEMTECH ELECTRONICS LTD.

(Subsidiary of Semtech International Holdings Limited, a company listed on the Hong Kong Stock Exchange, Stock Code: 724)

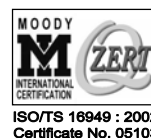

RD2.0E~RD200E

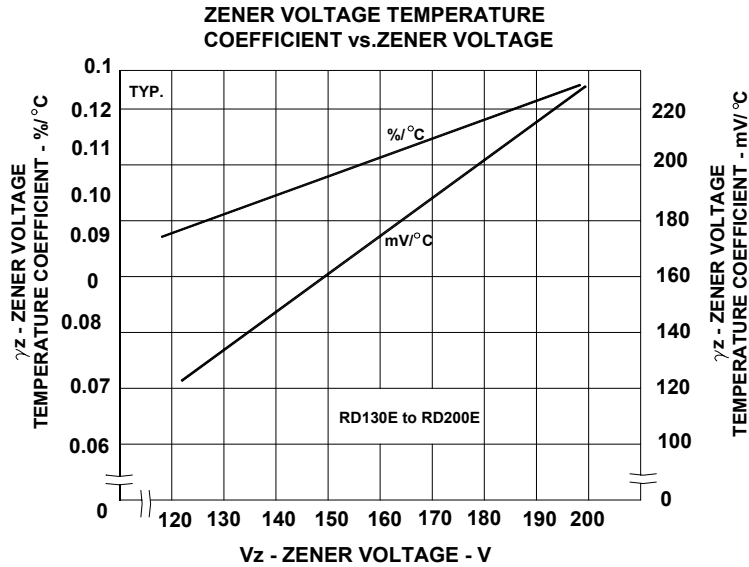
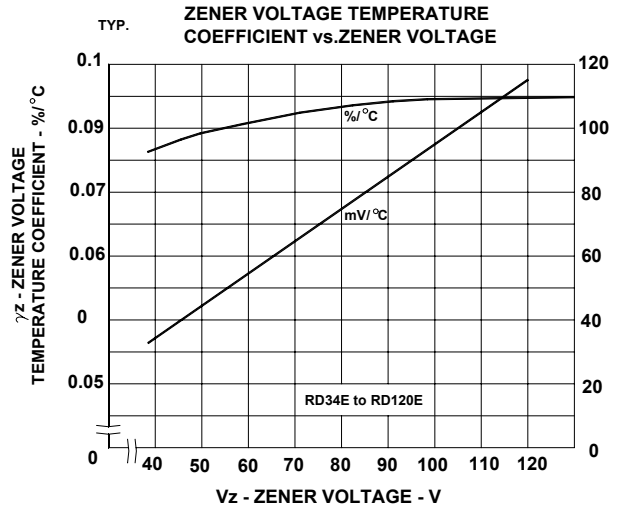
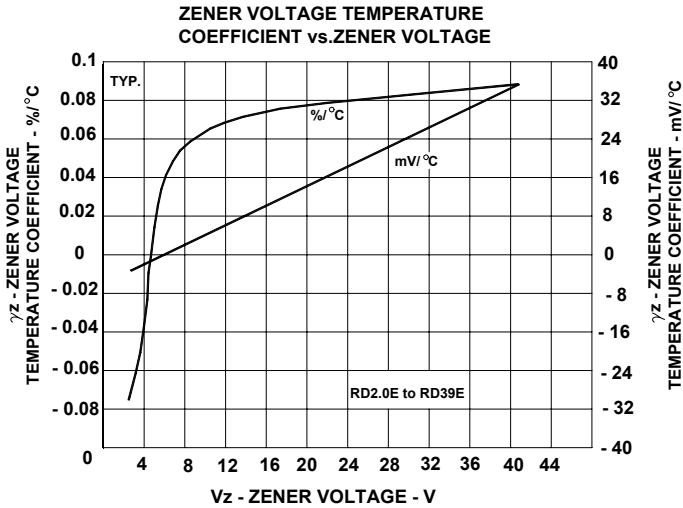

SURGE REVERSE POWER RATINGS

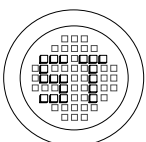
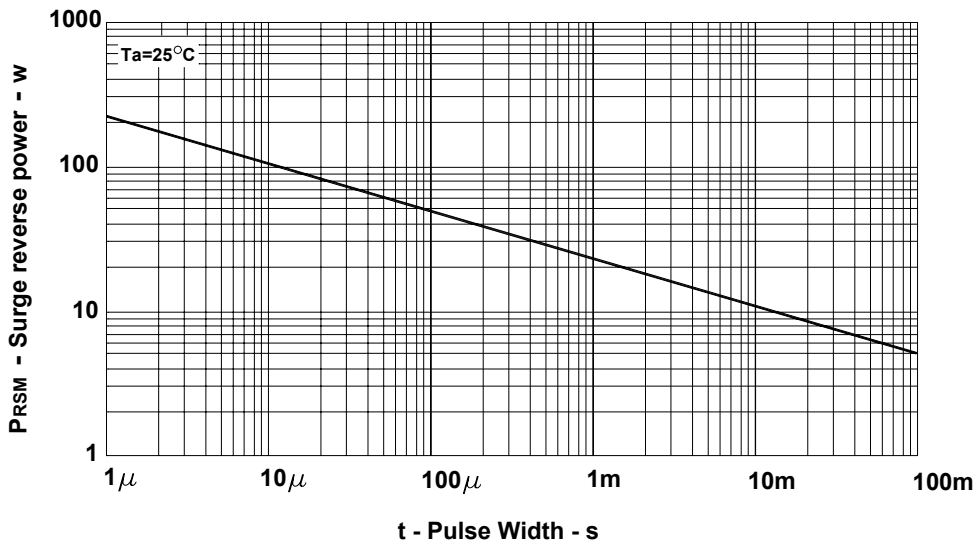

SEMTECH ELECTRONICS LTD.
 (Subsidiary of Semtech International Holdings Limited, a company listed on the Hong Kong Stock Exchange, Stock Code: 724)

®

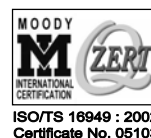

Dated : 05/11/2005