

RD3ST24

Standby Control IC

REJ03D0521-0200
Rev.2.00
Mar 01, 2006

Description

RD3ST24 is including the standby control circuit for a microcomputer in 8 pin packages.

When $\overline{\text{MSTB}}$ input "Low", SWOUT output "Low", $\overline{\text{STBYOUT}}$ output become "High" and cancels standby condition.

And $\overline{\text{RESOUT}}$ output becomes "High" after it passed period ($t1^*$) when it is stable the oscillation that was set up with RC bill outside and cancel the reset condition of a microcomputer.

Also when $\overline{\text{MSTB}}$ input "Low", $\overline{\text{RESOUT}}$ output becomes "Low" and makes reset condition.

After the delay time ($t2$) of prescription passed subsequently, SWOUT output "High" $\overline{\text{STBYOUT}}$ output becomes "Low" and makes a microcomputer standby condition.

*: $t1 = K \cdot RC$ (K is coefficient: Reference of application data)

Features

- Supply voltage range: 2.3 to 5.5 V
- Temperature range: -40 to +85°C
- Output current: $\pm 6\text{mA}$ (@ $V_{CC}=3.0\text{V}$), $\pm 12\text{mA}$ (@ $V_{CC}=4.5\text{V}$)
- Ordering Information

Part Name	Package Type	Package Code (Previous Code)	Package Abbreviation	Taping Abbreviation (Quantity)
RD3ST24USE	SSOP-8 pin	PVSP0008KA-A (TTP-8DBV)	US	E (3,000 pcs/reel)

Outline and Article Indication

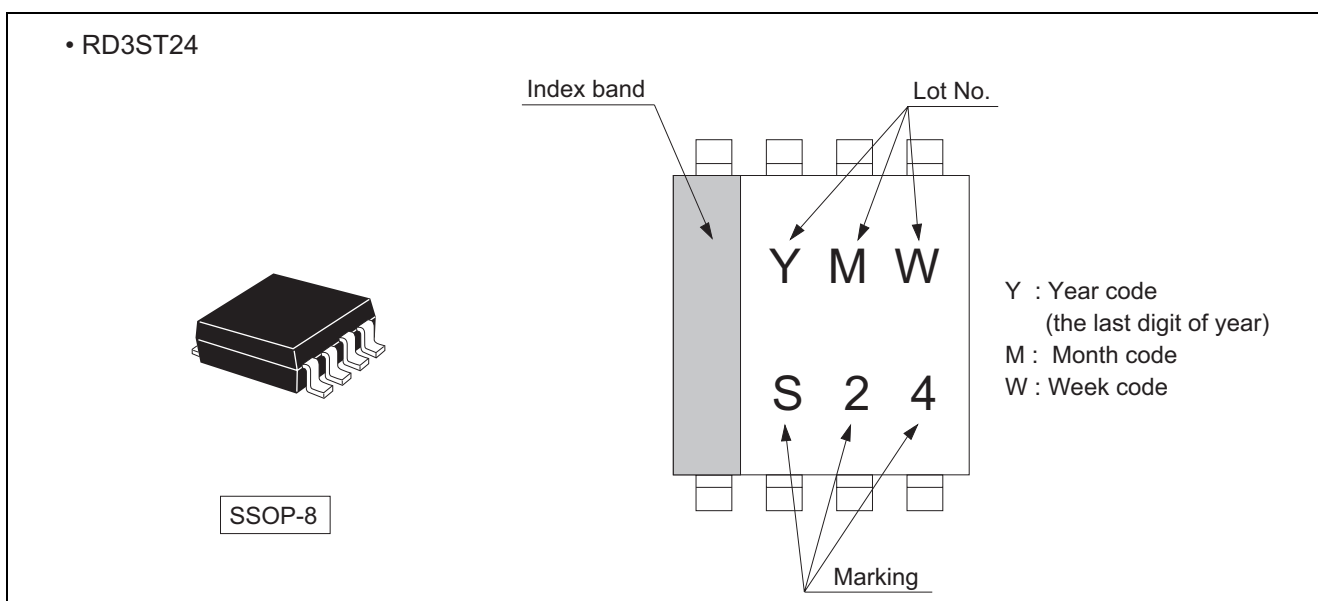

Pin Arrangement

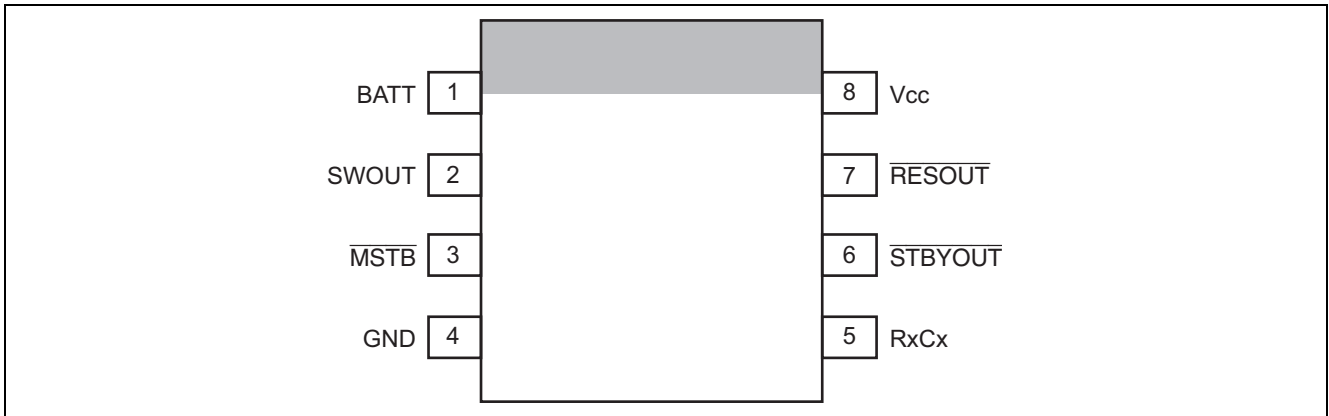

Pin Description

Symbol	Pin Name
BATT	The battery power supply
SWOUT	Output for Power MOS FET control
MSTB	Manual standby Input
GND	Ground
R _x C _x	Terminal for external resistance and capacitance
STBYOUT	Standby Output
RESOUT	Reset Output
V _{CC}	Power supply

Absolute Maximum Ratings

Item	Symbol	Ratings	Unit	Test Conditions
Supply voltage range	V_{CC}	-0.5 to 7.0	V	
Input voltage range ^{*1}	V_I	-0.5 to $V_{CC} + 0.5$	V	
Output voltage range ^{*1, 2}	V_O	-0.5 to $V_{CC} + 0.5$	V	Output: H or L
		-0.5 to 7.0		V_{CC} : OFF
Input clamp current	I_{IK}	± 20	mA	$V_I < 0$
Output clamp current	I_{OK}	± 50	mA	$V_O < 0$ or $V_O > V_{CC}$
Continuous output current	I_O	± 25	mA	$V_O = 0$ to V_{CC}
Continuous current through V_{CC} or GND	I_{CC} or I_{GND}	± 50	mA	
Maximum power dissipation at $T_a = 25^\circ\text{C}$ (in still air) ^{*3}	P_T	200	mW	
Storage temperature	T_{stg}	-65 to 150	$^\circ\text{C}$	

Notes: The absolute maximum ratings are values, which must not individually be exceeded, and furthermore no two of which may be realized at the same time.

1. The input and output voltage ratings may be exceeded if the input and output clamp-current ratings are observed.
2. This value is limited to 6.0 V maximum.
3. The maximum package power dissipation was calculated using a junction temperature of 150 $^\circ\text{C}$.

Recommended Operating Conditions

Item	Symbol	Min	Typ	Max	Unit	Conditions
Supply voltage range	V_{CC} , BATT	2.3	—	5.5	V	
Input voltage range	V_I	0.0	—	V_{CC}	V	
Output voltage range	V_O	0.0	—	5.5	V	
Output current	I_{OH}	—	—	-6	mA	$V_{CC} = 3.0\text{ V to }3.6\text{ V}$
		—	—	-12		$V_{CC} = 4.5\text{ V to }5.5\text{ V}$
	I_{OL}	—	—	6	$V_{CC} = 3.0\text{ V to }3.6\text{ V}$	
		—	—	12	$V_{CC} = 4.5\text{ V to }5.5\text{ V}$	
External resistance	R_X	1.0	—	—	k Ω	
External capacitance	C_X	—	Unlimited	—	F	
Operating free-air temperature	T_a	-40	—	85	$^\circ\text{C}$	

Electrical Characteristic

Ta = -40 to 85°C

Item	Symbol	V _{CC} (V)	BATT (V)	Min	Typ	Max	Unit	Test condition
Input voltage	V _{IH}	2.5±0.2		0.7×V _{CC}	—	—	V	
		3.3±0.3		0.7×V _{CC}	—	—		
		5.0±0.5		0.7×V _{CC}	—	—		
	V _{IL}	2.5±0.2		—	—	0.3×V _{CC}	V	
		3.3±0.3		—	—	0.3×V _{CC}		
		5.0±0.5		—	—	0.3×V _{CC}		
Output voltage	V _{OH}	3.0	3.0	2.9	—	—	V	I _{OH} =-100μA
				2.48	—	—		I _{OH} =-6mA
		4.5	4.5	4.4	—	—		I _{OH} =-100μA
				3.8	—	—		I _{OH} =-12mA
	V _{OL}	3.0	3.0	—	—	0.1	V	I _{OL} =100μA
				—	—	0.44		I _{OL} =6mA
		4.5	4.5	—	—	0.1		I _{OL} =100μA
				—	—	0.55		I _{OL} =12mA
Input current	I _{IN}	5.5	5.5	—	—	±10	μA	V _{IN} =0V or V _{CC} , R _X C _X =GND
Output leakage current	I _{OFF}	0	0	—	—	±10	μA	V _O =5.5V, R _X C _X =GND (RESOUT, STBYOUT, SWOUT)
Quiescent supply current	I _{CC}	5.5	5.5	—	—	±10	μA	V _{IN} =0V or V _{CC} , R _X C _X =GND
	I _{CC} (BATT)	5.5	5.5	—	—	±10	uA	
		0	5.5	—	—	±10	uA	

Switching Characteristics

Ta = -40 to 85°C

Item	Symbol	V _{CC} (V) *1	BATT (V)	Min	Typ	Max	Unit	Test condition
Propagation delay time	t1	3.3	3.3	80	95	110	μs	R _X =10kΩ, C _X =0.01μF
				0.8	0.95	1.1	ms	R _X =10kΩ, C _X =0.1μF
				80	95	110	ms	R _X =100kΩ, C _X =1.0μF
		5.0	5.0	80	95	110	μs	R _X =10kΩ, C _X =0.01μF
				0.8	0.95	1.1	ms	R _X =10kΩ, C _X =0.1μF
				80	95	110	ms	R _X =100kΩ, C _X =1.0μF
	t2	3.3	3.3	125	—	250	ns	
		5.0	5.0	70	—	160	ns	

Note: 1. Ta = 25°C

Timing Diagram

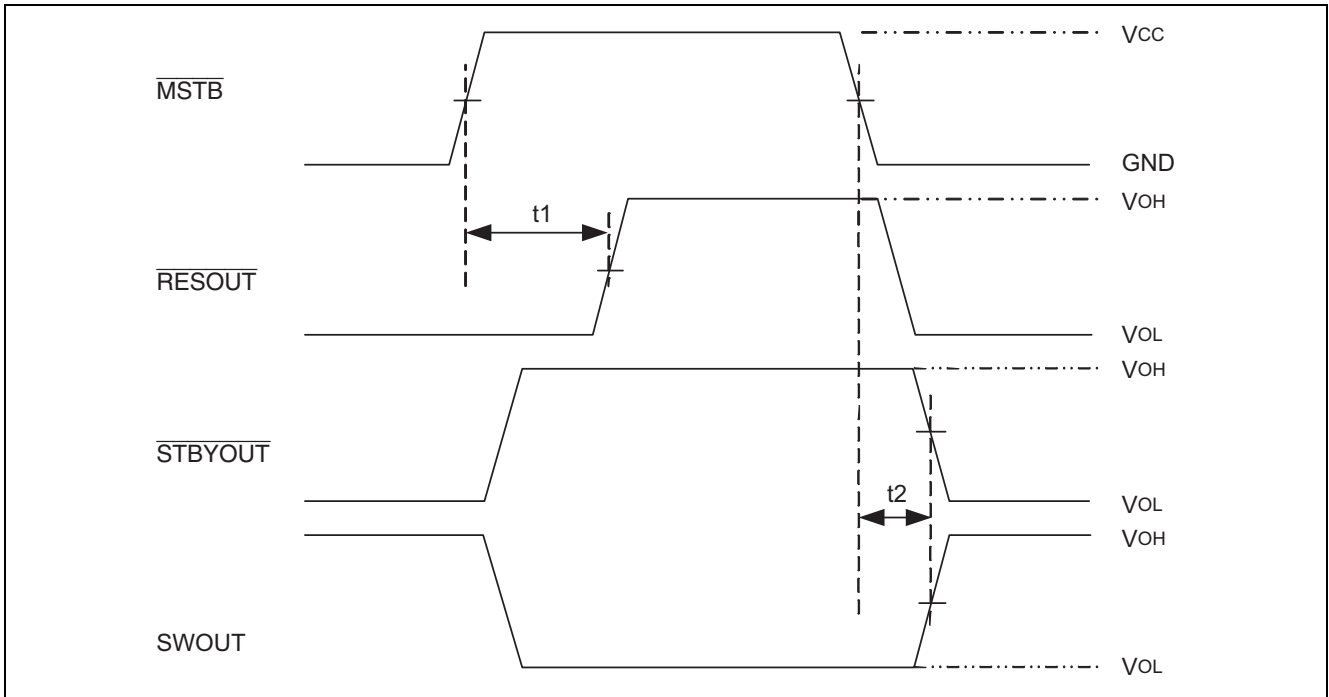

Application Circuit

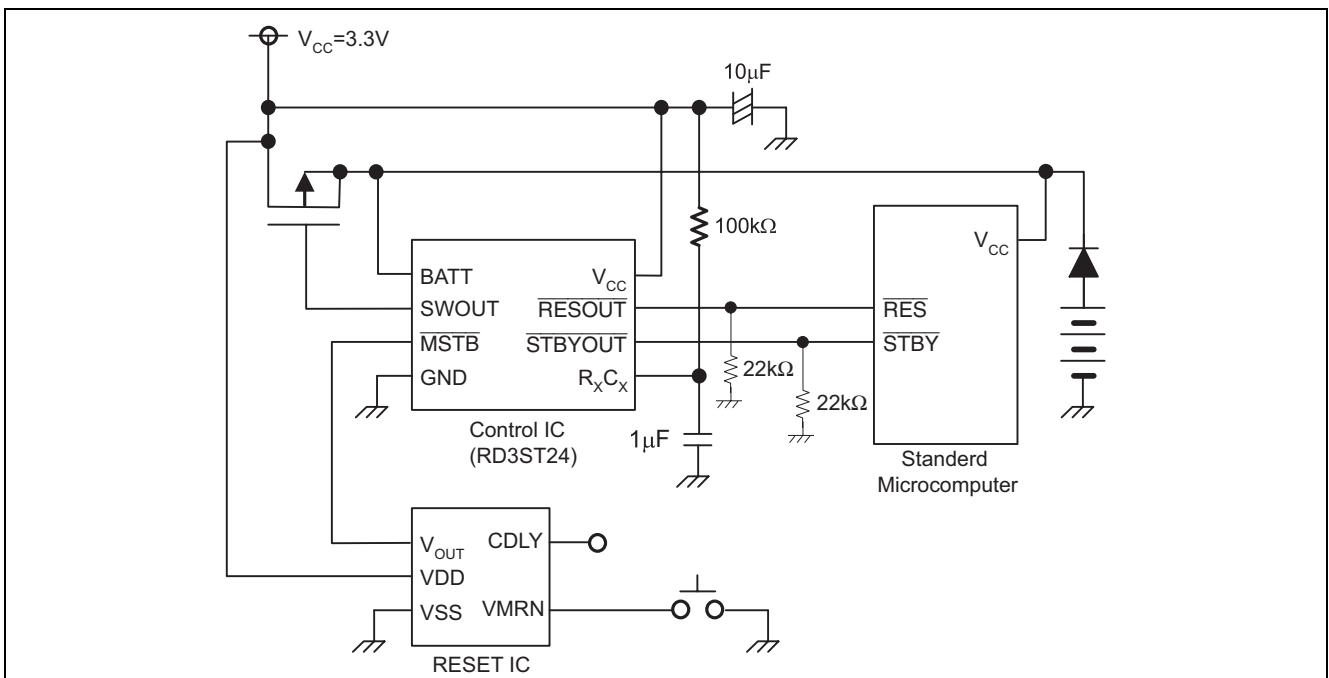

- Notes: 1. CDLY terminal of RESET IC becomes shortest that delay time the setting.
 2. V_{OUT} of RESET IC is not connected to a direct microcomputer.

Application Data

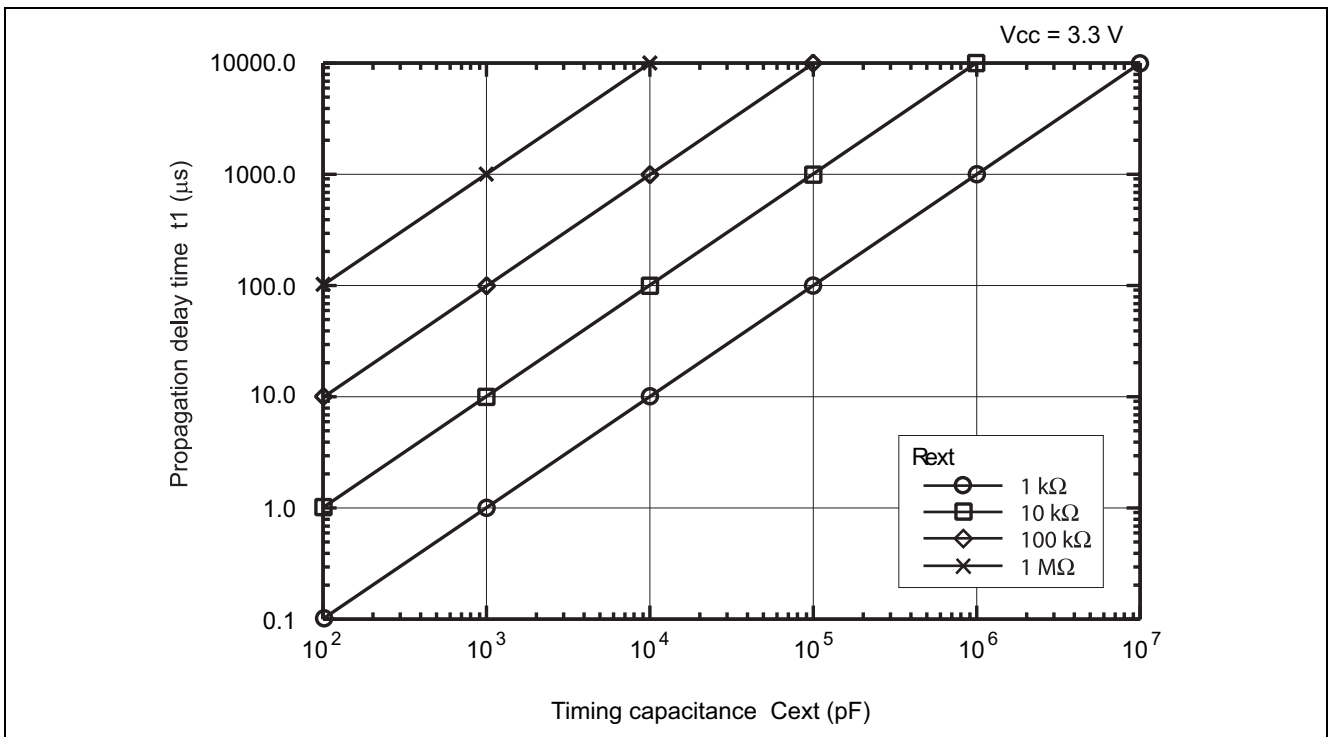
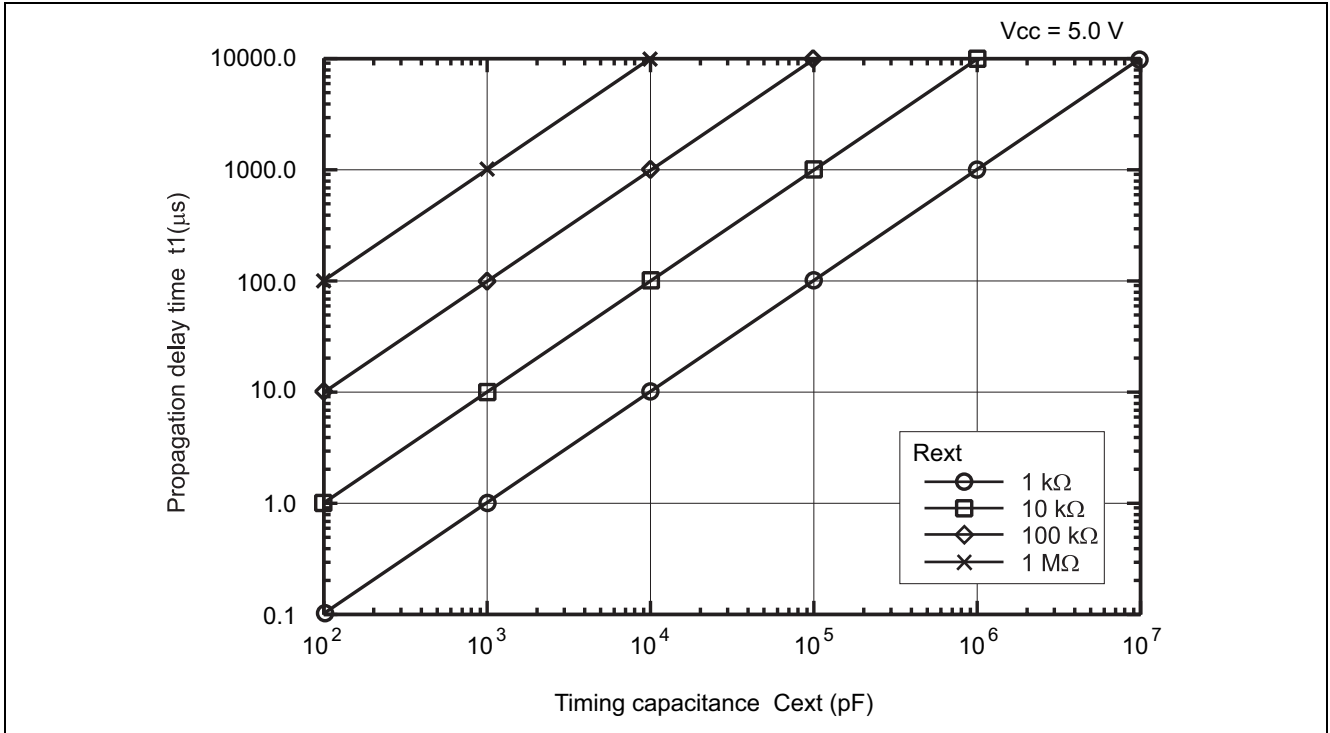

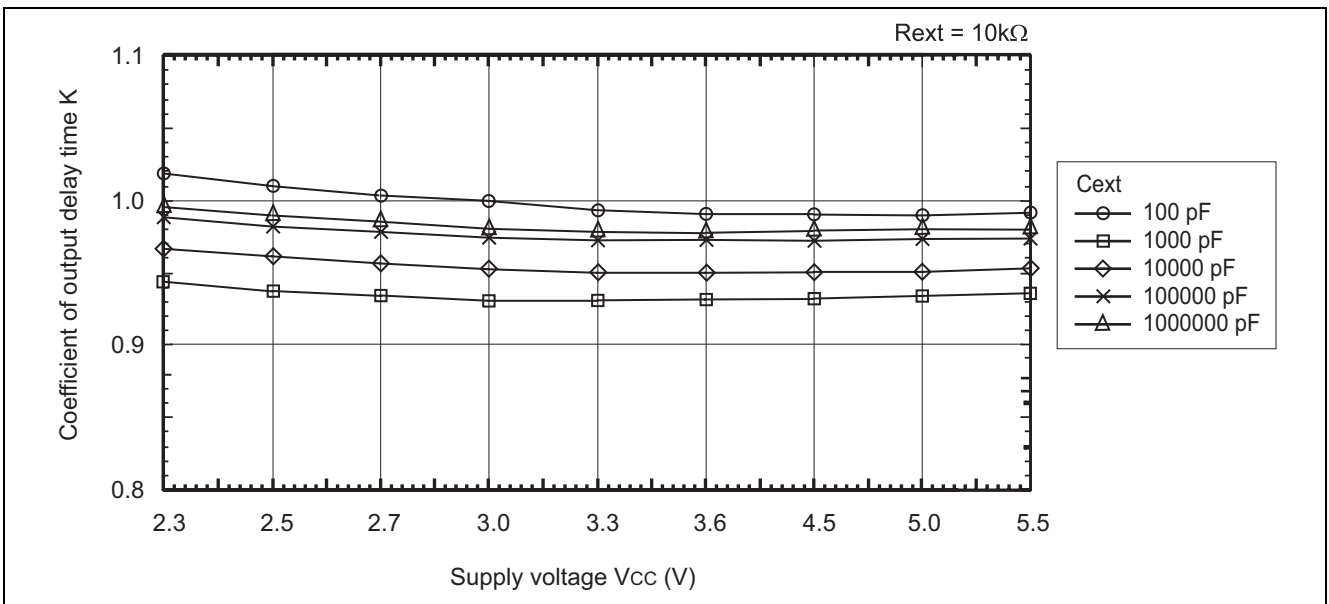
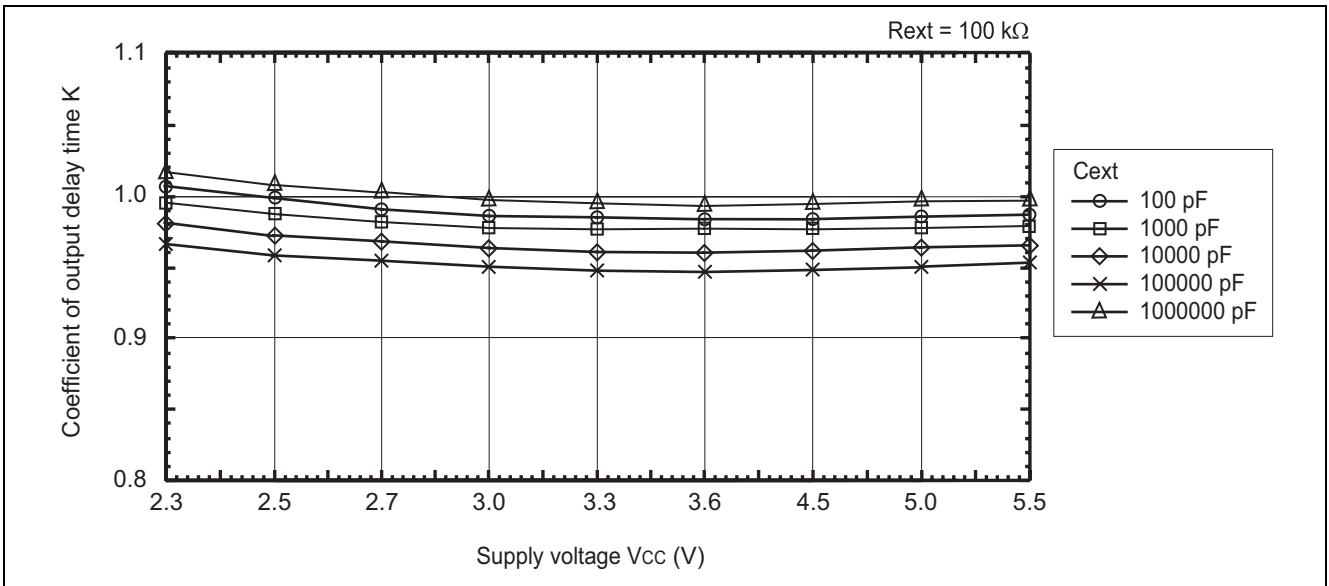

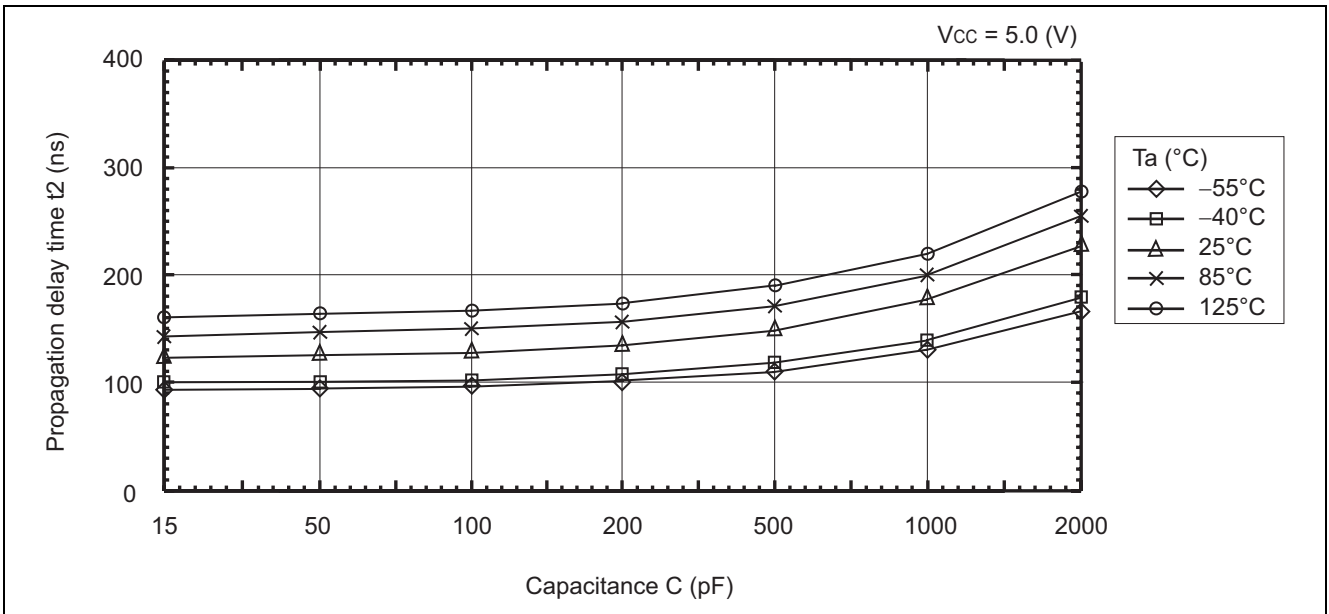
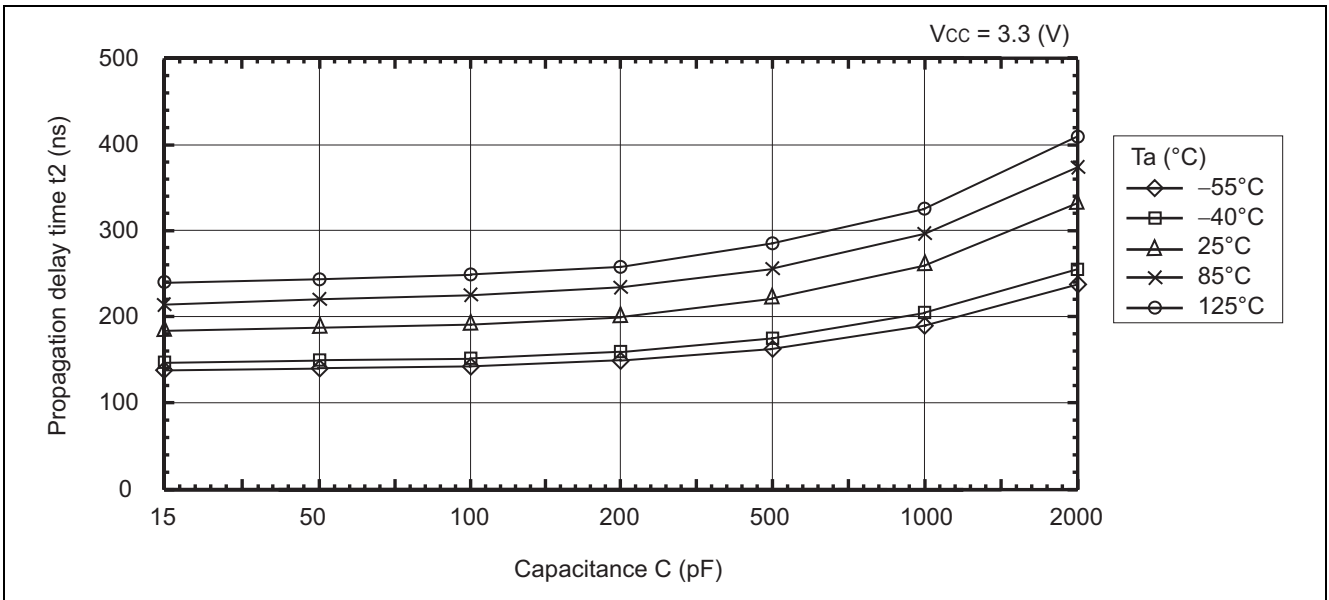

Package Dimensions

JEITA Package Code	RENESAS Code	Previous Code	MASS[Typ.]
P-VSSOP8-2.3x2-0.50	PVSP0008KA-A	TTP-8DB/TTP-8DBV	0.010g

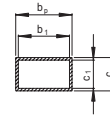
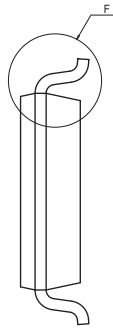
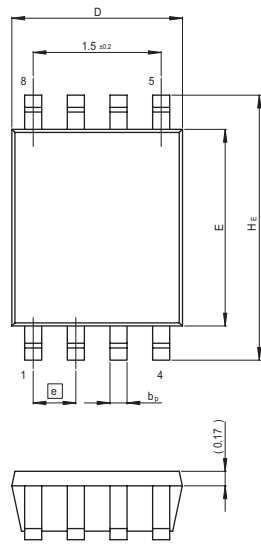

Terminal cross section

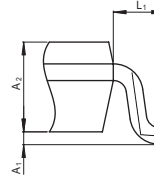

Detail F

Reference Symbol	Dimension in Millimeters		
	Min	Nom	Max
D	1.8	2.0	2.2
E	2.2	2.3	2.4
A ₂	0.6	0.7	0.8
A ₁	0	—	0.1
A	—	—	—
b _p	0.15	0.22	0.3
b ₁	—	0.20	—
c	0.08	0.13	0.23
c ₁	—	0.11	—
θ	—	—	—
H _E	2.8	3.1	3.4
ⓐ	—	(0.5)	—
x	—	—	—
y	—	—	—
Z	—	—	—
L	—	—	—
L ₁	—	(0.4)	—

Keep safety first in your circuit designs!

1. Renesas Technology Corp. puts the maximum effort into making semiconductor products better and more reliable, but there is always the possibility that trouble may occur with them. Trouble with semiconductors may lead to personal injury, fire or property damage.
Remember to give due consideration to safety when making your circuit designs, with appropriate measures such as (i) placement of substitutive, auxiliary circuits, (ii) use of nonflammable material or (iii) prevention against any malfunction or mishap.

Notes regarding these materials

1. These materials are intended as a reference to assist our customers in the selection of the Renesas Technology Corp. product best suited to the customer's application; they do not convey any license under any intellectual property rights, or any other rights, belonging to Renesas Technology Corp. or a third party.
 2. Renesas Technology Corp. assumes no responsibility for any damage, or infringement of any third-party's rights, originating in the use of any product data, diagrams, charts, programs, algorithms, or circuit application examples contained in these materials.
 3. All information contained in these materials, including product data, diagrams, charts, programs and algorithms represents information on products at the time of publication of these materials, and are subject to change by Renesas Technology Corp. without notice due to product improvements or other reasons. It is therefore recommended that customers contact Renesas Technology Corp. or an authorized Renesas Technology Corp. product distributor for the latest product information before purchasing a product listed herein.
The information described here may contain technical inaccuracies or typographical errors.
Renesas Technology Corp. assumes no responsibility for any damage, liability, or other loss rising from these inaccuracies or errors.
Please also pay attention to information published by Renesas Technology Corp. by various means, including the Renesas Technology Corp. Semiconductor home page (<http://www.renesas.com>).
 4. When using any or all of the information contained in these materials, including product data, diagrams, charts, programs, and algorithms, please be sure to evaluate all information as a total system before making a final decision on the applicability of the information and products. Renesas Technology Corp. assumes no responsibility for any damage, liability or other loss resulting from the information contained herein.
 5. Renesas Technology Corp. semiconductors are not designed or manufactured for use in a device or system that is used under circumstances in which human life is potentially at stake. Please contact Renesas Technology Corp. or an authorized Renesas Technology Corp. product distributor when considering the use of a product contained herein for any specific purposes, such as apparatus or systems for transportation, vehicular, medical, aerospace, nuclear, or undersea repeater use.
 6. The prior written approval of Renesas Technology Corp. is necessary to reprint or reproduce in whole or in part these materials.
 7. If these products or technologies are subject to the Japanese export control restrictions, they must be exported under a license from the Japanese government and cannot be imported into a country other than the approved destination.
Any diversion or reexport contrary to the export control laws and regulations of Japan and/or the country of destination is prohibited.
 8. Please contact Renesas Technology Corp. for further details on these materials or the products contained therein.
-



RENESAS SALES OFFICES

<http://www.renesas.com>

Refer to "<http://www.renesas.com/en/network>" for the latest and detailed information.

Renesas Technology America, Inc.

450 Holger Way, San Jose, CA 95134-1368, U.S.A
Tel: <1> (408) 382-7500, Fax: <1> (408) 382-7501

Renesas Technology Europe Limited

Dukes Meadow, Millboard Road, Bourne End, Buckinghamshire, SL8 5FH, U.K.
Tel: <44> (1628) 585-100, Fax: <44> (1628) 585-900

Renesas Technology (Shanghai) Co., Ltd.

Unit 204, 205, AZIAcenter, No.1233 Lujiazui Ring Rd, Pudong District, Shanghai, China 200120
Tel: <86> (21) 5877-1818, Fax: <86> (21) 6887-7898

Renesas Technology Hong Kong Ltd.

7th Floor, North Tower, World Finance Centre, Harbour City, 1 Canton Road, Tsimshatsui, Kowloon, Hong Kong
Tel: <852> 2265-6688, Fax: <852> 2730-6071

Renesas Technology Taiwan Co., Ltd.

10th Floor, No.99, Fushing North Road, Taipei, Taiwan
Tel: <886> (2) 2715-2888, Fax: <886> (2) 2713-2999

Renesas Technology Singapore Pte. Ltd.

1 Harbour Front Avenue, #06-10, Keppel Bay Tower, Singapore 098632
Tel: <65> 6213-0200, Fax: <65> 6278-8001

Renesas Technology Korea Co., Ltd.

Kukje Center Bldg. 18th Fl., 191, 2-ka, Hangang-ro, Yongsan-ku, Seoul 140-702, Korea
Tel: <82> (2) 796-3115, Fax: <82> (2) 796-2145

Renesas Technology Malaysia Sdn. Bhd

Unit 906, Block B, Menara Amcorp, Amcorp Trade Centre, No.18, Jalan Persiaran Barat, 46050 Petaling Jaya, Selangor Darul Ehsan, Malaysia
Tel: <603> 7955-9390, Fax: <603> 7955-9510