

ELECTROSTATIC SENSITIVE DEVICE
OBSERVE HANDLING PRECAUTIONS

MITSUBISHI RF POWER MOS FET

RD70HVF1

RoHS Compliance, Silicon MOSFET Power Transistor, 175MHz70W 520MHz,50W

DESCRIPTION

RD70HVF1 is a MOS FET type transistor specifically designed for VHF/UHF High power amplifiers applications.

FEATURES

High power and High Gain:
 $P_{out} > 70W$, $G_p > 10.6dB$ @ $V_{dd} = 12.5V$, $f = 175MHz$
 $P_{out} > 50W$, $G_p > 7.0dB$ @ $V_{dd} = 12.5V$, $f = 520MHz$
 High Efficiency: 60%typ.on VHF Band
 High Efficiency: 55%typ.on UHF Band

APPLICATION

For output stage of high power amplifiers in VHF/UHF Band mobile radio sets.

RoHS COMPLIANT

RD70HVF1-101 is a RoHS compliant products.
 RoHS compliance is indicate by the letter "G" after the Lot Marking.

ABSOLUTE MAXIMUM RATINGS

($T_c = 25^\circ C$ UNLESS OTHERWISE NOTED)

SYMBOL	PARAMETER	CONDITIONS	RATINGS	UNIT
V_{DSS}	Drain to source voltage	$V_{GS} = 0V$	30	V
V_{GSS}	Gate to source voltage	$V_{DS} = 0V$	+/-20	V
P_{ch}	Channel dissipation	$T_c = 25^\circ C$	150	W
P_{in}	Input power	$Z_g = Z_l = 50\Omega$	10(Note2)	W
I_D	Drain current	-	20	A
T_{ch}	Channel temperature	-	175	$^\circ C$
T_{stg}	Storage temperature	-	-40 to +175	$^\circ C$
$R_{th j-c}$	Thermal resistance	junction to case	1.0	$^\circ C/W$

Note 1: Above parameters are guaranteed independently.

Note 2: Over 300MHz use spec is 20W

ELECTRICAL CHARACTERISTICS ($T_c = 25^\circ C$, UNLESS OTHERWISE NOTED)

SYMBOL	PARAMETER	CONDITIONS	LIMITS			UNIT
			MIN	TYP	MAX.	
I_{DSS}	Zerogate voltage drain current	$V_{DS} = 17V$, $V_{GS} = 0V$	-	-	300	μA
I_{GSS}	Gate to source leak current	$V_{GS} = 10V$, $V_{DS} = 0V$	-	-	5	μA
V_{TH}	Gate threshold voltage	$V_{DS} = 12V$, $I_{DS} = 1mA$	1.3	1.8	2.3	V
P_{out}	Output power	$f = 175MHz$, $V_{DD} = 12.5V$	70	75	-	W
η_D	Drain efficiency	$P_{in} = 6W$, $I_{dq} = 2.0A$	55	60	-	%
P_{out}	Output power	$f = 520MHz$, $V_{DD} = 12.5V$	50	55	-	W
η_D	Drain efficiency	$P_{in} = 10W$, $I_{dq} = 2.0A$	50	55	-	%
	Load VSWR tolerance	$V_{DD} = 15.2V$, $P_o = 70W$ (PinControl) $f = 175MHz$, $I_{dq} = 2.0A$, $Z_g = 50\Omega$ Load VSWR=20:1(All phase)	No destroy			-
	Load VSWR tolerance	$V_{DD} = 15.2V$, $P_o = 50W$ (PinControl) $f = 520MHz$, $I_{dq} = 2.0A$, $Z_g = 50\Omega$ Load VSWR=20:1(All phase)	No destroy			-

Note : Above parameters , ratings , limits and conditions are subject to change.

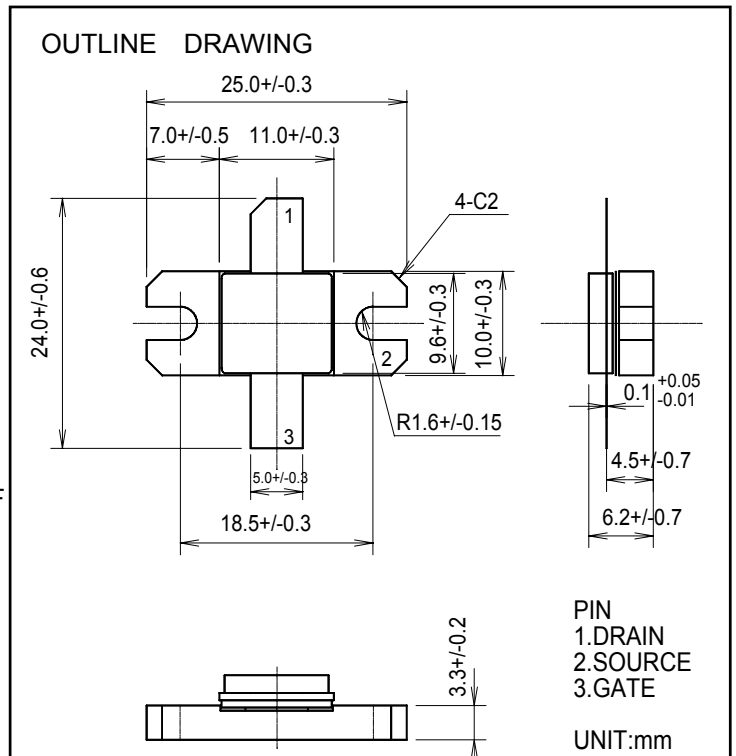



ELECTROSTATIC SENSITIVE DEVICE
OBSERVE HANDLING PRECAUTIONS

MITSUBISHI RF POWER MOS FET

RD70HVF1

RoHS Compliance, Silicon MOSFET Power Transistor, 175MHz70W 520MHz,50W

TYPICAL CHARACTERISTICS

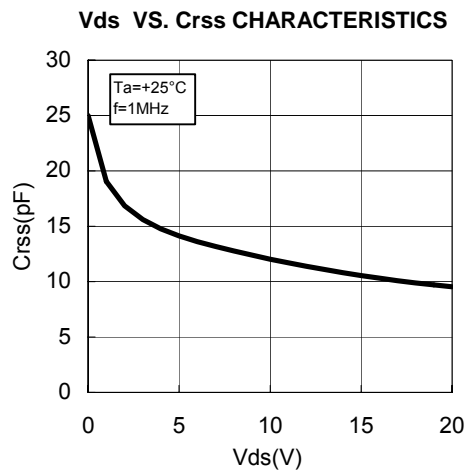
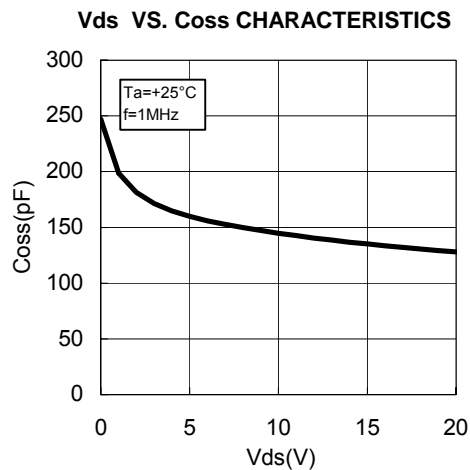
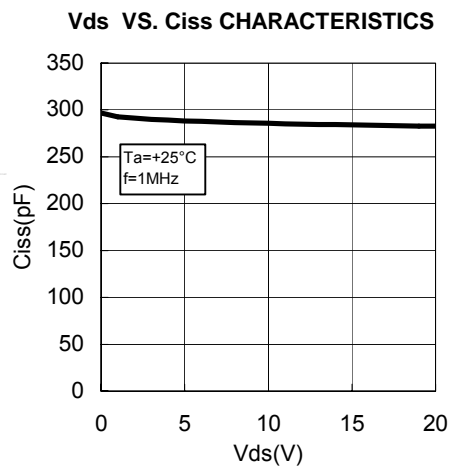
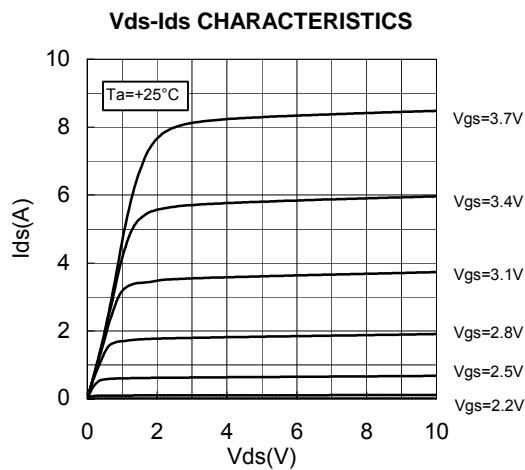
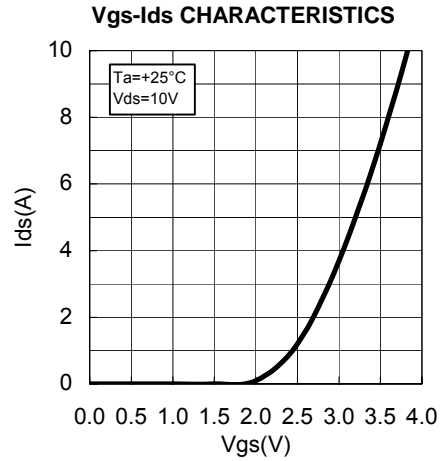
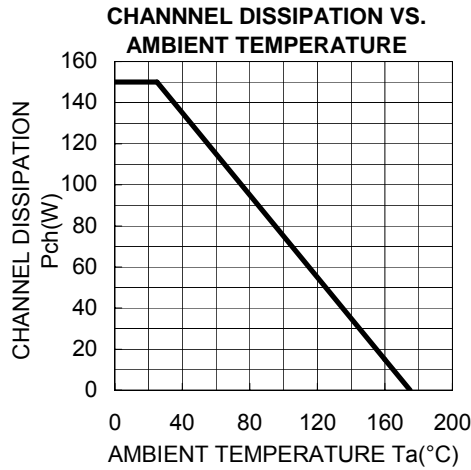

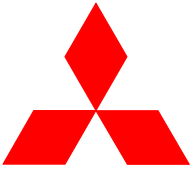

ELECTROSTATIC SENSITIVE DEVICE
OBSERVE HANDLING PRECAUTIONS

MITSUBISHI RF POWER MOS FET

RD70HVF1

RoHS Compliance, Silicon MOSFET Power Transistor, 175MHz70W 520MHz,50W

TYPICAL CHARACTERISTICS

Pin-Po CHARACTERISTICS @f=175MHz

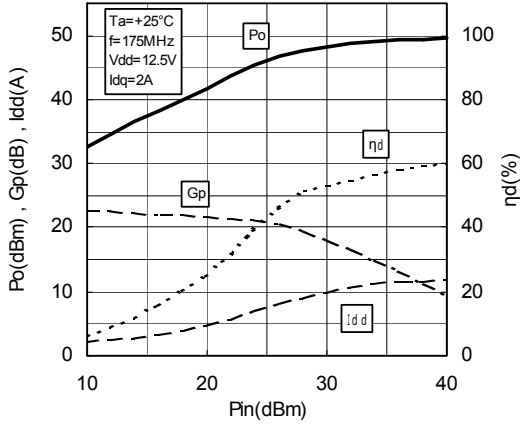

Pin-Po CHARACTERISTICS @f=175MHz

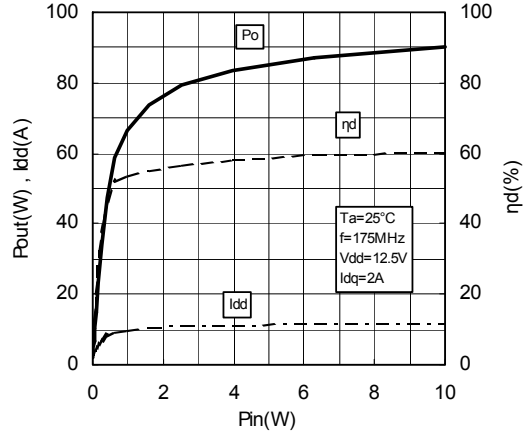

Pin-Po CHARACTERISTICS @f=520MHz

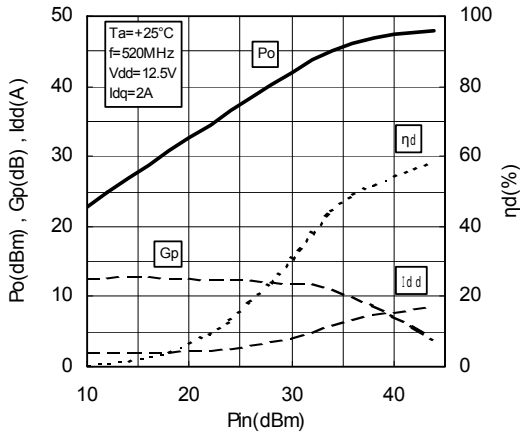

Pin-Po CHARACTERISTICS @f=520MHz

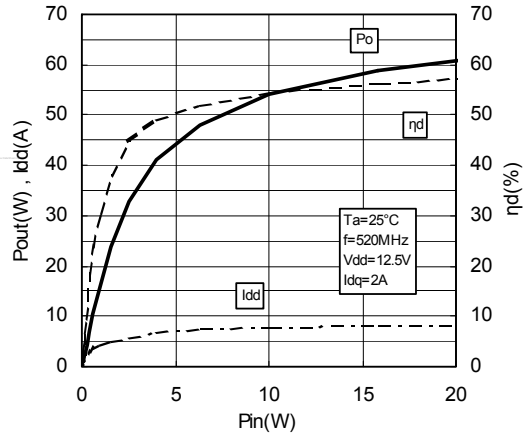

Vdd-Po CHARACTERISTICS @f=175MHz

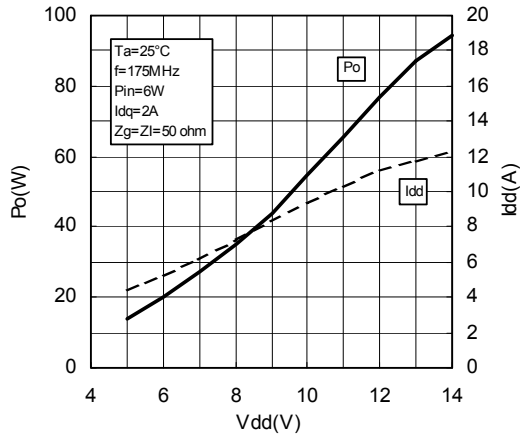

Vdd-Po CHARACTERISTICS @f=520MHz

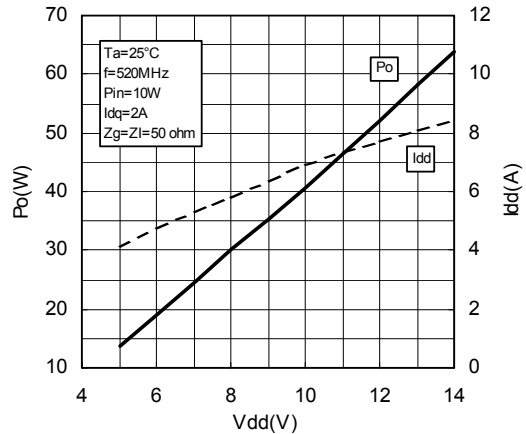

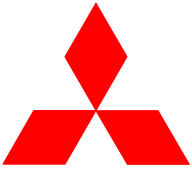

ELECTROSTATIC SENSITIVE DEVICE
OBSERVE HANDLING PRECAUTIONS

MITSUBISHI RF POWER MOS FET

RD70HVF1

RoHS Compliance, Silicon MOSFET Power Transistor, 175MHz70W 520MHz,50W

TYPICAL CHARACTERISTICS

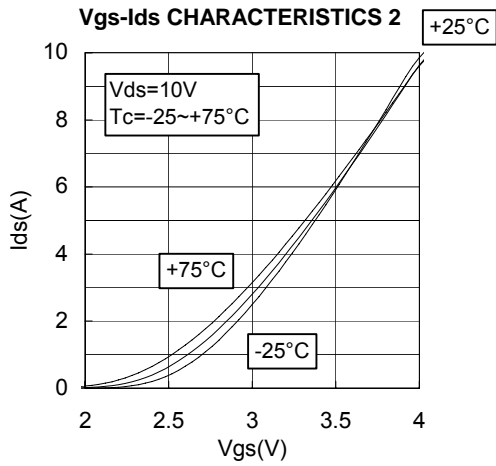

TEST CIRCUIT(f=175MHz)

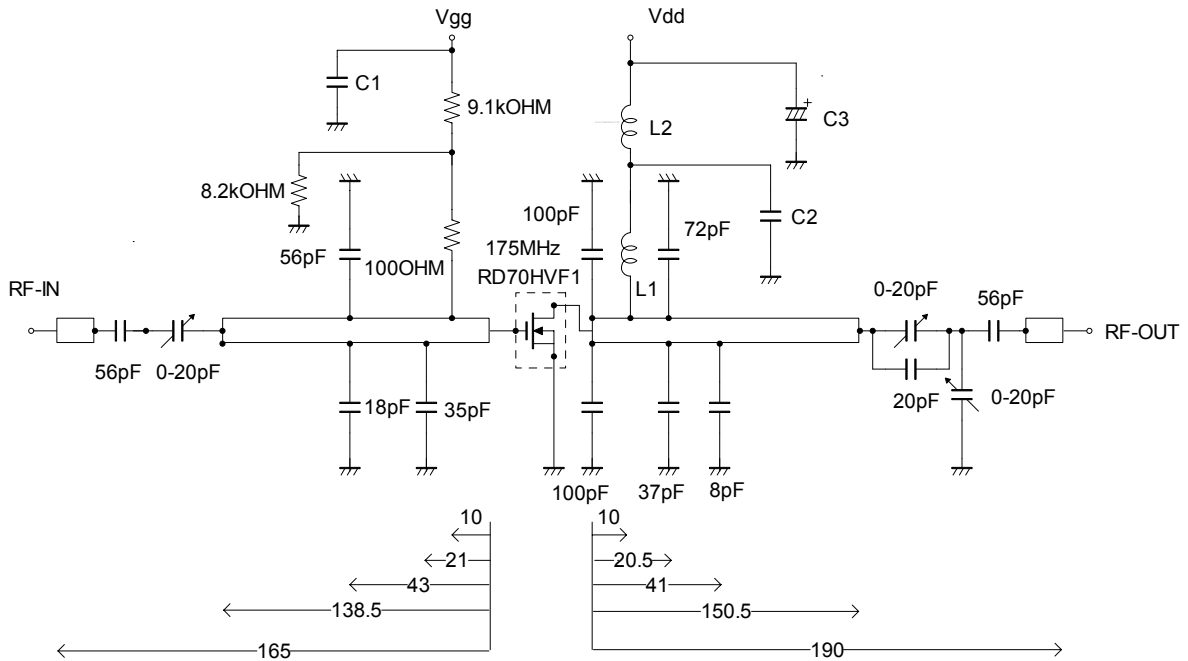

- C1:2200pF 10uF in parallel
- C2:2200pF*2 in parallel
- C3:2200pF,330uF in parallel

- L1:5Turns,l.D6mm,D1.6mm P=1 silver plated copper wire
- L2:4Turns,l.D6mm,D1.6mm P=2 silver plated copper wire

Note:Board material-Teflon substrate
micro strip line width=4.2mm/50OHM,er:2.7,t=1.6mm

Dimensions:mm



ELECTROSTATIC SENSITIVE DEVICE
OBSERVE HANDLING PRECAUTIONS

MITSUBISHI RF POWER MOS FET

RD70HVF1

RoHS Compliance, Silicon MOSFET Power Transistor, 175MHz70W 520MHz,50W

TEST CIRCUIT(f=520MHz)

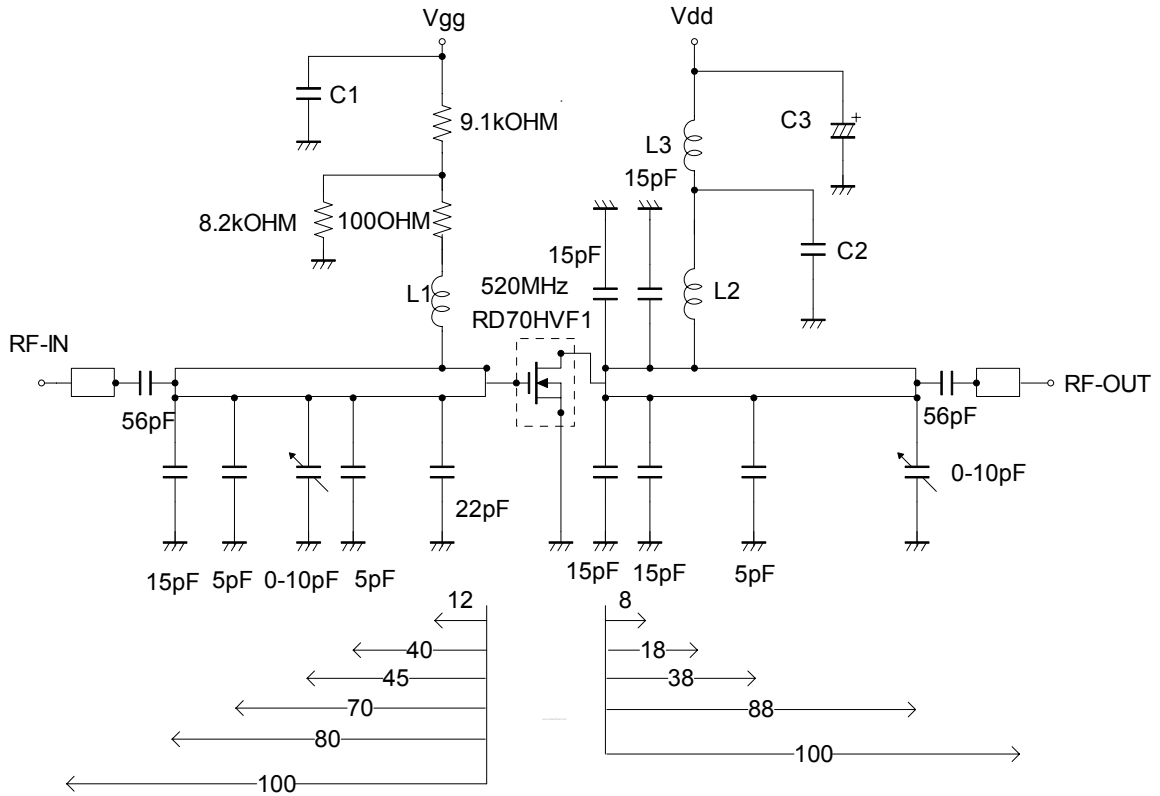

C1:2200pF 10uF in parallel

C2:2200pF*2 in parallel

C3:2200pF,330uF in parallel

L1:4Turns,I.D6mm,D1.6mm P=1 silver plateted copper wire

L2:2Turns,I.D6mm,D1.6mm P=2 silver plateted copper wire

L3:4Turns,I.D6mm,D1.6mm P=1 silver plateted copper wire

Note:Board material-Teflon substrate

micro strip line width=4.2mm/50OHM,er:2.7,t=1.6mm

Dimensions:mm



ELECTROSTATIC SENSITIVE DEVICE
OBSERVE HANDLING PRECAUTIONS

MITSUBISHI RF POWER MOS FET

RD70HVF1

RoHS Compliance, Silicon MOSFET Power Transistor, 175MHz70W 520MHz,50W

INPUT/OUTPUT IMPEDANCE VS.FREQUENCY CHARACTERISTICS

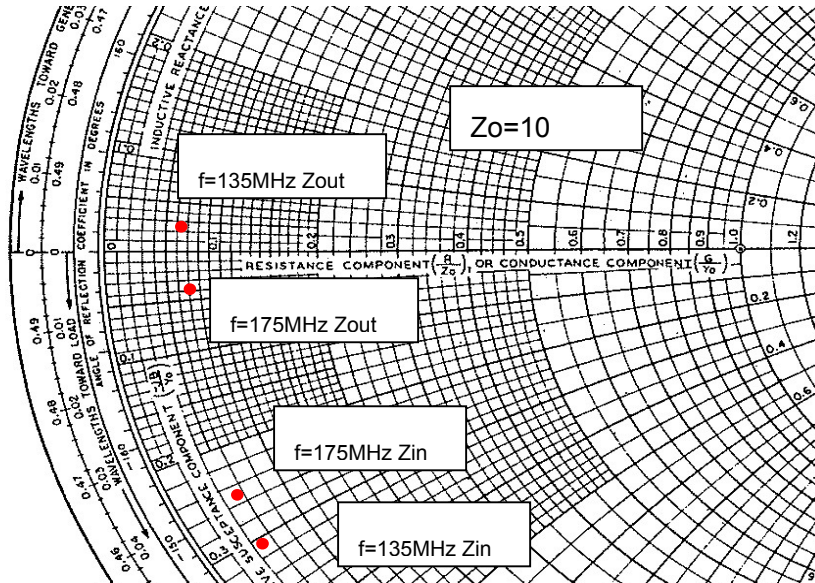

Zin, Zout

f (MHz)	Zin (ohm)	Zout (ohm)	Conditions
135	0.43-j3.19	0.70+j0.25	
175	0.55-j2.53	0.72-j0.36	Po=80W, Vdd=12.5V,Pin=6W

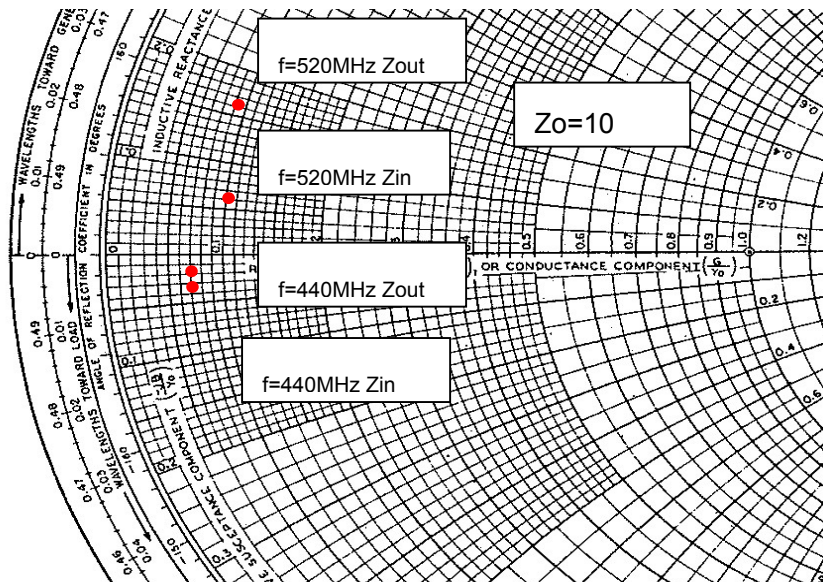

Zin, Zout

f (MHz)	Zin (ohm)	Zout (ohm)	Conditions
440	0.74-j0.34	0.71-j0.18	
520	1.04+j0.63	0.93+j1.62	Po=55W, Vdd=12.5V,Pin=10W



ELECTROSTATIC SENSITIVE DEVICE
OBSERVE HANDLING PRECAUTIONS

MITSUBISHI RF POWER MOS FET

RD70HVF1

RoHS Compliance, Silicon MOSFET Power Transistor, 175MHz70W 520MHz,50W

RD70HVF1 S-PARAMETER DATA (@V_{dd}=12.5V, I_d=500mA)

Freq. [MHz]	S11		S21		S12		S22	
	(mag)	(ang)	(mag)	(ang)	(mag)	(ang)	(mag)	(ang)
50	0.885	-174.0	8.441	72.4	0.013	-16.2	0.745	-170.3
100	0.906	-176.8	3.713	55.3	0.011	-30.9	0.805	-170.5
150	0.930	-179.0	2.095	41.2	0.008	-39.5	0.860	-173.3
175	0.939	179.8	1.647	35.9	0.007	-44.3	0.874	-174.6
200	0.946	178.7	1.337	32.3	0.006	-46.6	0.897	-175.6
250	0.957	176.7	0.908	24.8	0.004	-46.5	0.933	-178.1
300	0.967	174.7	0.661	19.4	0.002	-40.8	0.935	179.4
350	0.969	173.0	0.495	13.6	0.001	-23.4	0.952	177.2
400	0.976	171.0	0.378	12.2	0.002	38.2	0.965	175.0
450	0.974	169.6	0.316	5.4	0.003	73.6	0.965	172.9
500	0.980	168.0	0.276	2.3	0.003	75.6	0.973	171.4
520	0.978	167.2	0.247	0.9	0.003	75.3	0.974	170.6
550	0.980	166.2	0.216	-0.2	0.004	69.2	0.975	169.5
600	0.980	164.6	0.176	-1.5	0.005	74.3	0.974	167.8
650	0.982	163.3	0.156	-1.4	0.007	79.3	0.979	166.3
700	0.985	162.0	0.126	-3.3	0.007	75.4	0.983	164.9
750	0.982	160.7	0.108	-2.0	0.007	76.7	0.982	163.6
800	0.982	159.4	0.106	-1.1	0.009	77.1	0.984	162.0
850	0.984	158.1	0.107	-9.0	0.009	72.6	0.989	160.9
900	0.983	157.0	0.078	-13.4	0.010	72.1	0.983	159.6
950	0.984	155.9	0.079	-4.5	0.011	74.4	0.987	158.2
1000	0.985	154.6	0.067	-5.3	0.011	72.7	0.993	157.3

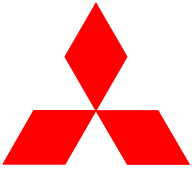

ELECTROSTATIC SENSITIVE DEVICE
OBSERVE HANDLING PRECAUTIONS

MITSUBISHI RF POWER MOS FET

RD70HVF1

RoHS Compliance, Silicon MOSFET Power Transistor, 175MHz70W 520MHz,50W

Keep safety first in your circuit designs!

Mitsubishi Electric Corporation puts the maximum effort into making semiconductor products better and more reliable, but there is always the possibility that trouble may occur with them. Trouble with semiconductors may lead to personal injury, fire or property damage. Remember to give due consideration to safety when making your circuit designs, with appropriate measures such as (i) placement of substitutive, auxiliary circuits, (ii) use of non-flammable material or (iii) prevention against any malfunction or mishap.