

Typical Applications

- Local Oscillator Buffer Amplifiers
- FDD and TDD Communication Systems
- Commercial and Consumer Systems
- Portable Battery-Powered Equipment
- Wireless LAN
- ISM Band Applications

Product Description

The RF2301 is a high reverse isolation buffer amplifier. The device is manufactured on a low-cost Gallium Arsenide MESFET process, and has been designed for use as a general purpose buffer in high-end communication systems operating at frequencies from less than 300MHz to higher than 2500MHz. With +5dBm output power, it may also be used as a driver in transmitter applications. The device is packaged in an 8-lead plastic package. The product is self-contained, requiring just a resistor and blocking capacitors to operate. The output power, combined with 50dB reverse isolation at 900MHz allows excellent buffering of LO sources to impedance changes. The device can be used in 3V battery applications. The unit has a total gain of 17dB with only 14mA current from a 3V supply.

Optimum Technology Matching® Applied

- | | | |
|-------------------------------------|-----------------------------------|---|
| <input type="checkbox"/> Si BJT | <input type="checkbox"/> GaAs HBT | <input checked="" type="checkbox"/> GaAs MESFET |
| <input type="checkbox"/> Si Bi-CMOS | <input type="checkbox"/> SiGe HBT | <input type="checkbox"/> Si CMOS |

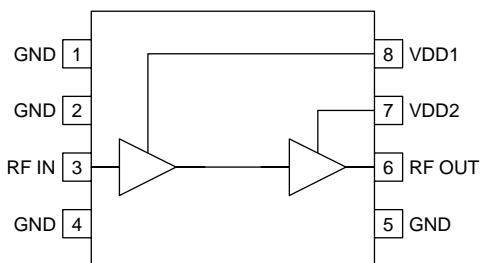

Functional Block Diagram

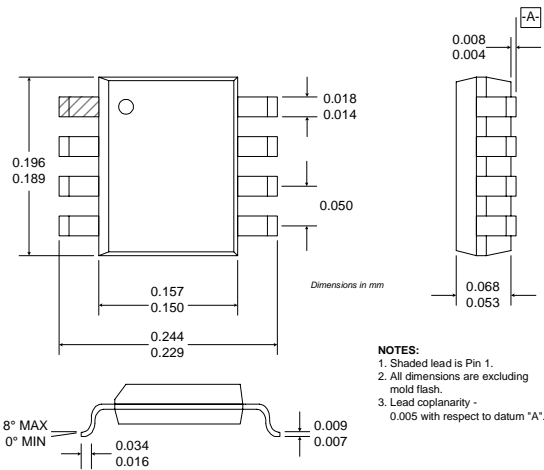

NOTES:
 1. Shaded lead is Pin 1.
 2. All dimensions are excluding mold flash.
 3. Lead coplanarity - 0.005 with respect to datum "A".

Package Style: SOIC-8

Features

- Single 2.7V to 6.0V Supply
- +4dBm Output Power
- 21 dB Small Signal Gain
- 50dB Reverse Isolation at 900MHz
- Low DC Current Consumption of 14mA
- 300MHz to 2500MHz Operation

Ordering Information

- | | |
|-------------|----------------------------------|
| RF2301 | High Isolation Buffer Amplifier |
| RF2301 PCBA | Fully Assembled Evaluation Board |

RF Micro Devices, Inc.
 7628 Thorndike Road
 Greensboro, NC 27409, USA

Tel (336) 664 1233
 Fax (336) 664 0454
<http://www.rfmd.com>

RF2301

Absolute Maximum Ratings

Parameter	Rating	Unit
Supply Voltage (V_{DD})	-0.5 to +6.5	V_{DC}
DC Supply Current	60	mA
Input RF Power	+10	dBm
Operating Ambient Temperature	-40 to +85	$^{\circ}C$
Storage Temperature	-40 to +150	$^{\circ}C$



Caution! ESD sensitive device.

RF Micro Devices believes the furnished information is correct and accurate at the time of this printing. However, RF Micro Devices reserves the right to make changes to its products without notice. RF Micro Devices does not assume responsibility for the use of the described product(s).

Parameter	Specification			Unit	Condition
	Min.	Typ.	Max.		
Overall					$T=25^{\circ}C$, $V_{DD}=5V_{DC}$
Nominal Frequency Range		300 to 2500		MHz	
Input IP_3		-8		dBm	
Noise Figure			8	dB	
Input VSWR		<2:1			In a 50Ω system
Output VSWR		<2:1			In a 50Ω system
Power Supply Voltage		2.7 to 6.0		V	
Nominal 5V Configuration					Using Broad Band Application Circuit, $V_{DD}=5V_{DC}$, Freq=2500MHZ, $T=25^{\circ}C$
Gain	21	24	26	dB	
P_{1dB} Output Power		+4		dBm	
Supply Current	10	30	40	mA	
Reverse Isolation		50		dB	900MHz, without RF input
		50		dB	900MHz, with RF input, saturated
		40		dB	2500MHz, without RF input
		40		dB	2500MHz, with RF input, saturated
Nominal 3V Configuration					Using Broad Band Application Circuit, $V_{DD}=3V_{DC}$, Freq=2500MHZ, $T=25^{\circ}C$
Gain	15	17		dB	
P_{1dB} Output Power		0		dBm	
Supply Current		14		mA	
Reverse Isolation		50		dB	900MHz, without RF input
		50		dB	900MHz, with RF input, saturated
		40		dB	2500MHz, without RF input
		40		dB	2500MHz, with RF input, saturated

RF2301

Pin	Function	Description	Interface Schematic
1	GND	Low inductance ground connections. Use individual vias to backside ground plane, placed within 0.030" of pin landing for optimum performance.	
2	GND	Same as pin 1.	
3	RF IN	DC-coupled RF input. A broadband impedance match is produced by internal shunt resistive feedback. The DC level is 0V. If a DC voltage is present from connected circuitry, an external DC-blocking capacitor is required for the proper DC operating point.	
4	GND	Same as pin 1.	
5	GND	Same as pin 1.	
6	RF OUT	Open drain RF output. A broadband impedance match is produced by an external 100Ω resistor to power supply as shown in Application Schematic 1. Approximately 3dB improvement in gain and output power can be obtained over at least a 20% bandwidth by replacing the resistor to power supply with an external chip inductor network as shown in Application Schematic 2. An external DC-blocking capacitor is required if the following circuitry is not DC-blocked.	
7	VDD2	Power supply connections. Bypass with external chip capacitor and individual via to backside ground plane.	
8	VDD1	Power supply connections. Bypass with external chip capacitor and individual via to backside ground plane.	

4
GENERAL PURPOSE
AMPLIFIERS

Application Schematic 1 Broadband Match

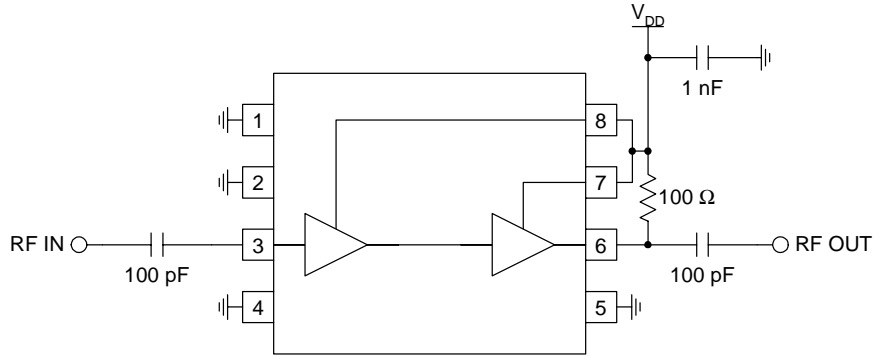

Application Schematic 2 Optimum Match

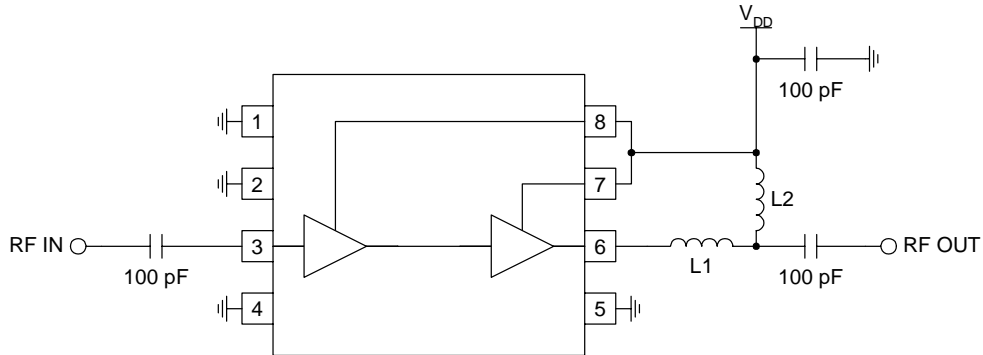

FREQUENCY	L1	L2
900 MHz	18 nH	22 nH
2500 MHz	----	2.7 nH

Evaluation Board Schematic (Download [Bill of Materials](http://www.rfmd.com) from www.rfmd.com.)

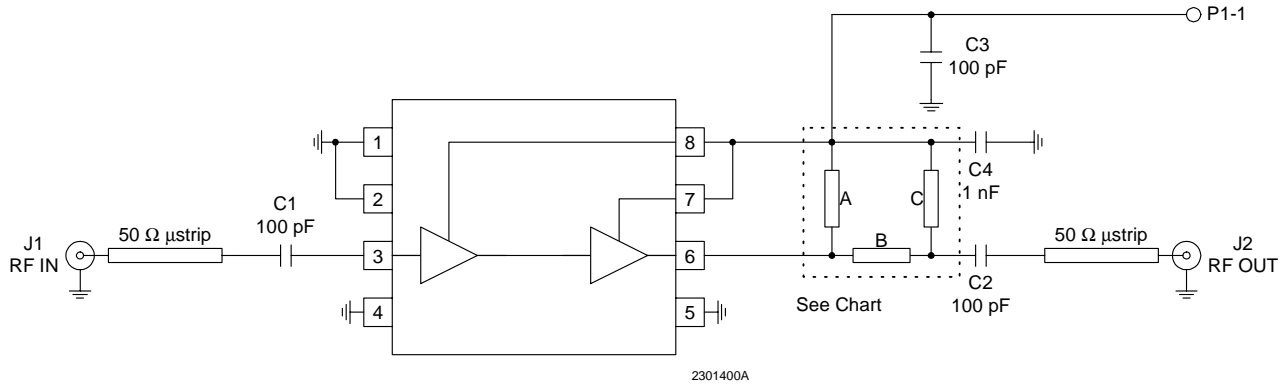

FREQUENCY BAND	COMPONENT		
	A	B	C
BROADBAND (default config.)	100 Ω	0 Ω	N/A
900 MHz	N/A	18 nH	22 nH
2450 MHz	2.7 nH	0 Ω	N/A

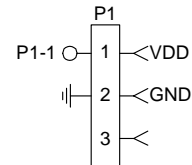

4
GENERAL PURPOSE
AMPLIFIERS

Evaluation Board Layout 1.43" x 1.43" Board Thickness 0.031"; Board Material FR-4

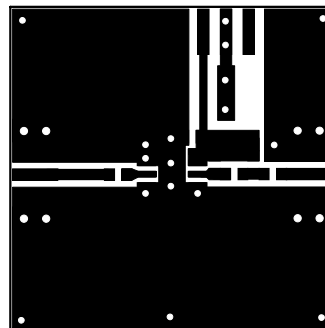
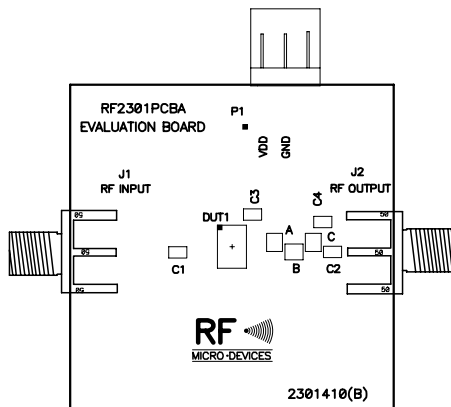

Typical Characteristics Broadband Application Circuit

4

GENERAL PURPOSE
AMPLIFIERS

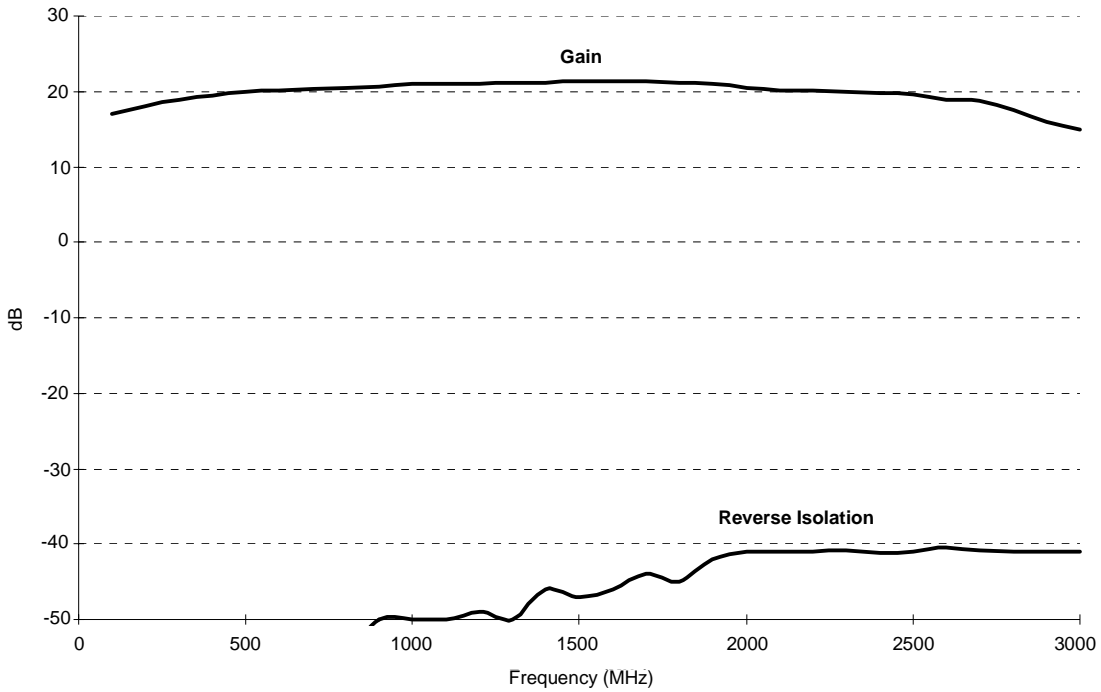
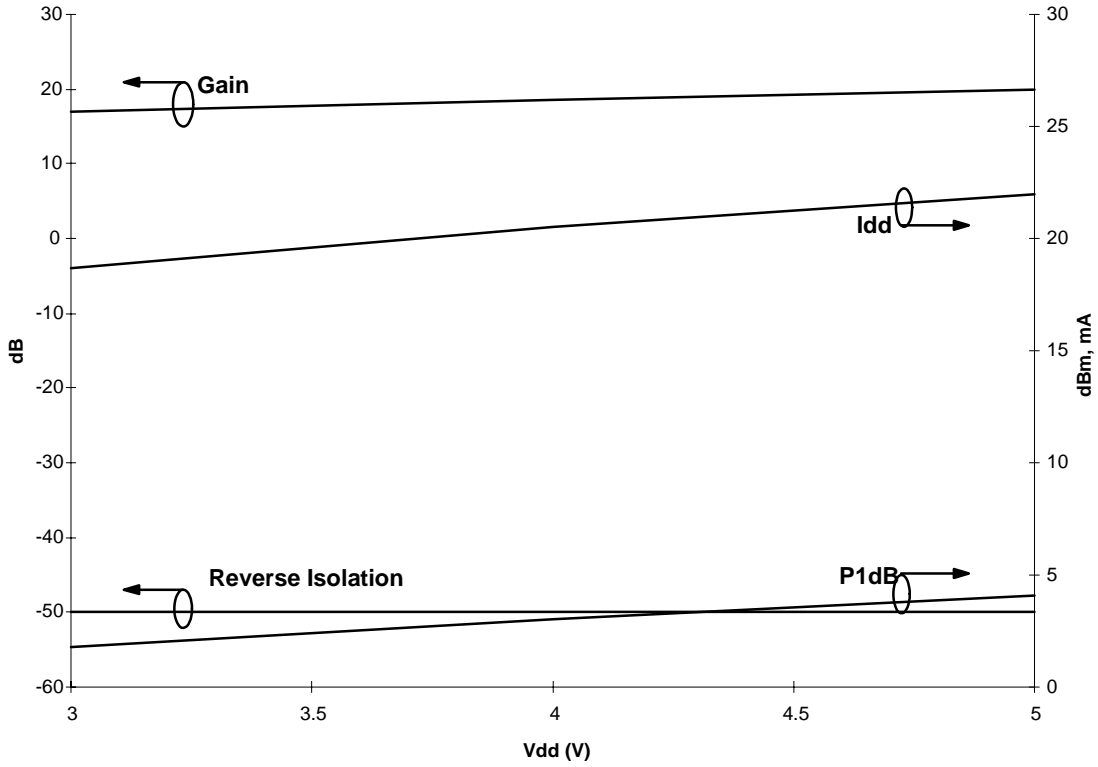

S11, V_{CC} = 3V

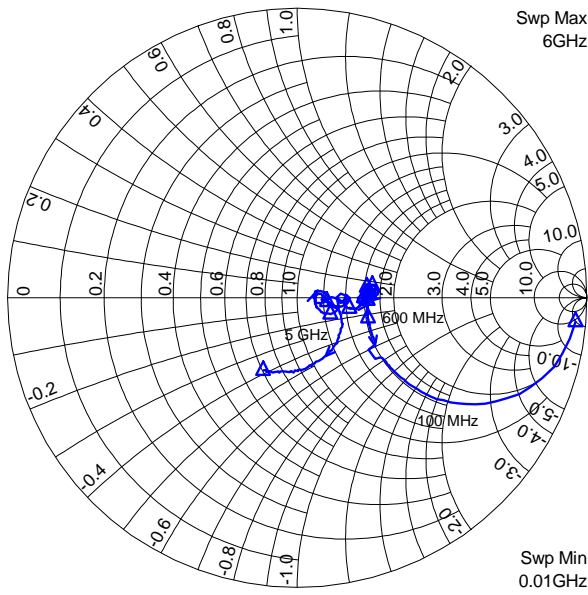

S22, V_{CC} = 3V

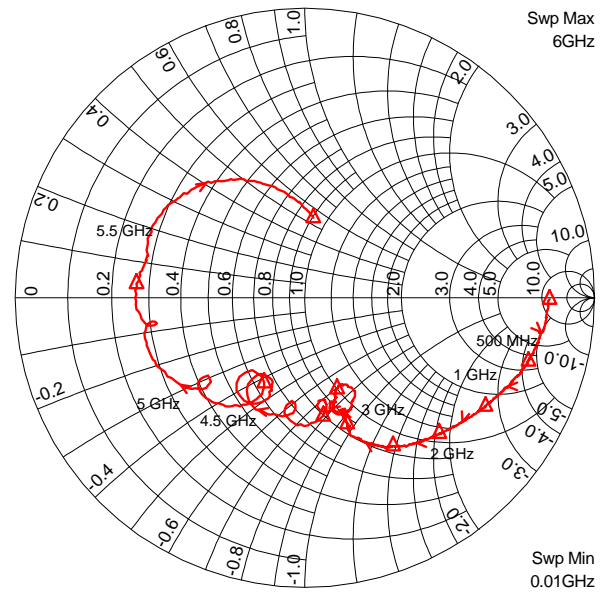

S11, V_{CC} = 5V

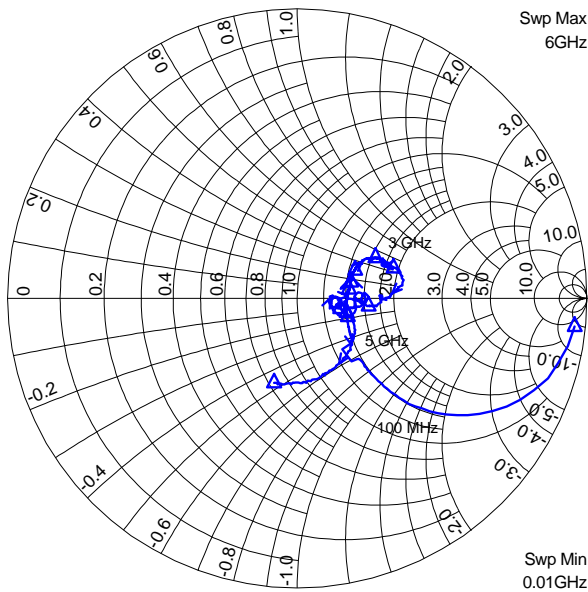

S22, V_{CC} = 5V

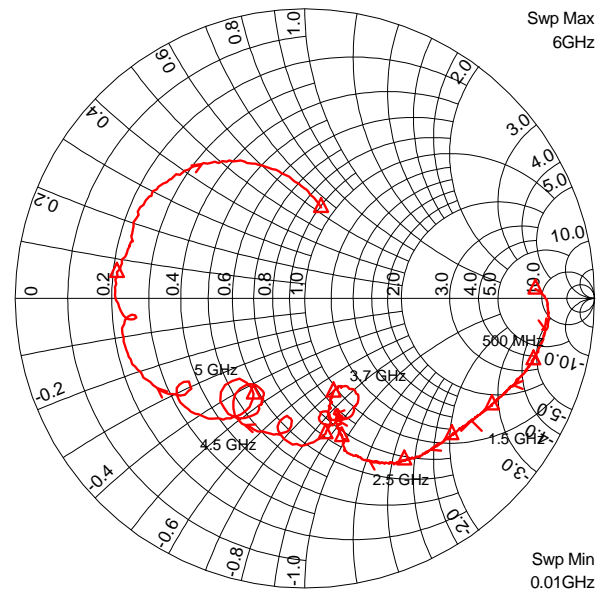

S-Parameter Conditions:
All plots are taken at ambient temperature=25°C.

NOTE:
All S11 and S22 plots shown were taken from an RF2301 evaluation board with external input and output tuning components removed and the reference points at the RF IN and RF OUT pins.

Gain versus Temperature
Freq = 900 MHz

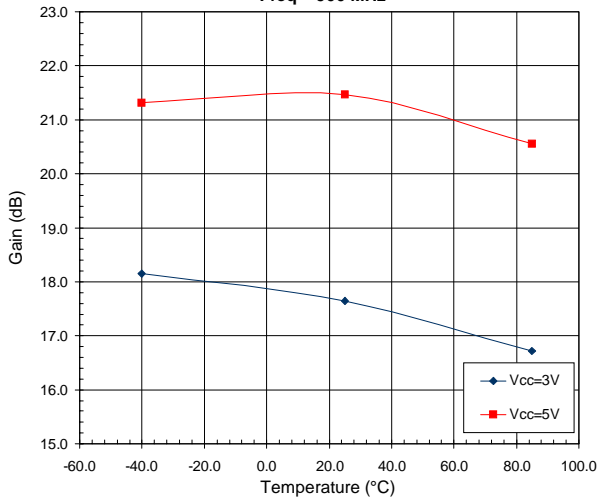

IIP3 versus Temperature
Freq = 900 MHz

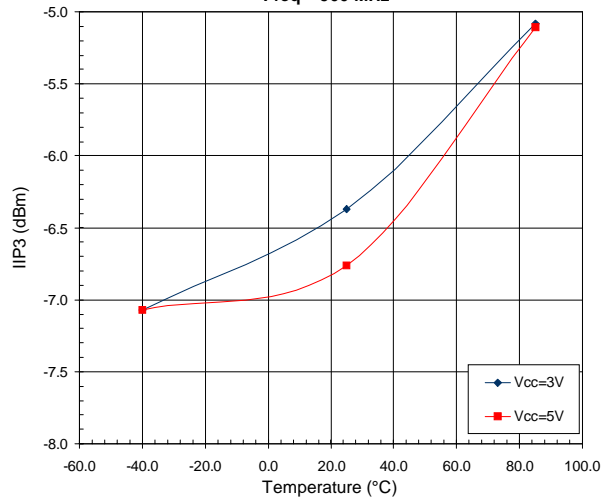

OP1dB versus Temperature
Freq = 900 MHz

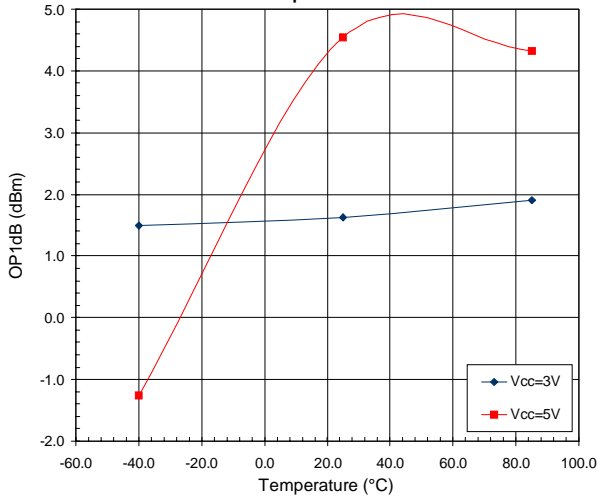

I_{cc} versus Temperature
Freq = 900 MHz

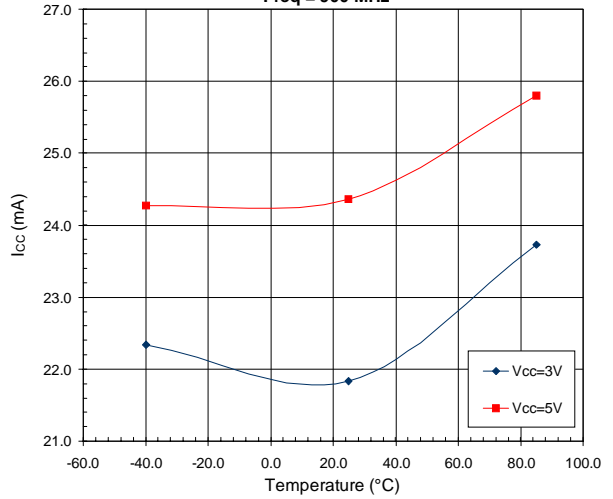

Gain versus Temperature
Freq = 1950 MHz

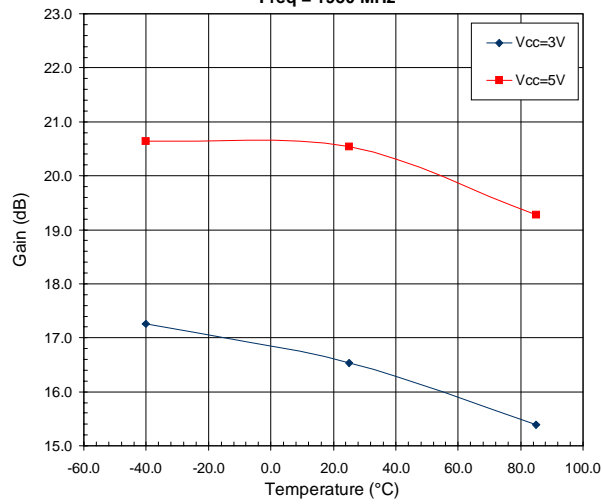

IIP3 versus Temperature
Freq = 1950 MHz

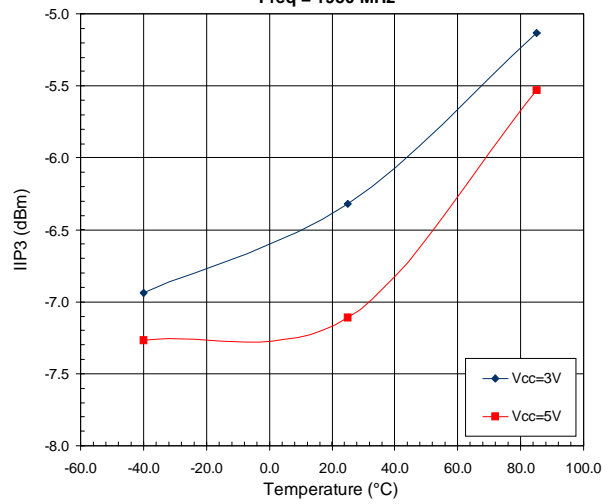

OP1dB versus Temperature
Freq = 1950 MHz

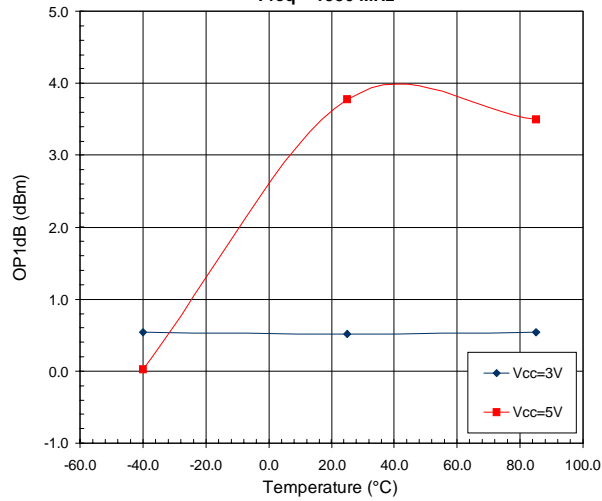

I_{CC} versus Temperature
Freq = 1950 MHz

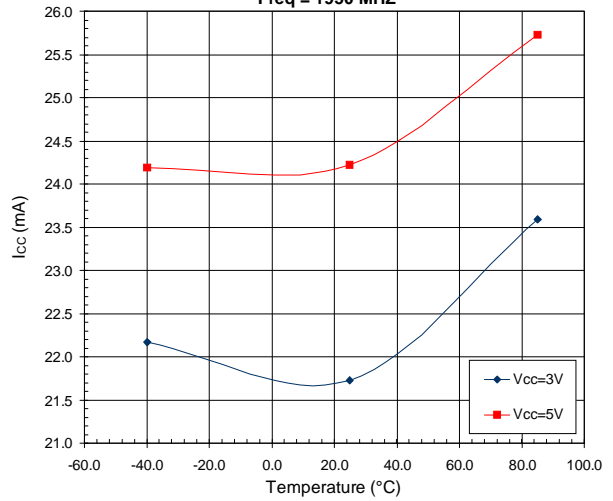

Gain versus Temperature
Freq = 2450 MHz

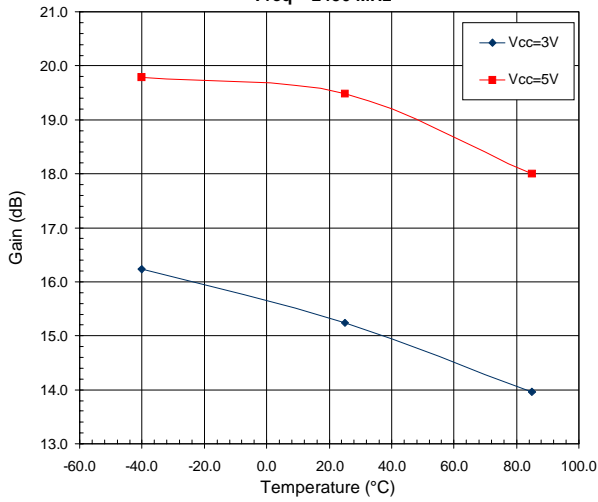

IIP3 versus Temperature
Freq = 2450 MHz

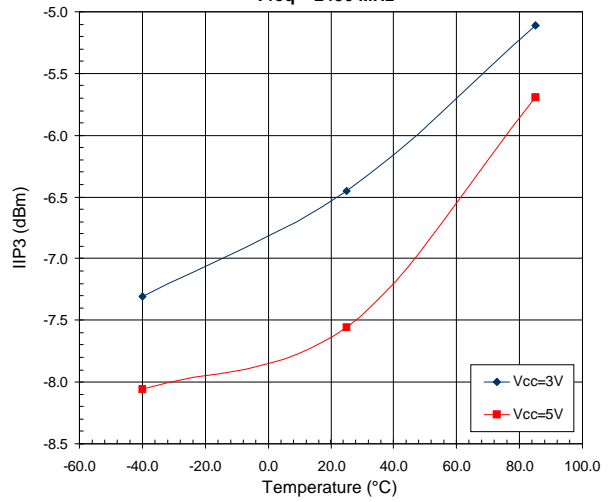

OP1dB versus Temperature
Freq = 2450 MHz

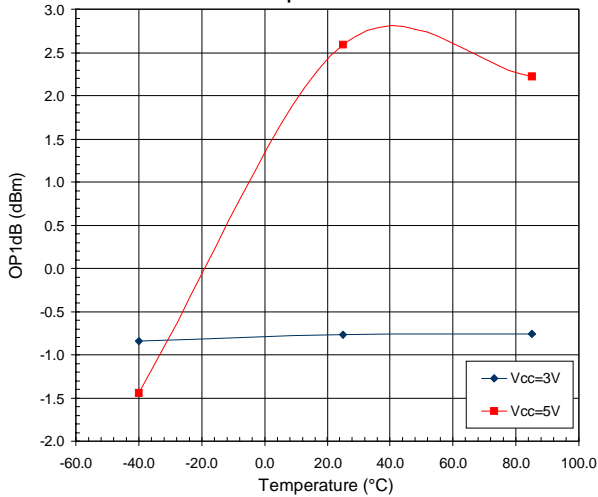

Icc versus Temperature
Freq = 2450 MHz

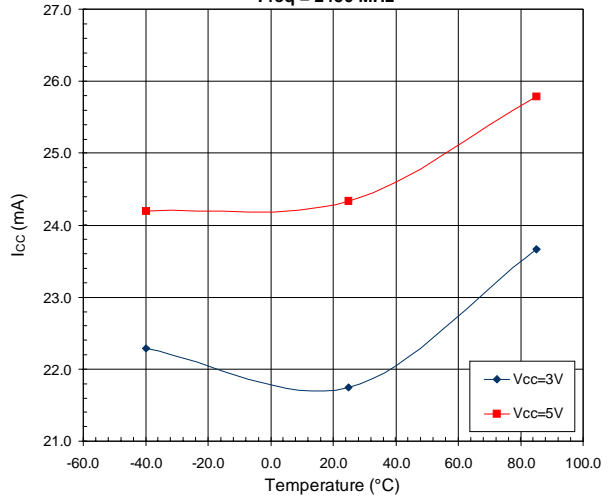

S11 of Evaluation Board versus Frequency
Temperature = +25°C

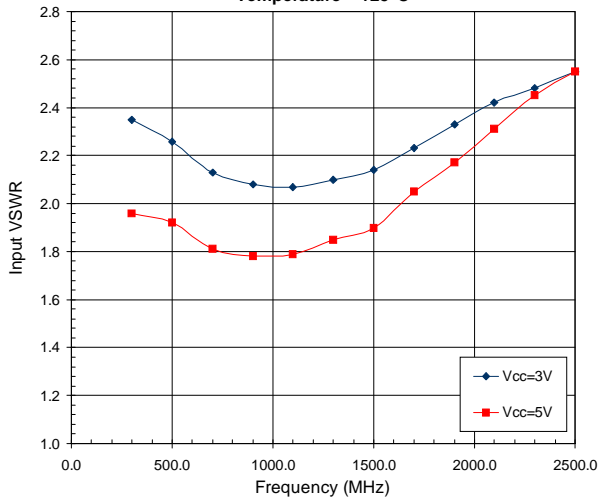

S22 of Evaluation Board versus Frequency
Temperature = +25°C

