

Typical Applications

- CDMA Cellular/PCS and JCDMA Systems
- TDMA Cellular/PCS Systems
- GSM Systems
- Wireless Local Loop Systems
- Wideband CDMA Systems
- PDC Systems (950MHz and 1450MHz)

Product Description

The RF2302 is a broadband linear variable gain amplifier that was designed specifically for digital communications systems that require linear amplification over a wide gain control range. It is suitable for use in CDMA or TDMA systems in the cellular or PCS band, in DAMPS systems, and in PDC systems. Operating supply voltage ranges from 3V to 6V. The device operates over a large frequency band, from 100MHz to 2000MHz, and is tuned to a specific frequency band with an output bias feed inductor and blocking capacitor. Bias optimization may be achieved by adjusting the voltage to pin 8 (PD). The IC is manufactured on an advanced Gallium Arsenide Hetero-junction Bipolar Transistor (GaAs HBT) process and is featured in a new standard miniature 8-lead plastic MSOP package.

Optimum Technology Matching® Applied

- | | | |
|-------------------------------------|--|--------------------------------------|
| <input type="checkbox"/> Si BJT | <input checked="" type="checkbox"/> GaAs HBT | <input type="checkbox"/> GaAs MESFET |
| <input type="checkbox"/> Si Bi-CMOS | <input type="checkbox"/> SiGe HBT | <input type="checkbox"/> Si CMOS |

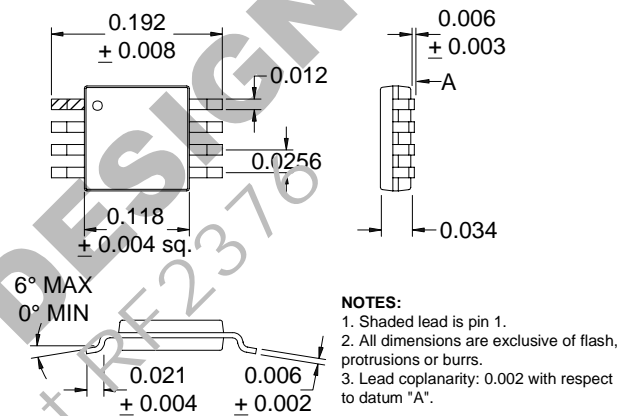

Package Style: MSOP-8

Features

- 25dB Linear Gain Control range
- +14dBm OP1dB at 3.5V (836MHz)
- Single 3V to 6V Supply
- 14dB Max Gain at 836MHz
- 10dB Max Gain at 1900MHz
- 4dB Noise Figure at 836MHz

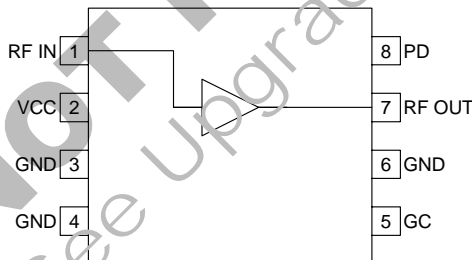

Functional Block Diagram

Ordering Information

RF2302 Broadband Linear Variable Gain Amplifier
 RF2302 PCBA-L Fully Assembled Evaluation Board 836MHz
 RF2302 PCBA-H Fully Assembled Evaluation Board 1.88GHz

RF Micro Devices, Inc.
 7625 Thorndike Road
 Greensboro, NC 27409, USA

Tel (336) 664 1233
 Fax (336) 664 0454
<http://www.rfmd.com>

RF2302

Absolute Maximum Ratings

Parameter	Rating	Unit
Supply Voltage	0 to +8.0	V _{DC}
Power Down Voltage	0 to +3.1	V _{DC}
Gain Control Voltage	0 to +3.1	V _{DC}
DC Current	100	mA
Output Load VSWR	12:1	
Operating Ambient Temperature	-40 to +85	°C
Storage Temperature	-40 to +150	°C



Caution! ESD sensitive device.

RF Micro Devices believes the furnished information is correct and accurate at the time of this printing. However, RF Micro Devices reserves the right to make changes to its products without notice. RF Micro Devices does not assume responsibility for the use of the described product(s).

4

GENERAL PURPOSE
AMPLIFIERS

Parameter	Specification			Unit	Condition
	Min.	Typ.	Max.		
Overall					V _{CC} =3.0V, V _{PD} =2.8V, V _{GC} =2.2V, T=25°C
RF Frequency Range	100		2000	MHz	
Small Signal Maximum Gain	13	14	15	dB	Freq=836MHz, V _{GC} =2.2V
	9	11	12	dB	Freq=1880MHz, V _{GC} =2.2V
Small Signal Minimum Gain	-22	-20	-19	dB	Freq=836MHz, V _{GC} =1.4V
	-30	-29	-27	dB	Freq=1880MHz, V _{GC} =1.4V
Noise Figure		4		dB	Freq=836MHz, V _{GC} =2.2V
		7		dB	Freq=1880MHz, V _{GC} =2.2V
Linear Gain Control Range	32	34		dB	V _{GC} =1.4V to 2.2V
Gain Control Slope	1		3	V/V	Slope=ΔOutput peak voltage/ΔV _{GC}
Input IP3	+11	+12.5		dBm	Freq=836 MHz, V _{GC} =2.2V
	+10	+11		dBm	Freq=1880 MHz, V _{GC} =2.2V
	-1	+1		dBm	Freq=836MHz, V _{GC} =1.4V
	+1	+3		dBm	Freq=1880MHz, V _{GC} =1.4V
Input VSWR		1.8:1	3:1		In 50Ω system
Output VSWR		2.5:1			In 50Ω system
TDMA					
ACPR	-33	-34		dBc	836MHz, V _{GC} =2.2V
	-34	-35		dBc	1880MHz, V _{GC} =2.2V
ALT1	-63	-68		dBc	836MHz, V _{GC} =2.2V
	-73	-75		dBc	1880MHz, V _{GC} =2.2V
CDMA					
ACPR	-50	-52		dBc	836MHz, V _{GC} =2.2V
	-55	-59		dBc	1880MHz, V _{GC} =2.2V
ALT1	-55	-57		dBc	836MHz, V _{GC} =2.2V
Power Supply					T=25°C
Supply Voltage	3		6	V	
Power Down Voltage High	2.7		2.9	V	
Power Down Voltage Low			1.0		
DC Current Consumption	40	50	55	mA	V _{CC} =3.0V, V _{PD} =2.8V, V _{GC} =1.4V to 2.2V
V _{PD} Current		7	9	mA	V _{PD} =2.8V, V _{GC} =2.2V, V _{CC} =3.0V
V _{GC} Current		16	18	μA	V _{PD} =2.8V, V _{GC} =2.2V, V _{CC} =3.0V
Power Down Current			10	μA	V _{PD} <1V, V _{GC} <1V
Turn On/Off Time			100	nS	

Pin	Function	Description	Interface Schematic
1	RF IN	RF input pin. This pin is DC coupled and requires a blocking capacitor.	
2	VCC	Power supply. This pin is connected to a battery or a regulated supply and requires a bypass capacitor as close to the pin as possible.	
3	GND	Ground connection. Keep traces physically short and connect immediately to ground plane for best performance.	
4	GND	Ground connection. Keep traces physically short and connect immediately to ground plane for best performance. Use a separate ground via for this pin.	
5	GC	Analog gain control pin. This pin controls the gain of the IC. Minimum gain occurs at $V_{GC} < 1V$ and maximum gain is achieved with $V_{GC} = 2.2V$. 25dB of linear gain control with no variation of input P_{1dB} is available, and additional attenuation is possible with $V_{GC} < 1V$ with input P_{1dB} variation. Bypass this pin near the device.	
6	GND	Same as pin 3.	
7	RF OUT	RF output pin. This pin is DC coupled and requires V_{CC} through a bias inductor sized accordingly to provide a high pass transformation with a series capacitor. This LC transformation sets the output load line for the amplifier. If this amplifier is driving a power amplifier or antenna, no additional matching is required. However, to improve the output match, a parallel resistor can be added across the inductor. For 836MHz applications use a 10nH bias inductor (optional resistor $R3=100\text{ ohms}$) and 2.7pF coupling capacitor. For 1900MHz applications use a 2.7nH bias inductor (optional resistor $R3=150\text{ohms}$) and 1.0pF coupling capacitor.	
8	PD	Power down pin. This pin provides bias for the amplifier. To turn the amplifier on, this pin should be at 2.8V. Reducing this voltage below 0.5V ensures that the amplifier will draw less than 10 μ A current from the supply. Additionally, bias current can be optimized for lower output power by adjusting this voltage over a 2.7V to 2.9V range from a regulated supply.	

Evaluation Board Schematic - 836MHz or 1900MHz (Download [Bill of Materials](http://www.rfmd.com) from www.rfmd.com.)

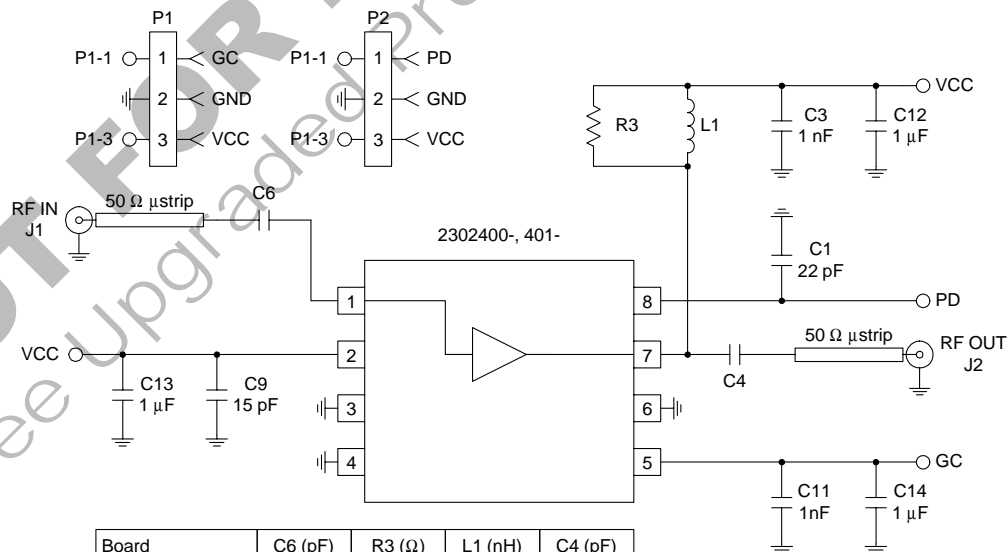

Board	C6 (pF)	R3 (Ω)	L1 (nH)	C4 (pF)
L (836 MHz)	12	100	10	2.7
H (1900 MHz)	3.3	150	2.7	1

Evaluation Board Layout 836MHz Board Size 2.0" x 2.0"

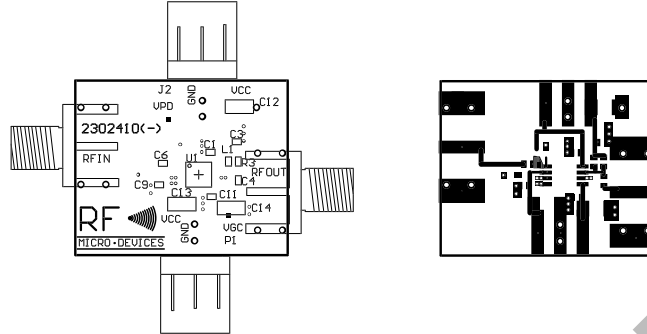

Evaluation Board Layout 1.88GHz

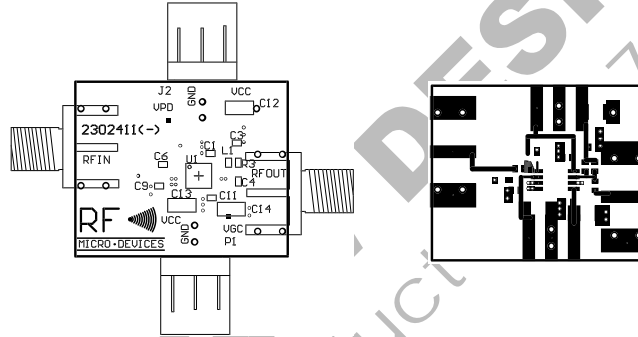

NOT FOR NEW DESIGNS
See Upgraded Product 76

Gain @ 3.3, 3.0, 2.7V versus V_{GC}
 (Frequency 1880MHz @ -8dBm, IS-95 Mod. $V_{PD}=2.8V$,
 $V_{GC}=2.2$ to 1.4V)

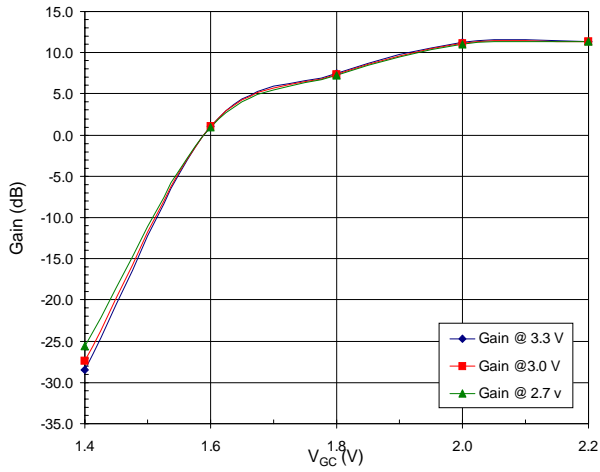

Gain @ 3.3, 3.0, 2.7V versus V_{GC}
 (Frequency 836MHz @ -6dBm, IS-95 Mod., $V_{CC}=3.0V$, $V_{PD}=2.8V$,
 $V_{GC}=2.2$ to 1.4V)

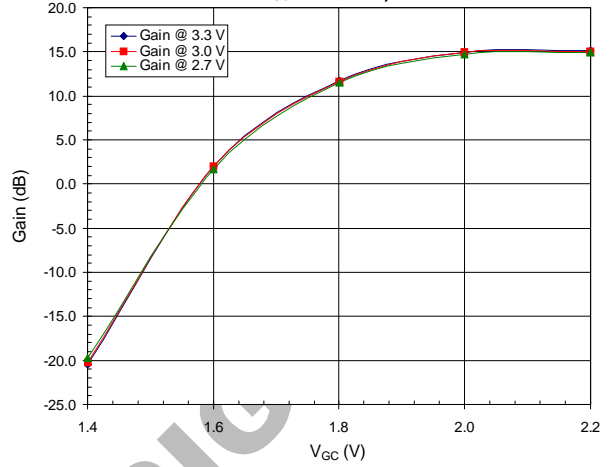

I_{GC} versus V_{GC}
 (Frequency 1880MHz @ -8dBm, $V_{CC}=3.0V$, $V_{PD}=2.8V$)

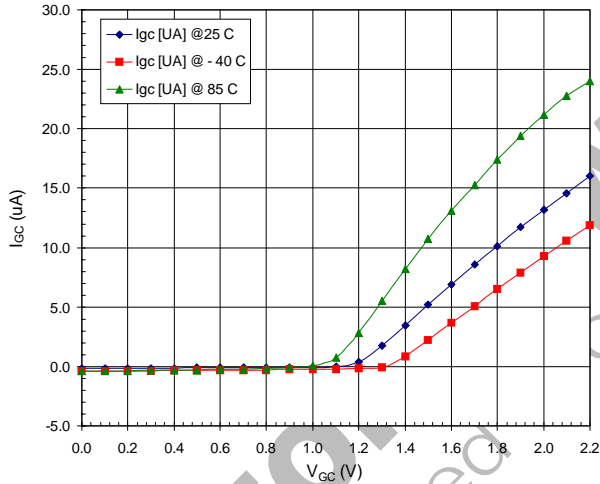

I_{GC} versus V_{GC}
 (Frequency 836MHz @ -6dBm, $V_{CC}=3.0V$, $V_{PD}=2.8V$)

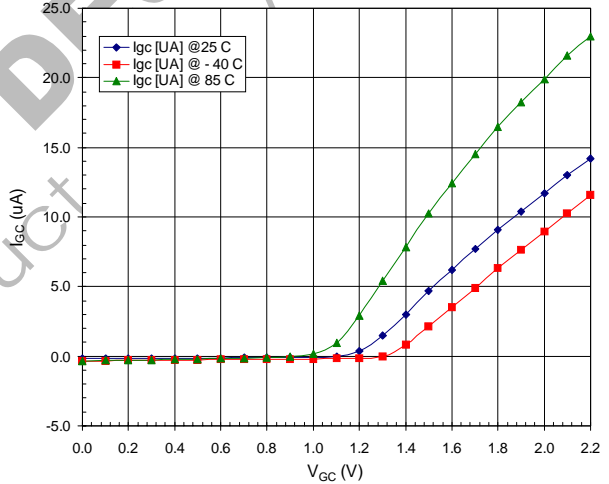

I_{PD} versus V_{PD}
 (Frequency 1880MHz, $V_{CC}=3.0V$, $V_{GC}=2.2V$)

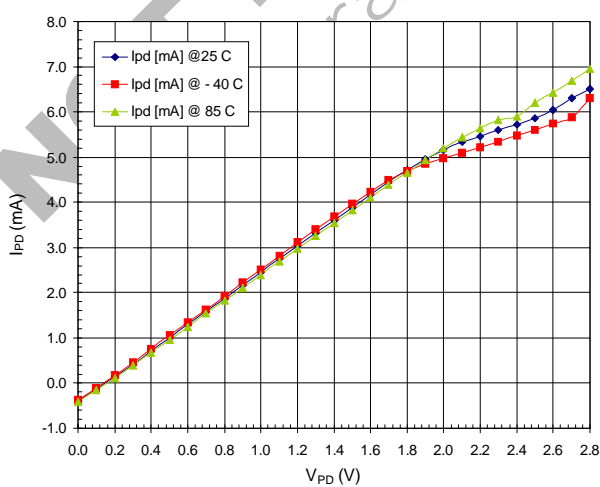

I_{PD} versus V_{PD}
 (Frequency 836MHz @ -6 dBm, $V_{CC}=3.0V$, $V_{GC}=2.2V$)

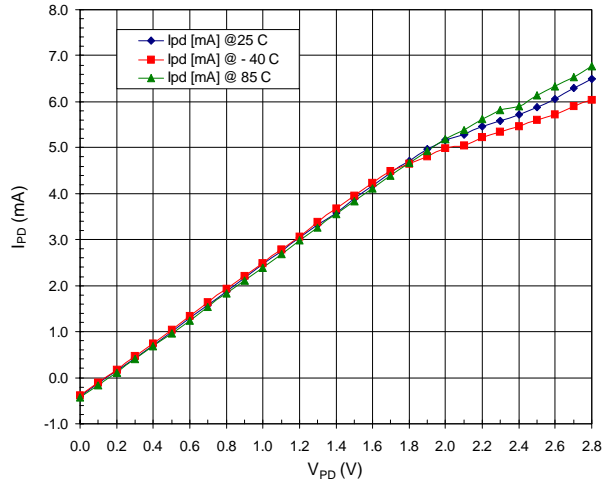

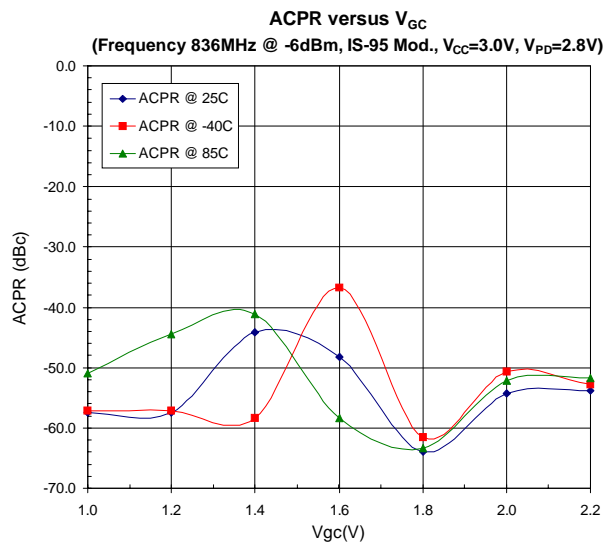
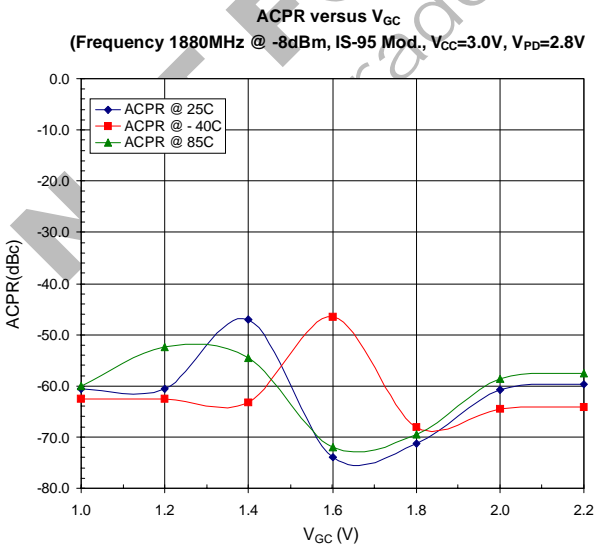
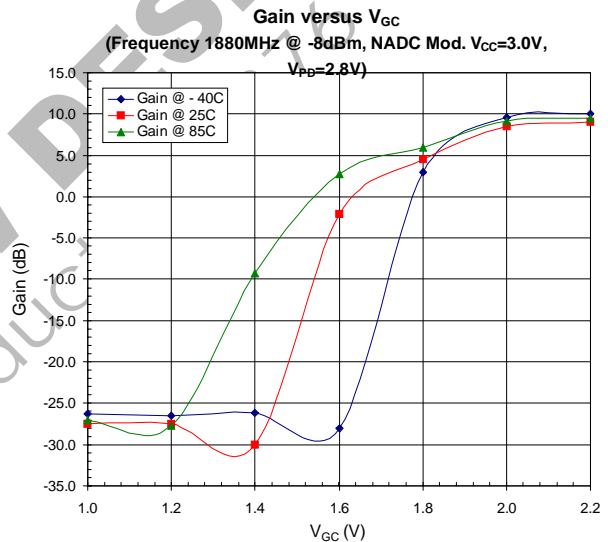
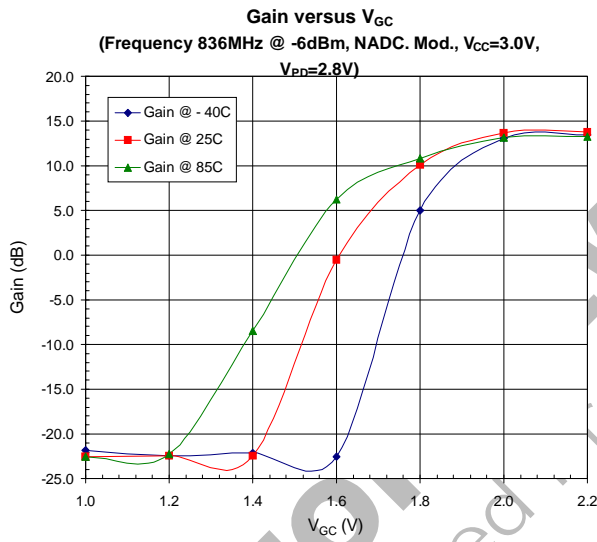
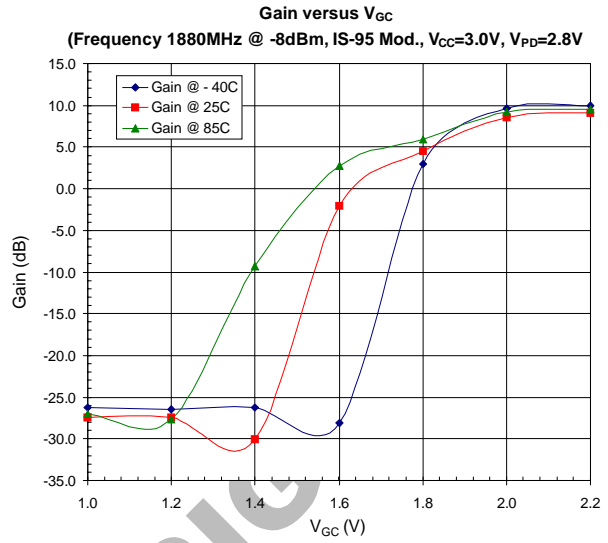
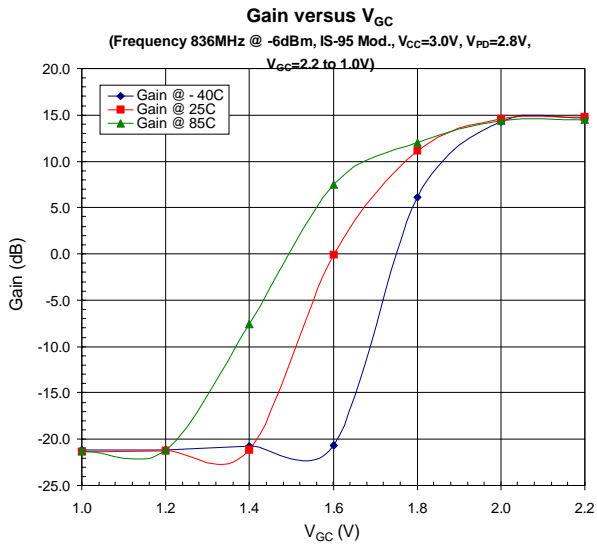

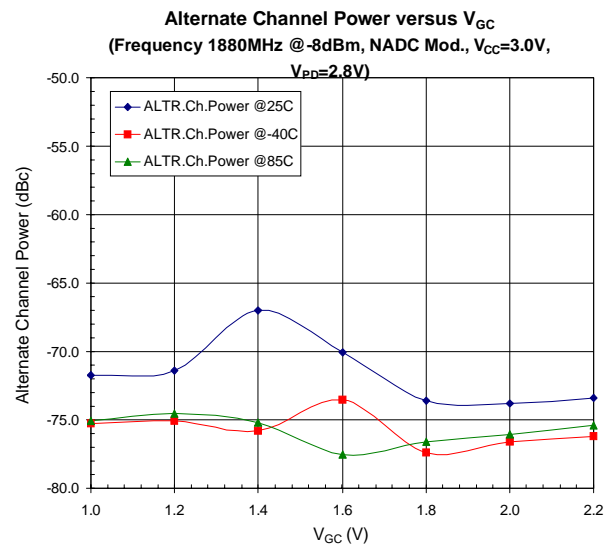
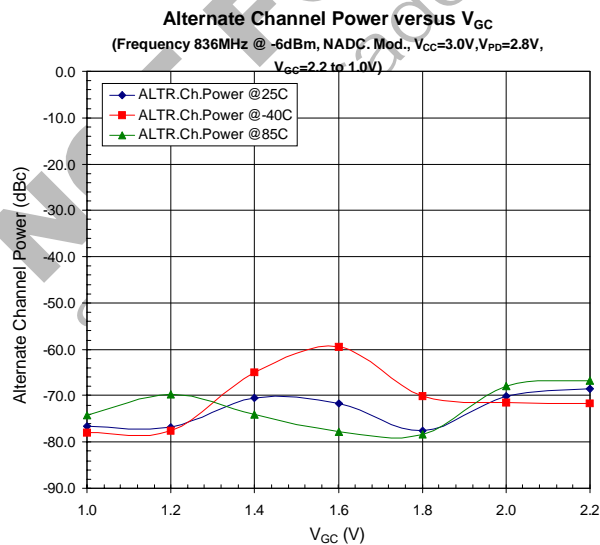
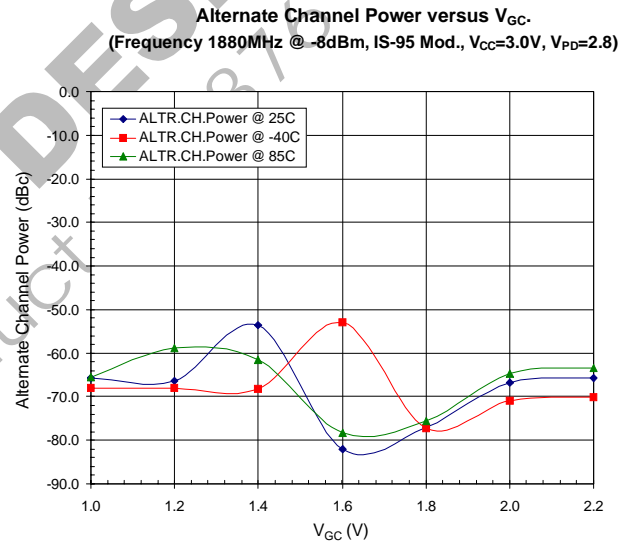
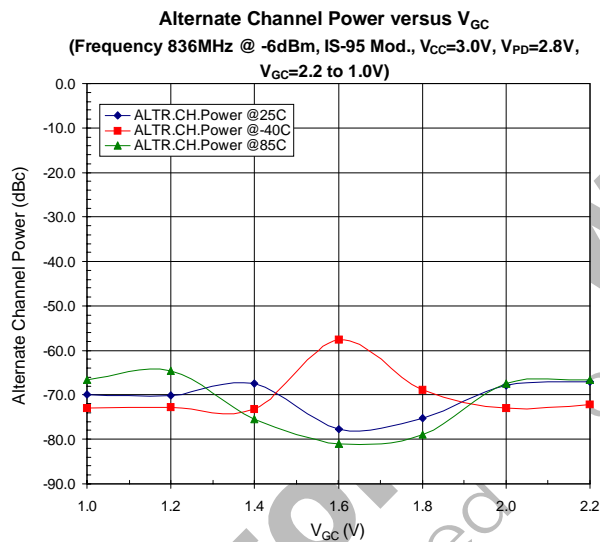
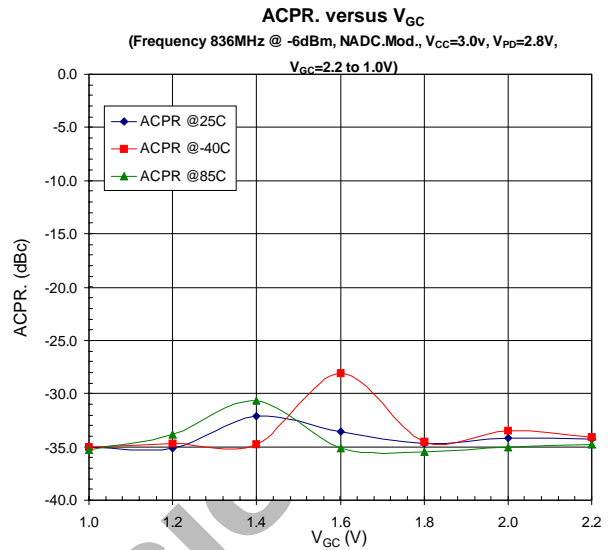
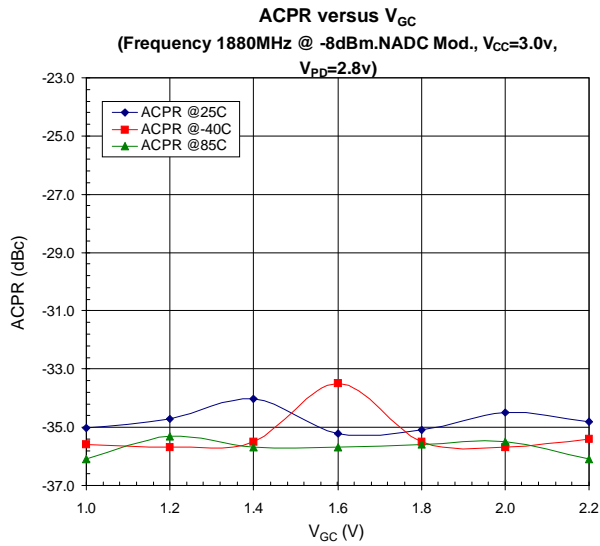

NOT FOR NEW DESIGNS
See Upgraded Product RF2376