

### Typical Applications

- 915MHz ISM Band Products
- Digital Communications
- Quadrature Modulation
- Portable Battery-Powered Equipment

### Product Description

The RF2942 is an integrated power amplifier and quadrature modulator IC. The quadrature modulator is driven with a single-ended local oscillator (LO) source. The quadrature phase generation of the LO is accomplished using an internal passive network tuned for twice the operating frequency. The LO frequency is at twice the RF frequency to avoid interfering with an external synthesizer.

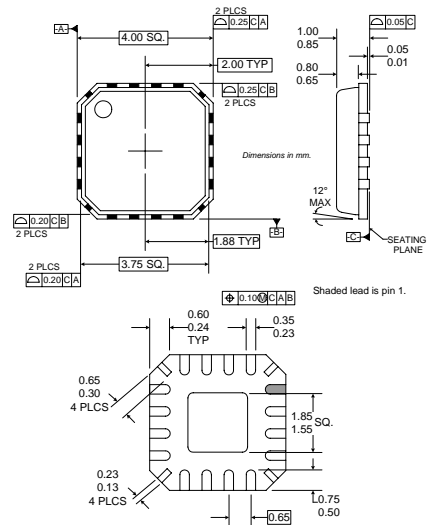

### Optimum Technology Matching® Applied

- |                                     |                                   |  |
|-------------------------------------|-----------------------------------|--|
| <input type="checkbox"/> Si BJT     | <input type="checkbox"/> GaAs HBT | <input type="checkbox"/> GaAs MESFET             |
| <input type="checkbox"/> Si Bi-CMOS | <input type="checkbox"/> SiGe HBT | <input type="checkbox"/> Si CMOS                 |
| <input type="checkbox"/> InGaP/HBT  | <input type="checkbox"/> GaN HEMT | <input checked="" type="checkbox"/> SiGe Bi-CMOS |

### Package Style: QFN, 16-Pin, 4x4

### Features

- 2.0V to 3.6V Power Supply
- 902MHz to 928MHz Frequency Range
- 200mW Output Power
- Low LO Input Level
- Low Broadband Noise Floor
- Small Footprint

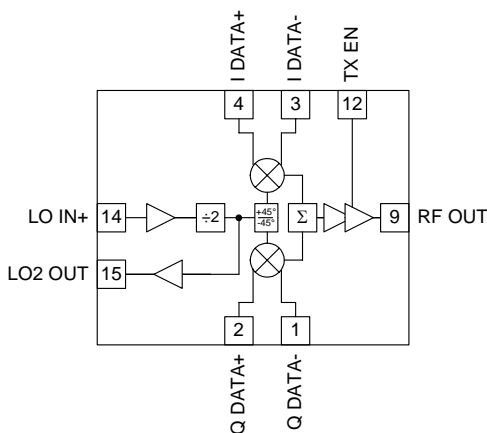

Functional Block Diagram

### Ordering Information

RF2942 UHF Quadrature Modulator and Transmitter  
 RF2942 PCBA Fully Assembled Evaluation Board

RF Micro Devices, Inc.  
 7628 Thorndike Road  
 Greensboro, NC 27409, USA

Tel (336) 664 1233  
 Fax (336) 664 0454  
<http://www.rfmd.com>

# RF2942

## Absolute Maximum Ratings

Parameter	Rating	Unit
Supply Voltage	-0.5 to +3.6	V <sub>DC</sub>
Power Down Voltage (V <sub>PD</sub> )	V <sub>CC</sub> +0.4	V <sub>DC</sub>
Input LO and RF Levels	+6	dBm
Operating Ambient Temperature	-40 to +85	°C
Storage Temperature	-40 to +150	°C



**Caution!** ESD sensitive device.

RF Micro Devices believes the furnished information is correct and accurate at the time of this printing. However, RF Micro Devices reserves the right to make changes to its products without notice. RF Micro Devices does not assume responsibility for the use of the described product(s).

Parameter	Specification			Unit	Condition
	Min.	Typ.	Max.		
<b>Power Supply</b>					
Voltage	2.0	2.8	3.6	V	Specifications Operating limits  TXEN=0.0V T=25 °C, V <sub>CC</sub> =2.8V
Current	170	225	260	mA	
	10		24	mA	
<b>Carrier Input (LO IN)</b>					
Frequency Range		1800 to 1860		MHz	1830MHz
Power Level	-15	-6		dBm	
Input Impedance		50		Ω	
<b>Modulation Input</b>					
Frequency Range	DC	2	10	MHz	50Ω source, I,Q=400mV <sub>p-p</sub> Differential
Modulation for P <sub>OUT</sub> Power (I & Q)		400		mV <sub>p-p</sub>	
Quadrature Phase Error		±2	±5	°	
I/Q Amplitude Imbalance		0.2		dB	
Input Impedance		≥10		kΩ	
<b>RF Output</b>					
Power Output		23		dBm	T=25°C, V <sub>CC</sub> =2.8V, LO power=-6dBm, SSB, I/Q=400mV <sub>p-p</sub> sine wave, 500kHz V <sub>CC</sub> =3.0V V <sub>CC</sub> =2.8V  Modulation DC offset can be externally adjusted for optimum suppression. Carrier suppression is then typically better than 40dB.
Second Harmonic Output	21	22	27	dBm	
Third Harmonic Output	-20	-25		dBc	
Sideband Suppression	-35	-45		dBc	
Carrier Suppression	-25	-40		dBc	
Broadband Noise Floor		-90		dBm/Hz	

Pin	Function	Description	Interface Schematic
1	<b>QSIG-</b>	Reference voltage for the I and Q mixer. This voltage should be the same as the DC voltage supplied to the I and Q SIG pin. To obtain a carrier suppression of better than 40dB it may be tuned $\pm 0.15V$ (relative to the I and Q SIG DC voltage). Without tuning, the carrier suppression will typically be better than 25dB. The input impedance of this pin is typically $>10\text{ k}\Omega$ .	
2	<b>QSIG+</b>	Same as pin 1, except complementary input.	See pin 1.
3	<b>ISIG-</b>	Same as pin 4, except complementary input.	See pin 1.
4	<b>ISIG+</b>	This pin is used to supply $V_{CC}$ to the modulator circuits. A RF bypass capacitor should be connected directly to this and ground. Baseband input to the I mixer. A DC bias of approximately 1.2V is present at this pin. A DC blocking capacitor is needed if the signal has a different DC level. Maximum output power is obtained when the input signal has a peak to peak amplitude of 1V. The input impedance of this pin is about $3\text{ k}\Omega$ . The SIG- and SIG+ inputs are interchangeable. If swapping the I SIG+ and I SIG- pins, the Q SIG+ and Q SIG- also need to be swapped to maintain the correct phase. The SIG+ and SIG- pins may be driven differentially for BPSK to increase conversion gain.	See pin 1.
5	<b>N/C</b>	No connection.	
6	<b>GND</b>		
7	<b>PA VCC</b>	Voltage supply for PA driver.	
8	<b>N/C</b>	No connection.	
9	<b>RF OUT</b>	Power Amp output, open collector output.	
10	<b>N/C</b>	No connection.	
11	<b>VCC3</b>	Voltage supply for PA buffer.	
12	<b>TX EN</b>	TX enabled when $>2.0V$ . When TX EN is held low, only the LO buffer, LO divider and LO divider buffer are left on. To power all of the circuitry down, TX EN and VCC1 must be held low.	
13	<b>VCC1</b>	Voltage supply for LO buffer and divider.	
14	<b>LO IN</b>	The LO input level should be greater than $-15\text{ dBm}$ for proper operation.	
15	<b>LO/2 OUT</b>	LO divide-by-2 output.	
16	<b>VCC2</b>	Voltage supply for mixers.	

# RF2942

## Pin Out

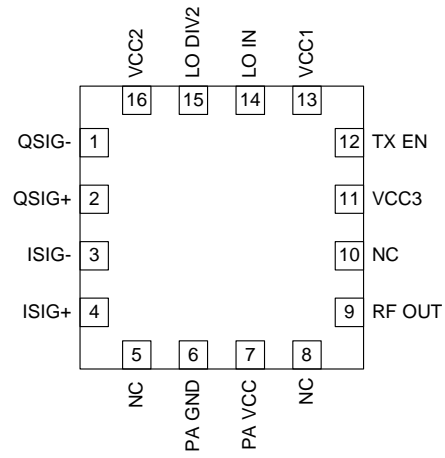

## Theory of Operation

### Modulator

The modulator is a direct conversion double balanced quadrature mixer architecture. The local oscillator signal is buffered then split with internal phase shifters that are optimized for twice the operating frequency. The LO buffer provides isolation from load changes that may occur as the power amplifier section is turned on and off. In addition, the LO buffer may be left on when the transmit section is turned off to prevent load pulling of the external oscillator, by holding TX EN low and leaving the bias on VCC1.

The baseband I and Q pins are connected to the internal mixer bias, therefore it is recommended that the modulation signal be DC-blocked if a similar external reference voltage cannot be provided. The baseband drive may be either single-ended with the complementary input AC-grounded with a capacitor or driven differentially.

### Power Amplifier

The power amplifier requires matching on the output (RF OUT) and the interstage transistor (PA VCC).

# RF2942

## Evaluation Board Schematic - 915MHz

(Download [Bill of Materials](http://www.rfmd.com) from [www.rfmd.com](http://www.rfmd.com)).

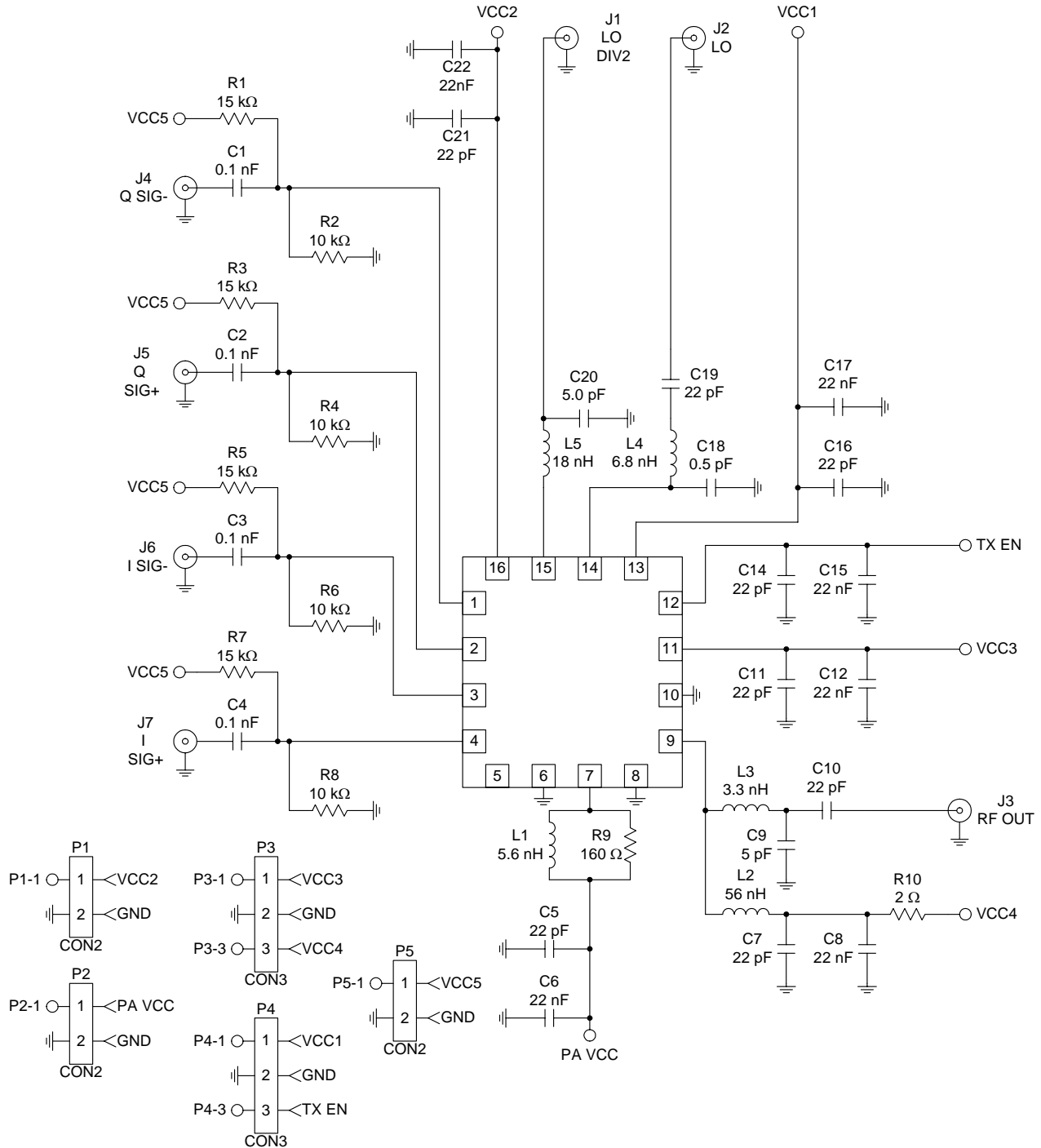

### Evaluation Board Layout Board Size 1.4" x 1.5"

Board Thickness 0.032", Board Material FR-4, Multi-Layer

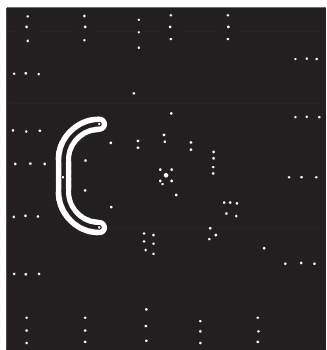
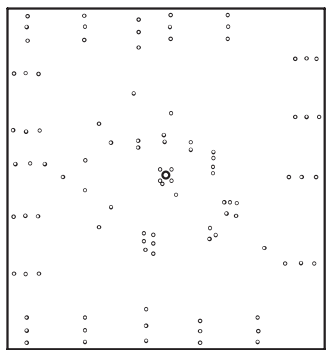
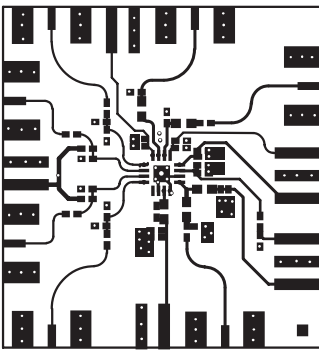
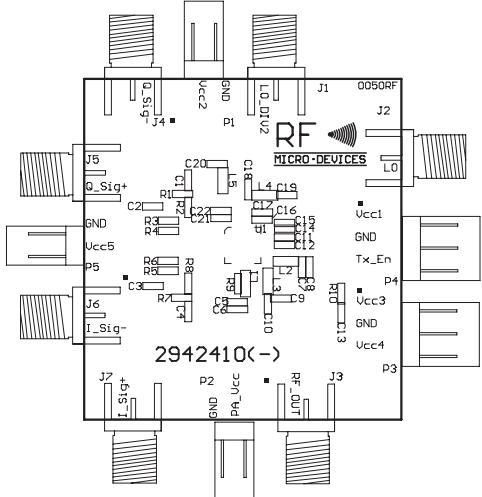

# RF2942

## Graphs

Unless swept, the conditions for the subsequent graphs are as follows. All cable losses accounted for in measurements.

VCC=2.8V                      I/Q Frequency=1MHz  
 LO Frequency=1830MHz      I/Q Amplitude=400mV<sub>P-P</sub>  
 LO Amplitude=-6dBm        I/Q Phase=90°

**P<sub>OUT</sub> versus V<sub>CC</sub> Over Temperature**

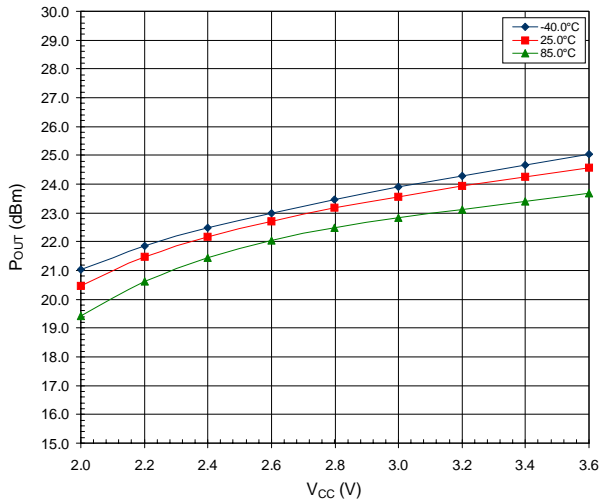

**P<sub>OUT</sub> versus LO Amplitude Over Temperature**

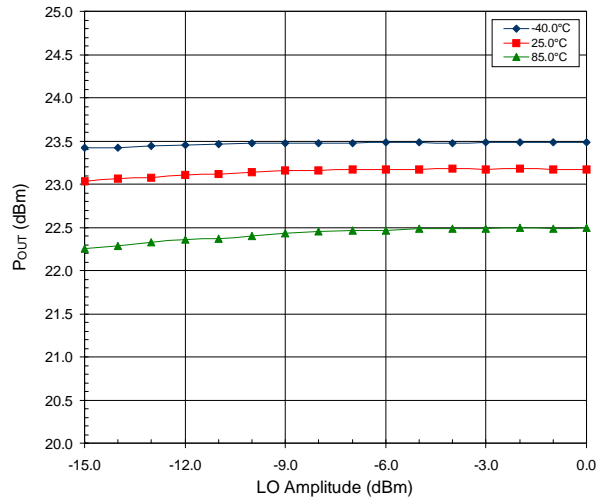

**P<sub>OUT</sub> versus LO Frequency Over Temperature**

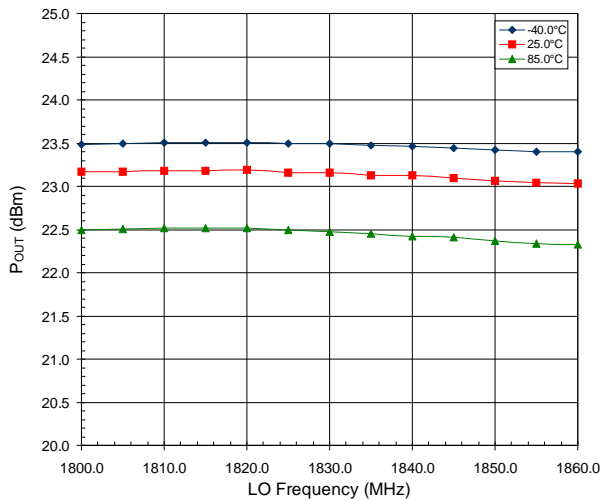

**P<sub>OUT</sub> versus I/Q Amplitude Over Temperature**

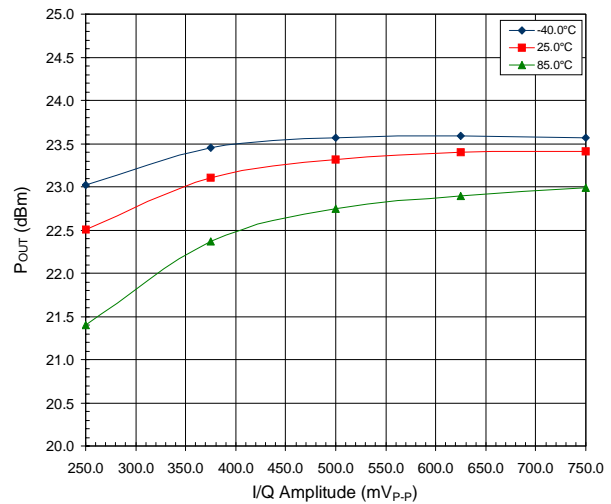



Idle Current versus  $V_{CC}$  Over Temperature

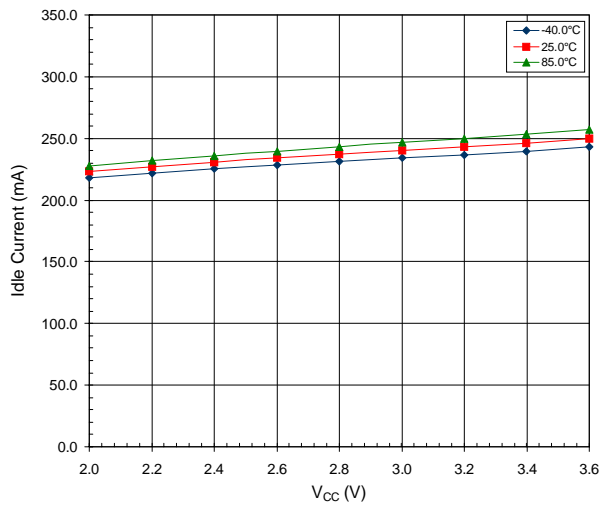

$I_{CC}$  versus  $V_{CC}$  Over Temperature

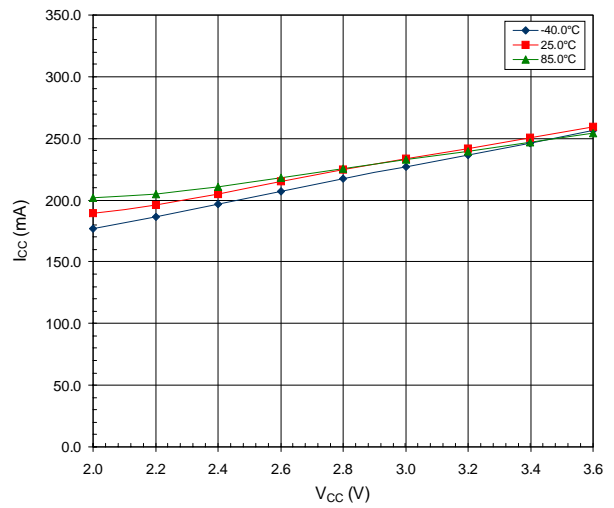

$P_{OUT}$  2f0 versus  $V_{CC}$  Over Temperature

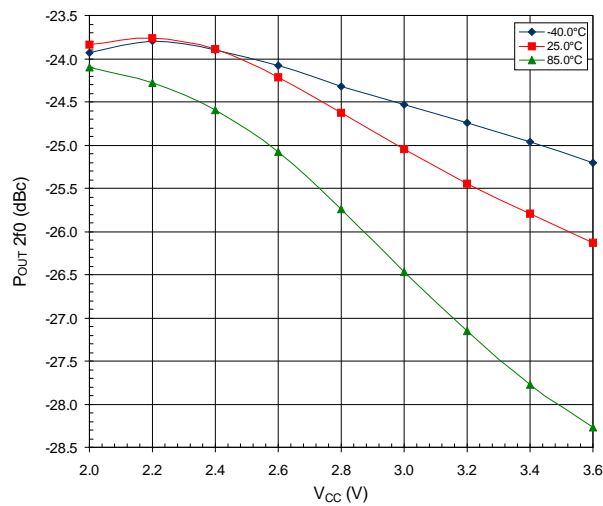

$P_{OUT}$  3f0 versus  $V_{CC}$  Over Temperature

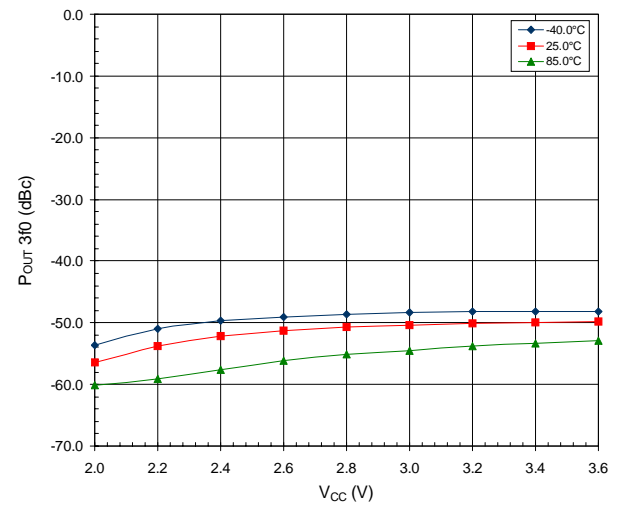

Carrier Suppression versus  $V_{CC}$  Over Temperature

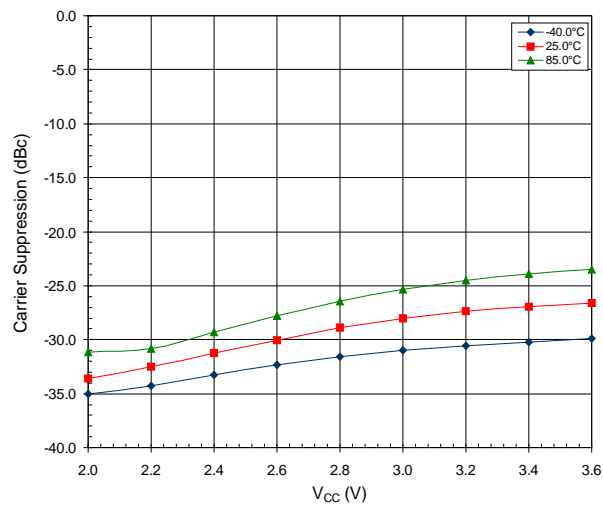

Carrier Suppression versus LO Amplitude Over Temperature

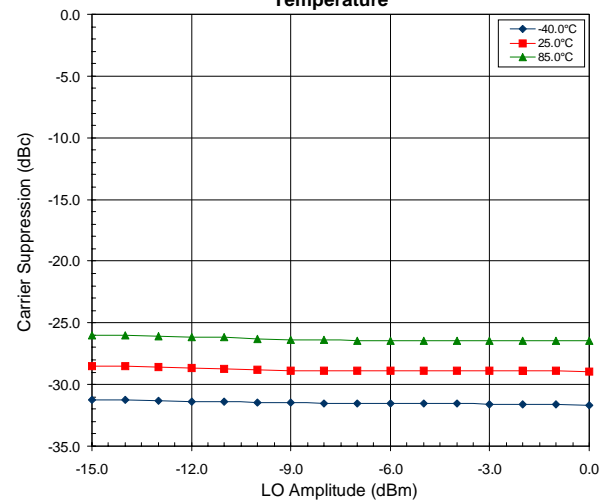

# RF2942

**Carrier Suppression versus LO Frequency Over Temperature**

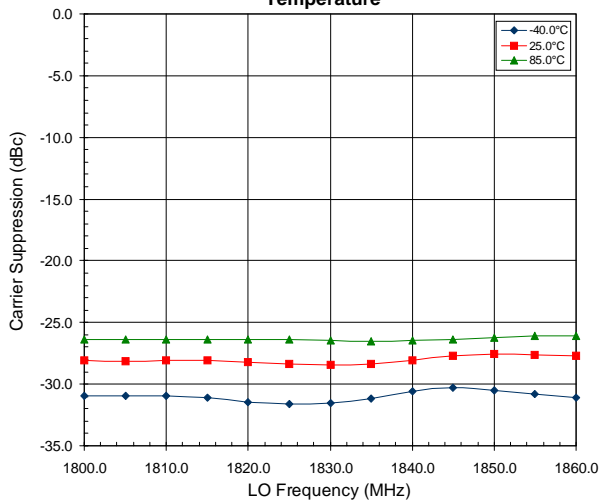

**Carrier Suppression versus I/Q Amplitude Over Temperature**

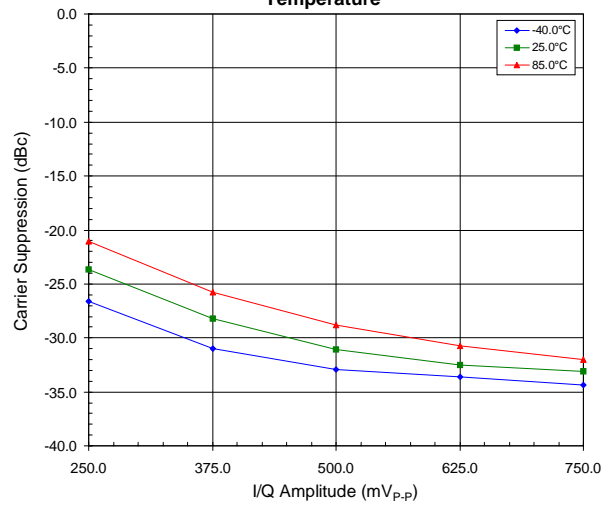

**Carrier Suppression versus I/Q Phase Over Temperature**

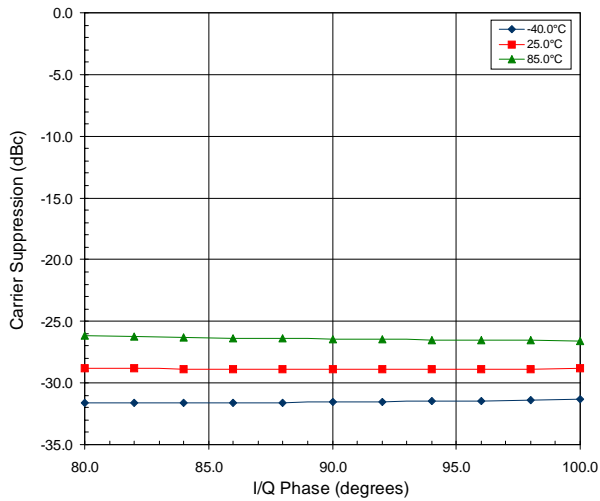

**Image Suppression versus V<sub>CC</sub> Over Temperature**

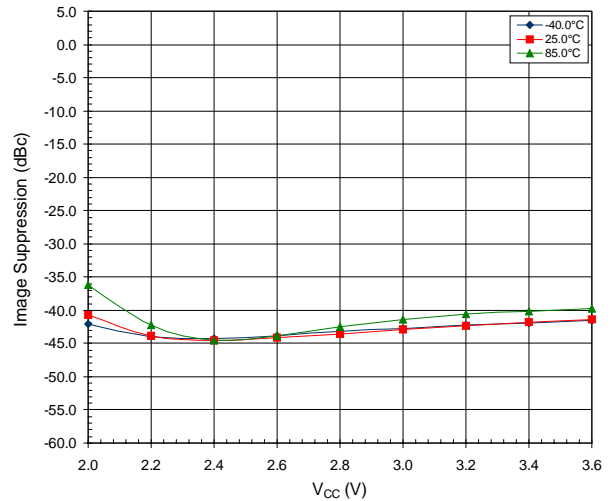

**Image Suppression versus LO Amplitude Over Temperature**

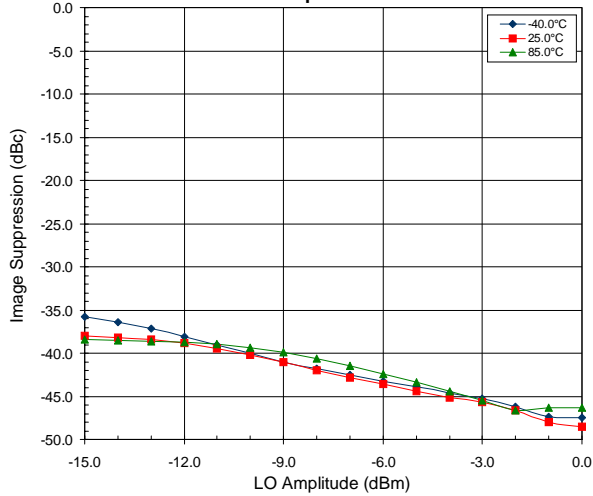

**Image Suppression versus LO Frequency Over Temperature**

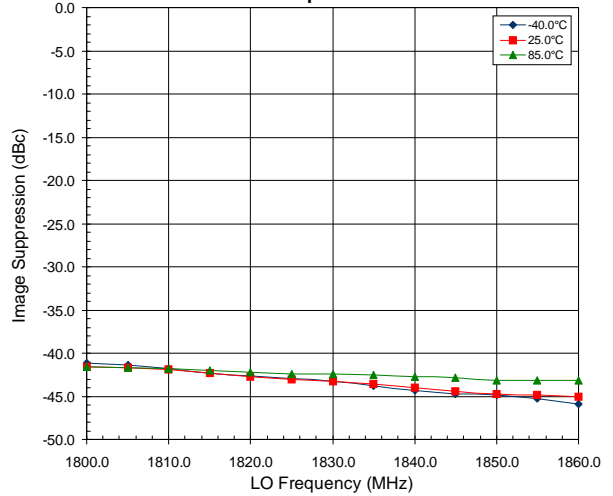

**Image Suppression versus I/Q Amplitude Over Temperature**

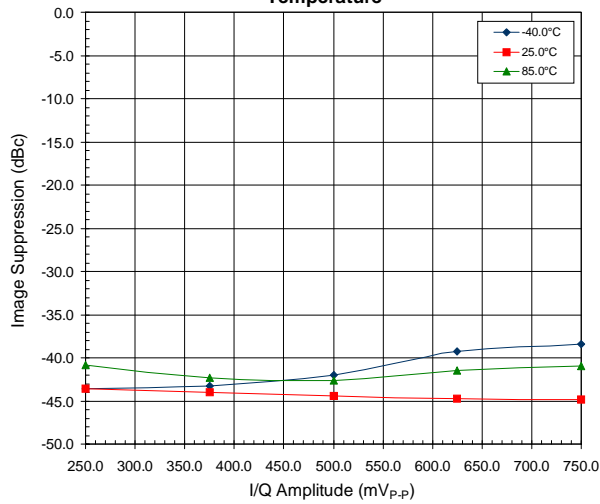

**Image Suppression versus I/Q Phase Over Temperature**

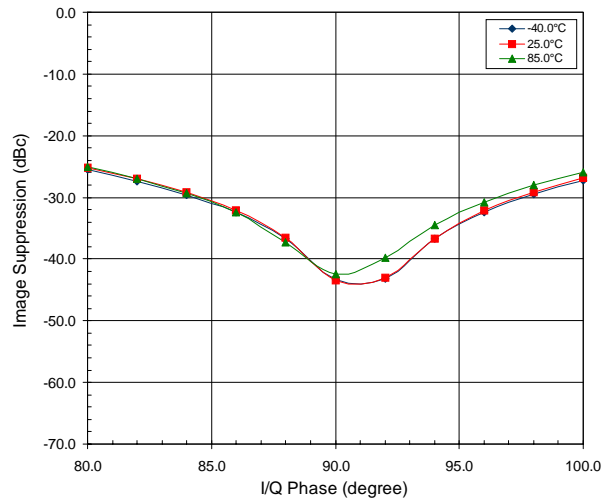

**LO Div2 Out versus V<sub>CC</sub> Over Temperature**

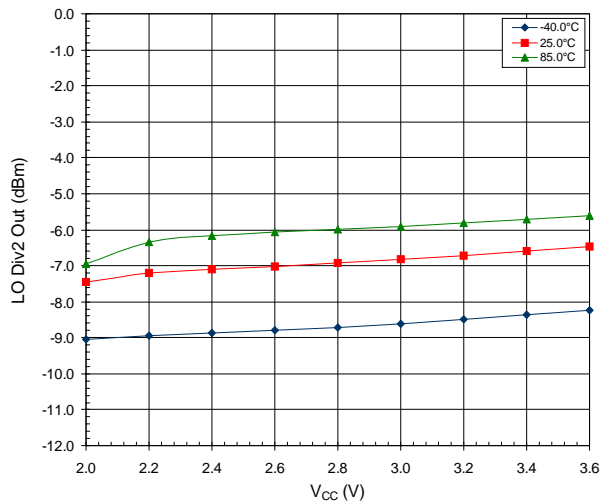

**LO Div2 Out versus LO Amplitude Over Temperature**

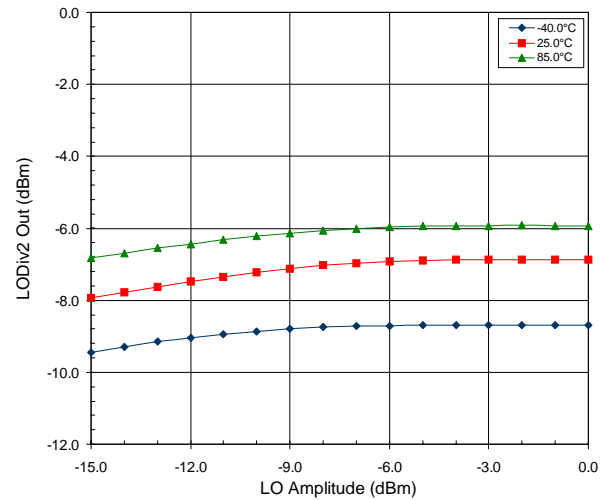

**LO Div2 Out versus LO Frequency Over Temperature**

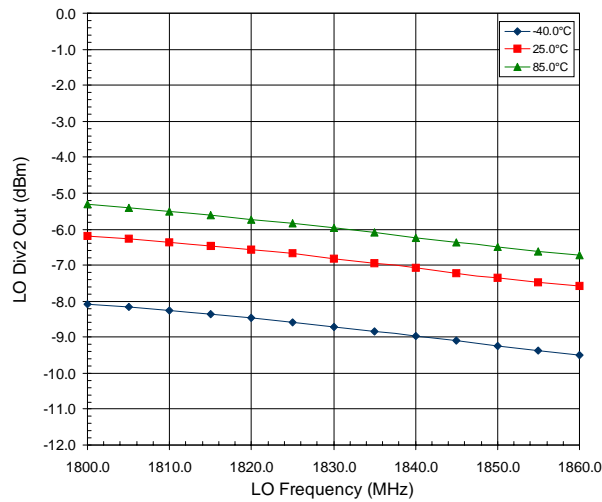

**LO Div2 Out versus I/Q Amplitude Over Temperature**

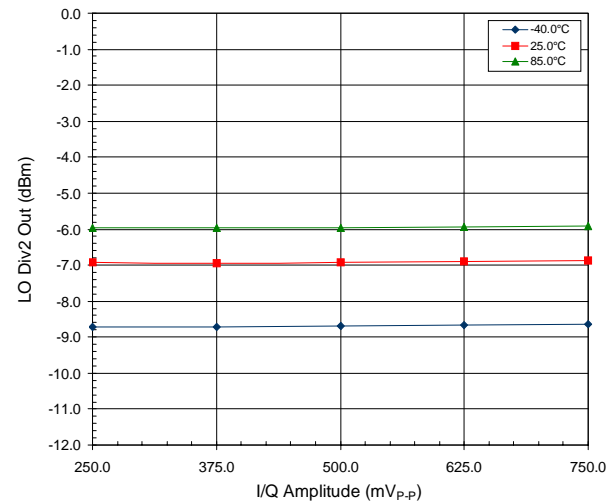

**RF2942**