

Typical Applications

- CATV Set-Top Boxes
- Cable Modems
- Cable-Ready TVs

Product Description

The RF3330 is a gain-controlled amplifier suitable for application in the IF receive section of a cable tuner. It consists of a high impedance differential input stage, a low impedance differential output stage, and a differential gain-controlled amplifier. The voltage gain may be varied by applying an analog control voltage. The device is fabricated on an advanced Bi-CMOS process, and is housed in an eight-lead SOT23 package.

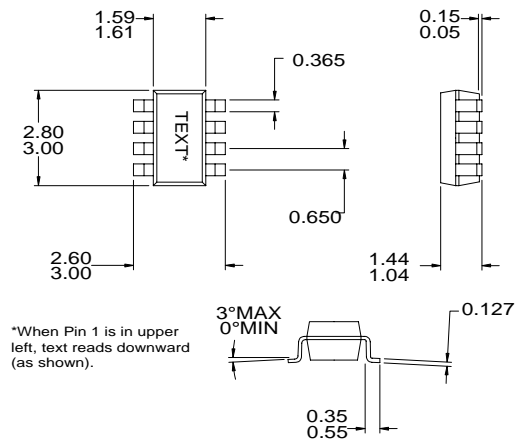

Optimum Technology Matching® Applied

- | | | |
|--|-----------------------------------|--------------------------------------|
| <input type="checkbox"/> Si BJT | <input type="checkbox"/> GaAs HBT | <input type="checkbox"/> GaAs MESFET |
| <input checked="" type="checkbox"/> Si Bi-CMOS | <input type="checkbox"/> SiGe HBT | <input type="checkbox"/> Si CMOS |

Package Style: SOT23-8

Features

- Single 5V Positive Power Supply
- 26dB Gain Range
- 150MHz Bandwidth
- Compact Package

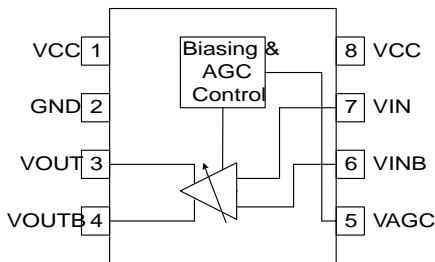

Functional Block Diagram

Ordering Information

RF3330	IF Gain Controlled Amplifier
RF3330 PCBA	Fully Assembled Evaluation Board - 75Ω
RF3330 PCBA	Fully Assembled Evaluation Board - 50Ω

RF Micro Devices, Inc. 7628 Thorndike Road Greensboro, NC 27409, USA	Tel (336) 664 1233 Fax (336) 664 0454 http://www.rfmd.com
--	---

Absolute Maximum Ratings

Parameter	Rating	Unit
Supply Voltage	7	V
Operating Ambient Temperature	-40 to +85	°C
Storage Temperature	-60 to +150	°C



Caution! ESD sensitive device.

RF Micro Devices believes the furnished information is correct and accurate at the time of this printing. However, RF Micro Devices reserves the right to make changes to its products without notice. RF Micro Devices does not assume responsibility for the use of the described product(s).

3

LINEAR CATV
AMPLIFIERS

Parameter	Specification			Unit	Condition
	Min.	Typ.	Max.		
Overall					Typical performance is at $T_A=+25^{\circ}\text{C}$, $V_{CC}=5\text{V}$.
DC Specifications					
Supply Voltage	4.75	5.0	5.25	V	0.5V=Minimum Gain 3.3V=Maximum Gain
Supply Current		18	25	mA	
AGC Control Voltage	0.5		3.3	V	
AGC Input Impedance		10		M Ω	
AC Specifications					
3dB Bandwidth		150		MHz	
Voltage Gain					
Maximum	33.0	34.0		dB	$V_{AGC}=3.3\text{V}$
Minimum		8.0	10.0	dB	$V_{AGC}=0.5\text{V}$
Maximum Input Level			50	dBmV(rms)	While meeting distortion specification
Maximum Output Level			50	dBmV(rms)	While meeting distortion specification
Output 1 dB Compression		66		dBmV(rms)	Maximum Gain
Output Harmonic Distortion		-44	-40	dBc	Output level=50dBmV(rms); $V_{AGC}=3.3\text{V}$
Input IP3, Maximum Gain		45		dBmV(rms)	Output level=50dBmV(rms); $V_{AGC}=3.3\text{V}$
Input IP3, Minimum Gain		60		dBmV(rms)	Output level=50dBmV(rms); $V_{AGC}=0.5\text{V}$
Input Noise, Maximum Gain		4.5		nV/rtHz	
Input Noise, Minimum Gain		42		nV/rtHz	
Output Impedance		10		Ω	Differential
Input Impedance		2000		Ω	Differential
Output Load Impedance	1			k Ω	Differential
Output Load Capacitance			2	pF	Differential

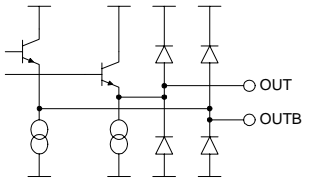
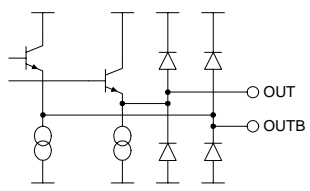
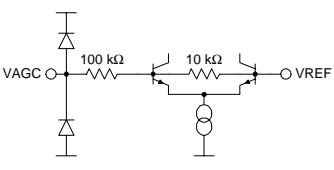
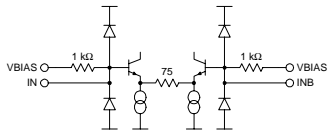
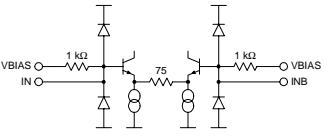
Pin	Function	Description	Interface Schematic
1	VCC	Supply Voltage	
2	GND	Supply Ground	
3	VOUT	Output pin.	
4	VOUTB	Complementary output pin.	
5	VAGC	AGC control voltage.	
6	VINB	Complementary input pin. This should be externally AC-coupled to signal source.	
7	VIN	Input pin. This should be externally AC-coupled to signal source.	
8	VCC	Supply Voltage	

Pin Out

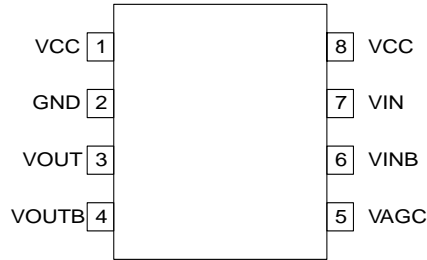

Application Schematic

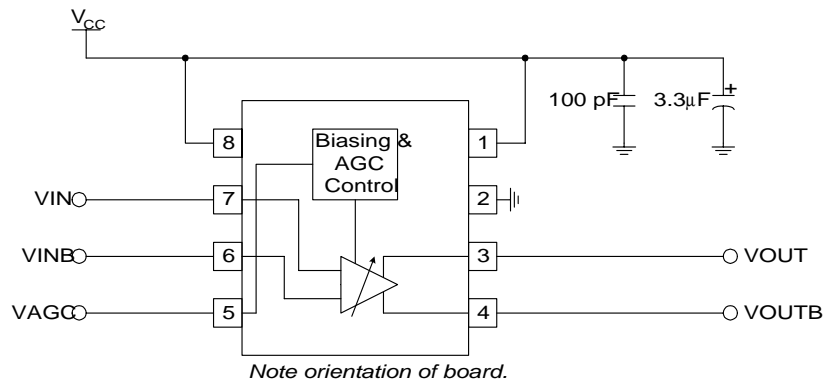

Evaluation Board Schematic

(Download [Bill of Materials](http://www.rfmd.com) from www.rfmd.com.)

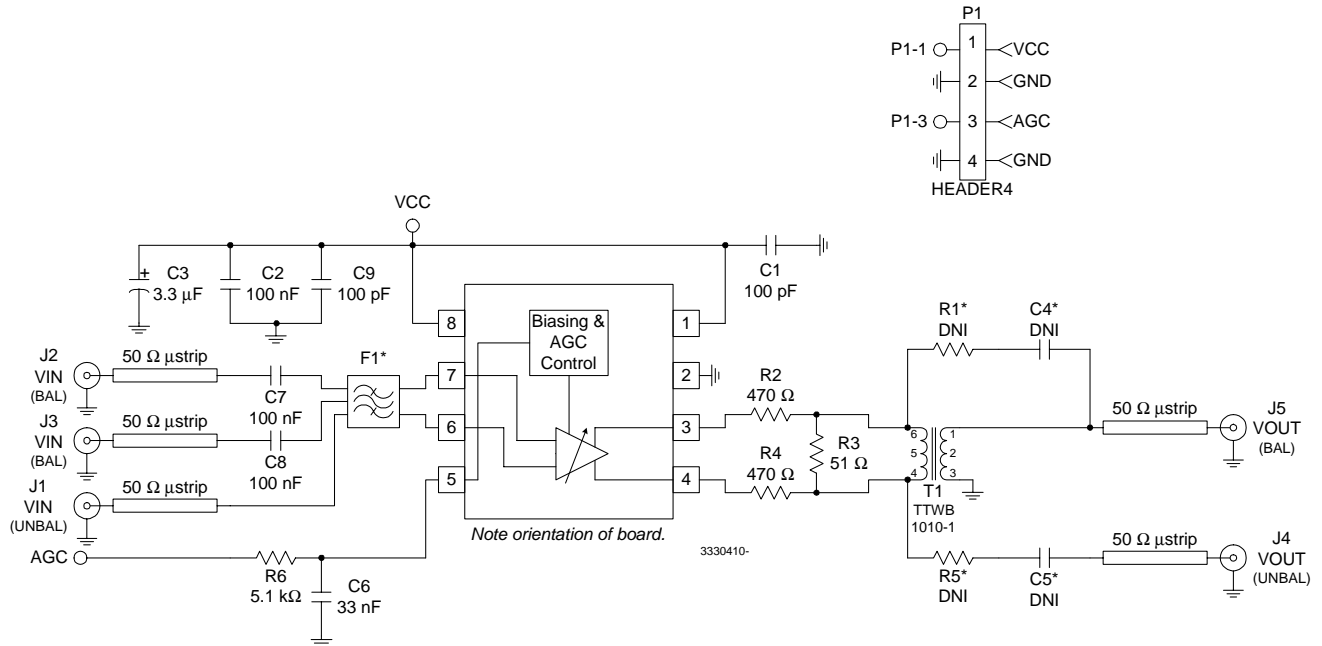

NOTES:

1. C3, Tantalum Capacitor: Case Size Y, 6.3 V.
2. See Evaluation Test Procedure for more information.
3. Parts with * following the reference designator should not be populated on the evaluation board.

Evaluation Board Layout
 Board Size 2.0" x 2.0"
 Board Thickness 0.062", Board Material FR-4

3
 LINEAR CATV
 AMPLIFIERS

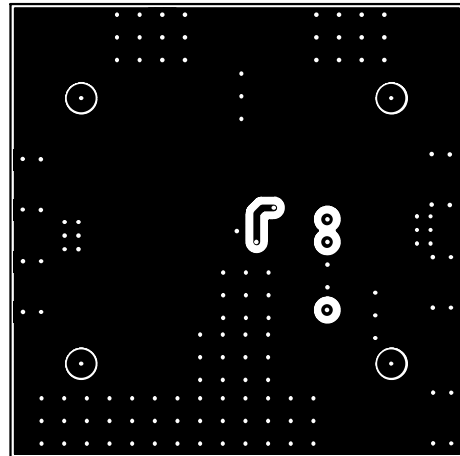
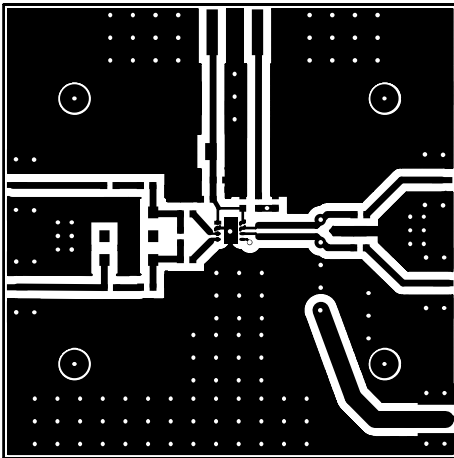
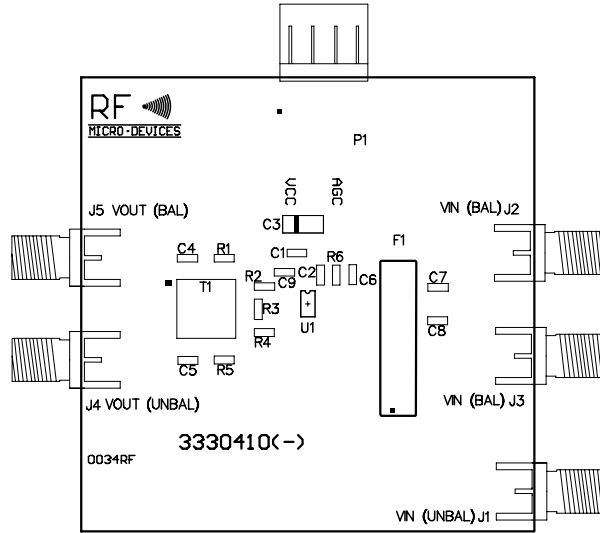

Evaluation Test Procedure

Introduction

The RF3330 is an IF amplifier with AGC, designed for use in Cable Television applications. Voltage gain is varied using an analog voltage control signal. The differential input is high impedance (2000 Ω) and the differential output is low impedance (10 Ω). The 3dB bandwidth is 150MHz and has a maximum voltage gain of 34dB and a minimum voltage gain of 8dB. The AGC Control Voltage ranges from 0.5V for minimum gain to 3.3V for maximum gain. The device is packaged in the SOT23-8, which minimizes board area.

Evaluation Board

The 3330410 board has been designed to achieve maximum versatility for device evaluation. The board is designed for either a differential or single-ended input signal. Likewise, the output can be either singly or differentially loaded. There is also a separate V_{CC} and AGC voltage pin. For constant maximum gain applications, the V_{CC} and AGC pins can be tied together.

Input

For differential operation on the input, the J1 connector (V_{IN} unbalanced) is not required. Differential voltages are applied directly through connectors J2 and J3 (V_{IN} balanced). DC blocking capacitors are also provided to protect equipment or upstream components. *Boards ordered from RF Micro Devices are assembled in this configuration.*

Single-ended operation on the input can be accomplished in two ways. The first option uses the differential board setup as described above, with the addition of an external low frequency 180° power combiner. The combiner splits the single input signal into two signals with inverted phase. The second option for single-ended operation utilizes a SAW filter which converts from double to single-ended. The current evaluation board has an option to insert a SAW filter on the input. For this setup, the J1 connector (V_{IN} unbalanced) would be utilized. The 3330410 board has been evaluated using a 44MHz Siemens+Matsushita filter. This is a common IF frequency used in cable modem applications.

Table 1. SAW Filters

EPCOS P/N	F_C (MHz)
X6857D	36.000
X6966M	36.125
X6964D	43.750
X6855M	44.000
X6866D	44.000
X6965M	44.000

Output

For differential operation on the output, the optional C4, C5, R1, and R5 would be inserted and the T1 transformer would be removed. The J4 (V_{OUT} unbalanced) and J5 (V_{OUT} balanced) connectors would be used as differential outputs.

For single-ended operation on the output, only the J4 connector (V_{OUT} unbalanced) is used and only one analyzer is necessary. There is a 1:1 transformer to convert the unbalanced output to a balanced signal. The amplifier is designed to drive a 1000 Ω load. Driving a 50 Ω load, presented by the spectrum analyzer will cause the amplifier to saturate. In order to present a 1000 Ω load to the amplifier a resistive matching circuit is on the board. *Boards ordered from RF Micro Devices are assembled in this configuration.*

Test Setup Calibration

Because of the fact that the impedances of the amplifier are not 50 Ω , there are some special considerations when calibrating a test setup. The evaluation test setup is shown in Figure 1.

Input

As stated previously, the balanced input impedance of the RF3330 is 2000 Ω . The signal generator used has an unbalanced 50 Ω source, and is typically used in unbalanced 50 Ω impedance systems. Due to this load mismatch, a positive amplitude offset needs to be applied to the signal generator. The formulas used to calculate this offset are given below in Equations 1 through 3. It should be noted that the unbalanced 1000 Ω load is used, because all data in the datasheet is referenced to single-ended operation. Using a spectrum analyzer probe, the actual offset measured was 7.5dB, and this is what is used for the amplitude offset in the signal generator.

$$\text{Mismatch Loss (ML)} = -10 \cdot \log(1 - |\Gamma_L|^2) \quad \text{Eq. 1}$$

$$\Gamma_L = (Z - Z_0) / (Z + Z_0) \quad \text{Eq. 2}$$

$$\text{ML} = -10 \cdot \log(1 - [(1000 - 50) / (1000 + 50)]^2) = 7.4 \text{ dB} \quad \text{Eq. 3}$$

Output

On the output, the losses due to the resistive matching pad must also be calibrated out of the setup. Because of the 1:1 transformer, the spectrum analyzer appears as a 50Ω resistor in parallel with this circuit (see Figure 2). Equation 4 illustrates the calculation necessary to obtain the amount of loss due to this matching circuit. The balun also has an additional 0.5dB to 1.0dB of

loss, which is added in to the overall output losses. This was verified with a spectrum analyzer probe. The offset used in the test setup is 32.5dB on the spectrum analyzer.

$$\text{Resistive Pad Loss} = 20 \cdot \log(25 / (470 + 25 + 470)) = -31.7 \text{ dB} \quad \text{Eq. 4}$$

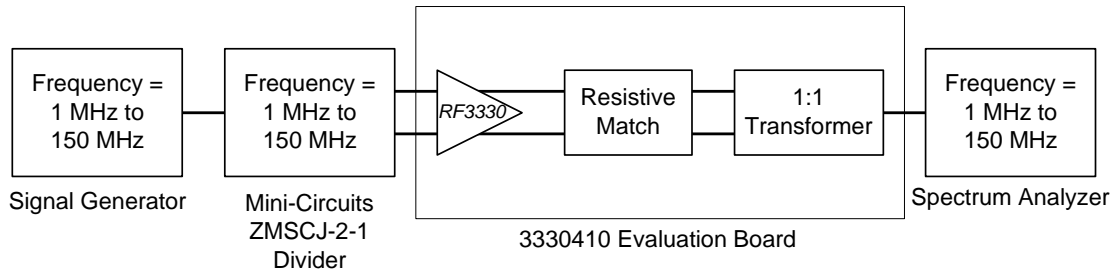

Figure 1. RF3330 Test Setup

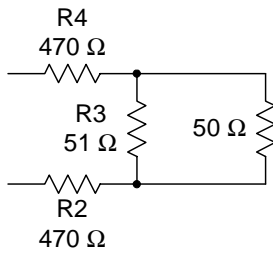

Figure 2. Equivalent Output Circuit

