

RF3932

60W GaN Wideband Power Amplifier

The RF3932 is a 48V, 60W high power discrete amplifier designed for commercial wireless infrastructure, cellular and WiMAX infrastructure, industrial/scientific /medical, and general purpose broadband amplifier applications. Using an advanced high power density gallium nitride (GaN) semiconductor process, these high-performance amplifiers achieve high efficiency and flat gain over a broad frequency range in a single amplifier design. The RF3932 is an unmatched GaN transistor, packaged in a hermetic flanged ceramic package. This package provides excellent thermal stability through the use of advanced heat sink and power dissipation technologies. Ease of integration is accomplished by incorporating simple, optimized matching networks external to the package that provide wideband gain and power performance in a single amplifier.



Package: Hermetic, 2-Pin, Flanged Ceramic

Features

- Broadband Operation DC to 3.5GHz
- Advanced GaN HEMT Technology
- Advanced Heat-Sink Technology
- Small Signal Gain = 14dB at 2GHz
- 48V Operation Typical Performance
 - Output Power: 75W at P3dB
 - Drain Efficiency = 68% at P3dB
 - -40°C to 85°C Operation

Applications

- Commercial Wireless Infrastructure
- Cellular and WiMAX Infrastructure
- Civilian and Military Radar
- General Purpose Broadband Amplifiers
- Public Mobile Radios
- Industrial, Scientific, and Medical

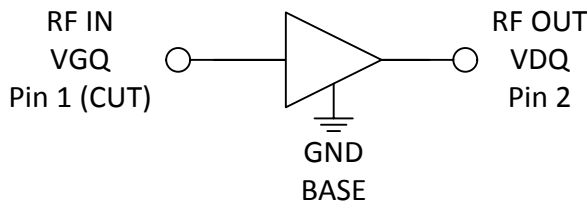

Functional Block Diagram

Ordering Information

RF3932S2	Sample bag with 2 pieces
RF3932SB	Bag with 5 pieces
RF3932SQ	Bag with 25 pieces
RF3932SR	Short Reel with 50 pieces
RF3932TR13	13" Reel with 400 pieces
RF3932PCBA-411	Fully assembled evaluation board optimized for 2.14GHz; 48V

Absolute Maximum Ratings

Parameter	Rating	Unit
Drain Voltage (V_D)	150	V
Gate Voltage (V_G)	-8 to +2	V
Gate Current (I_G)	39	mA
Operational Voltage	65	V
Ruggedness (VSWR)	10:1	
Storage Temperature Range	-55 to +125	°C
Operating Temperature Range (T_C)	-40 to +85	°C
Operating Junction Temperature (T_J)	200	°C
Human Body Model	Class 1A	
MTTF ($T_J < 200^\circ\text{C}$, 95% Confidence Limits)*	1.8E + 07	Hours
MTTF ($T_J < 250^\circ\text{C}$, 95% Confidence Limits)*	1.1E + 05	
Thermal Resistance, R_{TH} (junction to case) measured at $T_C = 85^\circ\text{C}$, DC bias only	2.6	°C/W



Caution! ESD sensitive device.



RFMD Green: RoHS compliant per EU Directive 2011/65/EU, halogen free per IEC 61249-2-21, <1000ppm each of antimony trioxide in polymeric materials and red phosphorus as a flame retardant, and <2% antimony solder.

Exceeding any one or a combination of the Absolute Maximum Rating conditions may cause permanent damage to the device. Extended application of Absolute Maximum Rating conditions to the device may reduce device reliability. Specified typical performance or functional operation of the device under Absolute Maximum Rating conditions is not implied.

* MTTF – Median time to failure as determined by the process technology wear-out failure mode. Refer to product qualification report for FIT (random) failure rate.

Operation of this device beyond any one of these limits may cause permanent damage. For reliable continuous operation, the device voltage and current must not exceed the maximum operating values specified in the table below.

Bias Conditions should also satisfy the following expression: $P_{DISS} < (T_J - T_C) / R_{TH\ J-C}$ and $T_C = T_{CASE}$

Nominal Operating Parameters

Parameter	Specification			Unit	Condition
	Min	Typ	Max		
Recommended Operating Conditions					
Drain Voltage (V_{DSQ})	28		48	V	
Gate Voltage (V_{GSQ})	-4.5	-3.7	-2.5	V	
Drain Bias Current		220		mA	
Frequency of Operation	DC		3500	MHz	
Capacitance					
C_{RSS}		5		pF	$V_G = -8V, V_D = 0V$
C_{ISS}		23		pF	
C_{OSS}		16.5		pF	
DC Functional Test					
$I_{G(OFF)}$ - Gate Leakage			2	mA	$V_G = -8V, V_D = 0V$
$I_{D(OFF)}$ - Drain Leakage			2.5	mA	$V_G = -8V, V_D = 48V$
$V_{GS(TH)}$ - Threshold Voltage		-4.2		V	$V_D = 48V, I_D = 10mA$
$V_{DS(ON)}$ - Drain Voltage at High Current		0.25		V	$V_G = 0V, I_D = 1.5A$

Parameter	Specification			Unit	Condition
	Min	Typ	Max		
RF Functional Test					Test Conditions: CW operation, $V_{DSQ} = 48V$, $I_{DQ} = 220mA$, $T = 25^{\circ}C$, Performance in a standard tuned test fixture
$V_{GS(Q)}$		-3.4		V	
Gain	11	13		dB	$P_{OUT} = 47.8dBm$, $f = 2140MHz$
Drain Efficiency	55	60		%	
Input Return Loss		-12		dB	
RF Typical Performance					Test Conditions: CW operation, $V_{DSQ} = 48V$, $I_{DQ} = 220mA$, $T = 25^{\circ}C$, Performance in a standard tuned test fixture
Small Signal Gain		21		dB	$f = 900MHz$
		14		dB	$f = 2140MHz$
Output Power at P3dB		48.80		dBm	$f = 900MHz$
		48.70		dBm	$f = 2140MHz$
Drain Efficiency at P3dB		68		%	$f = 900MHz$
		66		%	$f = 2140MHz$

Typical Performance in standard 2.14GHz fixed tuned test fixture
(CW, T = 25°C, unless noted)

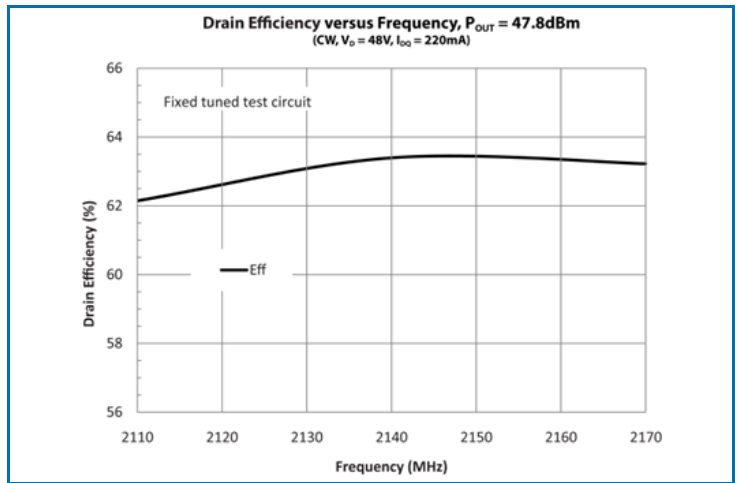
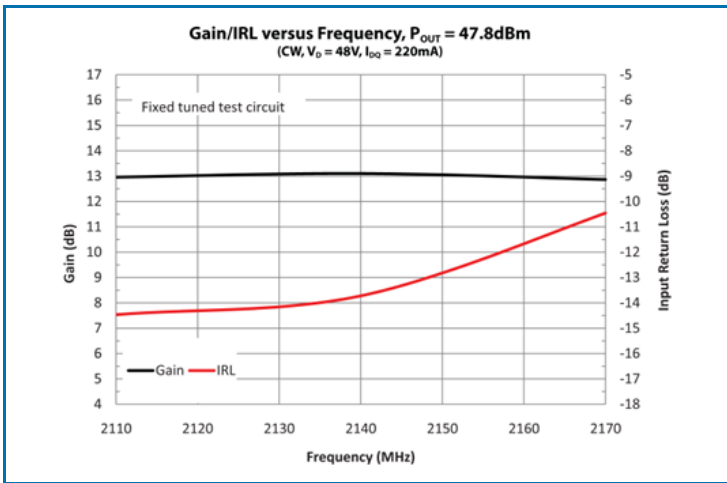
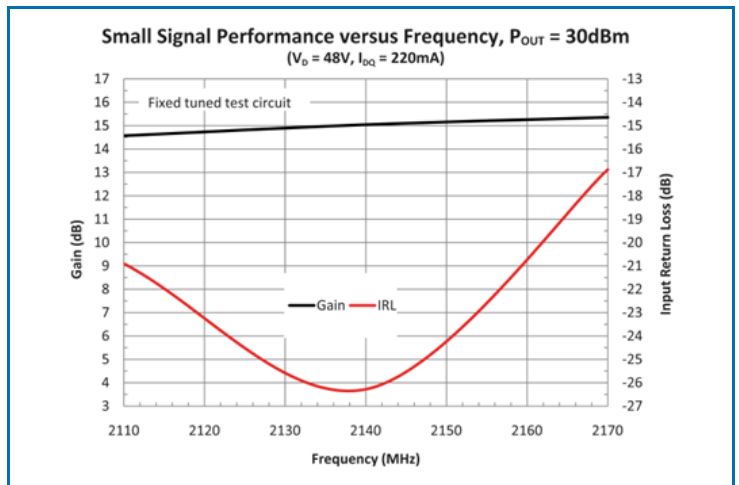
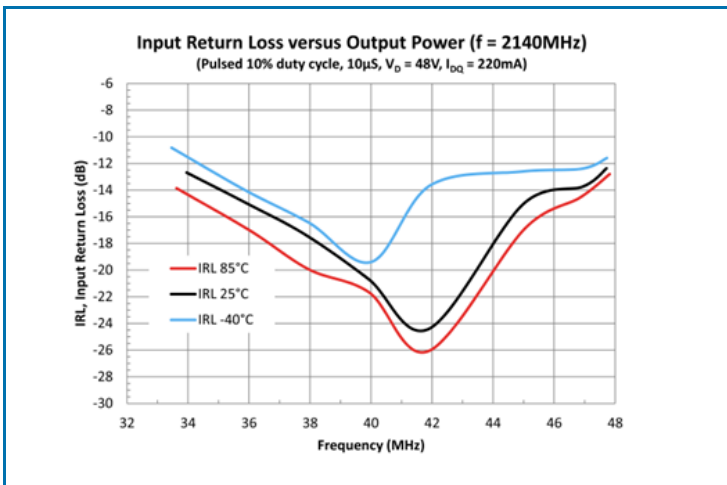
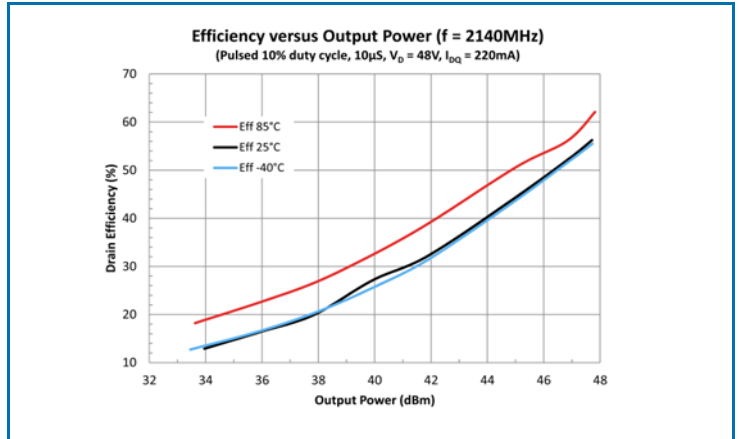
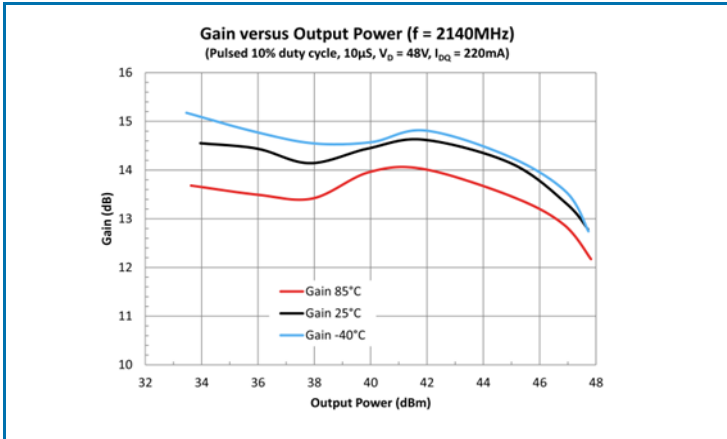

Typical Performance in standard 2.14GHz fixed tuned test fixture
(CW, T = 25°C, unless noted) (continued)

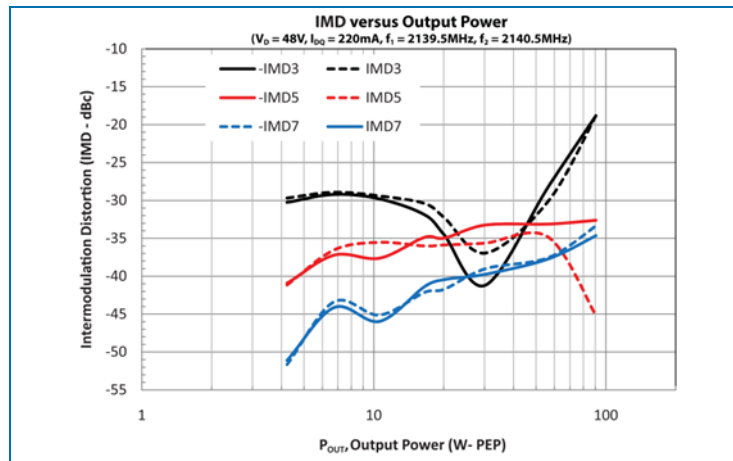
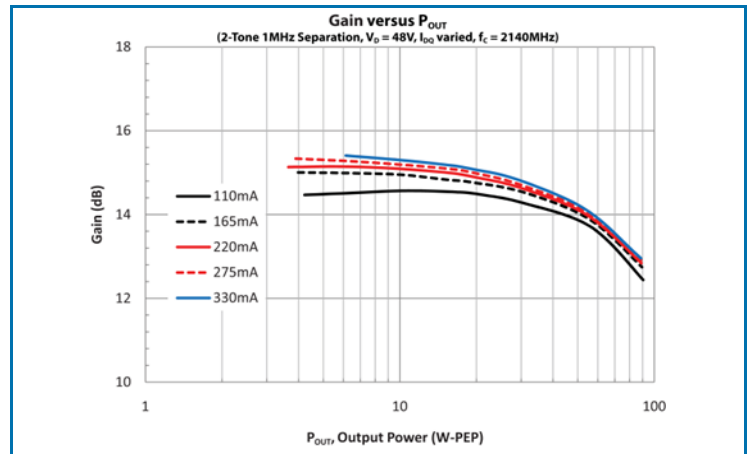
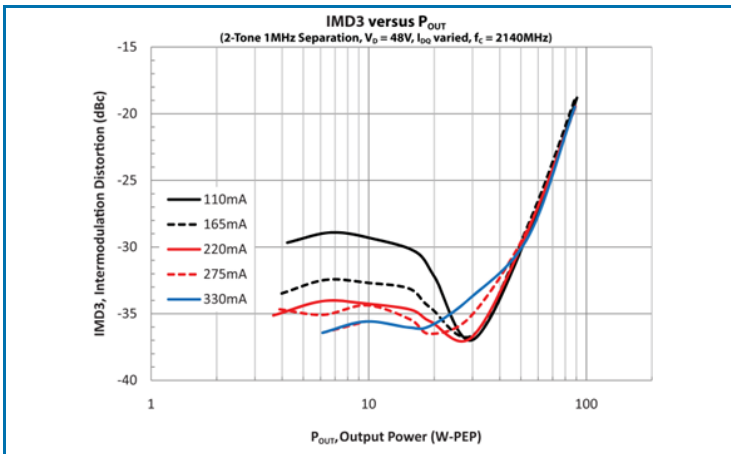
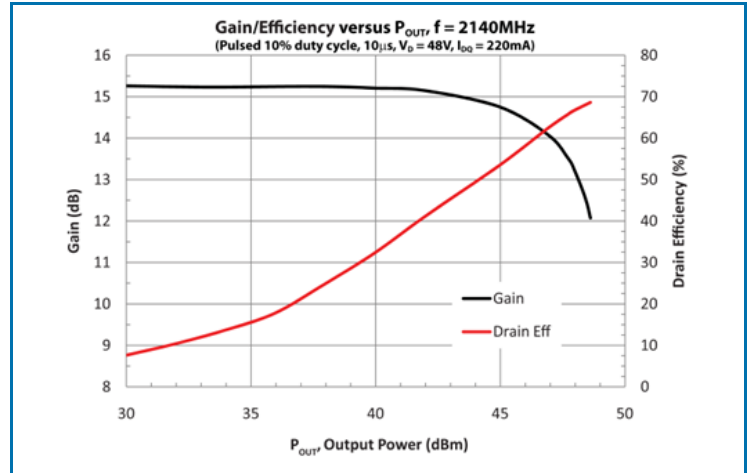
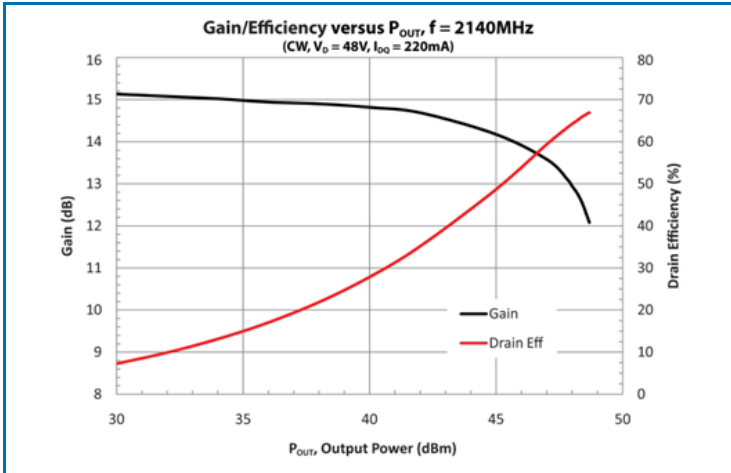

Typical Performance in standard 900MHz fixed tuned test fixture
(CW, T=25°C, unless noted)

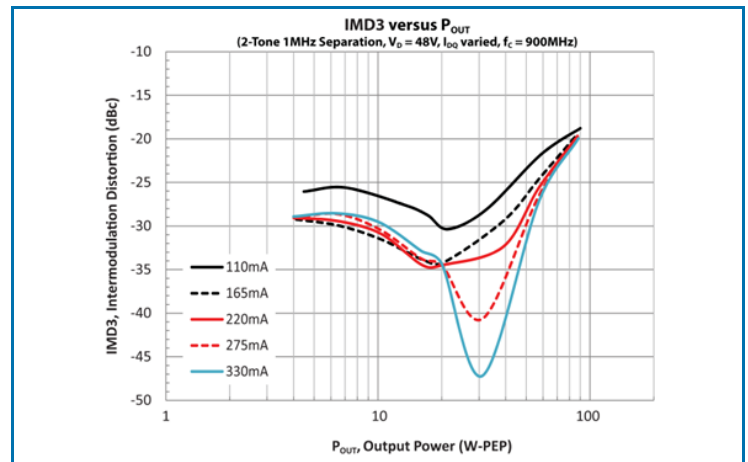
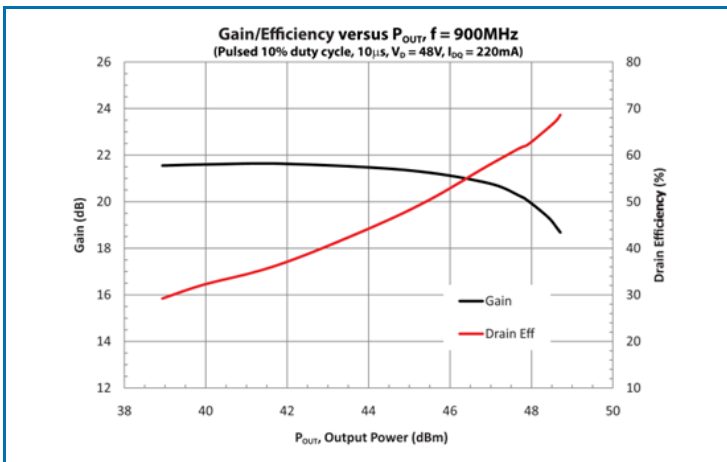
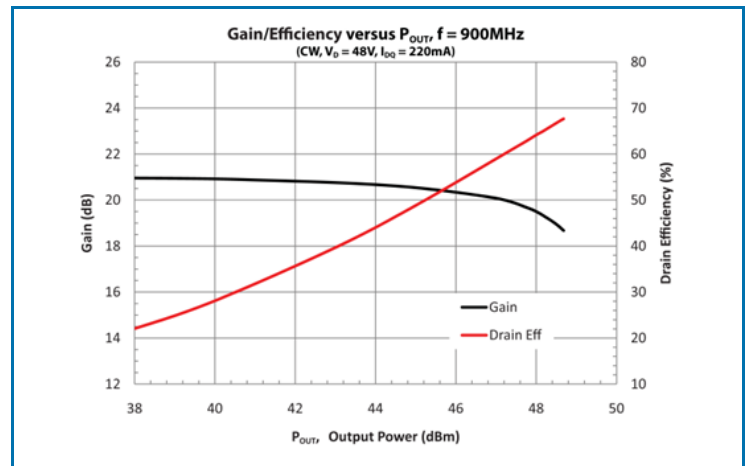
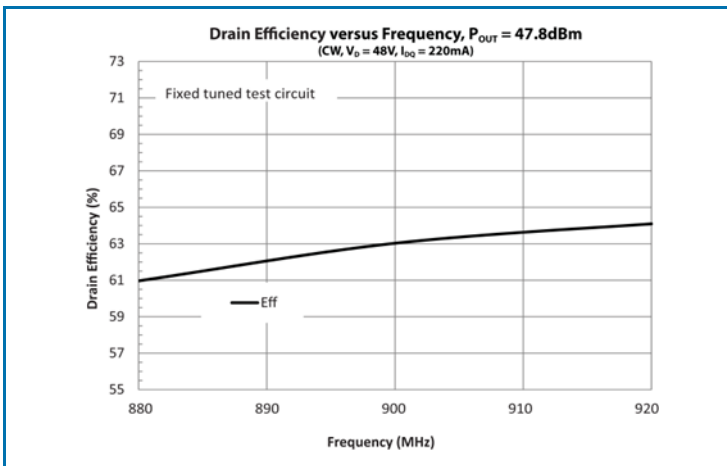
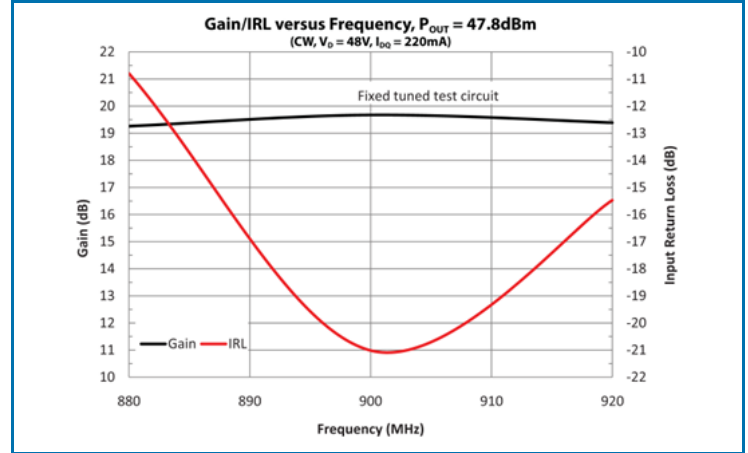
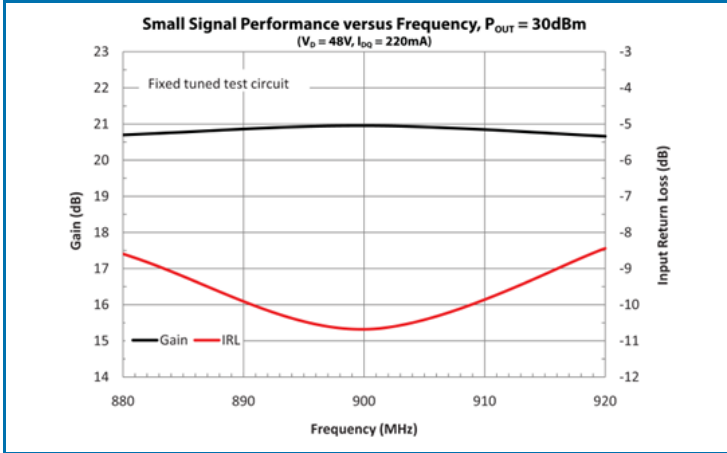

Typical Performance in standard 900MHz fixed tuned test fixture
(CW, T = 25°C, unless noted) (continued)

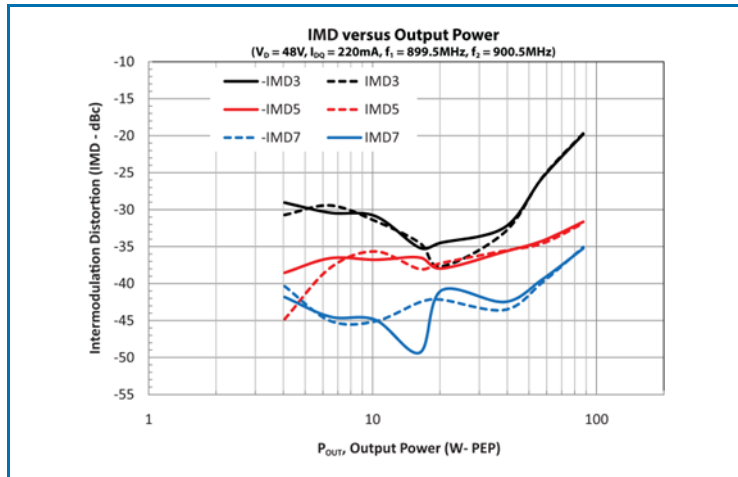
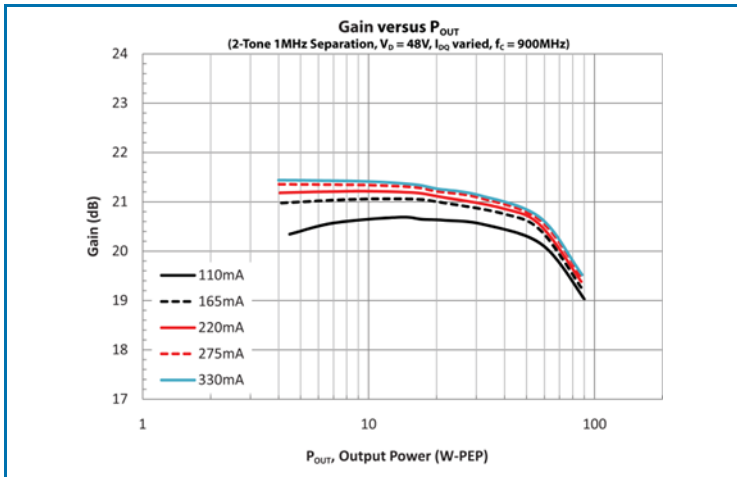

Package Drawing (Package Style: Flanged Ceramic)

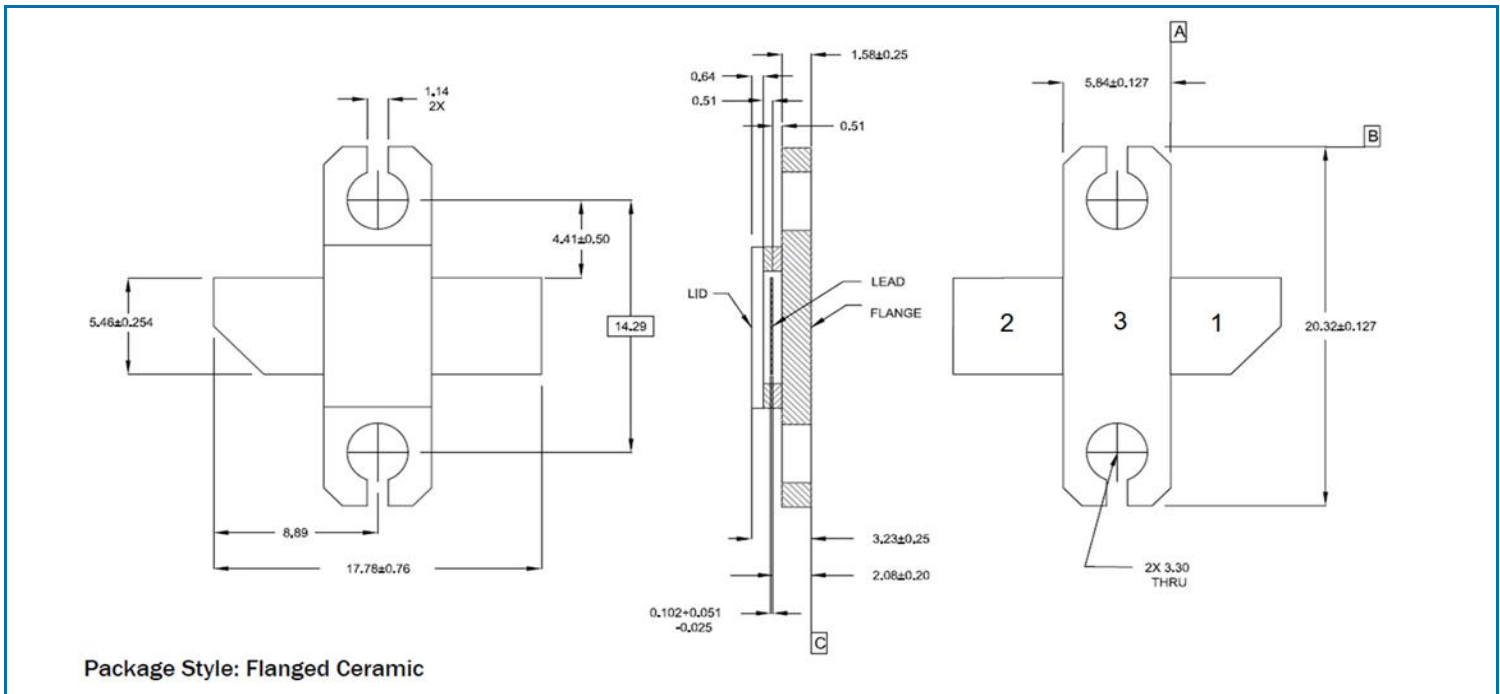

Pin Names and Descriptions

Pin	Name	Description
1	GATE	Gate - VG RF Input
2	DRAIN	Drain - VD RF Output
3	SOURCE	Source - Ground Base

Bias Instruction for RF3932 Evaluation Board

- ESD Sensitive Material. Please use proper ESD precautions when handling devices of evaluation board.
 - Evaluation board requires additional external fan cooling.
 - Connect all supplies before powering up the evaluation board.
1. Connect RF cables at RFIN and RFOUT.
 2. Connect ground to the ground supply terminal, and ensure that both the VG and VD grounds are also connected to this ground terminal.
 3. Apply -8V to VG.
 4. Apply 48V to VD.
 5. Increase V_G until drain current reaches desired 220mA bias point.
 6. Turn on RF input.

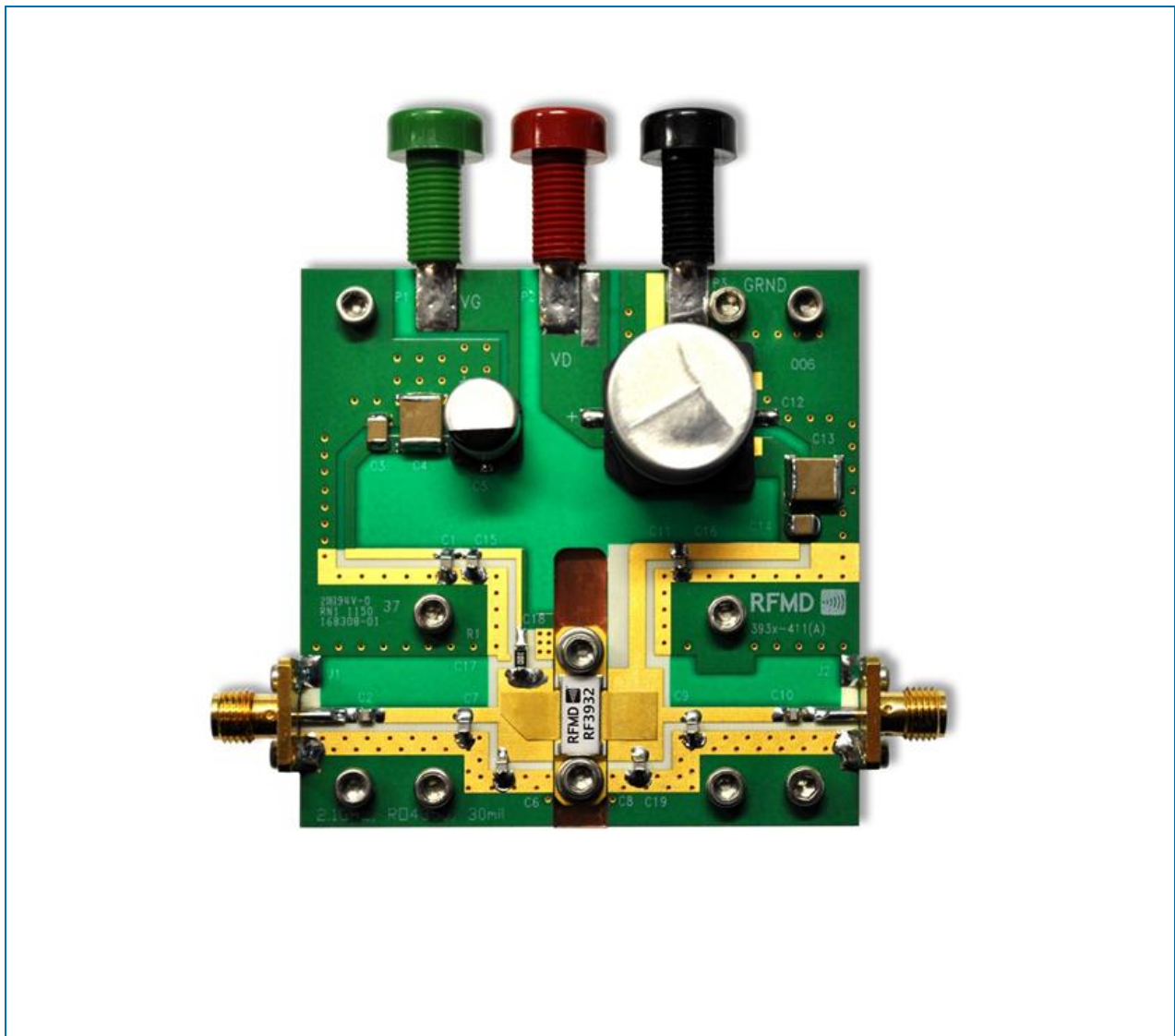

2.14GHz Evaluation Board Schematic

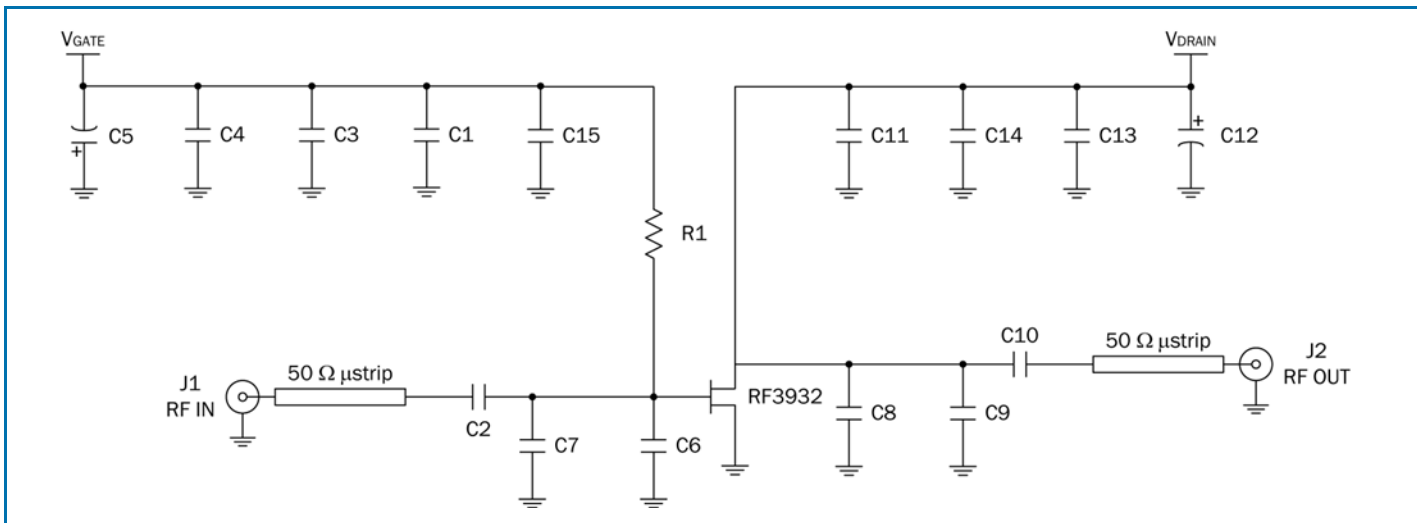

2.14GHz Evaluation Board Bill of Materials (BOM)

Item	Value	Manufacturer	Manufacturer's P/N
C1	10pF	ATC	ATC800A100JT
C2, C10, C11, C15	33pF	ATC	ATC800A330JT
C3, C14	0.1μF	Murata	GRM32NR72A104KA01L
C4, C13	4.7μF	Murata	GRM55ER72A475KA01L
C5	100μF	Panasonic	ECE-V1HA101UP
C6	2.2pF	ATC	ATC800A2R2BT
C7, C8	0.8pF	ATC	ATC800A0R8BT
C9	3.0pF	ATC	ATC800A3R0BT
C12	100μF	Panasonic	EEV-TG2A101M
R1	10Ω	Panasonic	ERJ-8GEYJ100V
C16, C17, C18, C19	Not used	-	-
PCB	RO4350, 0.030" thick dielectric	Rogers	-

2.14GHz Evaluation Board Layout

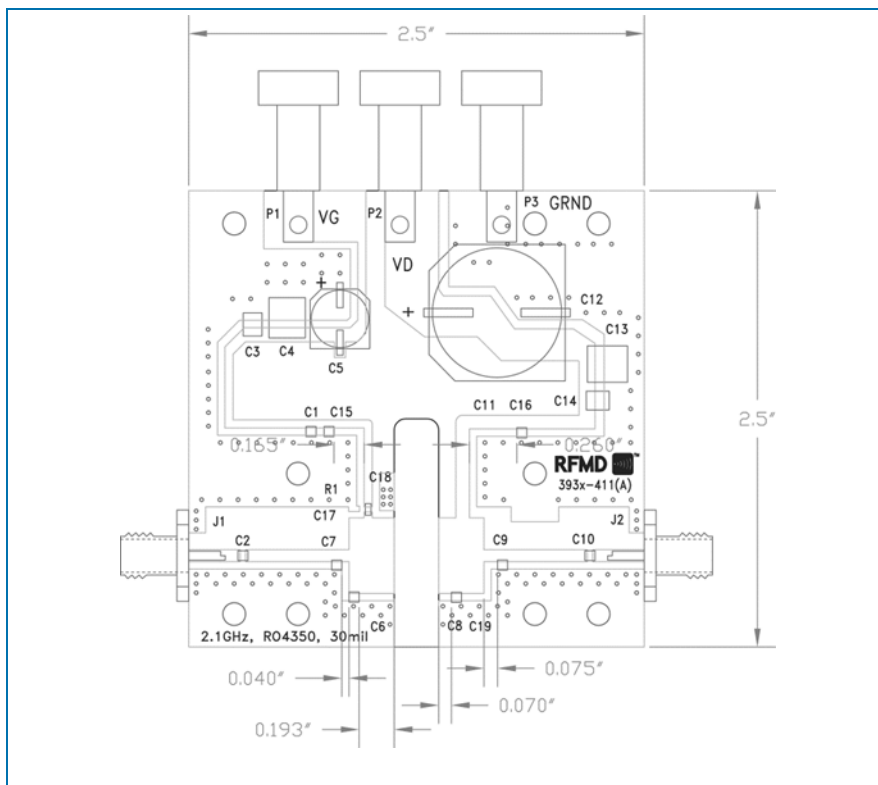

Device Impedances

Frequency (MHz)	Z Source (Ω)	Z Load (Ω)
2110	2.56 - j4.27	4.76 + j0.7
2140	2.45 - j3.94	4.77 + j1.3
2170	2.36 - j3.6	4.80 + j1.9

Note: Device impedances reported are the measured evaluation board impedances chosen for a tradeoff of efficiency, peak power, and linearity performance across the entire frequency bandwidth.

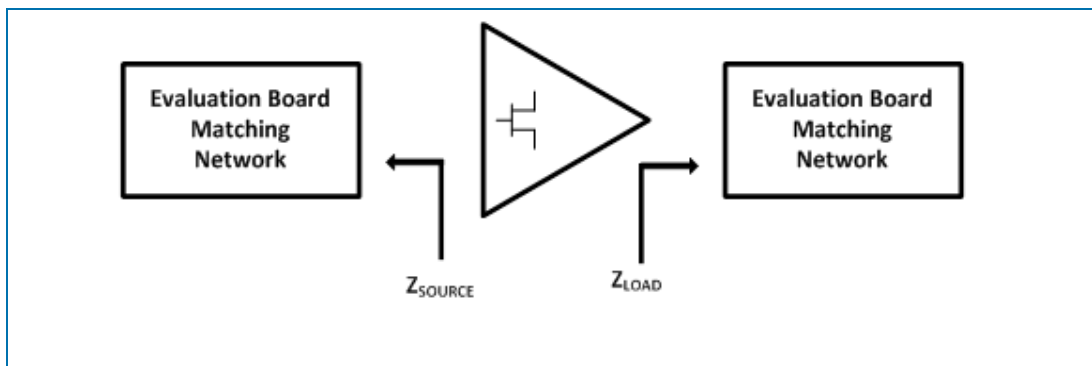

900MHz Evaluation Board Schematic

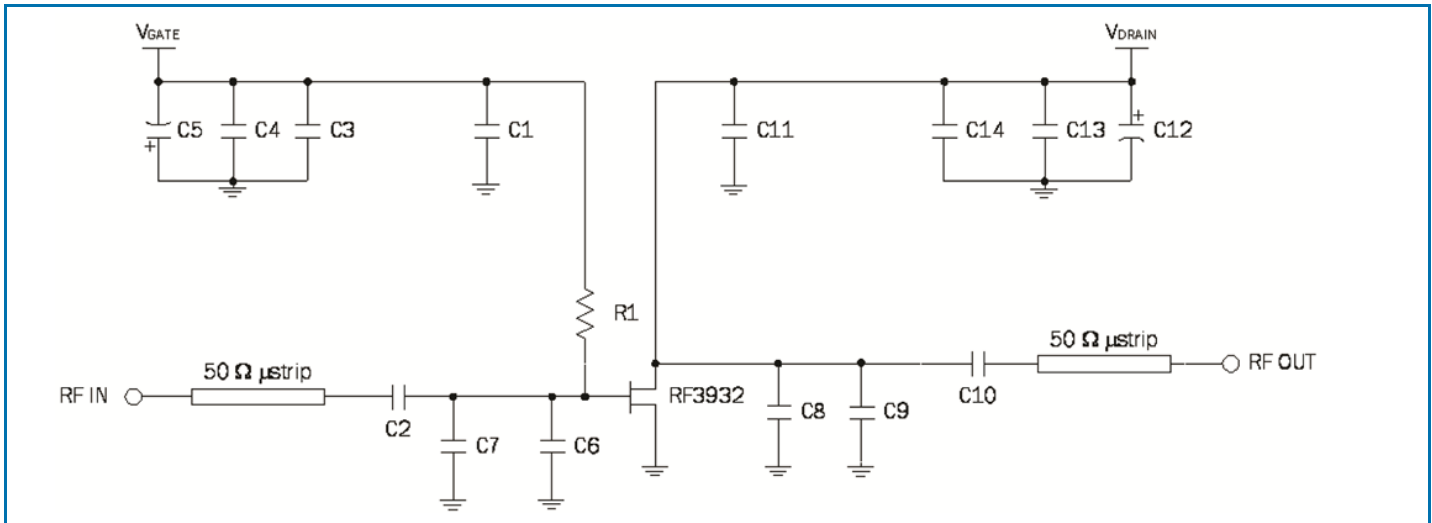

900MHz Evaluation Board Bill of Materials (BOM)

Item	Value	Manufacturer	Manufacturer's P/N
C1, C2, C10, C11	68pF	ATC	ATC100B680JT
C3, C14	0.1µF	Murata	GRM32NR72A104KA01L
C4, C13	4.7µF	Murata	GRM55ER72A475KA01L
C6	18pF	ATC	ATC800A180JT
C7	15pF	ATC	ATC800A150JT
C8	6.8pF	ATC	ATC100B6R8CT
C9	2.0pF	ATC	ATC100B2R0CT
C12	330µF	Panasonic	EEU-FC2A331
C5	100µF	Panasonic	ECE-V1HA101UP
R1	10Ω	Panasonic	ERJ-8GEYJ100V

900MHz Evaluation Board Layout

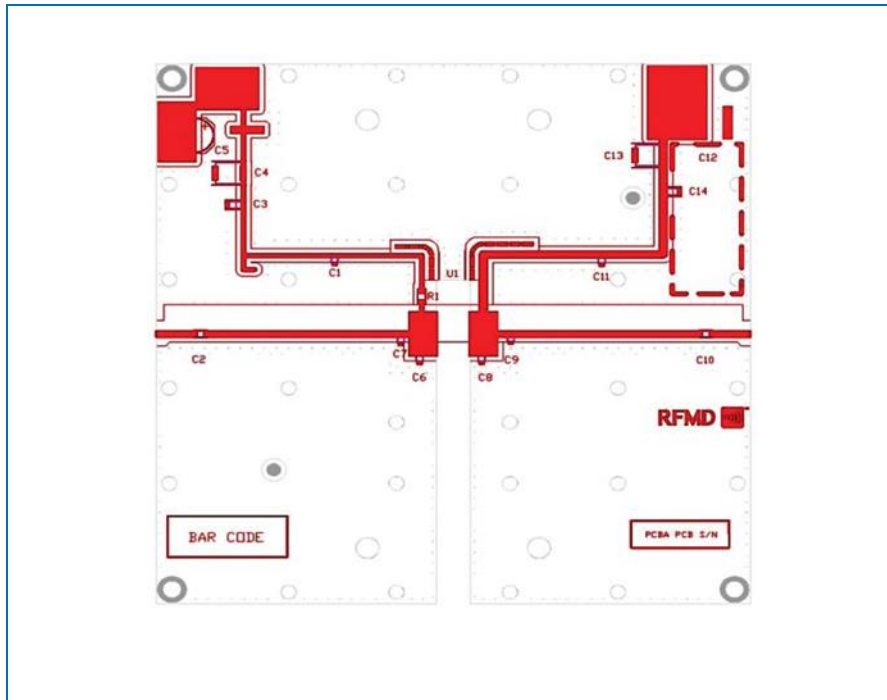

Device Impedances

Frequency (MHz)	Z Source (Ω)	Z Load (Ω)
880	$1.16 + j1.1$	$12.68 + j6.5$
900	$1.30 + j1.5$	$13.30 + j7.2$
920	$1.60 + j1.6$	$14.00 + j7.9$

Note: Device impedances reported are the measured evaluation board impedances chosen for a tradeoff of efficiency, peak power, and linearity performance across the entire frequency bandwidth.

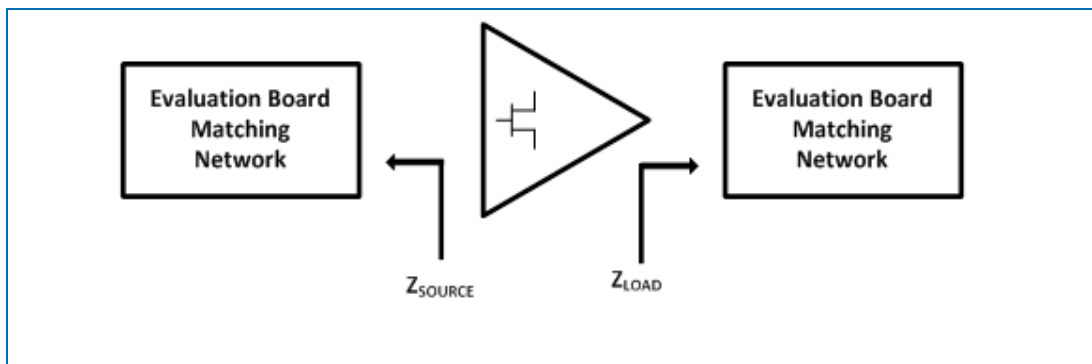

Device Handling/Environmental Conditions

GaN HEMT devices are ESD sensitive materials. Please use proper ESD precautions when handling devices or evaluation boards.

GaN HEMT Capacitances

The physical structure of the GaN HEMT results in three terminal capacitors similar to other FET technologies. These capacitances exist across all three terminals of the device. The physical manufactured characteristics of the device determine the value of the C_{DS} (drain to source), C_{GS} (gate to source) and C_{GD} (gate to drain). These capacitances change value as the terminal voltages are varied. RFMD presents the three terminal capacitances measured with the gate pinched off ($V_{GS} = -8V$) and zero volts applied to the drain. During the measurement process, the parasitic capacitances of the package that holds the amplifier is removed through a calibration step. Any internal matching is included in the terminal capacitance measurements. The capacitance values presented in the typical characteristics table of the device represent the measured input (C_{ISS}), output (C_{OSS}), and reverse (C_{RSS}) capacitance at the stated bias voltages. The relationship to three terminal capacitances is as follows:

$$C_{ISS} = C_{GD} + C_{GS}$$

$$C_{OSS} = C_{GD} + C_{DS}$$

$$C_{RSS} = C_{GD}$$

DC Bias

The GaN HEMT device is a depletion mode high electron mobility transistor (HEMT). At zero volts V_{GS} the drain of the device is saturated and uncontrolled drain current will destroy the transistor. The gate voltage must be taken to a potential lower than the source voltage to pinch off the device prior to applying the drain voltage, taking care not to exceed the gate voltage maximum limits. RFMD recommends applying $V_{GS} = -5V$ before applying any V_{DS} .

RF Power transistor performance capabilities are determined by the applied quiescent drain current. This drain current can be adjusted to trade off power, linearity, and efficiency characteristics of the device. The recommended quiescent drain current (I_{DQ}) shown in the RF typical performance table is chosen to best represent the operational characteristics for this device, considering manufacturing variations and expected performance. The user may choose alternate conditions for biasing this device based on performance trade-offs.

Mounting and Thermal Considerations

The thermal resistance provided as R_{TH} (junction to case) represents only the packaged device thermal characteristics. This is measured using IR microscopy capturing the device under test temperature at the hottest spot of the die. At the same time, the package temperature is measured using a thermocouple touching the backside of the die embedded in the device heat-sink but sized to prevent the measurement system from impacting the results. Knowing the dissipated power at the time of the measurement, the thermal resistance is calculated.

In order to achieve the advertised MTTF, proper heat removal must be considered to maintain the junction at or below the maximum of 200°C. Proper thermal design includes consideration of ambient temperature and the thermal resistance from ambient to the back of the package including heat-sinking systems and air flow mechanisms. Incorporating the dissipated DC power, it is possible to calculate the junction temperature of the device.