



RF5163

3V-5V, 2.5GHZ LINEAR POWER AMPLIFIER

RoHS Compliant & Pb-Free Product

Typical Applications

- 802.11b/g/n Access Points
- PCS Communication Systems
- 2.4GHz ISM Band Applications
- Commercial and Consumer Systems
- Portable Battery-Powered Equipment
- Broadband Spread-Spectrum Systems

Product Description

The RF5163 is a linear, medium-power, high-efficiency amplifier IC designed specifically for low voltage operation. The device is manufactured on an advanced Gallium Arsenide Heterojunction Bipolar Transistor (HBT) process, and has been designed for use as the final RF amplifier in 802.11b/g/n access point transmitters. The device is provided in a 4mmx4mm, 16-pin, leadless chip carrier with a backside ground. The RF5163 is designed to maintain linearity over a wide range of supply voltage and power output.

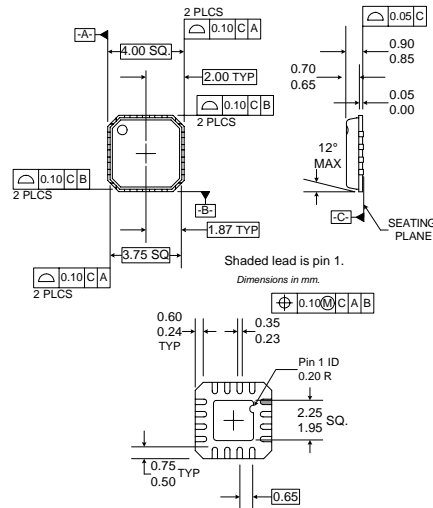

Optimum Technology Matching® Applied

- | | | |
|-------------------------------------|--|---------------------------------------|
| <input type="checkbox"/> Si BJT | <input checked="" type="checkbox"/> GaAs HBT | <input type="checkbox"/> GaAs MESFET |
| <input type="checkbox"/> Si Bi-CMOS | <input type="checkbox"/> SiGe HBT | <input type="checkbox"/> Si CMOS |
| <input type="checkbox"/> InGaP/HBT | <input type="checkbox"/> GaN HEMT | <input type="checkbox"/> SiGe Bi-CMOS |

Package Style: QFN, 16-Pin, 4 x 4

Features

- Single 3.3V or 5V Power Supply
- +33dBm Saturated Output Power (typ.)
- 20dB Large Signal Gain (typ.)
- 2.0% EVM @ +26dBm, 54Mbps (typ.)
- Separate Power Detect/Power Down Pins
- 1800MHz to 2500MHz Frequency Range

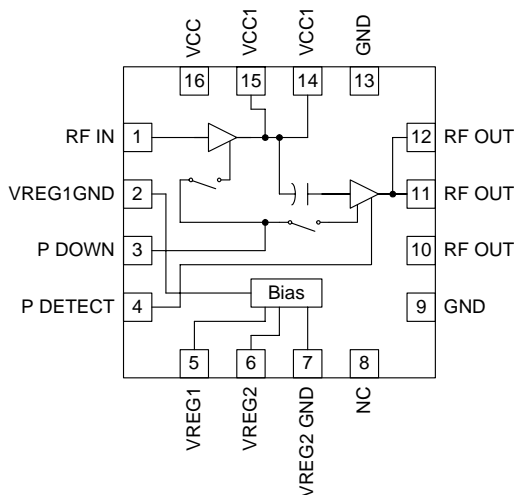

Functional Block Diagram

Ordering Information

- RF5163 3V-5V, 2.5GHz Linear Power Amplifier, Matte-Sn (Pb-free) Finish
- RF5163L 3V-5V, 2.5GHz Linear Power Amplifier, Sn-Pb Finish
- RF5163PCBA-41X Fully Assembled Evaluation Board
- RF5163PCBA-WD Fully Assembled Evaluation Board, With Driver

RF Micro Devices, Inc.
7628 Thorndike Road
Greensboro, NC 27409, USA

Tel (336) 664 1233
Fax (336) 664 0454
<http://www.rfmd.com>

RF5163

Absolute Maximum Ratings

Parameter	Rating	Unit
Supply Voltage	-0.5 to +5.5	V _{DC}
Power Control Voltage (V _{PC})	-0.5 to 3.3	V
DC Supply Current	1000	mA
Input RF Power	+15	dBm
Operating Ambient Temperature	-10 to +85	°C
Storage Temperature	-40 to +150	°C
Moisture sensitivity	JEDEC Level 3	



Caution! ESD sensitive device.

RF Micro Devices believes the furnished information is correct and accurate at the time of this printing. RoHS marking based on EU Directive 2002/95/EC (at time of this printing). However, RF Micro Devices reserves the right to make changes to its products without notice. RF Micro Devices does not assume responsibility for the use of the described product(s).

Parameter	Specification			Unit	Condition
	Min.	Typ.	Max.		
Overall					T=25 °C, V _{CC} =5.0V, V _{REG1,2} =3V, Freq=2450MHz
Frequency Range		2400 to 2500		MHz	
Compliance					IEEE802.11g and IEEE802.11b
Output Power		+26		dBm	With 802.11g modulation (54 Mbit/s) and meeting 802.11g spectral mask @ <2.5% maximum EVM (RMS, mean).
EVM		2.0		%	Increase over EVM floor; RF P _{OUT} =+26dBm
Gain		20		dB	@ +6dBm RF Pin
Input Impedance				Ω	Please see Theory of Operation.
Output VSWR			10:1		No oscillation
Power Down					
V _{CC} and V _{CC1} are "ON"			0.6	V _{DC}	Pin 3 (P_DOWN) Voltage < 0.6V _{DC}
V _{CC} and V _{CC1} are "OFF"		4.0	5.0	V _{DC}	Pin 3 (P_DOWN) Voltage > 2.5V _{DC}
Power Supply					
Operating Voltage		3.0 to 5.0		V	
Current Consumption		520		mA	Power Down "ON", P _{OUT} =+26dBm
		260		mA	Idle current
V _{REG} (Bias) Voltage (V _{REG1} , V _{REG2})		3.0		V	
V _{REG} (Bias) Current (Total)		5		mA	

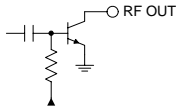
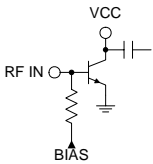
Pin	Function	Description	Interface Schematic
1	RF IN	RF input. Matching network with DC-block required; see evaluation board schematic for details.	See pin 14.
2	VREG1 GND	First stage bias circuit ground. Keep PCB traces short and connect immediately to ground plane.	
3	P DOWN	Power down pin. Apply $<0.6V_{DC}$ to power up both V_{CC} and V_{CC1} . Apply $2.5V_{DC}$ to $3.5V_{DC}$ to power down. If function is not desired pin may be grounded.	
4	P DETECT	The P_DOWN and P_DETECT pins can be used in conjunction with an external feedback path to provide an RF power control function for the RF5163. The power control function is based on sampling the RF drive to the final stage of the RF5163. If function is not desired, pin may be left unterminated.	
5	VREG1	First stage bias input - requires regulated voltage to maintain desired I_{CC} .	
6	VREG2	Second stage bias input - requires regulated voltage to maintain desired I_{CC} . May be tied to pin 5 input after series resistors.	
7	VREG2 GND	Second stage bias circuit ground. Ground with a 10nH inductor.	
8	NC	No connect (N/C).	
9	GND	Ground connection. For best performance, keep PCB trace lengths short.	
10	RF OUT	Same as pin 11.	
11	RF OUT	RF output and bias for the output stage. The power supply for the output transistor needs to be supplied to this pin. This can be done through a quarter-wave ($\lambda/4$) microstrip line that is RF grounded at the other end, or through an RF inductor that supports the required DC current.	
12	RF OUT	Same as pin 11.	
13	GND	Same as pin 8.	
14	VCC1	Power supply pin for first stage. External low frequency bypass capacitors should be connected if no other low frequency decoupling is employed.	
15	VCC1	Same as pin 14.	
16	VCC	Power supply pin for bias circuits. External low frequency bypass capacitors should be connected if no other low frequency decoupling is employed.	
Pkg Base	GND	Ground connection. The back side of the package should be connected to the ground plane through as short a connection as possible, e.g., PCB vias under the device are recommended.	See pins 1 and 2.

Theory of Operation and Application Information

RF5163PCBA Evaluation Board

The RF5163 is a two-stage device with a nominal gain of 20dB in the 2.4GHz to 2.5GHz Industrial, Scientific, and Medical (ISM) band. The RF5163 is designed primarily for fixed IEEE802.11g/n WLAN applications requiring exceptionally linear RF output powers of +23dBm to +28dBm.

The RF5163 requires a single positive supply of 5.0V nominal to operate to full specifications. Power control is provided through two (2) separate and independent methods. The first method is through two (2) bias control pins (V_{REG1} and V_{REG2}). In most applications, both V_{REG1} and V_{REG2} are tied together and used as a single control input. The second method is through the use of a dedicated Power Down (P_Down) pin. Applying less than ($<$) $0.6V_{DC}$ to the RF5163 P_Down pin fully turns "ON" both V_{CC} and V_{CC1} power circuits. Applying $2.5V_{DC}$ to $3.5V_{DC}$ to the RF5163 P_Down pin fully turns "OFF" both V_{CC} and V_{CC1} circuits. Turning the RF5163 "ON" and/or "OFF" by using the P_Down pin is accomplished without regard to system voltage regulator turn-on and turn-off settling time restraints.

There is some external matching on the input and output of the RF5163, thus allowing the RF5163 to be used in other applications outside the 2.4GHz to 2.5GHz ISM band (such as IEEE802.16d/e in the 2.3GHz band). Both the input and output of the device require a series DC-blocking capacitor. In some cases, a capacitor used as a matching component can also serve as the blocking cap. The circuits used on the RF5163PCBA and RF5163PCBA-WD Evaluation Boards are optimized for $V_{CC}=+5.0V_{DC}$ operation.

The RF5163 is not difficult to implement, however, care in printed circuit board layout and component selection is highly recommended when implementing 2.5GHz capable circuits. Critical passive components in the RF5163PCBA Evaluation Board circuit are interstage and output matching components (C13, C15, and C16). In these cases, high-Q (Quality factor) capacitors suitable for RF application are used on the evaluation board (an evaluation board bill of material (BOM) is available upon request). High-Q components are not required in every design, but it is strongly recommended that the initial design be implemented with the same components used on the RF5163PCBA Evaluation Board. After establishing initial baseline performance, less costly components may be substituted to evaluate performance impact.

The input matching inductor L1 and the DC blocking capacitor C14 helps to tune the peak of the small-signal gain response as well as improve the linearity of the PA. The input impedance of the PA will not be 50Ω with this input match so do not use a Smith Chart for guidance for value selection and parts placement. With a 50Ω input into the input match as shown on the Evaluation Board schematic, the PA will perform as expected with an expected input return loss of \sim -2dB. The input L1 should be placed with reference to the position as shown on the RF5163PCBA Evaluation Board schematic.

The interstage matching capacitor, C13, along with the combined inductance of the internal bond wire, the short length of circuit board trace, and the parasitic inductance of the capacitor, tunes the peak of the small-signal gain response. The trace length between C13 and RF5163 pins 14 and 15 should be kept as close to the evaluation board schematic as possible.

The output matching capacitors are C15 and C16. These capacitors are placed with reference to position along transmission line segments TL1 and TL2, as shown on the RF5163PCBA Evaluation Board schematic. These segments should be duplicated as closely as possible. Due to variations in FR-4 characteristics and PCB manufacturer process variations, some benefit is obtained from small adjustments to TL1 and TL2 length when the evaluation board is duplicated. Prior to full scale manufacturing, the board layout of early prototypes should include some additional exposed ground areas around C15 and C16 to optimize this part of the circuit. The AC coupling capacitor, C10, may be placed very close to C15. The output match is complete at C15.

R3 at RF5163 pin 4 (P_Detect) desensitizes the P_Detect line from the value of C12. Without R3, the value of C12 may affect error vector magnitude (EVM) under certain operational conditions.

The RF5163 has primarily been characterized with a voltage on V_{REG1} and V_{REG2} of $+3.0V_{DC}$. However, the RF5163 will operate from a wide range of control voltages. If a different control voltage is desired, contact RFMD Sales or Applications Engineering for additional data and guidance.

RF5163PCBA-WD Evaluation Board:

The RF5163PCBA-WD Evaluation Board was developed to assist prospective customers of the RF5163 with a completely characterized medium to high power amplifier solution incorporating a highly linear driver amplifier stage. In applications requiring more than 20dB to 22dB amplifier stage gain, the RF5163PCBA-WD Evaluation Board design may be employed to achieve higher gain combined with ultra linear RF power output for high peak-to-average power ratio applications (e.g., orthogonal frequency division multiplex (OFDM) modulation).

Figure 1 below shows the major component line-up for an ultra linear fixed application (e.g., an access point (AP)) transmitter capable of producing $+26\text{dBm}$ RF P_{OUT} with an amplifier stage (driver + final stage power amplifier IC, RF2373 + RF5163) EVM contribution of $< 2.5\%$ EVM, RMS (mean).

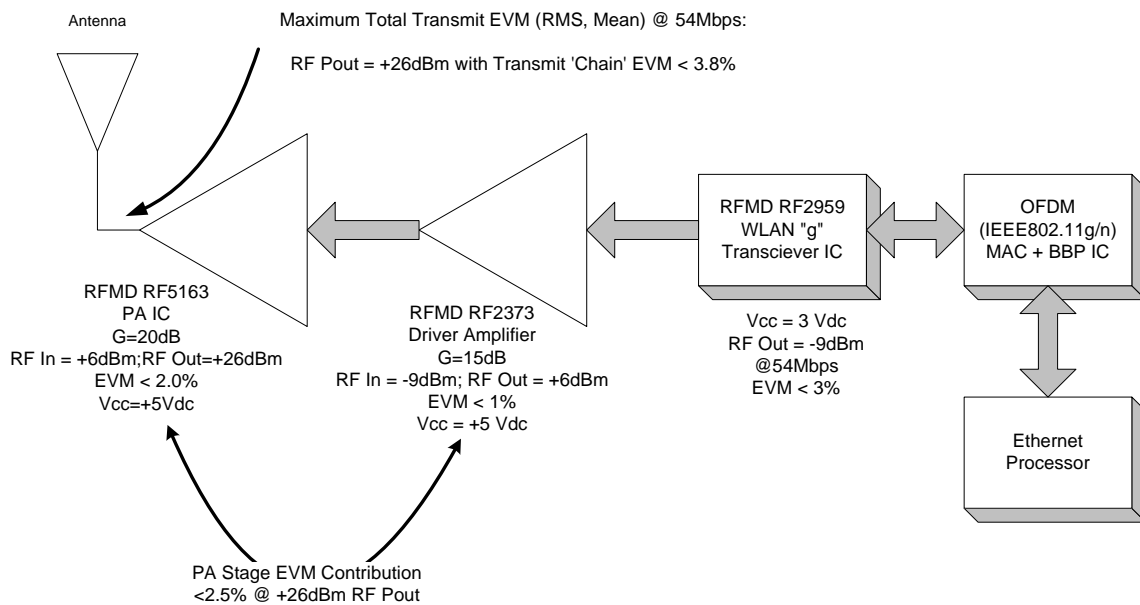

Figure 1. IEEE802.11g/n AP Transmitter Major Component Line-Up

RF5163

The RF5163PCBA-WD Evaluation Board employs the RF2373 as a driver amplifier at the input to the RF5163 (as final stage power amplifier IC). The RF2373 is a very high linearity single stage low noise amplifier (LNA)/driver amplifier that demonstrates approximately 15dB of gain from 2400MHz to 2500MHz and is capable of delivering +6dBm RF P_{OUT} at < 1% EVM (RMS, mean). The RF5163PCBA-WD Evaluation Board is designed to maximize both useful gain and ultra linear transmit power performance. Typical RF5163PCBA-WD Evaluation Board specifications are shown in the Table below:

Typical RF5163PCBA-WD Evaluation Board Specifications:

Parameter	Min.	Typ.	Max.	Unit	Condition
Frequency Range	2400		2500	MHz	T=25°C, V _{CC} =+5.0V _{DC} ; All V _{REG} voltages=+3.0V _{DC}
Output Power		+26		dBm	
EVM			2.5	%	RMS, mean (IEEE802.11g/n; Maximum Data Rate)
Gain		33	40	dB	-10dBm RF Pin
Power Supply					
Operating Voltage (V _{CC})		5.0		V _{DC}	
Bias Voltage (V _{REG})		3.0		V _{DC}	
Current Consumption		660		mA	RF P _{OUT} =+26dBm; RF PIN=-10dBm; P_Down is "ON", IEEE802.11g/n Modulation @ Maximum Data Rate

All application information described above for the RF5163PCBA Evaluation Board applies directly to the RF5163PCBA-WD Evaluation Board.

On the RF5163PCBA-WD Evaluation Board schematic, reference designator U1 identifies the RF2373 and reference designator U2 identifies the RF5163. V_{CC} (nominal+5.0V_{DC}) is supplied to both U1 (RF2373) and U2 (RF5163) simultaneously through P2, two-pin header connector. V_{CC} is applied to the RF2373 through RF2373 pin 4 (RF OUT). Inductor L4 is positioned to isolate the power supply line from C7 (RF2373 output tuning capacitor).

R3 on RF2373 pin 3 sets the bias current for RF2373 V_{BIAS} voltage. As employed within the RF5163PCBA-WD Evaluation Board, the RF2373 is biased for V_{BIAS} voltage of +3.0V_{DC}. RF2373 bias voltage is supplied through P3, two-pin header connector.

Critical RF5163 input and output tuning components are L2, C11, C13, C16, and C17. The resistor values for R7 and R8 have changed from the original values in the RF5163 evaluation board schematic. Critical RF2373 input and output tuning components are C6, C7 and L4. In these cases, high-Q capacitors suitable for RF applications are used on the RF5163PCBA-WD Evaluation Board (bill of material (BOM) is available upon request). 50Ω transmission line segments are employed at both the input and output of the RF2373. It is strongly recommended that the construction of these transmission line segments be followed as closely as possible to yield best gain, gain flatness, and linear amplifier driver performance.

The RF5163PCBA-WD Evaluation Board includes two (2) locations where separate and independent 3dB loss pads may be populated. These two (2) 3dB loss pads are provided to reduce the overall gain of the RF2373+RF5163 amplifier combination (which can achieve 40dB gain if not reduced through the use of the available 3dB loss pads). If no gain reduction is desired simply place resistors R11 and R2 as zero (0) resistor values. If only a single 3dB loss pad is desired for circuit operation it is recommended to use the R9, R10, R11 3dB loss pad positioned in series with and before RF2373 pin 1 (RF IN). Place resistor R2 as a zero (0) value resistor.

The RF5163PCBA-WD Evaluation Board has been characterized with a V_{CC} voltage of +5.0V_{DC}, RF5163 V_{REG1} and V_{REG2} voltage of +3.0V_{DC}, and RF2373 bias (V_{BIAS} or V_{PD}) voltage of +3.0V_{DC}. These are ideal operating conditions to achieve the best combination of gain and ultra linear transmitter performance at an RF P_{OUT}=+26dBm. However, the RF5163PCBA-WD Evaluation Board will operate from a wide range of V_{CC} and control voltages. If a different set of V_{CC} and/or control voltages is desired, contact RFMD Sales or Applications Engineering for additional data and guidance.

Evaluation Board Schematic RF5163PCBA Evaluation Board (2400MHz to 2500MHz)

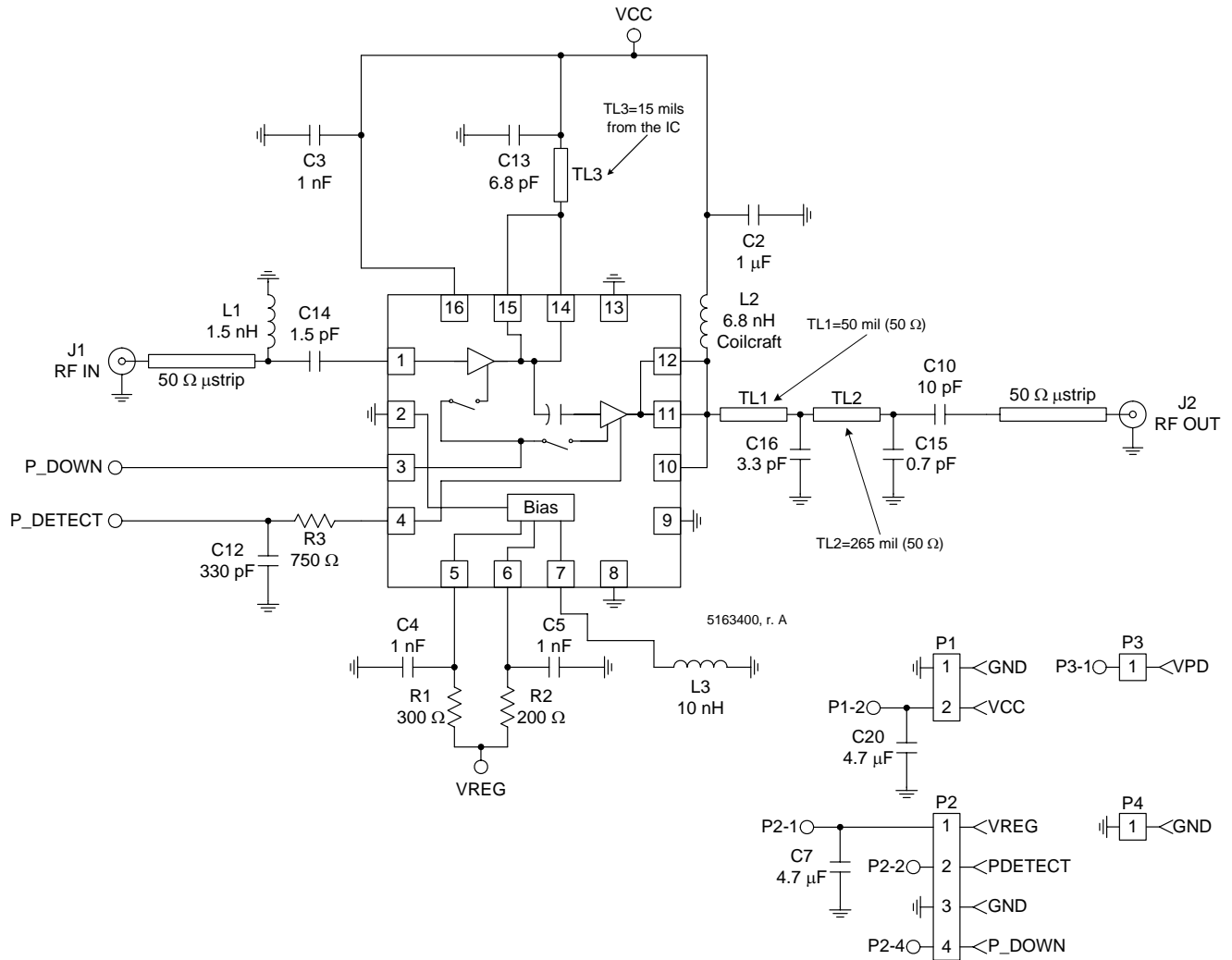

RF5163

Evaluation Board Schematic RF5163PCBA-WD Evaluation Board (2400MHz to 2500MHz)

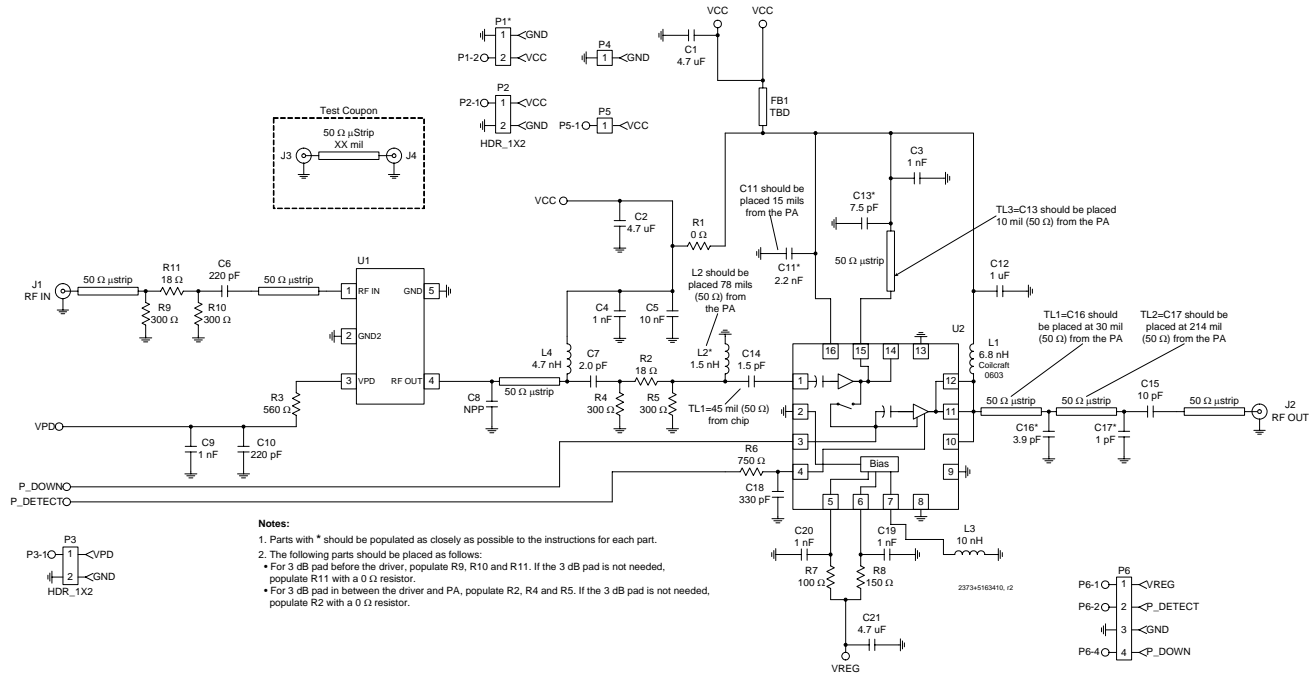

Evaluation Board Layout
RF5163PCBA Evaluation Board (2400MHz to 2500MHz)
Board Size 2.0" x 2.0"

Board Thickness 0.031", Board Material FR-4, Multi-Layer

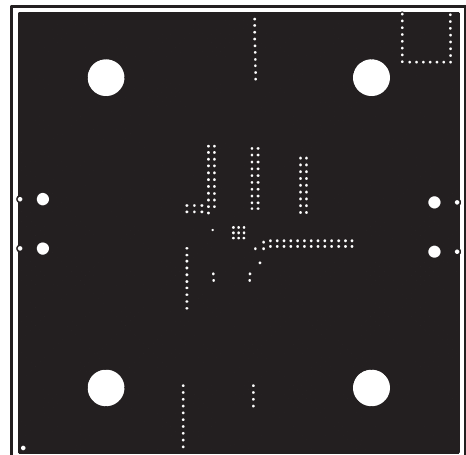
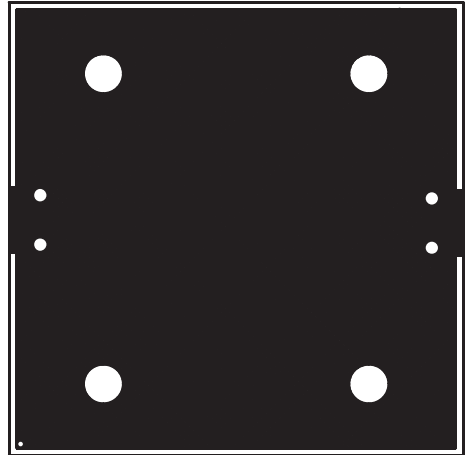
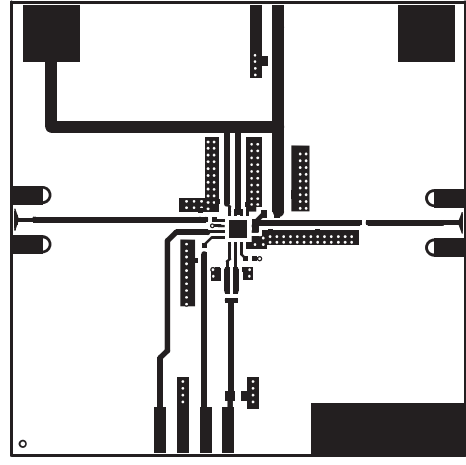
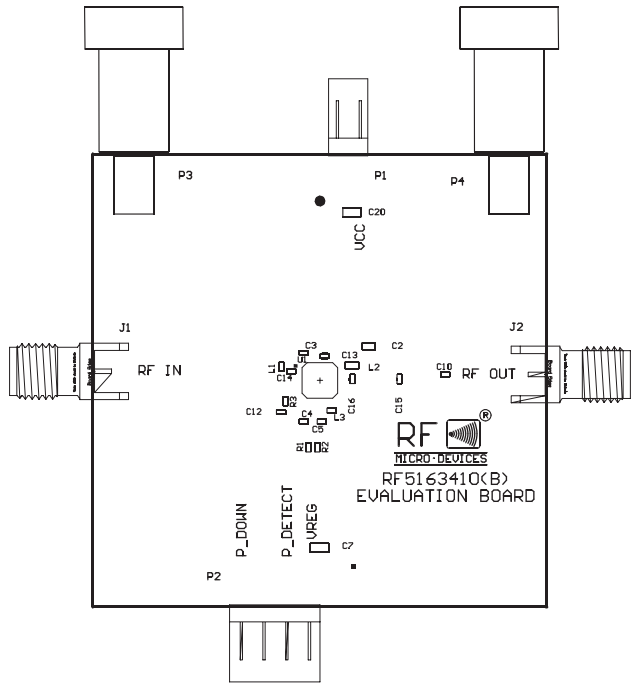

RF5163

Evaluation Board Layout

RF5163PCBA-WD Evaluation Board (2400MHz to 2500MHz)
Board Size 2.0" x 2.0"
Board Thickness 0.031", Board Material FR-4, Multi-Layer

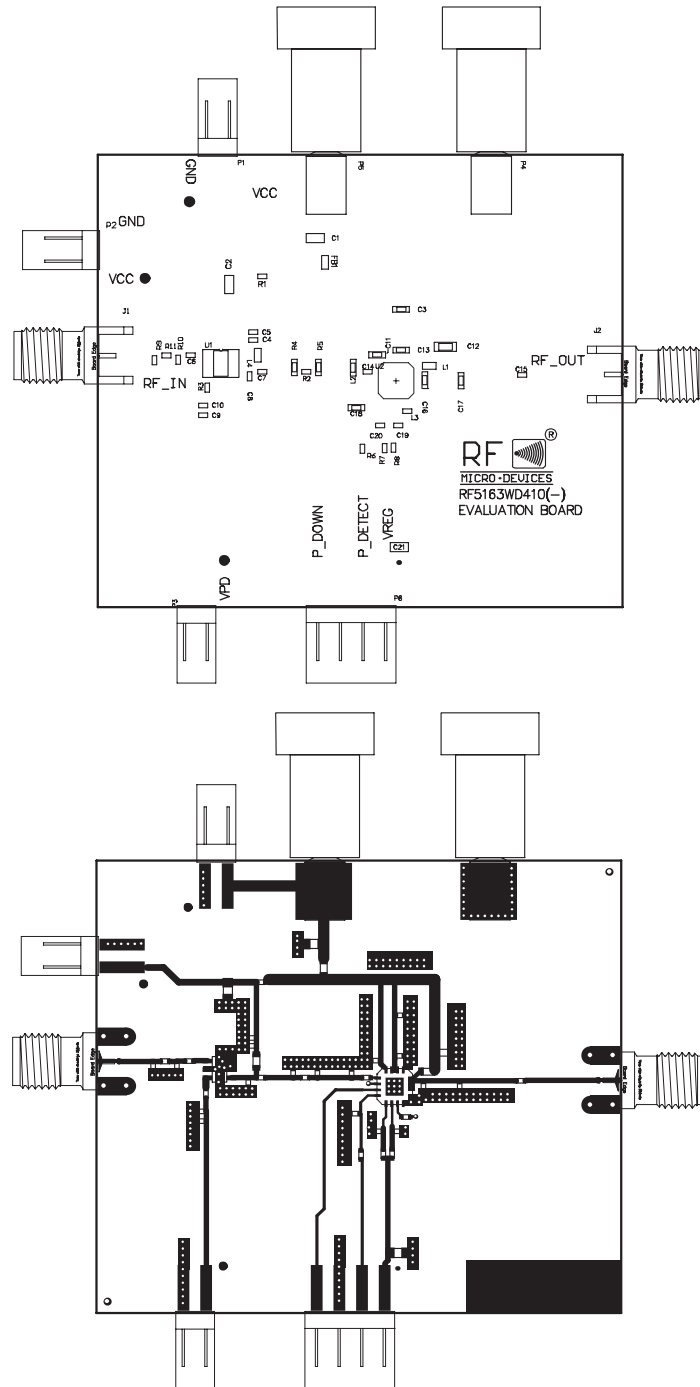

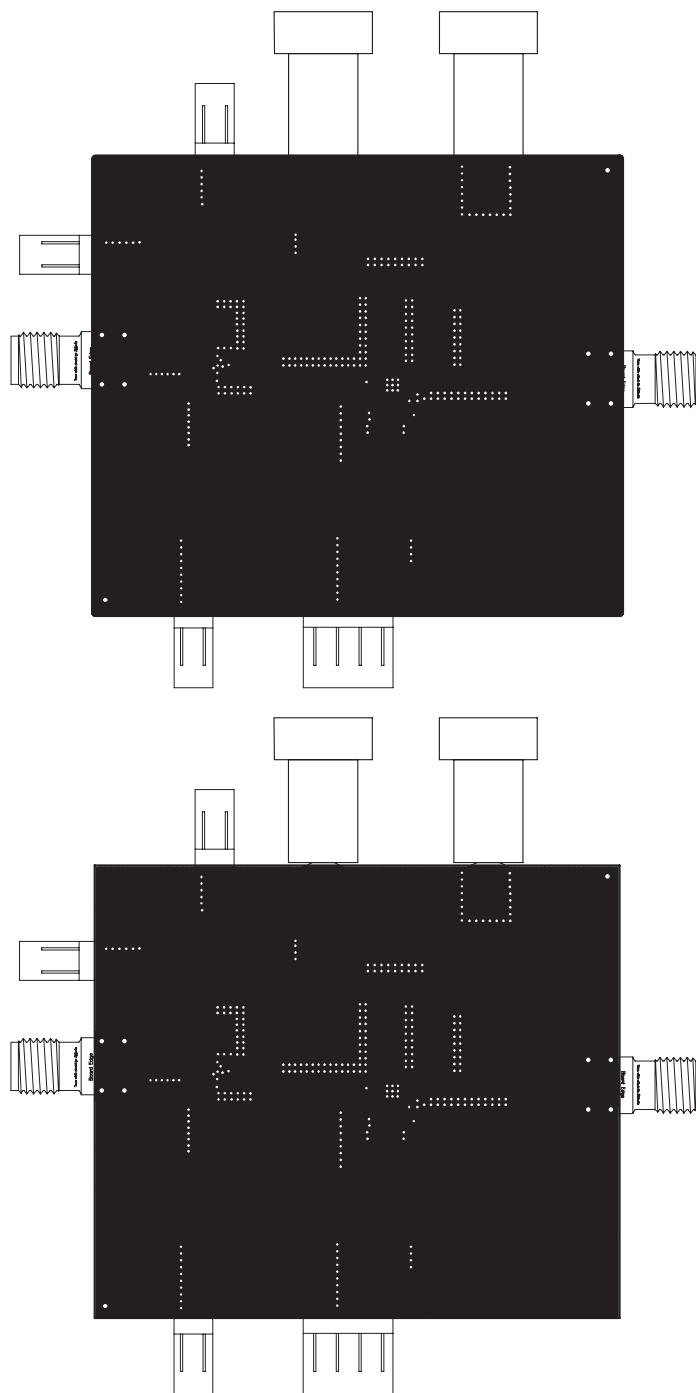

RF5163

Gain and RF P_{OUT} versus Frequency (MHz),

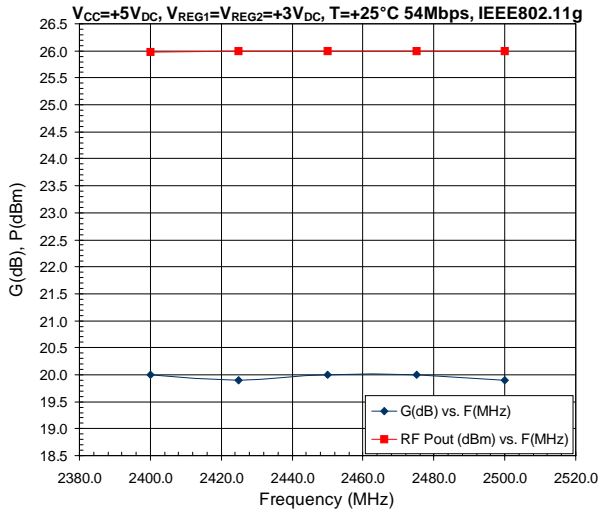

EVM (%) versus Frequency (GHz)

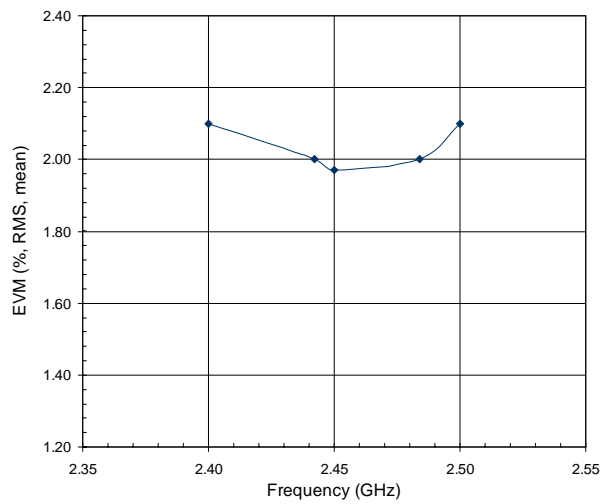

ICC (A) (Total) versus Frequency (GHz)

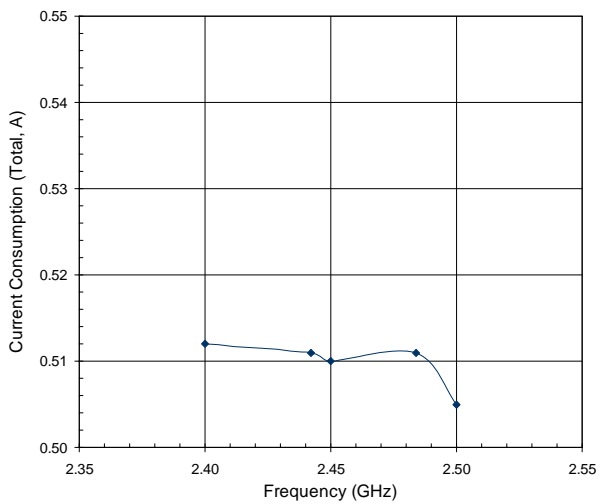

P_{Detect} versus P_{Out},

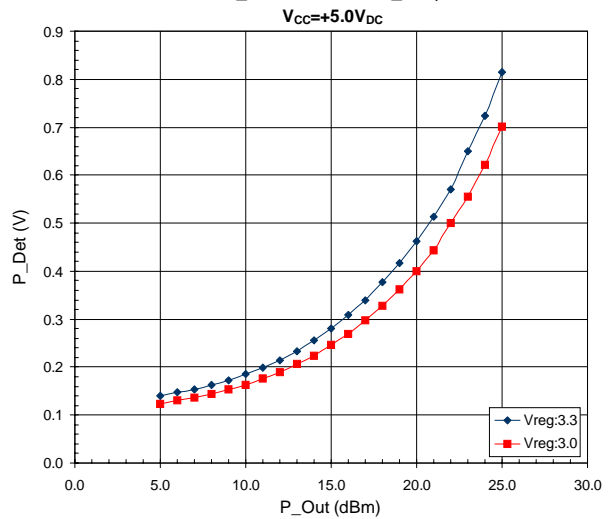

RF P_{OUT} versus EVM and I_{CC} (Total)

