



Package Style: QFN, 16-Pin, 3mmx3mmx0.45mm



Features

- High Gain; 32dB
- 2.5% EVM (RMS) at 24dBm, 3.3V
- 2.5% EVM (RMS) at 26dBm, 5.0V
- Internal Power Detector
- Integrated Input Match

Applications

- WiMAX USB Data Cards
- WiMAX Customer Premises Equipment
- WiMAX Access Points
- IEEE 802.16 WiMAX Systems

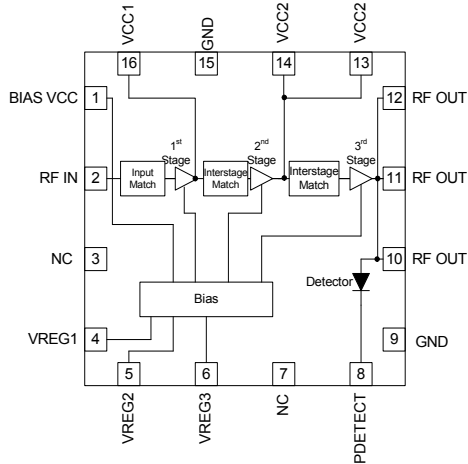

Functional Block Diagram

Product Description

The RF5603 is a linear power amplifier IC designed specifically for WiMAX medium power applications. The device is manufactured on an advanced InGaP Heterojunction Bipolar Transistor (HBT) process, and has been designed for use as the final RF amplifier in 802.16e transmitters. The device is provided in a 3mmx3mmx0.45mm, 16-pin, leadless chip carrier with a backside ground. The RF5603 is designed to maintain linearity over a wide range of conditions and power outputs.

Optimum Technology Matching® Applied

- | | | | |
|---|--------------------------------------|-------------------------------------|-----------------------------------|
| <input type="checkbox"/> GaAs HBT | <input type="checkbox"/> SiGe BiCMOS | <input type="checkbox"/> GaAs pHEMT | <input type="checkbox"/> GaN HEMT |
| <input type="checkbox"/> GaAs MESFET | <input type="checkbox"/> Si BiCMOS | <input type="checkbox"/> Si CMOS | <input type="checkbox"/> RF MEMS |
| <input checked="" type="checkbox"/> InGaP HBT | <input type="checkbox"/> SiGe HBT | <input type="checkbox"/> Si BJT | <input type="checkbox"/> LDMOS |

RF MICRO DEVICES®, RFMD®, Optimum Technology Matching®, Enabling Wireless Connectivity™, PowerStart®, POLARIS™ TOTAL RADIO™ and UltimateBlue™ are trademarks of RFMD, LLC. BLUETOOTH is a trademark owned by Bluetooth SIG, Inc., U.S.A. and licensed for use by RFMD. All other trade names, trademarks and registered trademarks are the property of their respective owners. ©2006, RF Micro Devices, Inc.

Absolute Maximum Ratings

Parameter	Rating	Unit
Supply Voltage (RF Applied)	-0.5 to +5.25	V
Supply Voltage (No RF Applied)	-0.5 to +6.0	V
DC Supply Current	1000	mA
Input RF Power	+10*	dBm
Operating Ambient Temperature	-40 to +85	°C
Storage Temperature	-40 to +150	°C
Moisture Sensitivity	MSL1, 260C rating, 3X reflow	

*Note: Maximum input power with a 50Ω load.



Caution! ESD sensitive device.

Exceeding any one or a combination of the Absolute Maximum Rating conditions may cause permanent damage to the device. Extended application of Absolute Maximum Rating conditions to the device may reduce device reliability. Specified typical performance or functional operation of the device under Absolute Maximum Rating conditions is not implied.

RoHS status based on EUDirective2002/95/EC (at time of this document revision).

The information in this publication is believed to be accurate and reliable. However, no responsibility is assumed by RF Micro Devices, Inc. ("RFMD") for its use, nor for any infringement of patents, or other rights of third parties, resulting from its use. No license is granted by implication or otherwise under any patent or patent rights of RFMD. RFMD reserves the right to change component circuitry, recommended application circuitry and specifications at any time without prior notice.

Parameter	Specification			Unit	Condition
	Min.	Typ.	Max.		
Compliance WiMAX IEEE802.16e					Nominal Condition T=25 °C, V _{CC} =3.3V, V _{REG} =2.85V, Freq=Full frequency range, using a standard IEEE802.16e 16QAM 10MHz BW waveform at 37% duty cycle unless otherwise noted
Frequency Range	3.3		3.6	GHz	
	3.6		3.8	GHz	
Output Power	23	24		dBm	Over temperature -40 °C to +85 °C
EVM		2.5	4	%	At Rated Output Power
Current					
Operating		425	500	mA	At P _{OUT} =24dBm, V _{CC} =3.3V, across V _{REG} 2.75V to 2.95V
Quiescent		250	300	mA	V _{CC} =3.3V, V _{REG} =2.85V, RF=Off
I _{REG}		5	10	mA	Across all conditions
Leakage		0.5	1	uA	V _{CC} =3.3V, V _{REG} =0V, RF=Off
Gain	29	32.5	36	dB	At Rated Output Power, across V _{REG} 2.75V to 2.95V
Gain Variation over Temperature			±2.5	dB	-40 °C to +85 °C
Low Gain Mode (Gain Reduction)		25		dB	At V _{CC} =3.3V, V _{REG} 1 and 3=2.85V, V _{REG} 2=Low and Temp=25 °C (In this mode the gain of the power amplifier drop by TBD typical from its original gain)
Power Detector	10		29	dBm	Useable power detection range
Input Return Loss		-15	-10	dB	
Output P1dB		29		dBm	With CW signal at V _{CC} =3.3V
Turn-On Time from Setting of VREG		0.5	1	μs	Output stable to within 90% of final gain
Compliance WiMAX IEEE802.16e					Nominal Condition T=25 °C, V _{CC} =5.0V, V _{REG} =2.85V, Freq=Full frequency range, using a standard IEEE802.16e 16QAM 10MHz BW waveform at 37% duty cycle unless otherwise noted
Frequency Range	3.3		3.6	GHz	
	3.6		3.8	GHz	
Output Power	24.5	26		dBm	Over temperature -40 °C to +85 °C
EVM		2.5	3.5	%	At Rated Output Power

Parameter	Specification			Unit	Condition
	Min.	Typ.	Max.		
Compliance WiMAX IEEE802.6e, cont.					Nominal Condition T=25 °C, V _{CC} =5.0V, V _{REG} =2.85V, Freq=Full frequency range and duty cycle=37.09% unless otherwise specified.
Current					
Operating		580	700	mA	At P _{OUT} =26dBm, V _{CC} =5.0V, across V _{REG} 2.75V to 2.95V
Quiescent		370	420	mA	V _{CC} =5.0V, V _{REG} =2.85V, RF=Off
I _{REG}		5	10	mA	Across all conditions
Leakage		0.5	1	µA	V _{CC} =5.0V, V _{REG} =0V, RF=Off
Gain	31	34	37	dB	At Rated Output Power, across V _{REG} 2.75V to 2.95V
Gain Variation Over Temperature			±2.5	±dB	-40°C to +85°C
Low Gain Mode (Gain Reduction)		25		dB	At V _{CC} =5.0V, V _{REG} 1 and 3=2.85V, V _{REG2} =Low and Temp=25 °C (In this mode the gain of the power amplifier drops by TBD typical from its original gain)
Power Detector	10		29	dBm	Useable power detection range
Input Return Loss		-15	-10	dB	
Output P1dB		32		dBm	With CW signal at V _{CC} =5.0V
Turn-On Time from Setting of V _{REG}		0.5	1	µs	Output stable to within 90% of final gain
Thermal Data					
Maximum Junction Temperature for long term reliability, T _J Max		150		°C	P _{OUT} =26dBm, V _{CC} =5V _{D_C} , V _{REG} =2.85V _{D_C} , T _{REF} = 85 °C
Thermal Resistance, Q _{JC}		23.7		°C/W	P _{OUT} =26dBm, V _{CC} =5V _{D_C} , V _{REG} =2.85V _{D_C} , Junction to bottom of QFN package. T _{REF} = 85 °C
Thermal Resistance, Q _{J-Ref}		29.7		°C/W	P _{OUT} =26dBm, V _{CC} =5V _{D_C} , V _{REG} =2.85V _{D_C} , Junction to bottom of PCB. T _{REF} = 85 °C
Human Body Model			500	V	P _{OUT} =26dBm, V _{CC} =5V _{D_C} , V _{REG} =2.85V _{D_C} , Junction to bottom of PCB. T _{REF} = 85 °C
Charge Device Model			1000	V	P _{OUT} =26dBm, V _{CC} =5V _{D_C} , V _{REG} =2.85V _{D_C} , Junction to bottom of PCB. T _{REF} = 85 °C

Pin	Function	Description
1	BIAS VCC	Supply voltage for the bias reference and control circuits. May be connected with VCC1 and VCC2 as long as V_{CC} does not exceed $5.0V_{DC}$ in this configuration.
2	RF IN	RF input, internally matched and DC block is provided.
3, 7, 9, 15	NC	Not connected. May be connected to ground.
4	VREG1	First stage input bias voltage. This pin requires a regulated supply to maintain nominal bias current.
5	VREG2	Second stage input bias voltage. This pin requires a regulated supply to maintain nominal bias current.
6	VREG3	Third stage input bias voltage. This pin requires a regulated supply to maintain nominal bias current.
8	P DETECT	Power detector provides an output voltage proportional to the RF output power level.
10, 11, 12	VCC3/ RF OUT	RF output and bias for the output stage. Output is externally matched to 50Ω and needs DC block.
13, 14	VCC2	Second stage supply voltage.
16	VCC1	First stage supply voltage.
Pkg Base	GND	Ground connection. The back side of the package should be connected to the ground plane through as short a connection as possible, e.g., PCB vias under the device are recommended.

Package Outline

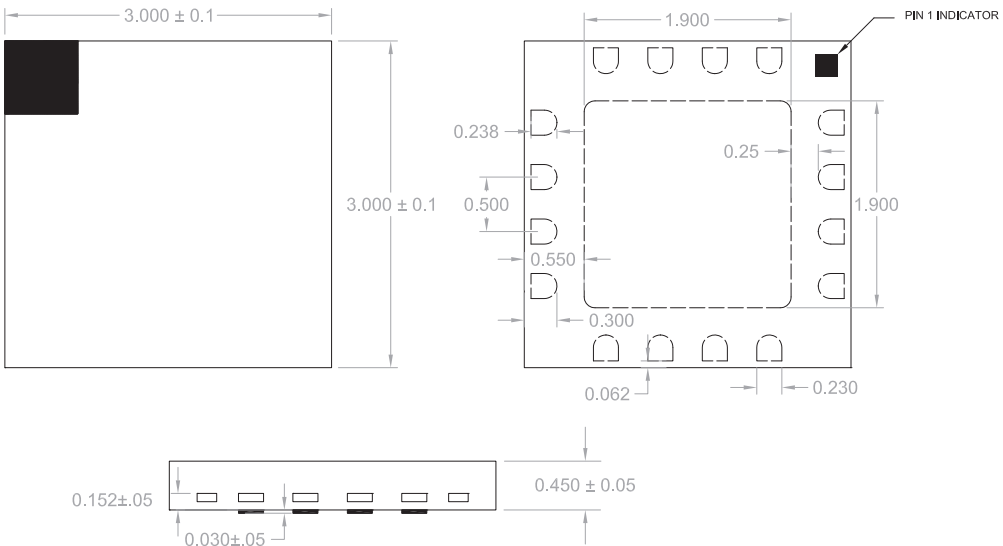

NOTES:

- 1 Shaded Area is Pin 1 Indicator

PCB Design Requirements

PCB Surface Finish

The PCB surface finish used for RFMD's qualification process is electroless nickel, immersion gold. Typical thickness is 3µinch to 8µinch gold over 180µinch nickel.

PCB Land Pattern Recommendation

PCB land patterns for RFMD components are based on IPC-7351 standards and RFMD empirical data. The pad pattern shown has been developed and tested for optimized assembly at RFMD. The PCB land pattern has been developed to accommodate lead and package tolerances. Since surface mount processes vary from company to company, careful process development is recommended.

PCB Metal Land and Solder Mask Pattern

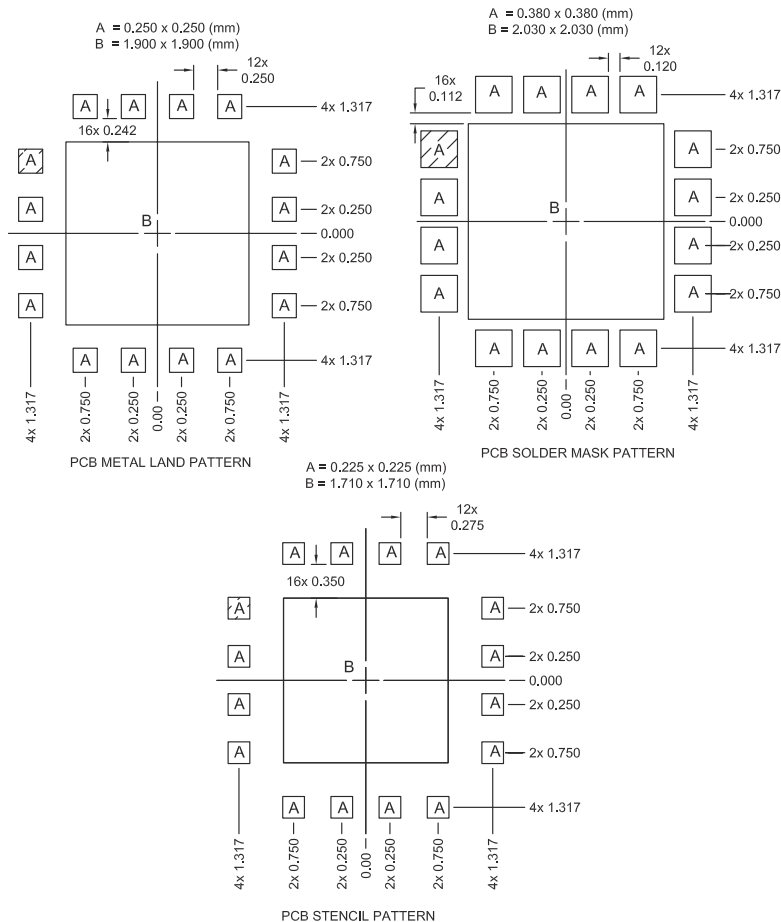

Shaded are represents Pin 1 location.

Thermal vias for center slug “B” should be incorporated into the PCB design. The number and size of thermal vias will depend on the application, the power dissipation, and the electrical requirements. Example of the number and size of vias can be found on the RFMD evaluation board layout.

PCB Metal Land and Solder Mask Pattern

Note: If it is desired to build the same PCB to accommodate the RF5602 as well as the RF5623/RF5603 use the following PCB Patterns.

A = 0.280 x 0.450 (mm) Typ
 B = 0.450 x 0.280 (mm) Typ
 C = 1.800 (mm) Sq

A = 0.390 x 0.560 (mm) Typ
 B = 0.560 x 0.390 (mm) Typ
 C = 1.900 (mm) Sq

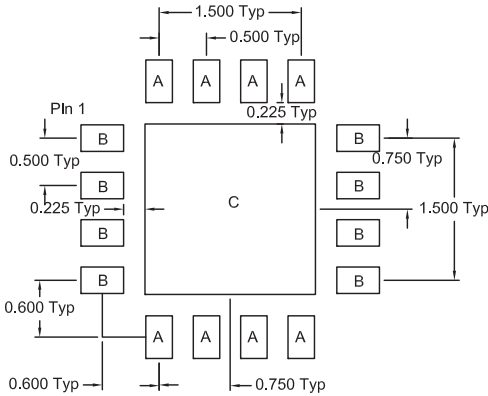

PCB METAL LAND PATTERN

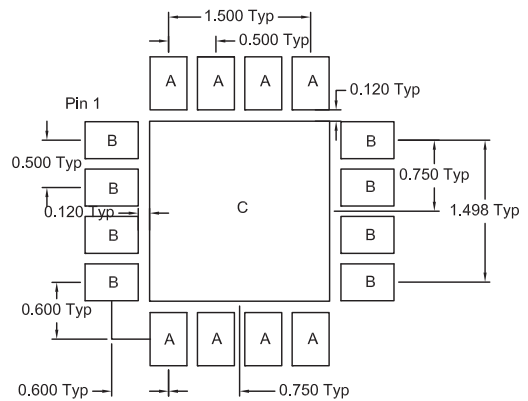

PCB SOLDER MASK PATTERN

A = 0.252 x 0.405 (mm) Typ
 B = 0.405 x 0.252 (mm) Typ
 C = 1.620 (mm) Sq

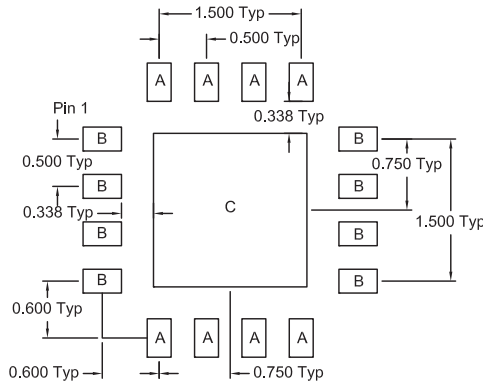

PCB STENCIL PATTERN

Note: Thermal vias for center slug "C" should be incorporated into the PCB design. The number and size of thermal vias will depend on the application. Example of the number and size of vias can be found on the RFMD evaluation board layout.

Pin Out

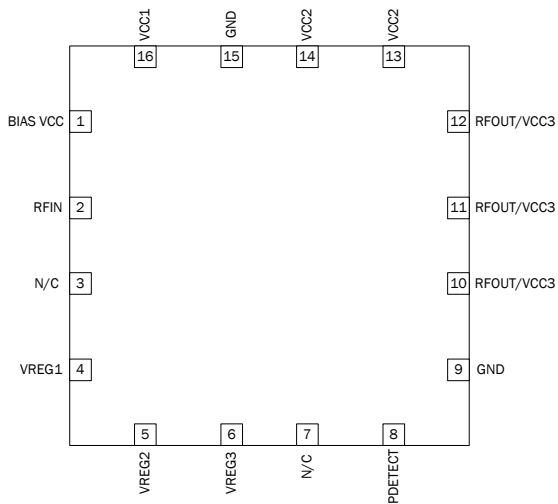

3.3GHz to 3.6GHz Schematic

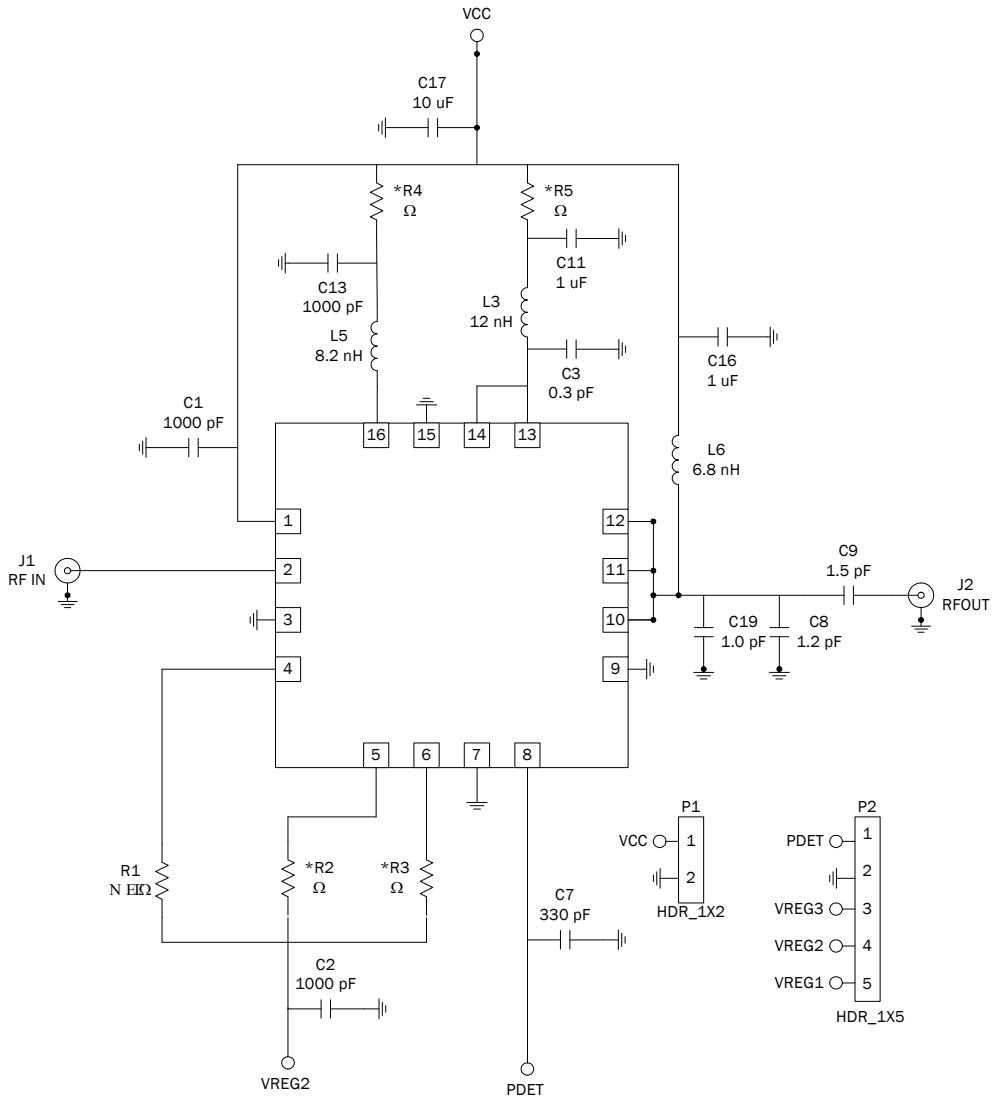

* VCC(V)	R1(Ohms)	R2(Ohms)	R3(Ohms)	R4(Ohms)	R5(Ohms)
3.3	220	180	56	0	0
5.0	220	75	0	56	5.1

3.6GHz to 3.8GHz Schematic

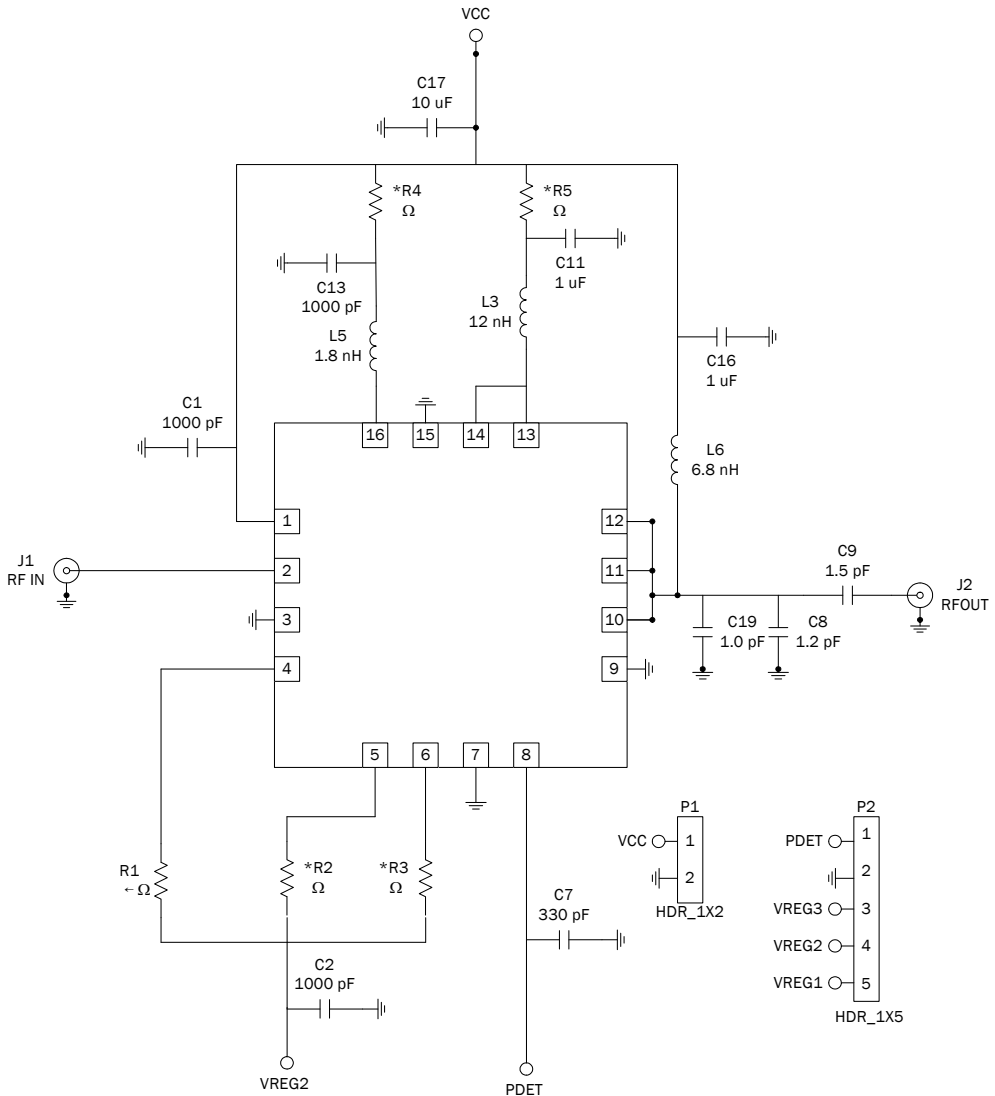

*

VCC(V)	R1(Ohms)	R2(Ohms)	R3(Ohms)	R4(Ohms)	R5(Ohms)
3.3	220	180	56	0	0
5.0	220	75	0	56	5.1

Evaluation Board Layout

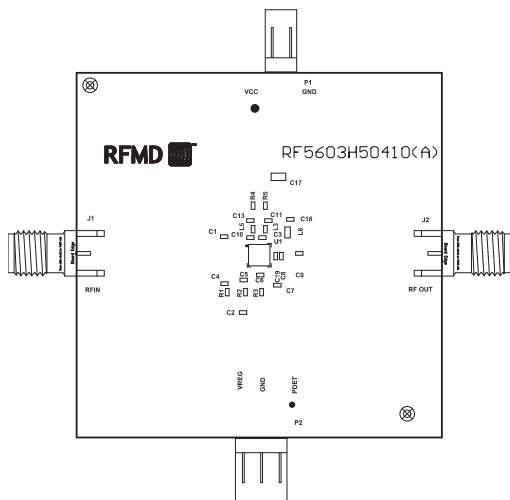

Assembly

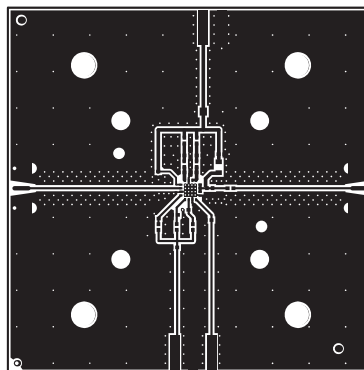

Top

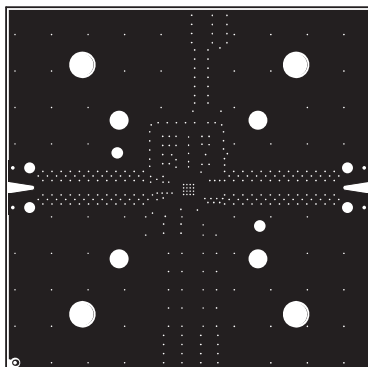

Inner 1

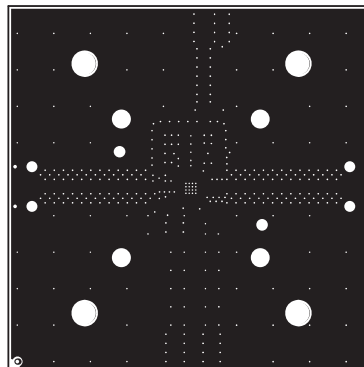

Inner 2

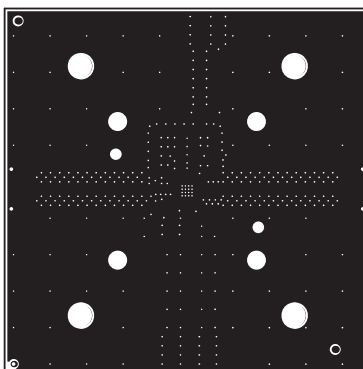

Back

Evaluation Board Layout

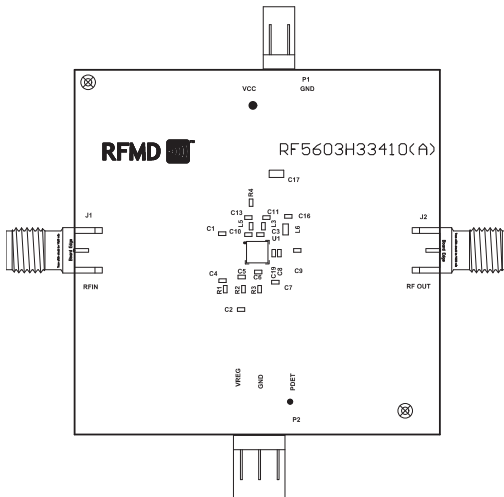

Assembly

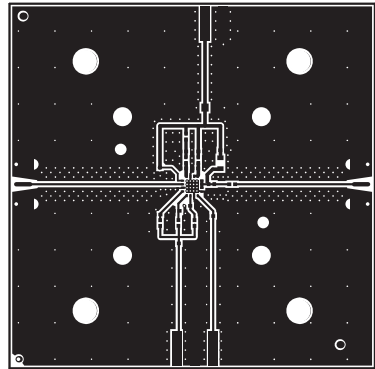

Top

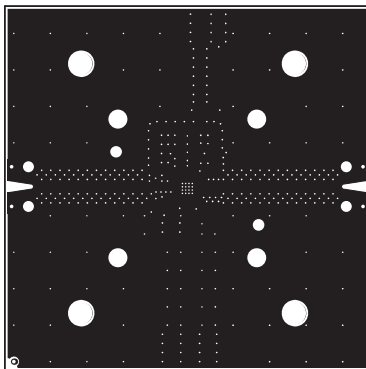

Inner 1

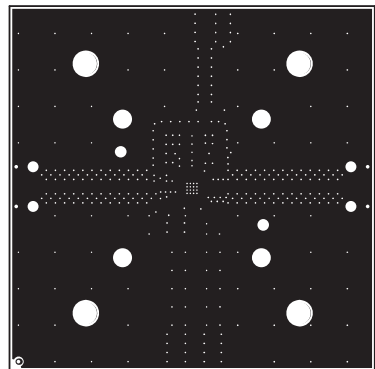

Inner 2

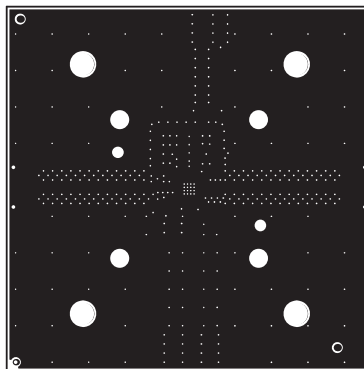

Back

Evaluation Board Layout

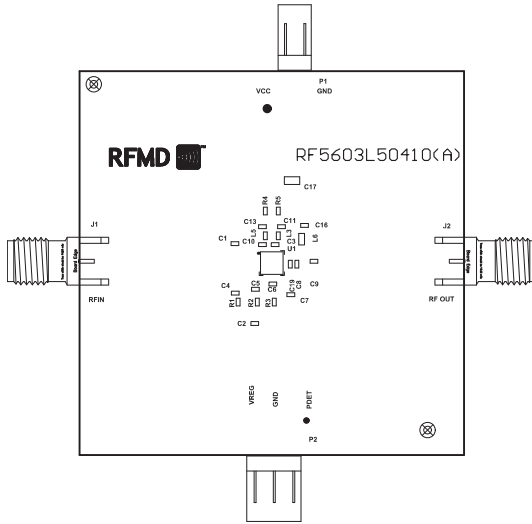

Assembly

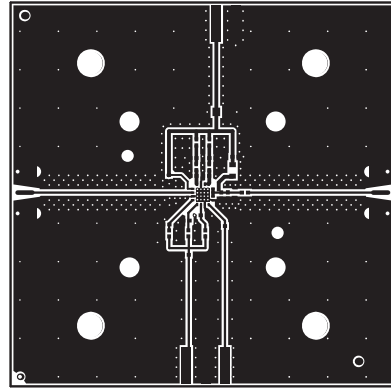

Top

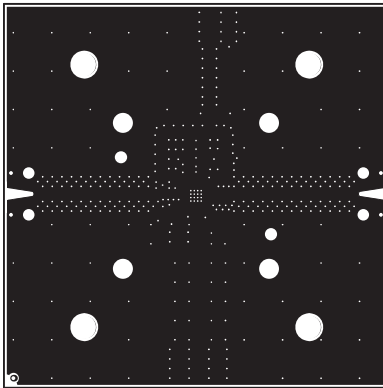

Inner 1

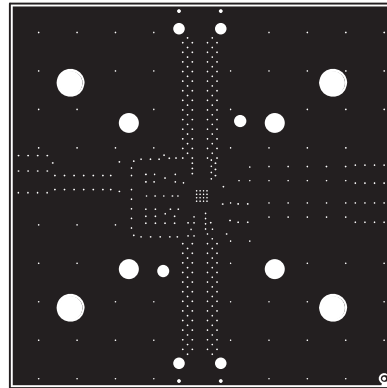

Inner 2

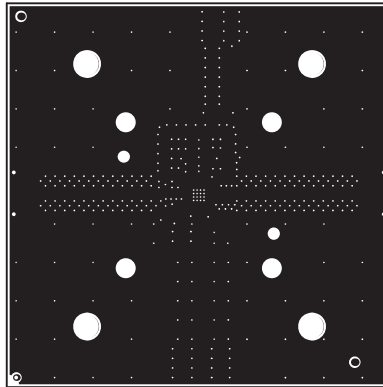

Back

Evaluation Board Layout

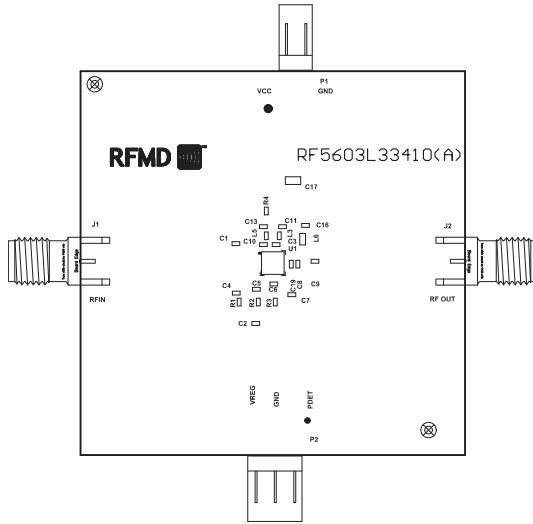

Assembly

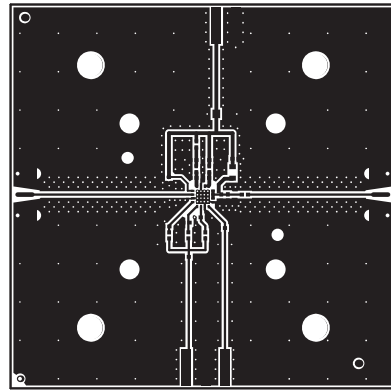

Top

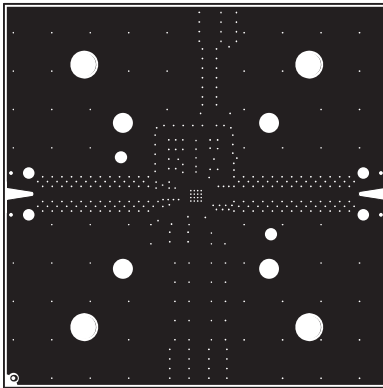

Inner 1

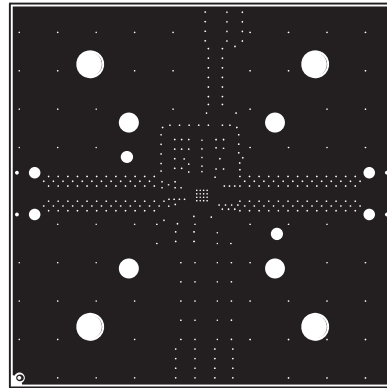

Inner 2

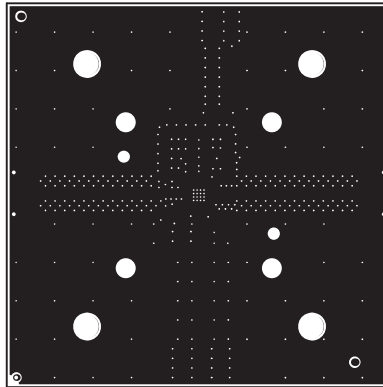

Back

3.3GHz to 3.6GHz

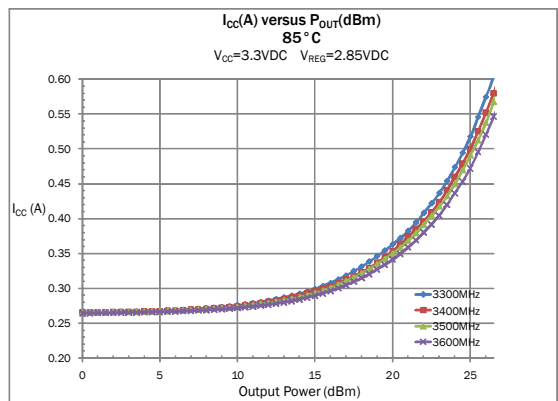
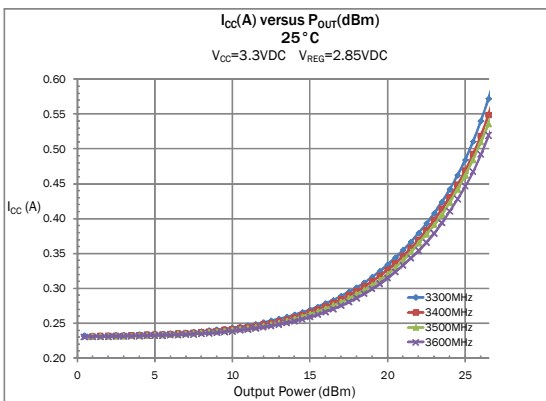
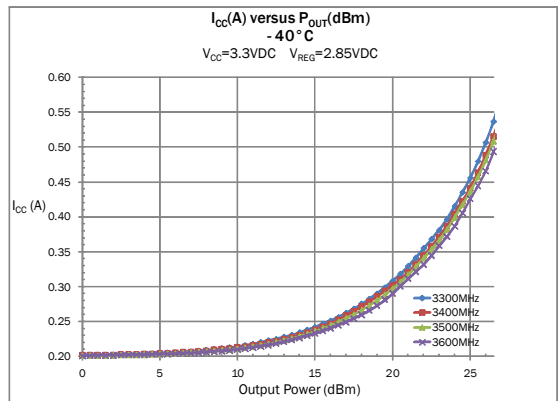
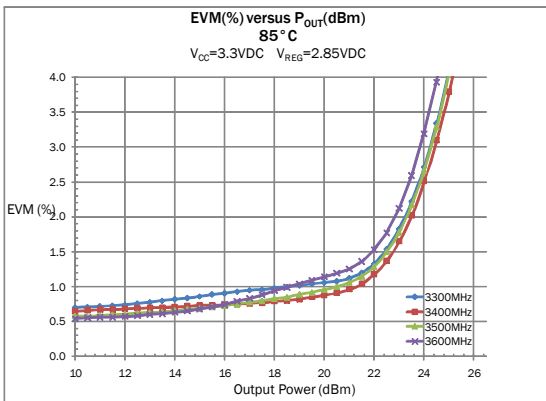
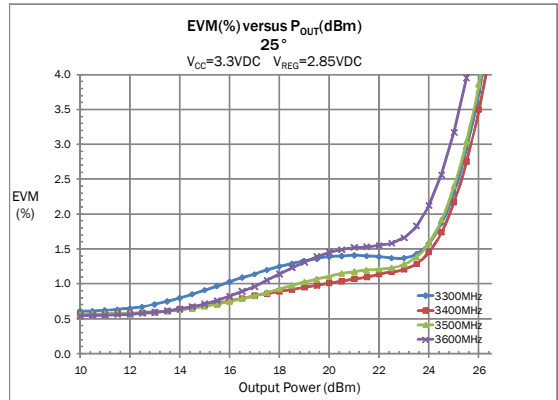
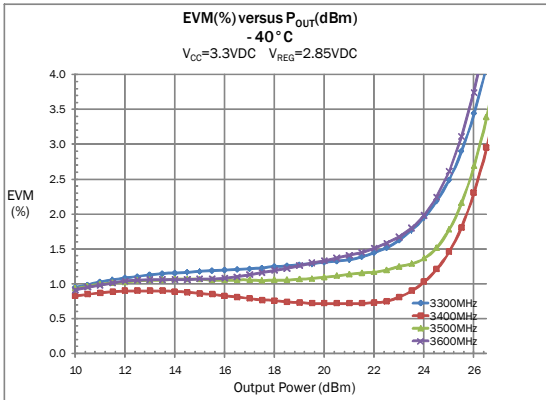

3.3 GHz to 3.6 GHz

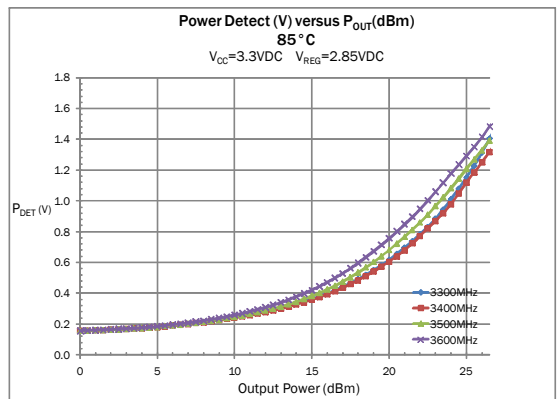
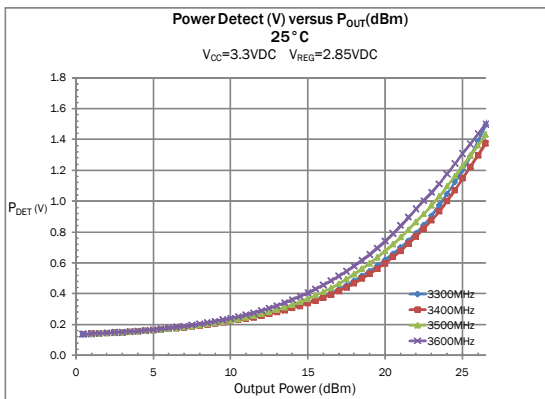
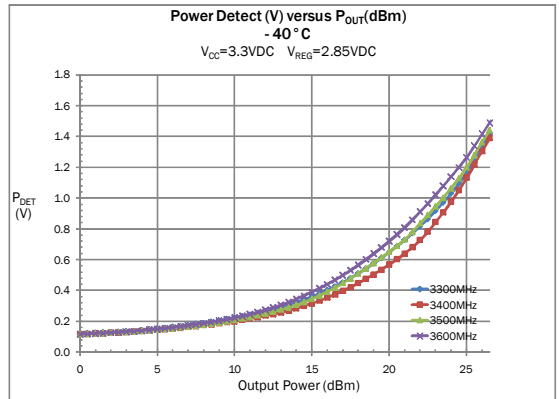
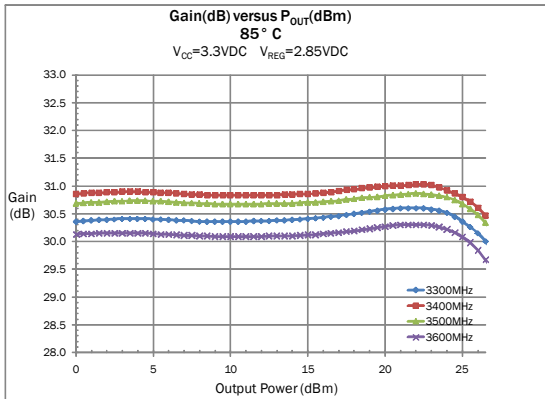
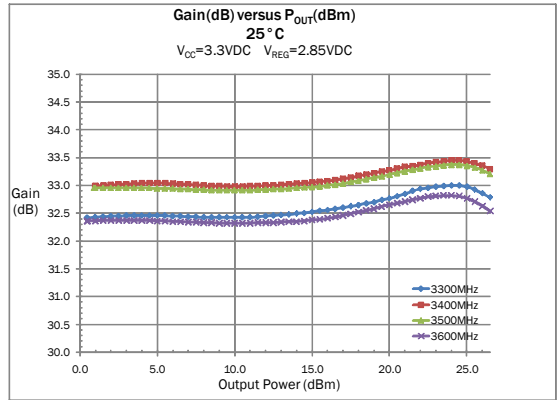
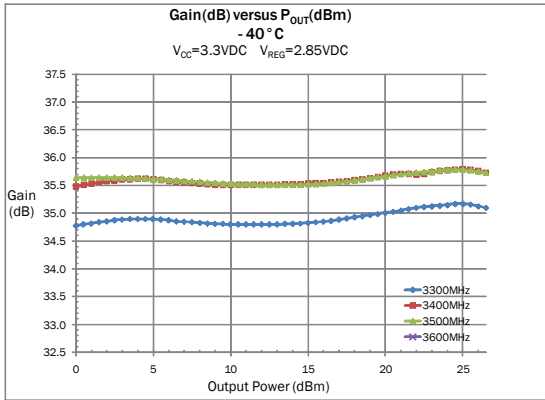

3.3GHz to 3.6GHz

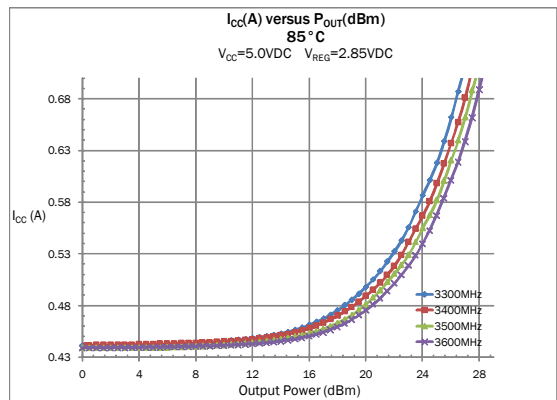
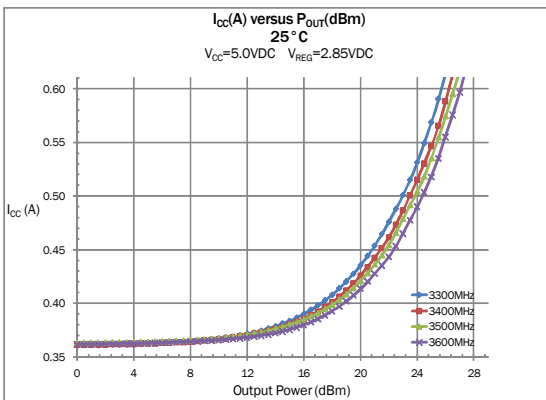
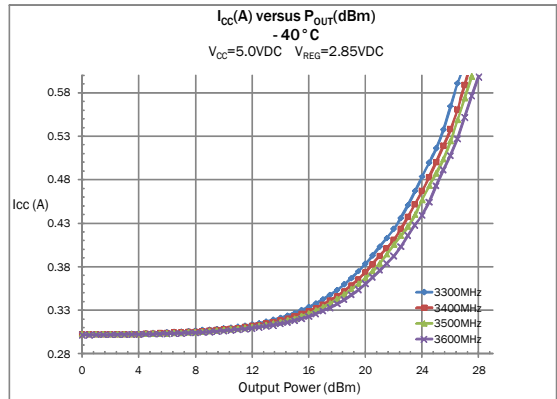
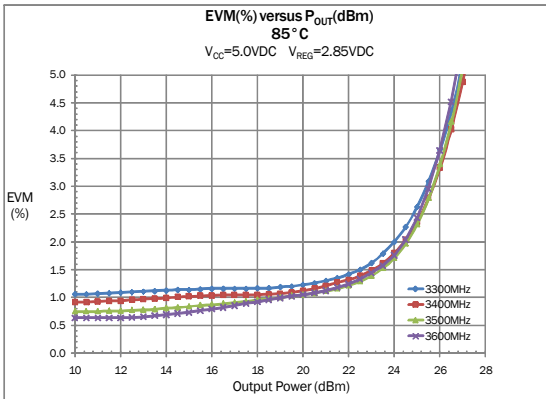
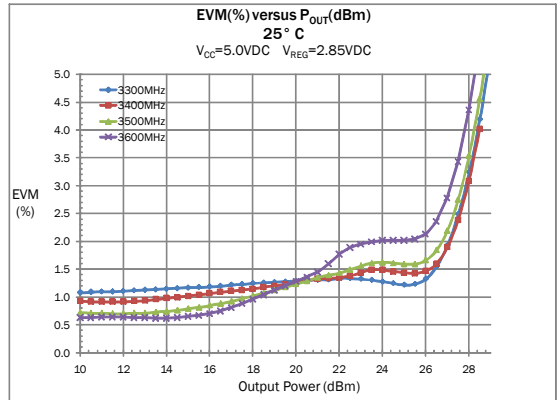
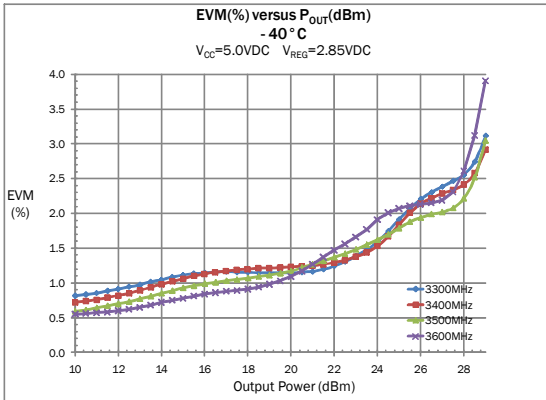

3.3 GHz to 3.6 GHz

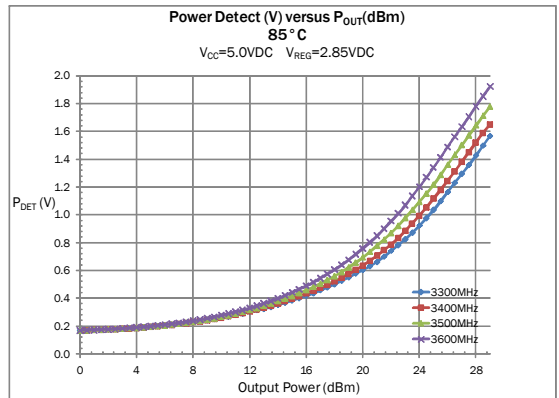
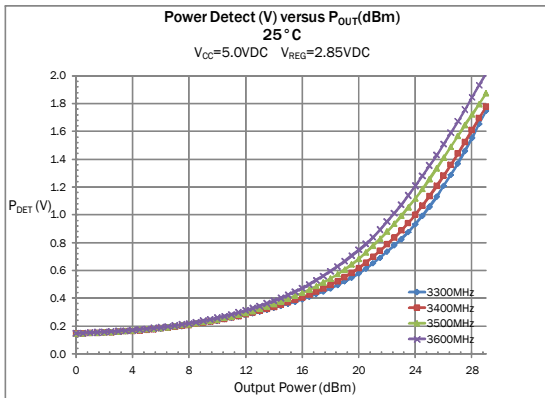
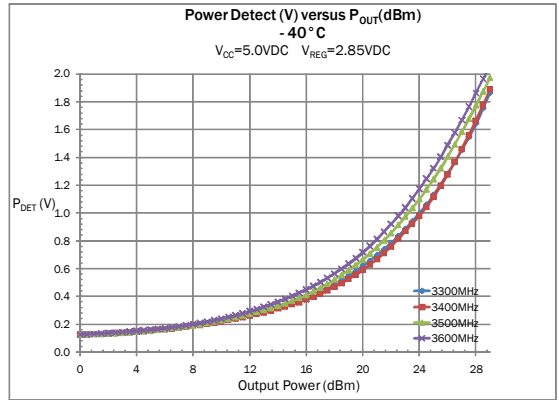
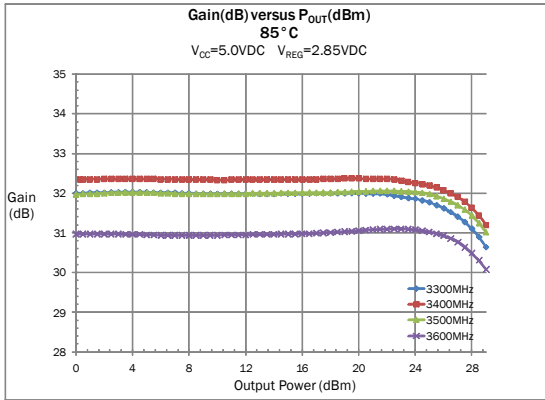
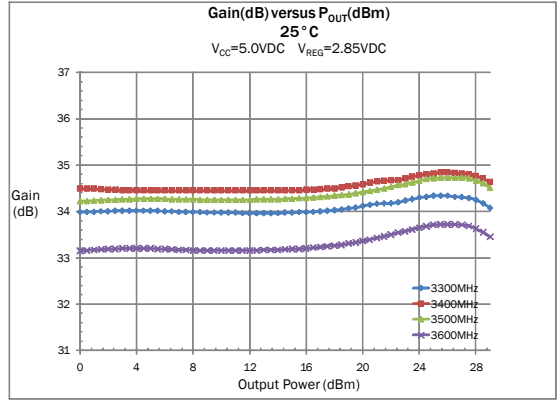
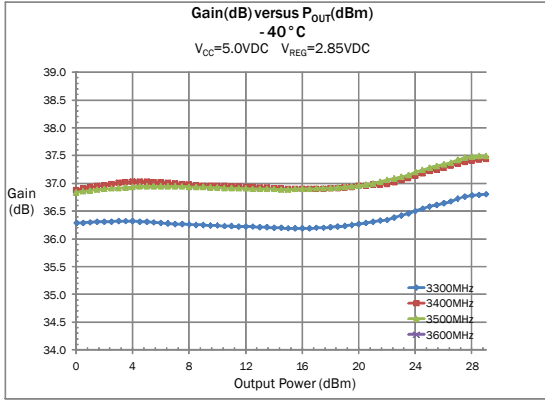

3.6GHz to 3.8GHz

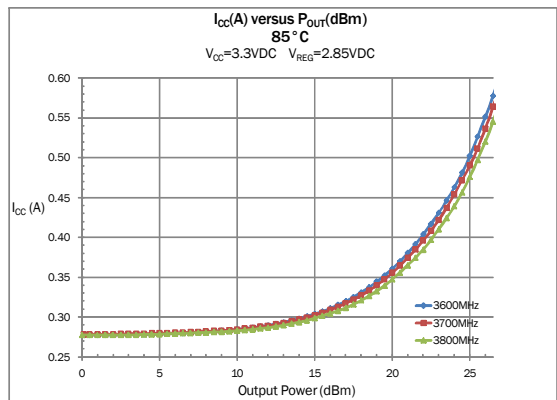
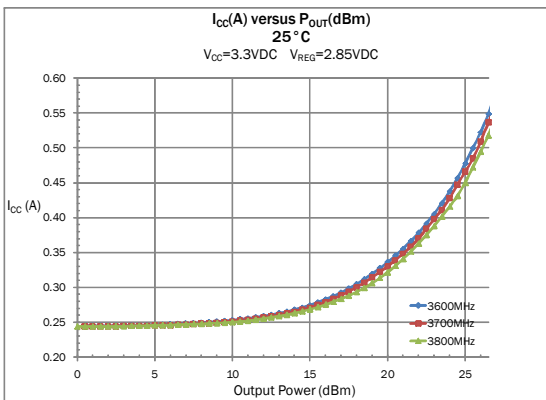
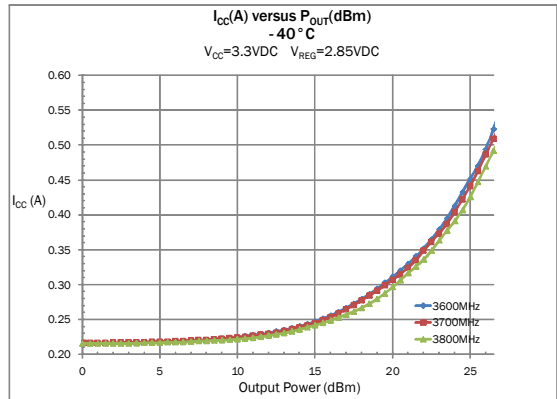
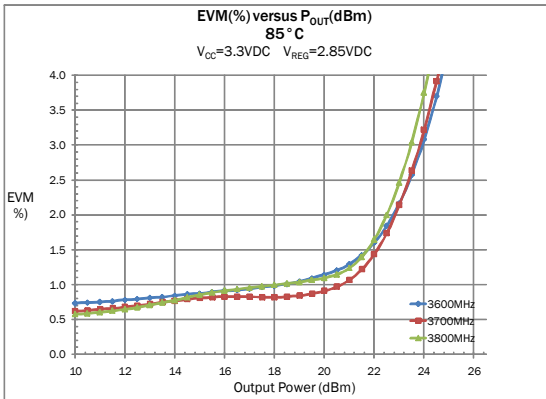
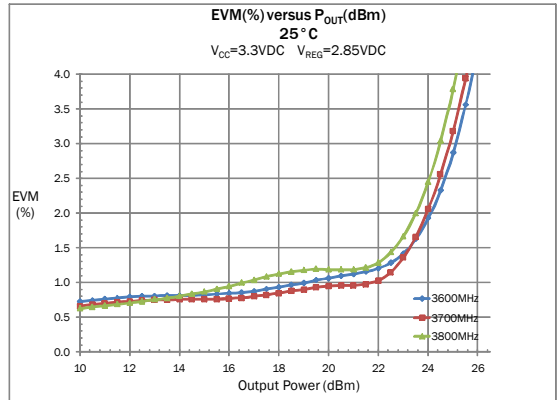
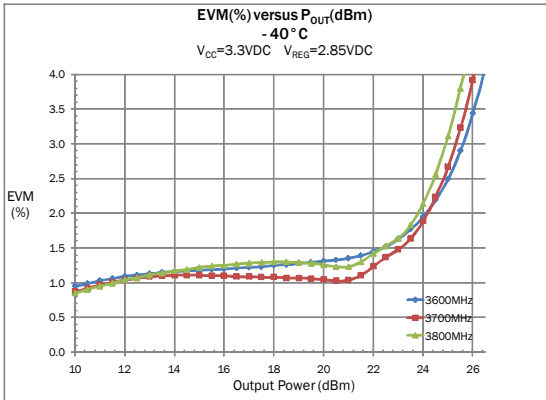

3.6GHz to 3.8GHz

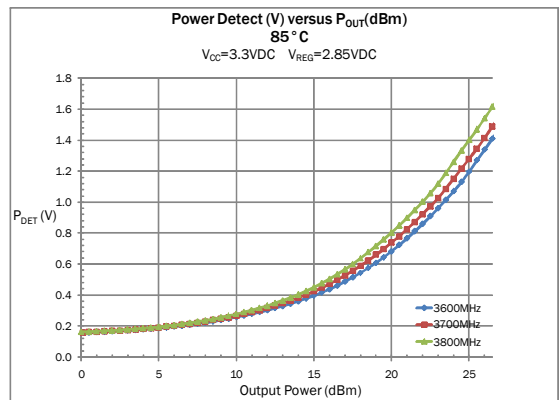
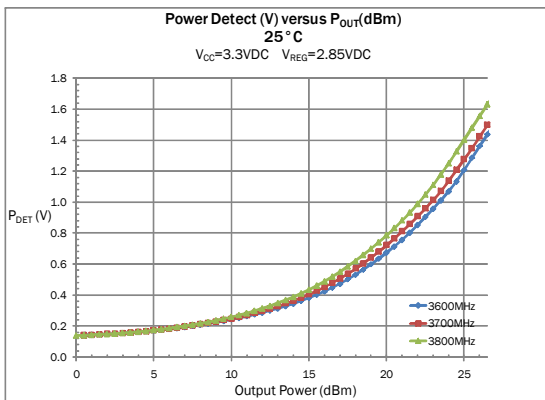
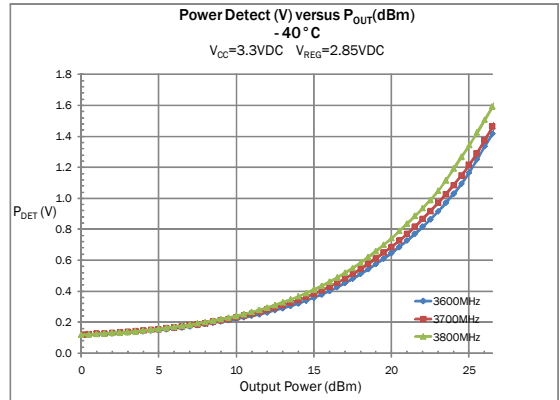
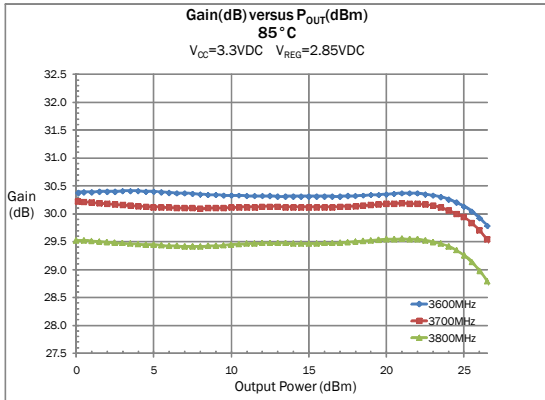
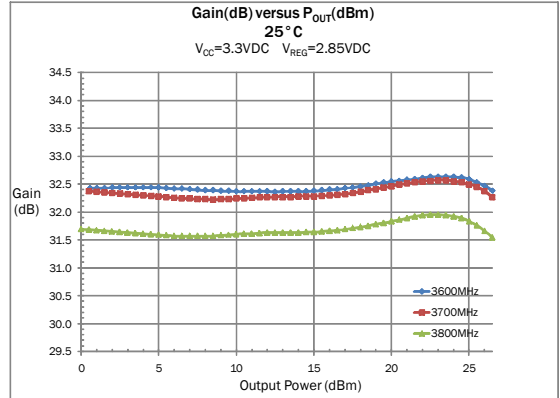
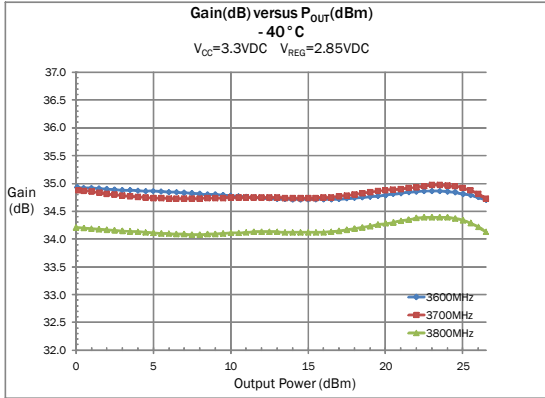

3.6GHz to 3.8GHz

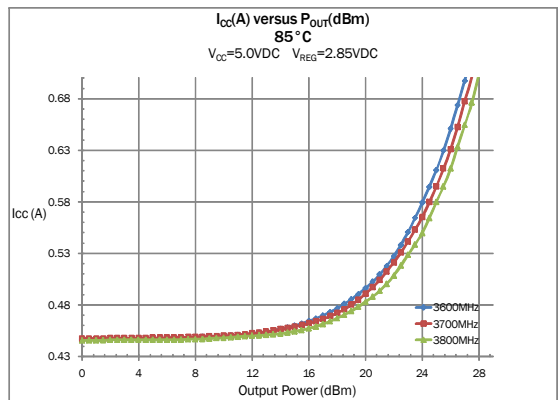
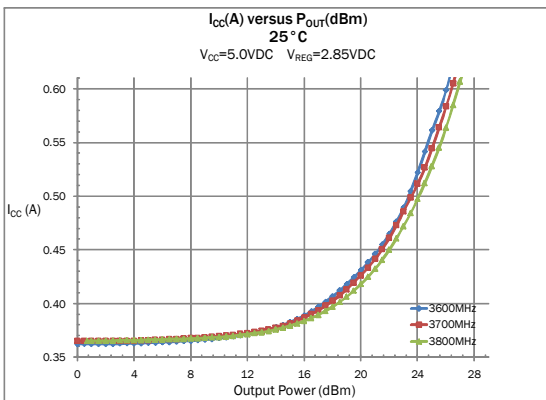
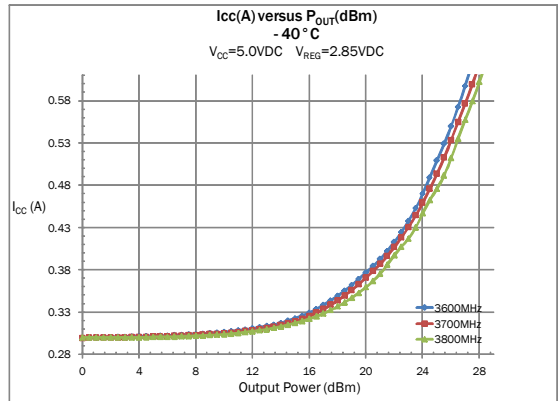
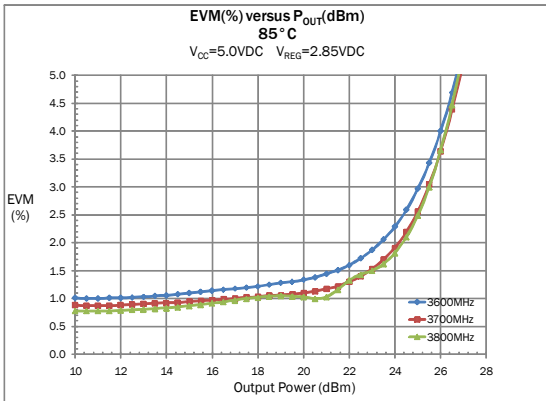
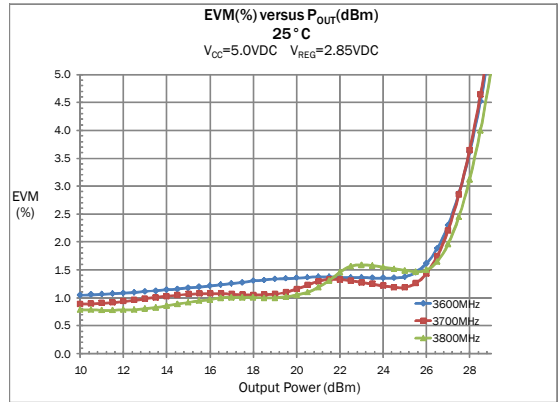
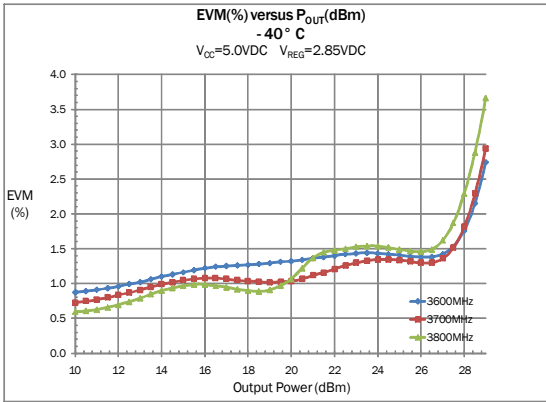

3.6GHz to 3.8GHz

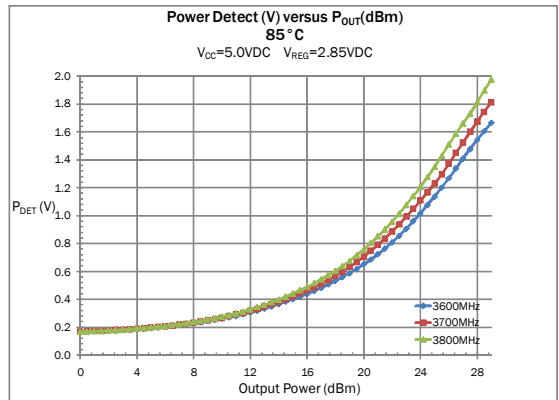
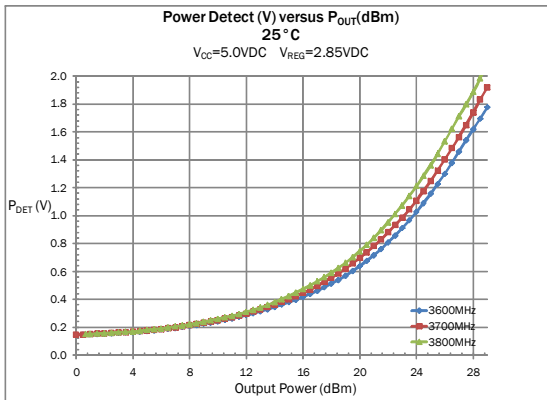
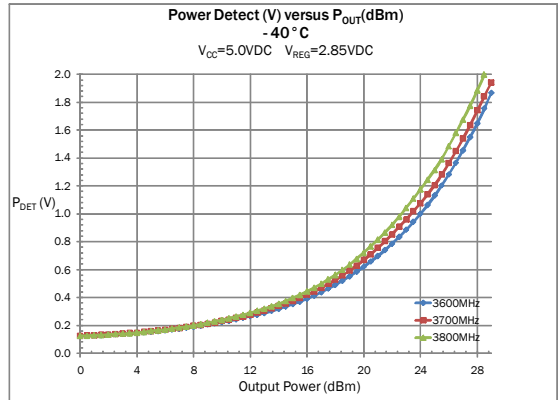
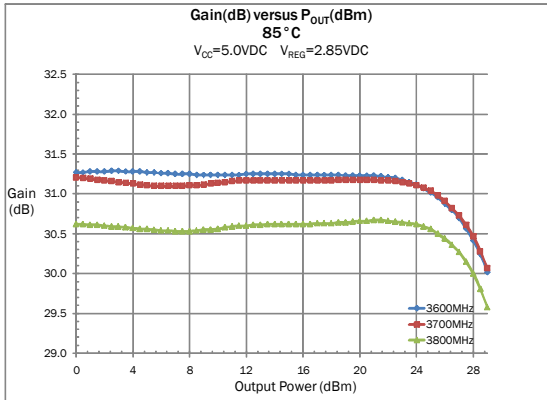
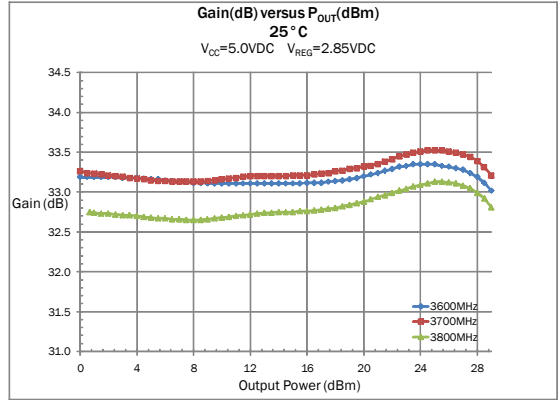
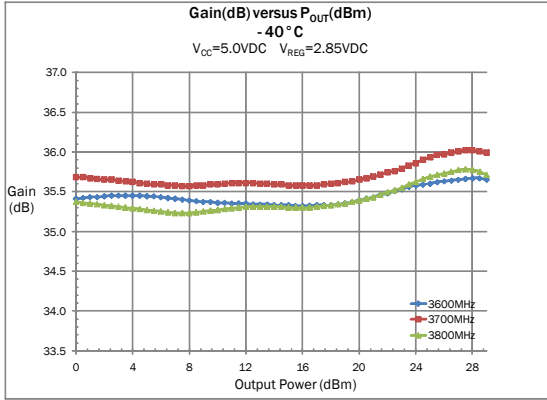

Ordering Information

Ordering Code	Description
RF5603SQ	Standard 25 piece bag
RF5603SR	Standard 100 piece reel
RF5603TR7	Standard 2500 piece reel
RF5603L33PCK-410	3.3GHz to 3.6GHz WiMAX Fully Assembled PCB at 3.3V
RF5603H33PCK-410	3.6GHz to 3.8GHz WiMAX Fully Assembled PCB at 3.3V
RF5603L50PCK-410	3.3GHz to 3.6GHz WiMAX Fully Assembled PCB at 5.0V
RF5603H50PCK-410	3.6GHz to 3.8GHz WiMAX Fully Assembled PCB at 5.0V