



Features

- High Gain = 34dB
- $P_{OUT} = 30\text{dBm} < 3\% \text{ EVM}$
- 2.4GHz to 2.7GHz Frequency Range
- Integrated 3-stage PA
- Integrated Power Detector

Applications

- WiFi IEEE802.11b/g/n Applications
- Picocell, Femtocell
- Customer Premises Equipment (CPE)
- WiMAX IEEE802.16e
- Spread-Spectrum and MMDS Systems
- LTE

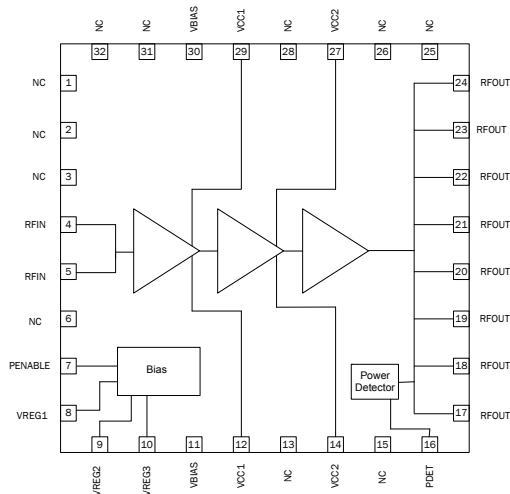

Functional Block Diagram

Product Description

The RF5652 is a High Power Amplifier that is intently specified to address IEEE 802.11b/g/n WiFi 2.4GHz to 2.5GHz customer premises equipment (CPE) applications; and WiMAX (2.5GHz to 2.7GHz) CPE applications. The PA has an intergrated 3-stage Linear Power Amplier, with 30dBm (1 Watt) linear power at PA output. This product will be housed in an 5mmx5mm QFN.

Ordering Information

RF5652	Standard 25 piece bag
RF5652SB	Standard 5 piece bag
RF5652SR	Standard 100 piece reel
RF5652TR13	Standard 2500 piece reel
RF5652PCK-410	Evaluation Board 2.4GHz to 2.5GHz with 5 piece bag
RF5652PCK-411	Evaluation Board 2.5GHz to 2.7GHz with 5 piece bag

Optimum Technology Matching® Applied

- | | | | |
|---|--------------------------------------|-------------------------------------|-----------------------------------|
| <input type="checkbox"/> GaAs HBT | <input type="checkbox"/> SiGe BiCMOS | <input type="checkbox"/> GaAs pHEMT | <input type="checkbox"/> GaN HEMT |
| <input type="checkbox"/> GaAs MESFET | <input type="checkbox"/> Si BiCMOS | <input type="checkbox"/> Si CMOS | <input type="checkbox"/> RF MEMS |
| <input checked="" type="checkbox"/> InGaP HBT | <input type="checkbox"/> SiGe HBT | <input type="checkbox"/> Si BJT | <input type="checkbox"/> LDMOS |

Absolute Maximum Ratings

Parameter	Rating	Unit
Supply Voltage (RF Applied)	-0.5 to +5.25	V
Supply Voltage (No RF Applied)	-0.5 to +6.0	V
DC Supply Current	2000	mA
Input RF Power	+10*	dBm
Operating Ambient Temperature	-40 to +85	°C
Storage Temperature	-40 to +150	°C
Moisture Sensitivity	MSL2	

*Maximum Input Power with a 50Ω load.



Caution! ESD sensitive device.

Exceeding any one or a combination of the Absolute Maximum Rating conditions may cause permanent damage to the device. Extended application of Absolute Maximum Rating conditions to the device may reduce device reliability. Specified typical performance or functional operation of the device under Absolute Maximum Rating conditions is not implied.

RoHS status based on EUDirective2002/95/EC (at time of this document revision).

The information in this publication is believed to be accurate and reliable. However, no responsibility is assumed by RF Micro Devices, Inc. ("RFMD") for its use, nor for any infringement of patents, or other rights of third parties, resulting from its use. No license is granted by implication or otherwise under any patent or patent rights of RFMD. RFMD reserves the right to change component circuitry, recommended application circuitry and specifications at any time without prior notice.

Parameter	Specification			Unit	Condition
	Min.	Typ.	Max.		
Operating Conditions					T=25 °C, V _{CC} =5.0V, V _{REG} =2.85V, using an IEEE802.11g waveform, 54Mbps, unless otherwise noted
Frequency	2412		2484	MHz	Compliance with standard 802.11b and 802.11g
802.11g & 11n Output Power	29	30		dBm	
EVM		2.5	3	%	
Gain	31.5	33.5	37.5	dB	
Gain variation over Temp			+/-2.5	dB	
Second Harmonic		-25		dBm/MHz	
Third Harmonic		-50		dBm/MHz	
Power Detect Range	0.2		2.8	V	P _{OUT} = 0 to 30dBm, usable range from 0 to 32dBm
Power Detect Power Range	10		33	dBm	
Input Return Loss - Tx _{in} pin	10	15		dB	In specified frequency band
Output Return Loss	8	10		dB	In specified frequency band
Operating Current		1450	1650	mA	At P _{OUT} = 30dBm
Quiescent Current		950	1050	mA	V _{CC} = 5.0, V _{REG} = 2.85V & RF=OFF
I _{REG}		13	18	mA	
P _{DOWN} Current			30	mA	P _{DOWN} = 0V, V _{REG} = 2.85V, V _{CC} = 5V
Leakage Current		0.25	0.4	mA	V _{CC} = 5V, V _{REG} = 0V, P _{DOWN} = 0V
Power Supply - V _{CC}		5	5.25	V	
Power supply - V _{REG} (at Eval Board pin)	2.8	2.85	3	V	
Generic Performance					
Turn-on time from setting of V _{REG} 's		650		nsec	Output stable to within 90% of final gain
Stability	-25		34	dBm	No spurs above -47dBm into 4:1 VSWR
Max Pin (Ruggedness - 10:1 VSWR at Ant)			6	dBm	No damage for VSWR=10:1
Max Pin (Ruggedness - 50Ω)			15	dBm	No damage for VSWR=1:1
CW P1dB		37		dBm	TX mode in 50% Duty Cycle
ESD					
Human Body Mode	500			V	EIA/JESD22-114A RF pins
	500			V	EIA/JESD22-114A DC pins
Charge Device Model	500			V	JESD22-C101C all pins
Thermal Resistance					
R _{THJ}		8.5		°C/W	

Parameter	Specification			Unit	Condition
	Min.	Typ.	Max.		
Typical Conditions					T=25 °C, V _{CC} =5.0V, V _{REG} =2.85V, using an IEEE802.16e waveform, 10MHz BW, unless otherwise noted
Frequency	2500		2700	MHz	Compliance with standard 802.16e
802.16e Output Power	29	30		dBm	
EVM		2.5		%	
Gain	32	34		dB	
Gain variation over Temp			+/-2.5	dB	
Second Harmonic		-25		dBm/MHz	
Third Harmonic		-50		dBm/MHz	
Low Gain Mode - Gain Reduction	20	25		dB	Drop in gain vs. high gain mode by setting V _{REG2} =0
Power Detect Range	0.2		2.8	V	P _{OUT} = 0 to 30dBm, usable range from 0 to 33dBm
Power Detect Power Range	10		33	dBm	
Input Return Loss - Tx_in pin	10	15		dB	In specified frequency band
Output Return Loss	8	10		dB	In specified frequency band
Operating Current		1500	1800	mA	At P _{OUT} = 30dBm
Quiescent Current		950	1050	mA	V _{CC} = 5.0, V _{REG} = 2.85V and RF=OFF
I _{REG}		13	18	mA	
P _{DOWN} Current			30	mA	P _{DOWN} = 0V, V _{REG} = 2.85V, V _{CC} = 5V
Leakage Current		0.25	0.4	mA	V _{CC} = 5V, V _{REG} =0V, P _{DOWN} = 0V
Power Supply - V _{CC}		5	5.25	V	
Power supply - V _{REG} (at Eval Board pin)	2.8	2.85	3	V	

Pin	Function	Description
1	NC	No Connection internal. Can be grounded or left open.
2	NC	No Connection internal. Can be grounded or left open.
3	NC	No Connection internal. Can be grounded or left open.
4	RFIN	RF input, internal DC blocked.
5	RFIN	RF input, internal DC blocked.
6	NC	No Connection internal. Can be grounded or left open.
7	PENABLE	PA Enable pin; Apply <0.6VDC to power down the three power amplifier stages. Apply 1.75VDC to 5.0VDC to enable PA.
8	VREG1	First stage bias voltage. This Pin requires regulated supply for best performance.
9	VREG2	Second stage bias voltage. This Pin requires regulated supply for best performance.
10	VREG3	Third stage bias voltage. This Pin requires regulated supply for best performance.
11	VBIAS	Supply voltage for the bias reference and control circuits. May be connected with VCC1, VCC2, VCC3 as long as appropriate isolation is provided.
12	VCC1	This pin is connected internally to the collector of the 1st stage RF device. To achieve specified performance, the layout of these pins should match the Recommended Land Pattern.
13	NC	No Connection internal. Can be grounded or left open.
14	VCC2	This pin is connected internally to the collector of the 2nd stage RF device. To achieve specified performance, the layout of these pins should match the Recommended Land Pattern.
15	NC	No Connection internal. Can be grounded or left open.
16	PDET	Power detector provides an output voltage proportional to the RF output power level.
17	RFOUT	RF Output. Need external DC block.
18	RFOUT	RF Output. Need external DC block.
19	RFOUT	RF Output. Need external DC block.
20	RFOUT	RF Output. Need external DC block.
21	RFOUT	RF Output. Need external DC block.
22	RFOUT	RF Output. Need external DC block.
23	RFOUT	RF Output. Need external DC block.
24	RFOUT	RF Output. Need external DC block.
25	NC	No Connection internal. Can be grounded or left open.
26	NC	No Connection internal. Can be grounded or left open.
27	VCC2	This pin is connected internally to the collector of the 2nd stage RF device. To achieve specified performance, the layout of these pins should match the Recommended Land Pattern.
28	NC	No Connection internal. Can be grounded or left open.
29	VCC1	This pin is connected internally to the collector of the 1st stage RF device. To achieve specified performance, the layout of these pins should match the Recommended Land Pattern.
30	VBIAS	Supply voltage for the bias reference and control circuits. May be connected with VCC1, VCC2, VCC3 as long as appropriate isolation is provided.
31	NC	No Connection internal. Can be grounded or left open.
32	NC	No Connection internal. Can be grounded or left open.
PkG Base	GND	Ground connection. The back side of the package should be connected to the ground plane through as short a connection as possible, for example, PCB vias under the device are recommended.

Theory of Operation and Applications

The RF5652 is a High Power Amplifier (PA) for high performance WiFi applications in the 2.4GHz to 2.5GHz ISM band, to address IEEE 802.11b/g/n customer premises equipment (CPE) application, and WiMAX 2.5GHz to 2.7GHz CPE application. The RF5652 has an integrated three stage linear Power Amplifier to provide 30dBm (1 Watt) linear power at PA output. The device is manufactured using InGaP HBT processes in a 5mm x 5mm x 0.85mm QFN package. To reduce the design and optimization process on the customer application, the evaluation board layout should be copied as close as possible, in particular the ground and via configurations. Gerber files of RFMD PCB designs can be provided upon request. The supply voltage lines should present an RF short to the FEM by using bypass capacitors on the V_{CC} traces. To simplify bias conditions, the RF5652 requires a single positive supply voltage (V_{CC}), a positive current control bias (V_{REG}) supply and a high impedance enable pin (PENABLE). The built-in Power Detector of the RF5652 can be used as power monitor in the system.

RF5652 PA Operation

The RF5652 has a typical gain of 34dB from 2.4GHz to 2.5GHz, and delivers > 29.5dBm typical output power in 11n HT20 MCS7 and >30dBm typical in 11g 54Mbps with a Dynamic EVM < 3%. For WiMAX application, RF5652 delivers 30dBm typical output power in WiMAX 10MHz BW with EVM < 2.5%. The RF5652 requires a single positive of 5.0V to operate at full specifications. The V_{REG} pin requires a regulated supply at 2.85V to maintain nominal bias current.

RF5652 Biasing Instructions to the Eval board:

- 802.11b/g/n Transmit:
- Connect the PA to a signal generator at the input and a spectrum analyzer at the output. Set the Pin at signal generator is at -20dBm.
- Bias V_{CC} to 5.0V first with $V_{REG}=0.0V$. If available, enable the current limiting function of the power supply to 2000 mA.
- Turn on V_{REG} to 2.85V (typ.).
- On V_{REG} (of Eval board), regulated supply is recommended. Be extremely careful not to exceed 3.0V on the V_{REG} pin or the part may exceed device current limits.
- Turn on Pdown to 2.85V (typ.). Pdown Pin can be tied to V_{REG} supply.
- The above steps apply to WIMAX Transmit test.

NOTE: It is important to adjust the V_{CC} voltage source so that +5V is measured at the board; and the +2.85V of V_{REG} is measured at the board. The high collector currents will drop the collector voltage significantly if long leads are used. Adjust the bias voltage to compensate.

- Turn on RF of signal generator and gradually increase power level to the rated power.

CAUTION: If the input signal exceeds the maximum rated power, the RF5652 Evaluation Board can be permanently damaged.

- To turn off PA, turn off RF power of signal generator; then Pdown, V_{REG} and V_{CC} .

General Layout Guidelines and considerations:

For best performance the following layout guidelines and considerations must be followed regardless of final use or configuration:

1. The ground pad of the RF5652 has special electrical and thermal grounding requirements. This pad is the main RF ground and main thermal conduit path for heat dissipation. The GND pad and vias pattern and size used on the RFMD evaluation board should be replicated. The RFMD layout files in Gerber format can be provided upon request. Ground paths (under device) should be made as short as possible.
2. The RF lines should be well separated with solid ground in between the traces to eliminate any possible RF leakages or cross-talking.

3. Bypass capacitors should be used on the DC supply lines. The V_{CC} lines may be connected after the RF bypass and decoupling capacitors to provide better isolation between each V_{CC} line.

RF5652 PA production and system calibration recommendation:

It's highly recommended to follow the DC biasing step and RF power settings in the production calibration or test.

1. Connect the RF cables of input and output then connect to the proper equipment.
2. Apply V_{CC} , then V_{REG} as per the data sheet recommendations.
3. Set PA in TX mode.
4. Apply PENABLE = high.
5. Set RF input to the desired frequency and initial RF input power at -20dBm. This will insure the Power amplifier is in a linear state and not over driven.
6. Sweep RF from low to high output power and take measurements at the rated output power.
7. Insure that the output power at turn on doesn't saturate the power amplifier. The recommended output power should be about 10dB to 20dB below the nominal input power. xxStart calibrating from low to high power in reasonable steps until the rated power is reached then take the measurements.

CAUTION: If the input signal exceeds the maximum rated input power specifications, the RF5652 could be permanently damaged.

Package Drawing

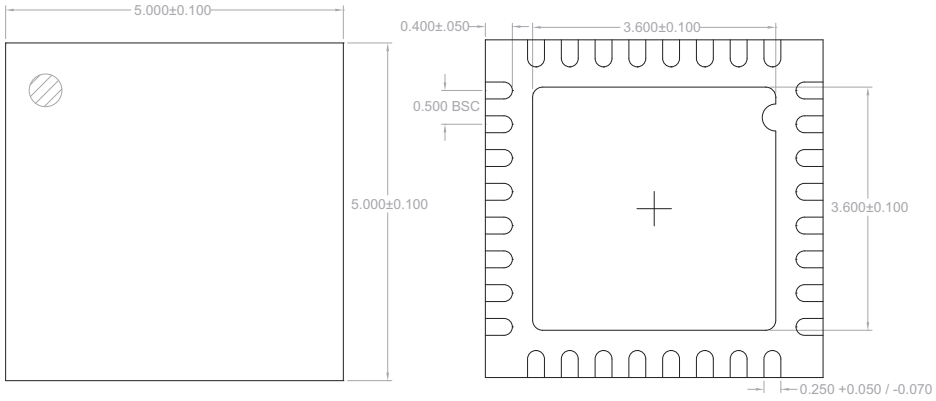

TOP VIEW

BOTTOM VIEW

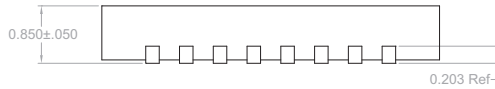

SIDE VIEW

A = 0.270 x 0.528 (mm)
B = 0.528 x 0.270 (mm)
C = 3.600 x 3.600 (mm)

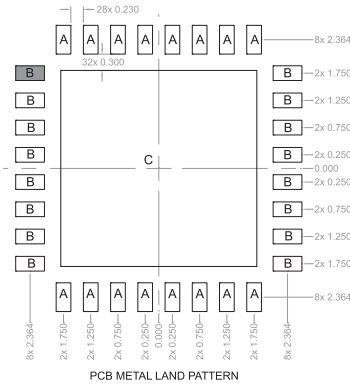

PCB METAL LAND PATTERN

A = 0.400 x 0.658 (mm)
B = 0.658 x 0.400 (mm)
C = 3.730 x 3.730 (mm)

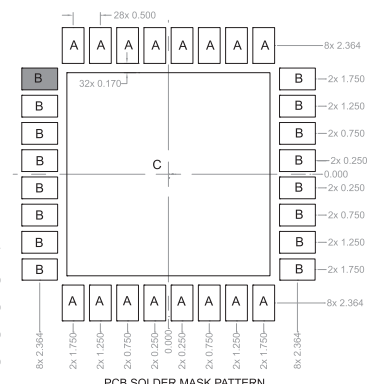

PCB SOLDER MASK PATTERN

A = 0.243 x 0.475 (mm)
B = 0.475 x 0.243 (mm)
C = 1.530 x 1.530 (mm)

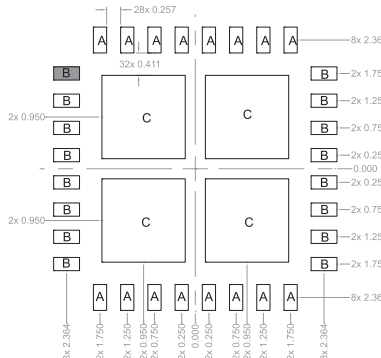

PCB STENCIL PATTERN

Note: Thermal vias for center slug "C" should be incorporated into the PCB design. The number and size of thermal vias will depend on the application, the power dissipation, and the electrical requirements. Example of the number and size of vias can be found on the RFMD evaluation board layout..

Pin Out

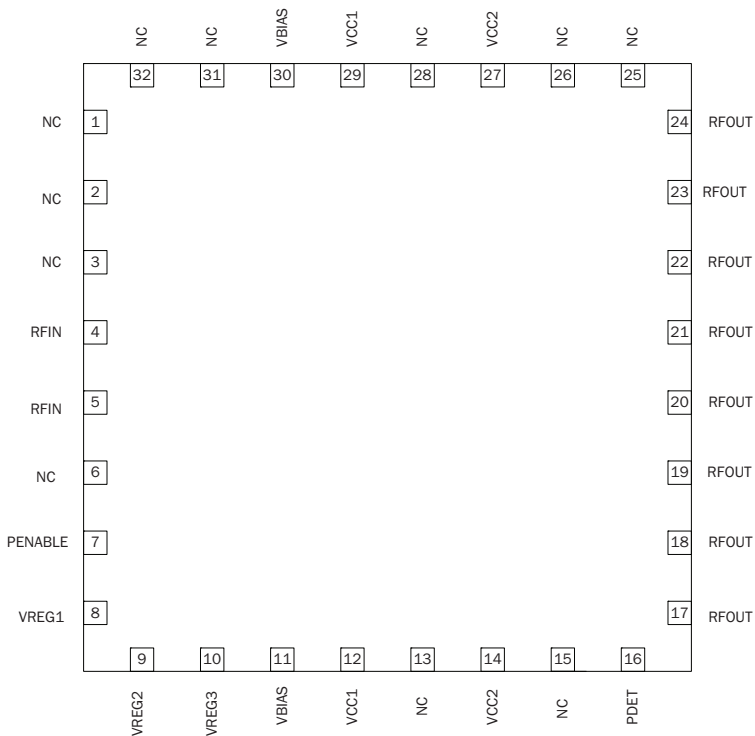

Evaluation Board Schematic
WiFi Application

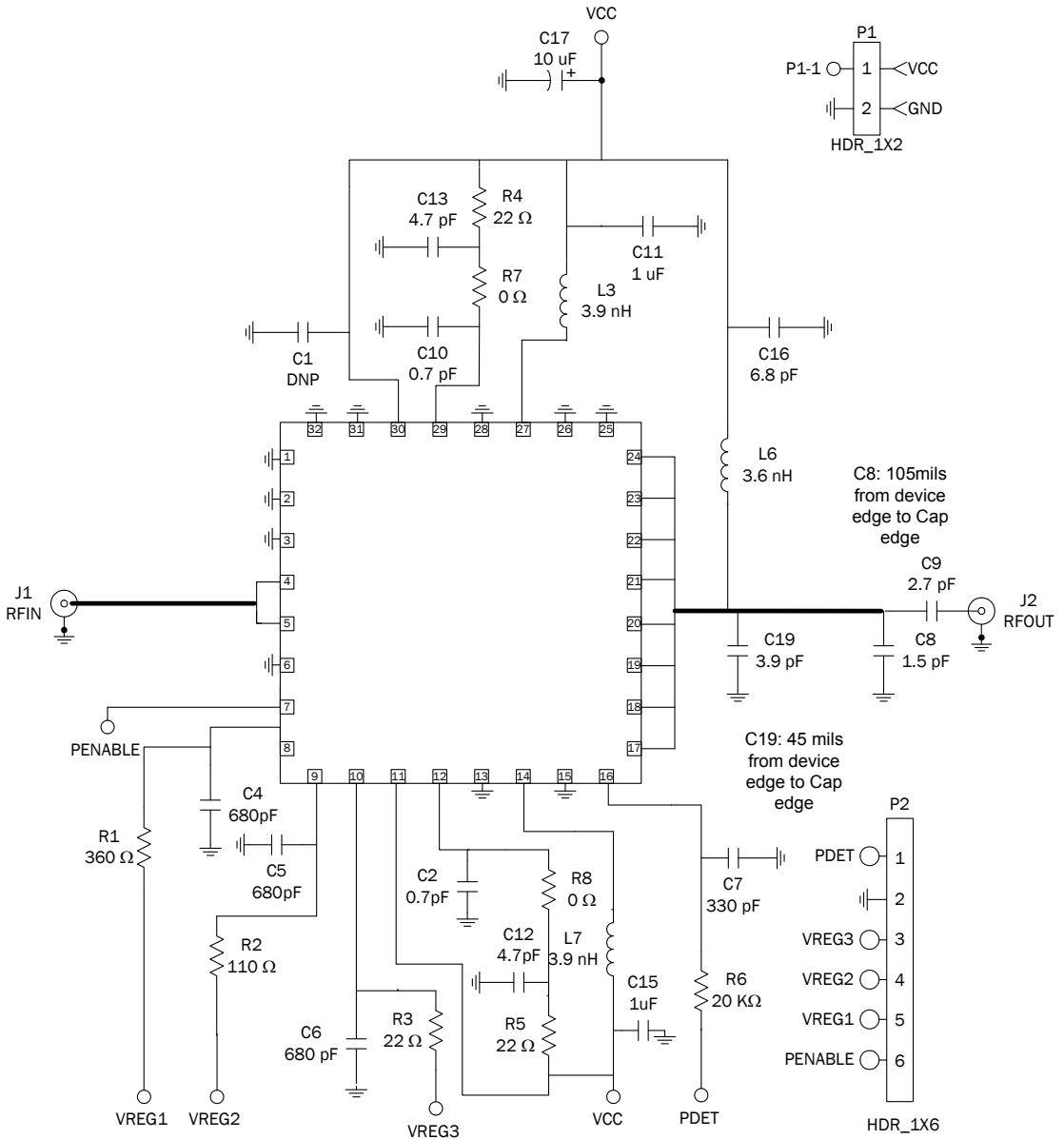

WLAN Evaluation Board BOM

Description	Qty	Reference Designator	Manufacturer	Manufacturer's P/N
CAP, 10uF, 10%, 10V, X5R, 0805	1	C17	Murata Electronics	GRM21BR61A106KE19L
CAP, 6.8pF, 5%, 50V, C0G, 0402	1	C16	Murata Electronics	GJM1555C1H6R8CB01E
CAP, 680pF, 5%, 50V, C0G, 0402	2	C5, C6	Murata Electronics	GRM1555C1H681JZ01D
CAP, 330pF, 10%, 50V, X7R, 0402	1	C7	Murata Electronics	GRM155R71H331KA01E
CAP, 1uF, 10%, 10V, X5R, 0402	2	C11, C15	Murata Electronics	GRM155R61A105KE15D
CAP, 4.7pF, +/-0.25pF, 50V, HI-Q, 0402	2	C12, C13	Murata Electronics	GJM1555C1H4R7CB01E
CAP, 0.7pF, +/-0.25pF, 50V, HI-Q, 0402	2	C2, C10	Murata Electronics	GRM1555C1HR70BZ01D
CAP, 1.5pF, +/-0.25pF, 50V, HI-Q, 0402	1	C8 - 105mils from QFN edge	Murata Electronics	GJM1555C1H1R5CB01E
CAP, 3.9pF, +/-0.25pF, 50V, HI-Q, 0402	1	C19 - 45mils from QFN edge	Murata Electronics	GRM1555C1H3R9CZ01E
CAP, 2.7pF, +/-0.25pF, 50V, HI-Q, 0402	1	C9	Murata Electronics	GRM1555C1H2R7CZ01E
RES, 360 OHM, 5%, 1/16W, 0402	1	R1	Kamaya, Inc	RMC1/16S-361JTH
RES, 110 OHM, 5%, 1/16W, 0402	1	R2	Panasonic Industrial Co	ERJ-2GJE1111X
RES, 22 OHM, 5%, 1/16W, 0402	3	R3, R4, R5	Kamaya, Inc	RMC1/16S-220JTH
RES, 20 KOHM, 5%, 1/16W, 0402	1	R6	KOA Speer Electronics, Inc.	RK73H1ETP2002F
IND, 3.9nH, 5%, WW, 0603	1	L6	Coilcraft	0603HC-3N9XJLW
RES, 0 OHM, 0402	2	R7, R8	Kamaya, Inc	RMC1/16SJPTH
IND, 3.9nH, +/-0.3nH, ML, 0402	2	L3, L7	Murata Electronics	LQP15MN3N9B02D
DNI	4	C1, C3, C4, C14		
RF5652 5x5mm, QFN32	1	U1	RFMD	

Evaluation Board Schematic
WiMAX Application

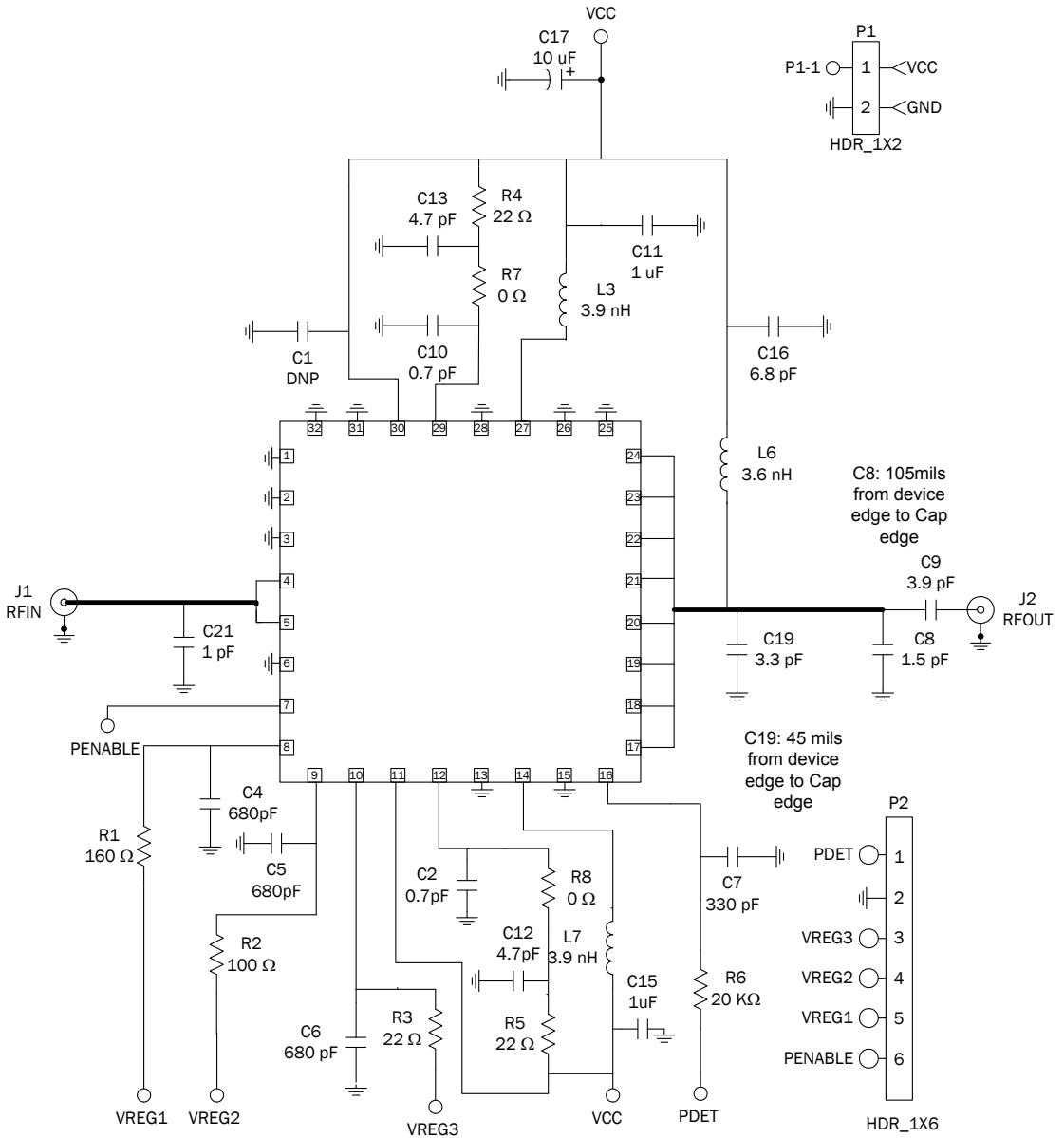

WiMAX Evaluation Board BOM

Description	Qty	Reference Designator	Manufacturer	Manufacturer's P/N
CAP, 10uF, 10%, 10V, X5R, 0805	1	C17	Murata Electronics	GRM21BR61A106KE19L
CAP, 6.8pF, 5%, 50V, C0G, 0402	1	C16	Murata Electronics	GJM1555C1H6R8CB01E
CAP, 680pF, 5%, 50V, C0G, 0402	2	C5, C6	Murata Electronics	GRM1555C1H681JZ01D
CAP, 330pF, 10%, 50V, X7R, 0402	1	C7	Murata Electronics	GRM155R71H331KA01E
CAP, 1uF, 10%, 10V, X5R, 0402	2	C11, C15	Murata Electronics	GRM155R61A105KE15D
CAP, 4.7pF, +/-0.25pF, 50V, HI-Q, 0402	2	C12, C13	Murata Electronics	GJM1555C1H4R7CB01E
CAP, 0.7pF, +/-0.25pF, 50V, HI-Q, 0402	2	C2, C10	Murata Electronics	GRM1555C1HR70BZ01D
CAP, 1.5pF, +/-0.25pF, 50V, HI-Q, 0402	1	C8 - 105mils from QFN edge	Murata Electronics	GJM1555C1H1R5CB01E
CAP, 3.3pF, +/-0.1pF, 50V, HI-Q, 0402	1	C19 - 45mils from QFN edge	Murata Electronics	GRM1555C1H3R3BZ01E
CAP, 3.9pF, +/-0.25pF, 50V, HI-Q, 0402	1	C9	Murata Electronics	GRM1555C1H3R9CZ01E
CAP, 1.0pF, +/-0.25pF, 50V, HI-Q, 0402	1	C21 - 165mils from QFN edge	Murata Electronics	GJM1555C1H1R0CB01E
RES, 160 OHM, 5%, 1/16W, 0402	1	R1	Kamaya, Inc	RMC1/16S-161JTH
RES, 100 OHM, 5%, 1/16W, 0402	1	R2	Kamaya, Inc	RMC1/16S-101JTH
RES, 22 OHM, 5%, 1/16W, 0402	3	R3, R4, R5	Kamaya, Inc	RMC1/16S-220JTH
RES, 20 KOHM, 5%, 1/16W, 0402	1	R6	KOA Speer Electronics, Inc.	RK73H1ETP2002F
IND, 3.9nH, 5%, WW, 0603	1	L6	Coilcraft	0603HC-3N9XJLW
RES, 0 OHM, 0402	2	R7, R8	Kamaya, Inc	RMC1/16SJPTH
IND, 3.9nH, +/-0.3nH, ML, 0402	2	L3, L7	Murata Electronics	LQP15MN3N9B02D
DNI	4	C1, C3, C4, C14		
RF5652 5x5mm, QFN32	1	U1	RFMD	

RF5652 WLAN Evaluation Board Top Layer

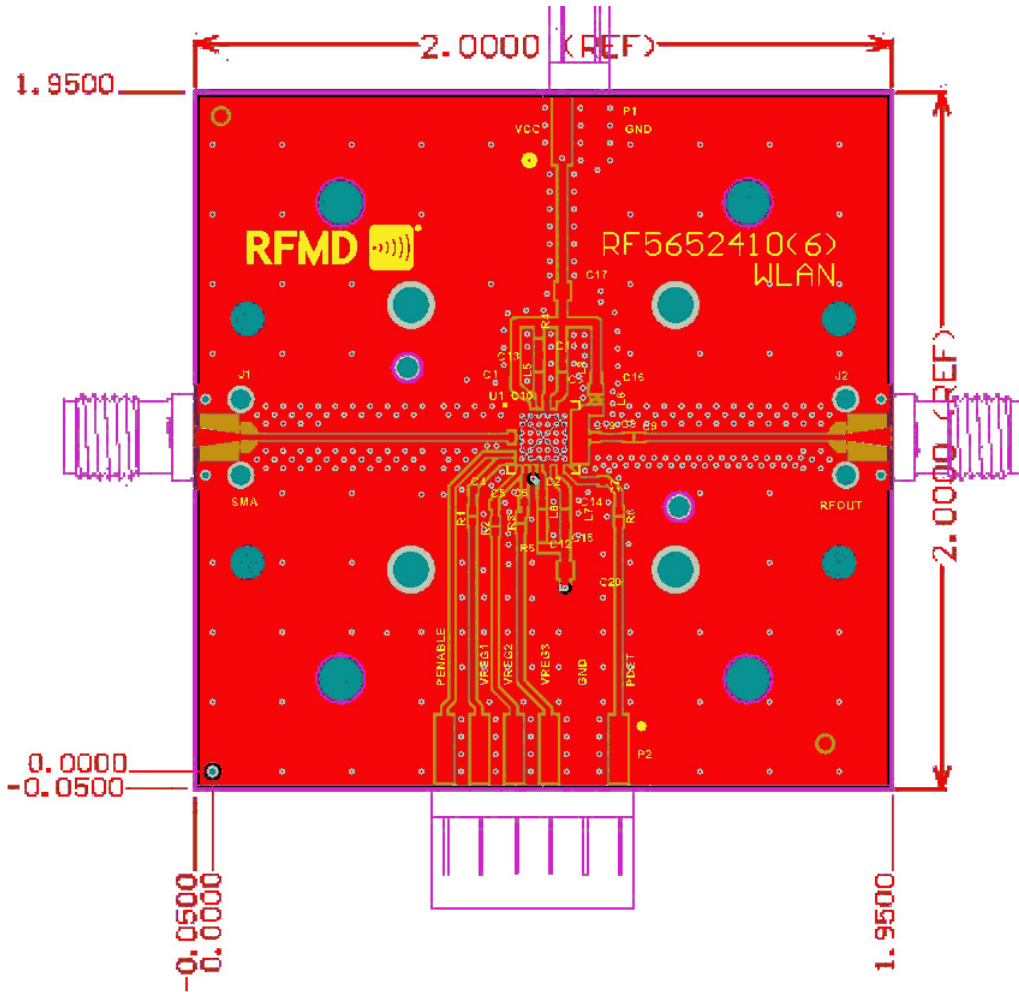

RF5652 WLAN Evaluation Board Bottom Layer

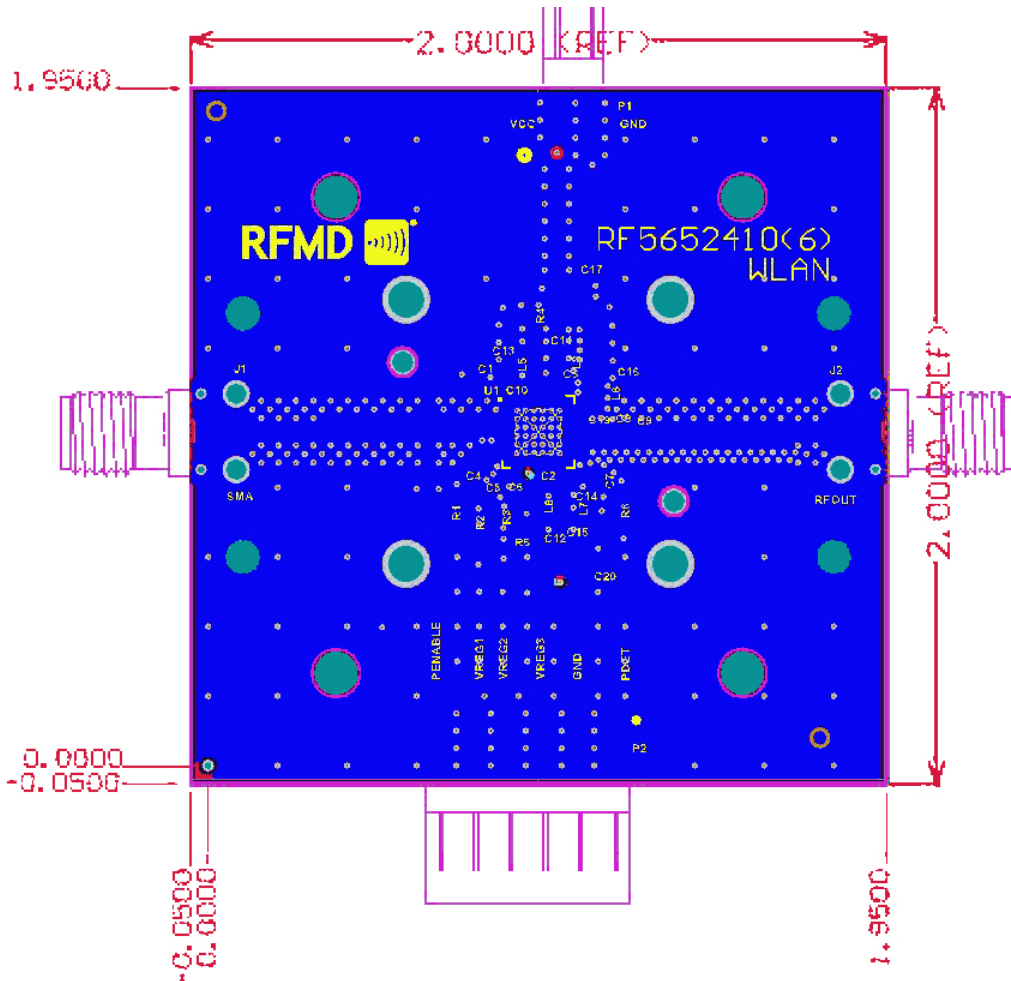

WiFi 802.11n Performance Plots in 100% Duty Cycle

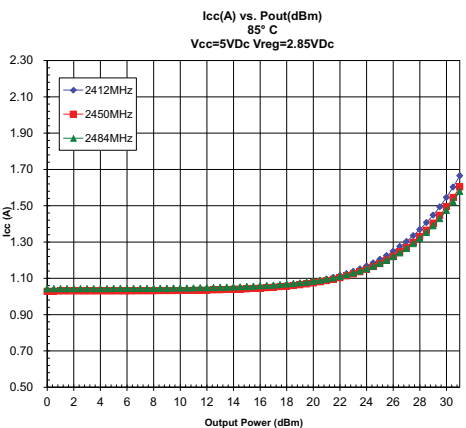
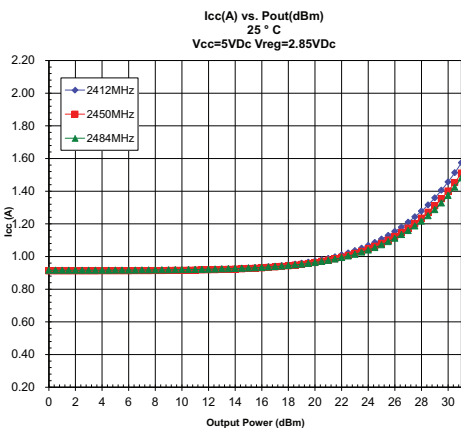
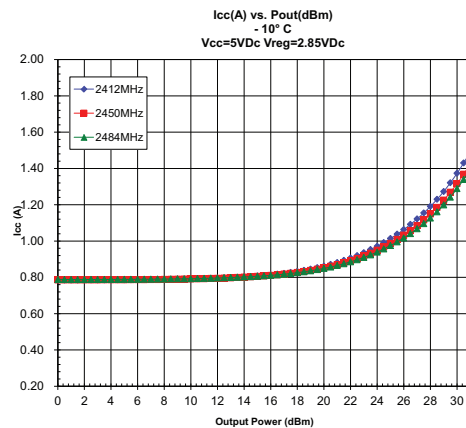
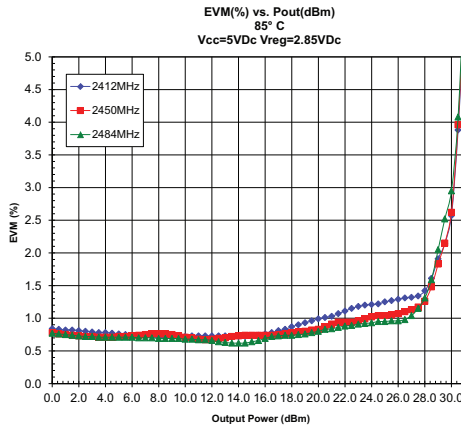
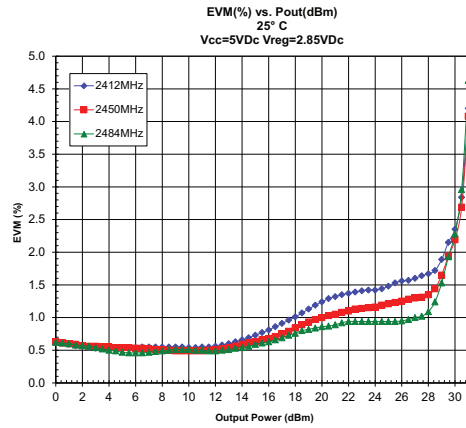
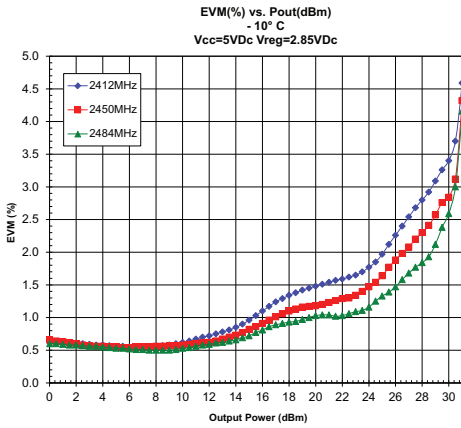

WiFi 802.11n Performance Plots in 100% Duty Cycle

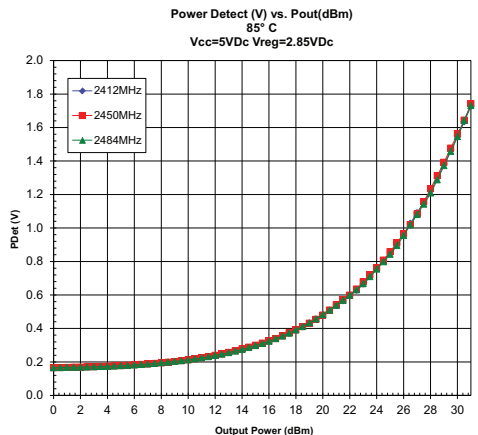
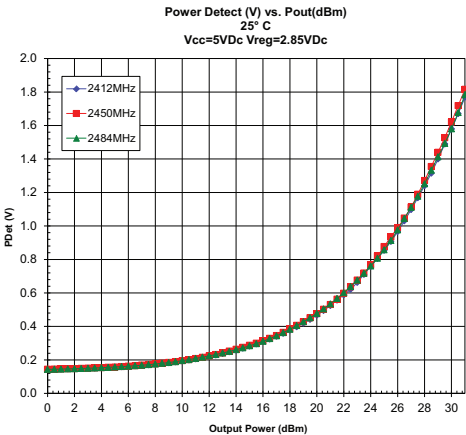
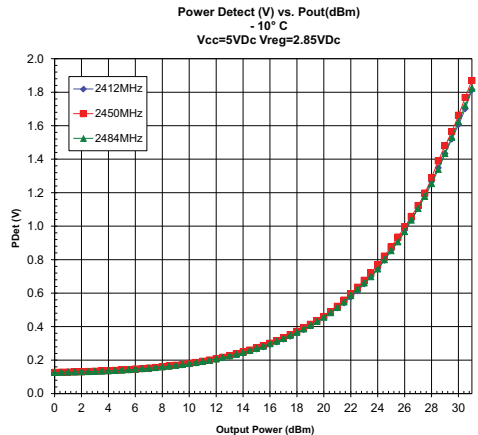
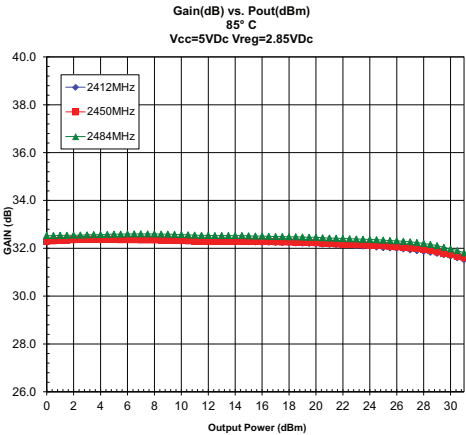
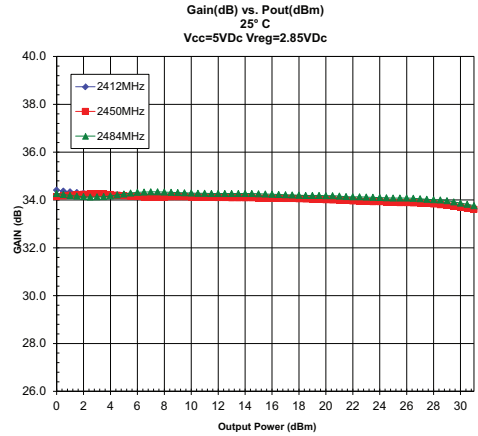
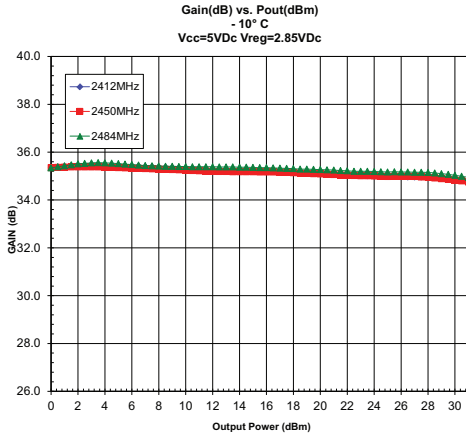

WiFi 802.11n Performance Plots in 50% Duty Cycle

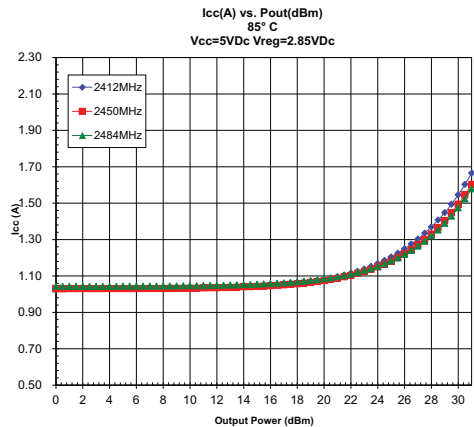
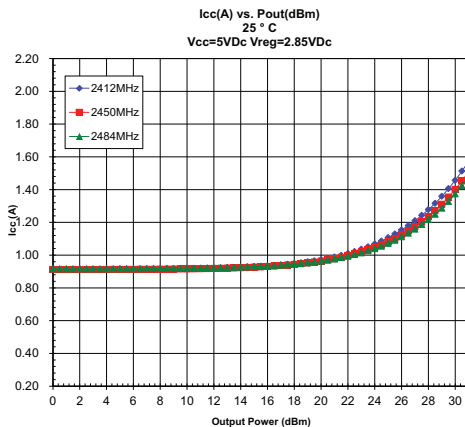
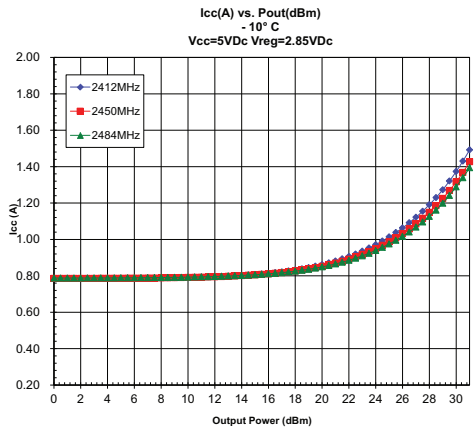
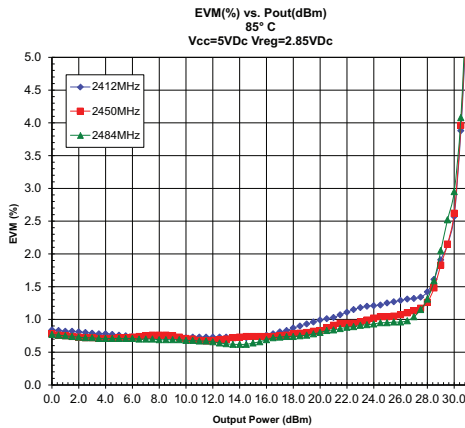
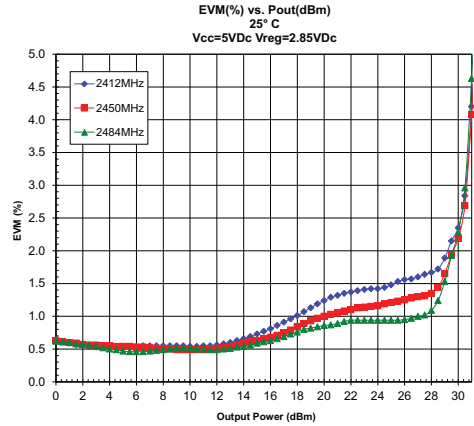
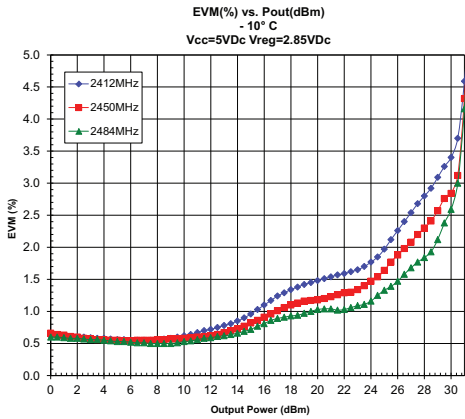

WiFi 802.11n Performance Plots in 50% Duty Cycle

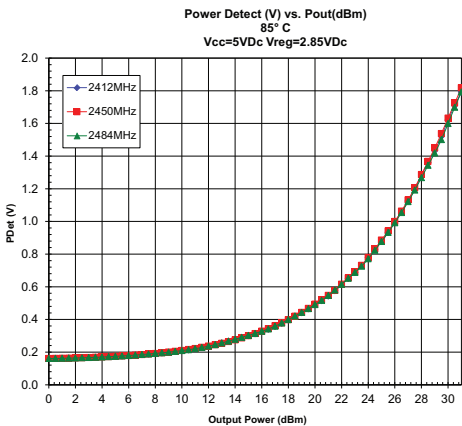
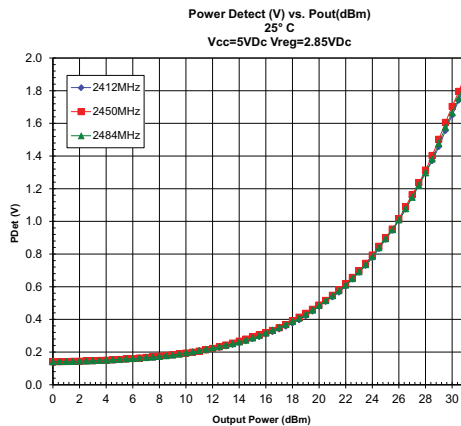
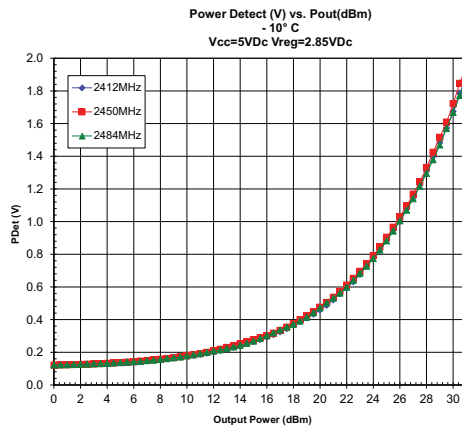
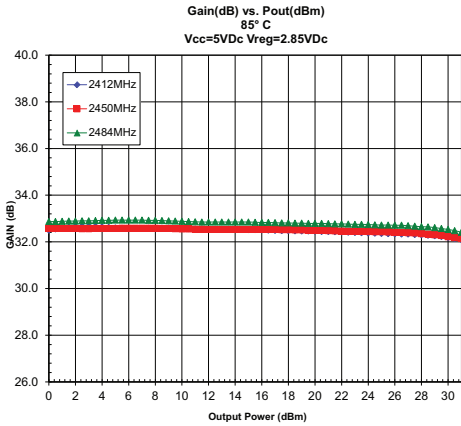
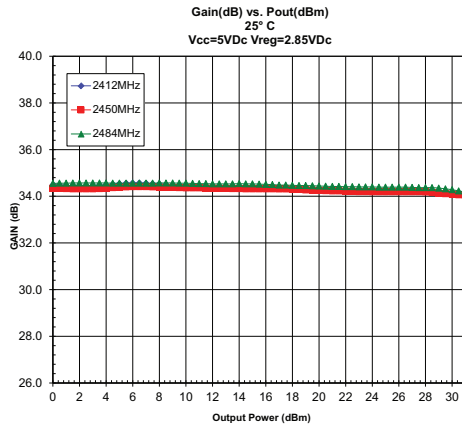
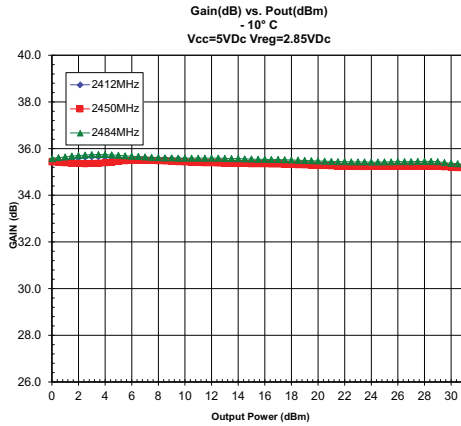

WiFi 802.11g Performance Plots in 100% Duty Cycle

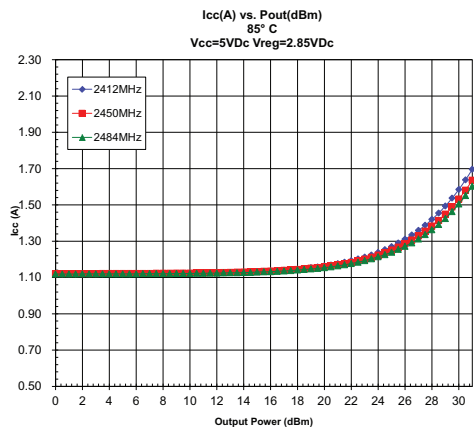
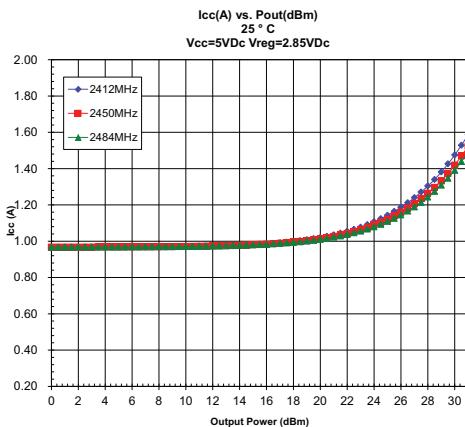
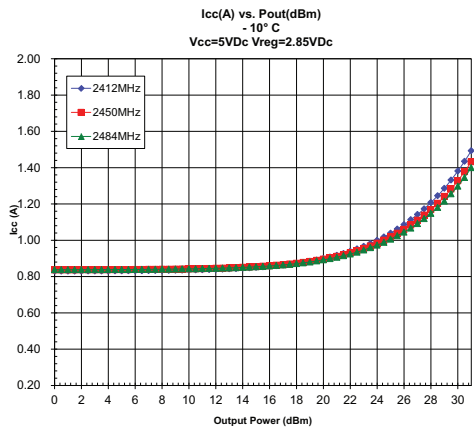
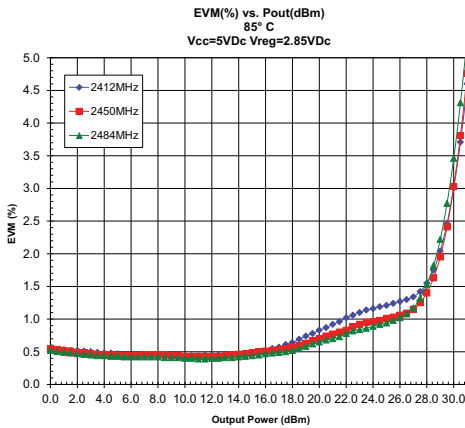
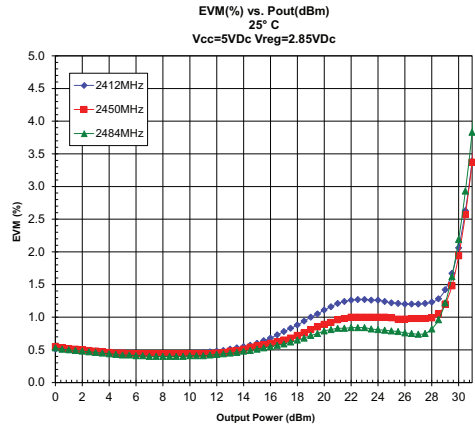
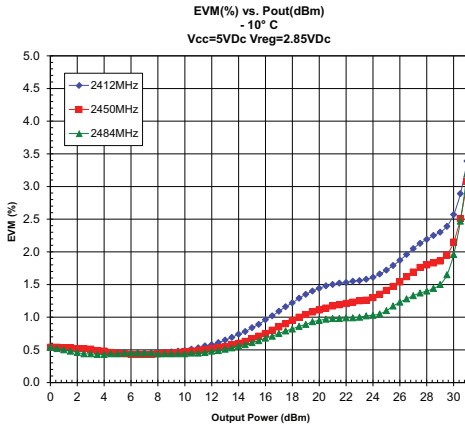

WiFi 802.11g Performance Plots in 100% Duty Cycle

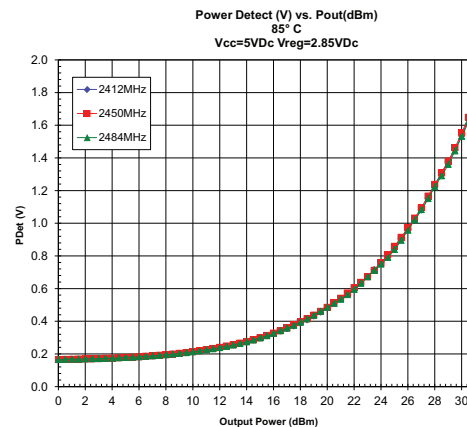
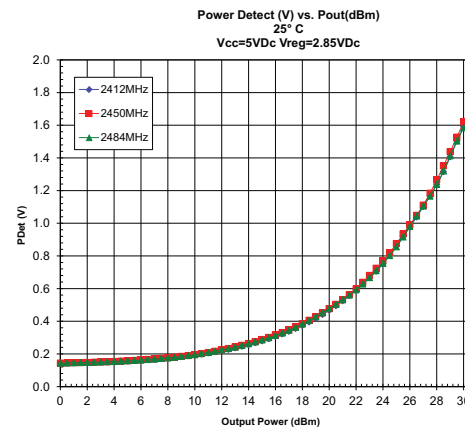
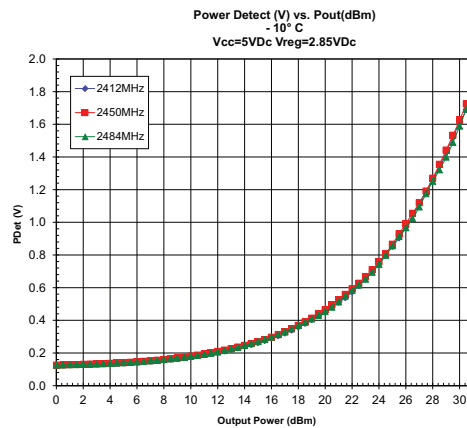
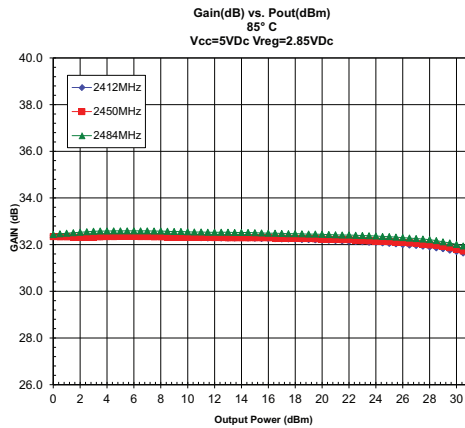
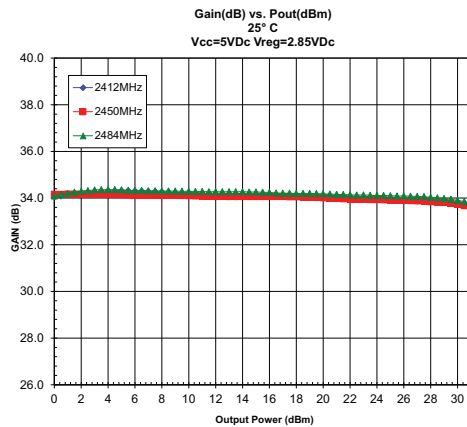
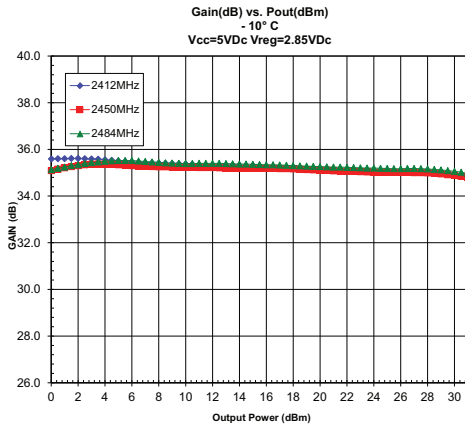

WiMAX Performance Plots

