

Product Features

- GaAs MMIC
- Very Low Distortion
- Guaranteed Broadband Power Gain
- Heat Sink 99.9% Copper, Ag or Gold Plate
- Excellent Thermal Conductivity
- Single Supply Voltage @ 24V
- Low DC Power Consumption
- No External Circuit needed

Application

- Drive Amplifier

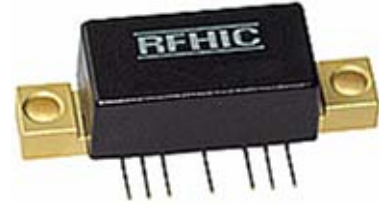

Description

The RFC1G22-24 is specifically designed for up to 1GHz in frequency as amplifiers. This hybrid dynamic range amplifier module operates with a single voltage supply of 24V(DC). The RFC1G22-24 is equipped with over-voltage suppressor.

Specifications

Absolute Maximum Ratings

PARAMETER	MIN	MAX	UNITS
V_{DD} / V_{RFOUT}	-	28	VDC
RF_{IN} (Single Tone)	-	+15	dBm
Storage Temperature	-40	+100	°C
Operating Temperature	-20	+100	°C

Electrical Specifications (TA = +25 °C, VDD = 24V)

PARAMETER	RFC 1G22-24		
	MIN	TYP	MAX
Bandwidth (MHz)	20	-	1000
Gain @1000MHz (dB)	21.0	22.0	-
Gain Flatness @ 20-1000MHz (dB)	-	1.5	2.0
Input / Output VSWR	2.5 : 1	2.0 : 1	
IP3 (dBm)@ 20-1000MHz	48.0	50.0	-
Power Output 1dB Comp. @ 20- 1000MHz (dBm)	29.0	30.0	
IMD3 (dBc) Two Tone 20dBm Output @ 20-1000MHz	56.0	60.0	-
Noise Figure (dB) @ 20-1000MHz	-	3.5	5.0
Supply Current (mA)	380	400	430

Typical RF Performance at 25°C

Parameter	Units	Typical		
Frequency	MHz	20	500	1000
S21 - Gain	dB	21	22	22
S11 – Input Return Loss	dB	-14	-30	-15
S22 – Output Return Loss	dB	-16	-16	-17
OIP1	dBm	29	30	29
OIP3	dBm	48.5	51	49
Noise Figure	dB	3.6	3.5	4.8
Supply Voltage	V	24		
Current	mA	380 ~ 430		

S-Parameters

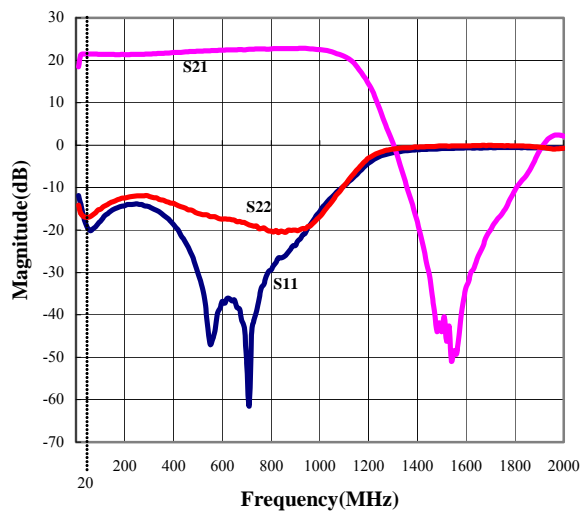

Power Output 1dB Compression

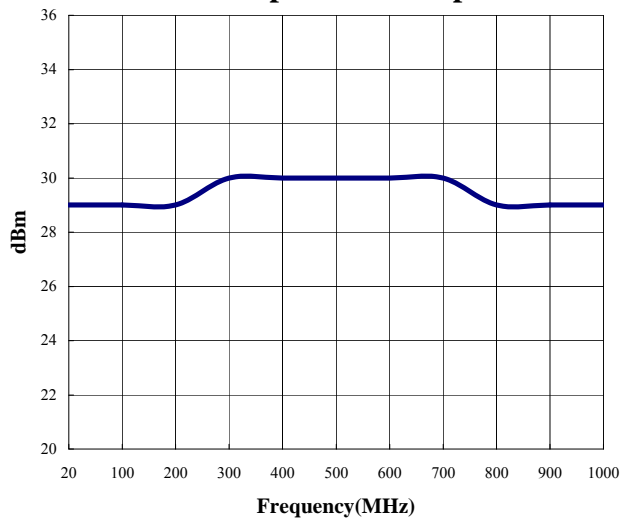

Noise Figure

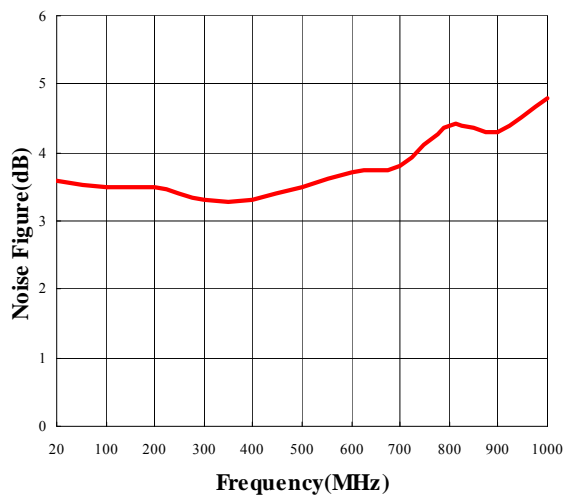

OIP3

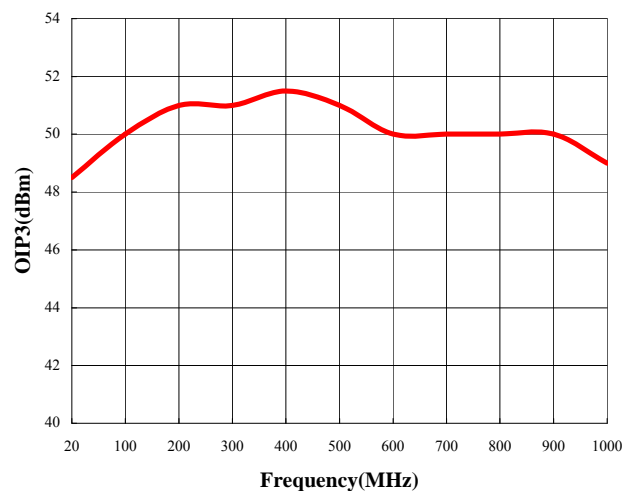

ESD PROTECTION

Gallium Arsenide Integrated Circuits are sensitive to electrostatic discharge (ESD) and can be damaged by static electricity. Proper ESD control techniques should be used when handling these devices. Some of the precautions recommended are;

- Person at a workbench should be earthed via a wrist strap and a resistor.
- All mains-powered equipment should be connected to the mains via an earth-leakage switch.
- Equipment cases should be grounded.
- Relative humidity should be maintained between 40% and 50%.
- An ionizer is recommended.
- Keep static materials, such as plastic envelopes and plastic trays etc. away from the workbench.

NOTES FOR CORRECT USE

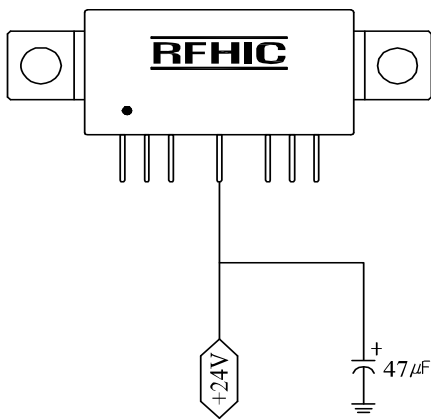

1. On the power input port (Pin#5), 47µF/35V capacitor GND is recommended.
2. The heat sink of CATV Hybrids is to be mounted in direct contact with the metal case of the equipment. Heat conducting grease should be applied to the module/equipment interface and the unit tightly secured.
3. Put the power off before adjusting in/output matching of the system.
4. The unit must have a common ground with the equipment and the analyzer.
5. Pay close attention to the input voltage not to over power the hybrid.
6. The space between bottom of socket and the tip of the lead is recommended to have space of 2mm+ to protect the pin
7. Do not open the plastic cover to change the matching inside the hybrid. Once opened, RFHIC will not be responsible for the hybrid.

Package Dimensions (Type: DP-27)

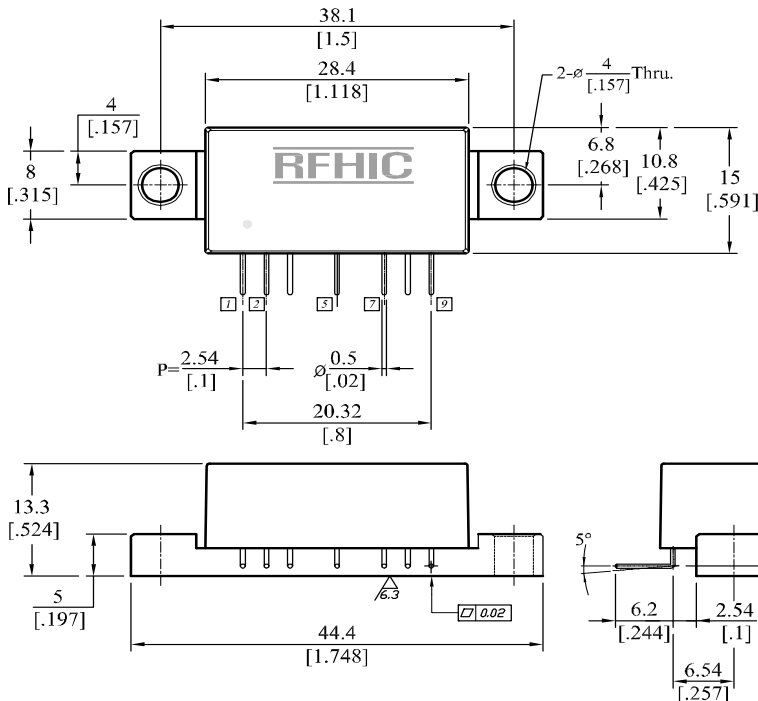

Unit : $\frac{\text{mm}}{\text{inch}}$	Tolerance : $\pm \frac{0.2}{.008}$
--	------------------------------------

Pin No.	Function
1	RF Input
2,3,7,8	Ground
5	Vcc
9	RF Output

RFHIC Corporation (RFHIC) reserves the right to make changes to any products herein or to discontinue any product at any time without notice. RFHIC do not assume any liability for the suitability of its products for any particular purpose, and disclaims any and all liability, including without limitation consequential or incidental damages. The product specifications herein expressed have been carefully checked and are assumed to be reliable. However, RFHIC disclaims liability for inaccuracies and strongly recommends buyers to verify that the information they are using is current before placing purchase orders. RFHIC products are not intended for use in life support equipment or application where malfunction of the product can be expected to result in personal injury or death. Buyer uses or sells such products for any such unintended or unauthorized application, buyer shall indemnify, protect and hold RFHIC and its directors, officers, stockholders, employees, representatives and distributors harmless against any and all claims arising out of such use. RFHIC's liability under or arising out of damages, claims of whatsoever kind and nature which RFHIC products could cause shall be limited in amount to the net purchase price of the products sold to buyer by RFHIC.