



Features

- High gain: 21dB
- High linearity and low distortion
 - 40dBm IP3
 - -65dBc CSO
 - -83dBc CTB
- Single +5V supply

Applications

- Broadband 75Ω Gain Block
- CATV Distribution Amplifiers
- Pre-Amplifier for CATV Multi-Dwelling Units
- Drop Amplifiers

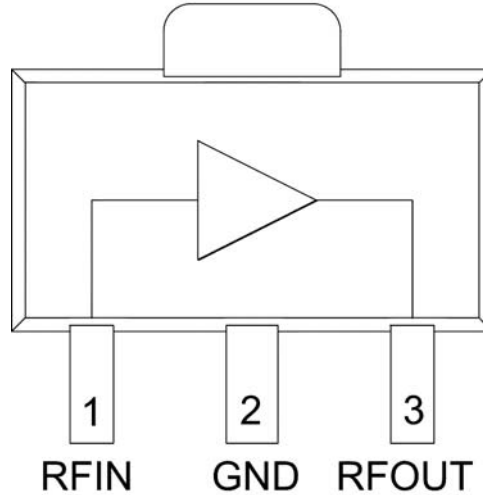

Functional Block Diagram

Product Description

RFCA3302 is a high performance InGaP HBT MMIC amplifier designed to run from a single +5V supply without the need for an external dropping resistor. The high gain, high linearity and low distortion from 40MHz to 1008MHz make this part ideal for broadband cable applications. An integrated bias circuit provides stable gain over temperature and process variations. It is offered in a small SOT-89 package and is RoHS compliant.

Ordering Information

RFCA3302SQ	Sample bag with 25 pieces
RFCA3302SR	7" Reel with 100 pieces
RFCA3302TR13	13" Reel with 2500 pieces
RFCA3302PCK-410	40MHz to 1008MHz, 75Ω, PCBA with 5-piece sample bag

Optimum Technology Matching® Applied

- | | | | |
|---|--------------------------------------|-------------------------------------|------------------------------------|
| <input type="checkbox"/> GaAs HBT | <input type="checkbox"/> SiGe BiCMOS | <input type="checkbox"/> GaAs pHEMT | <input type="checkbox"/> GaN HEMT |
| <input type="checkbox"/> GaAs MESFET | <input type="checkbox"/> Si BiCMOS | <input type="checkbox"/> Si CMOS | <input type="checkbox"/> BiFET HBT |
| <input checked="" type="checkbox"/> InGaP HBT | <input type="checkbox"/> SiGe HBT | <input type="checkbox"/> Si BJT | <input type="checkbox"/> LDMOS |

RF MICRO DEVICES®, RFMD®, Optimum Technology Matching®, Enabling Wireless Connectivity™, PowerStar®, POLARIS™ TOTAL RADIO™ and UltimateBlue™ are trademarks of RFMD, LLC. BLUETOOTH is a trademark owned by Bluetooth SIG, Inc., U.S.A. and licensed for use by RFMD. All other trade names, trademarks and registered trademarks are the property of their respective owners. ©2012, RF Micro Devices, Inc.

Absolute Maximum Ratings

Parameter	Rating	Unit
Device Voltage	5.5	V
RF Input Power	15	dBm
Operating Temperature Range	-40 to +85	°C
Storage Temperature Range	-40 to +150	°C



Caution! ESD sensitive device.

Exceeding any one or a combination of the Absolute Maximum Rating conditions may cause permanent damage to the device. Extended application of Absolute Maximum Rating conditions to the device may reduce device reliability. Specified typical performance or functional operation of the device under Absolute Maximum Rating conditions is not implied.

The information in this publication is believed to be accurate and reliable. However, no responsibility is assumed by RF Micro Devices, Inc. ("RFMD") for its use, nor for any infringement of patents, or other rights of third parties, resulting from its use. No license is granted by implication or otherwise under any patent or patent rights of RFMD. RFMD reserves the right to change component circuitry, recommended application circuitry and specifications at any time without prior notice.



RoHS (Restriction of Hazardous Substances): Compliant per EU Directive 2002/95/EC.

Parameter	Specification			Unit	Condition
	Min.	Typ.	Max.		
Overall (75Ω)					
Frequency Range	40		1008	MHz	
Gain	19	21.5	22.5	dB	
Gain Flatness		±1.5		dB	40MHz to 1008MHz
Noise Figure		3	3.5	dB	
Input Return Loss	-10	-15		dB	
Output Return Loss	-10	-13		dB	
Output IP3	36	40		dBm	Two tones, 50MHz, 56MHz, 0dBm at output
	34	38		dBm	Two tones, 500MHz, 506MHz, 0dBm at output
	30	34		dBm	Two tones, 1002MHz, 1008MHz, 0dBm at output
Output P1dB	16	19		dBm	40MHz to 1008MHz
Distortion					
CSO		-65	-60	dBc	79 Channels to 550MHz, 26dBmV P _{OUT}
CTB		-83	-75	dBc	
XMOD		-85	-74	dBc	
Thermal					
Theta JC		66		°C/W	Referenced to the GND via of Pin 2
Maximum Junction Temperature			150	°C	
Power Supply					
Supply Voltage (V _{DD})	4.75	5	5.25	V	
Operating Current Range	105	125	145	mA	

Typical Performance Curves (75Ω)

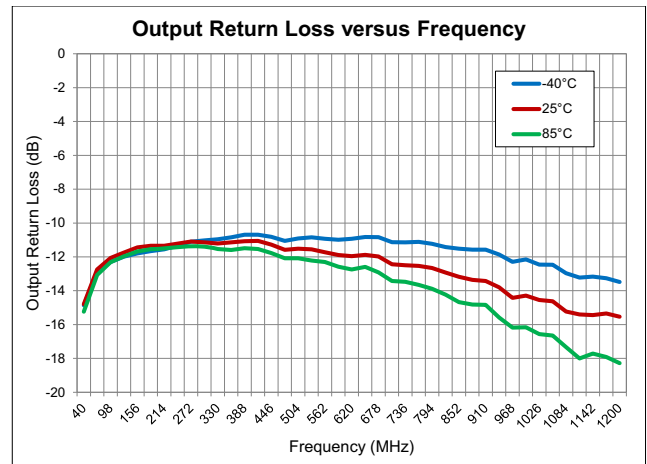
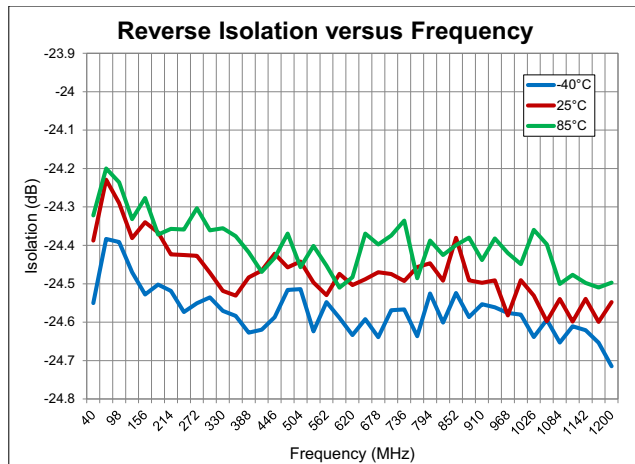
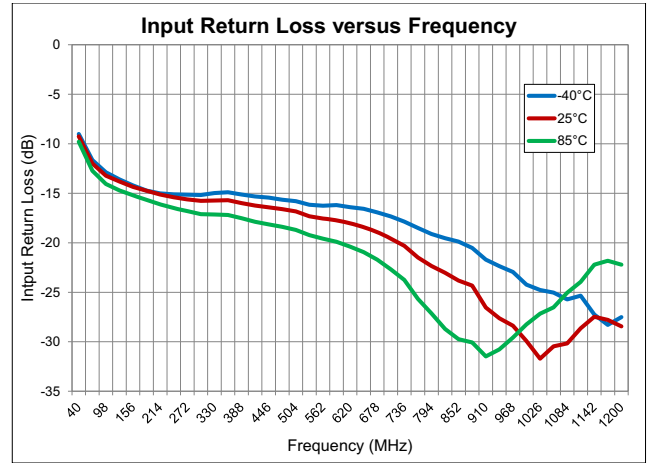
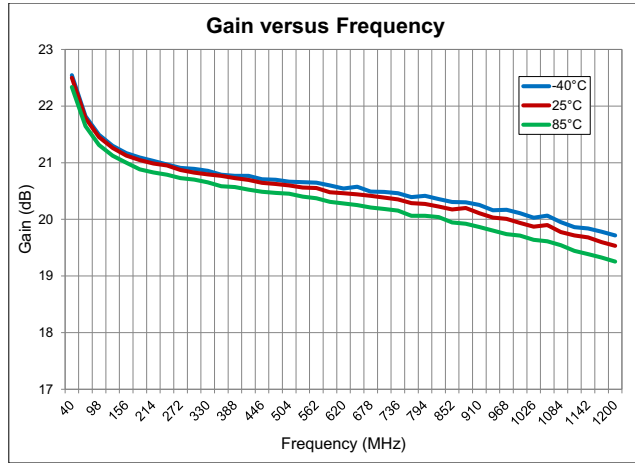

Linearity and Noise Figure Data (75Ω)

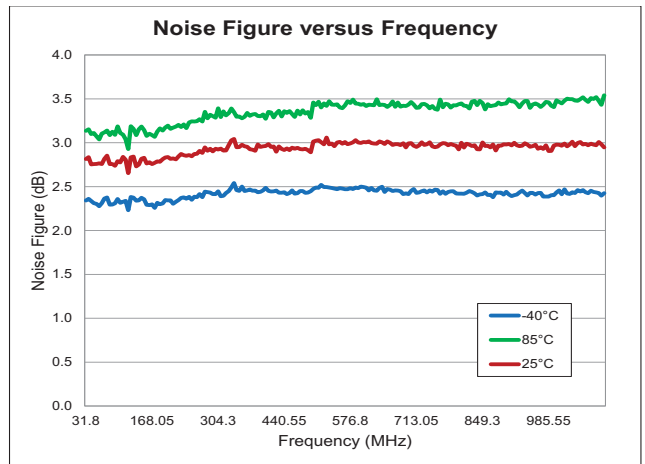
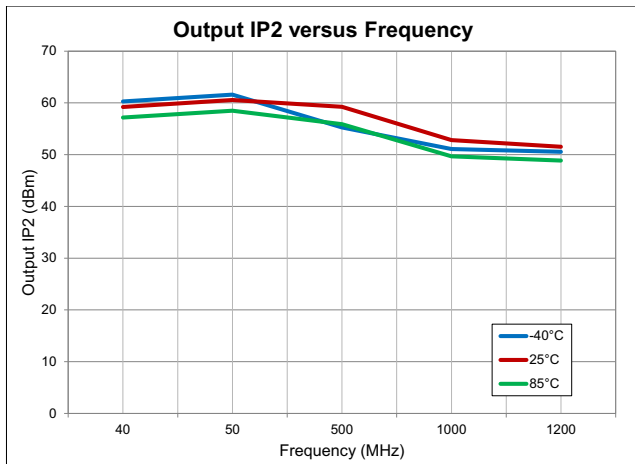
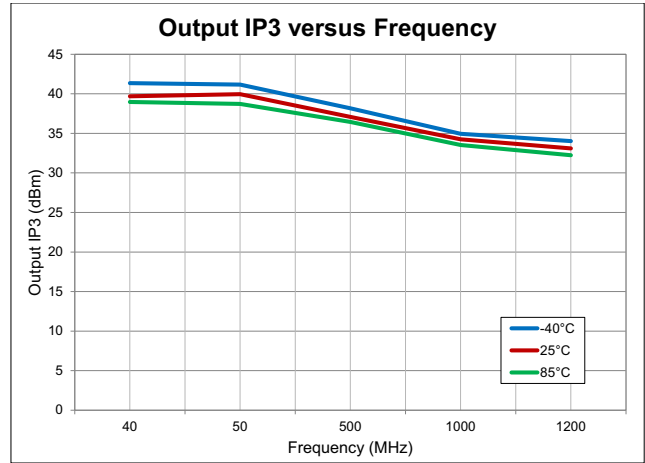
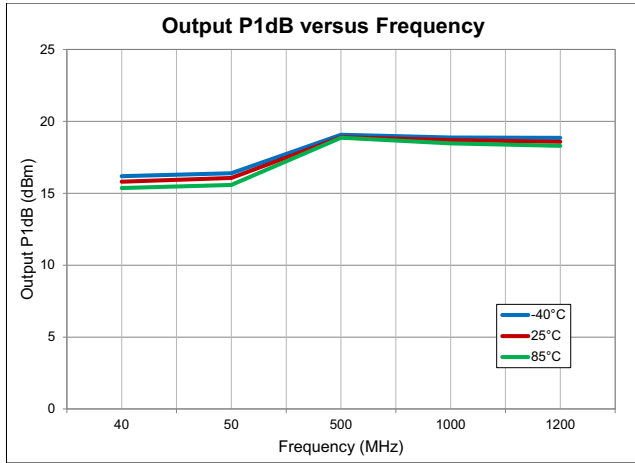

Multi-Carrier Composite Distortion Data (75Ω) at 26dBmV/CH

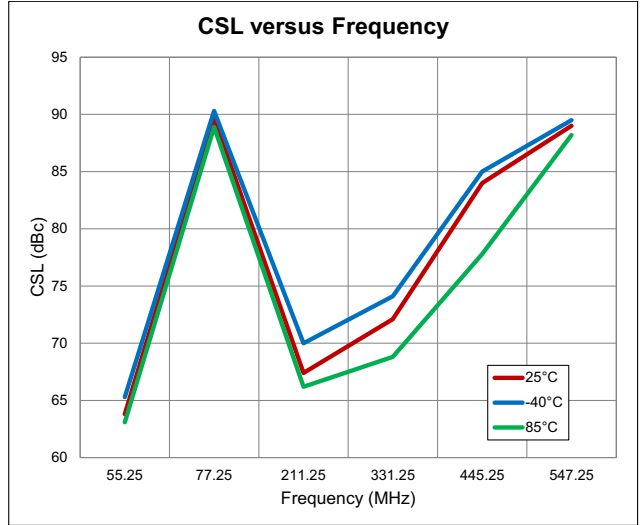
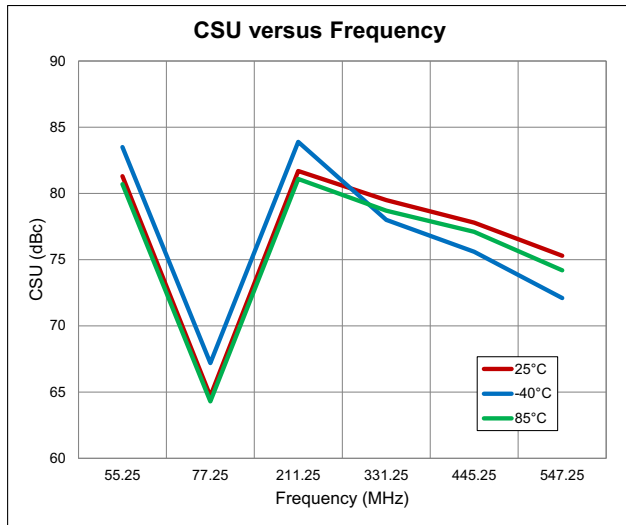
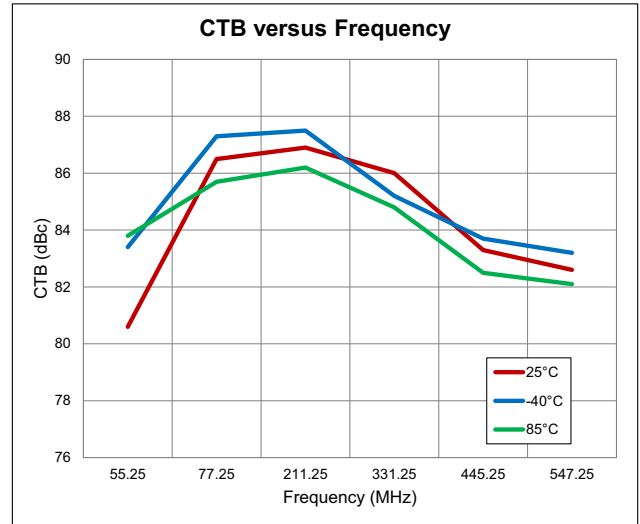
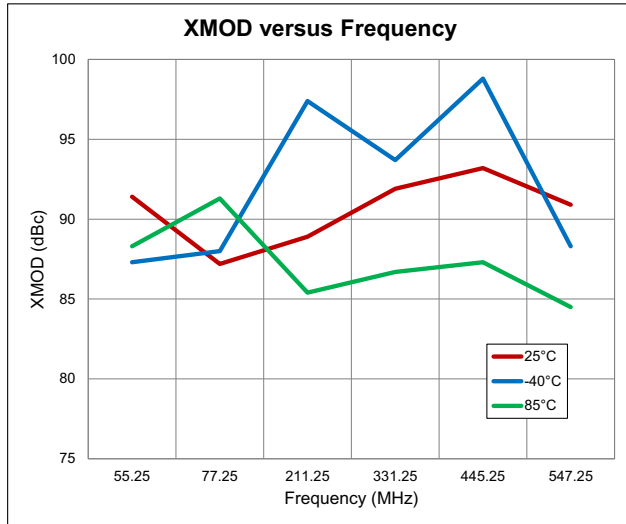

Evaluation Board Schematic

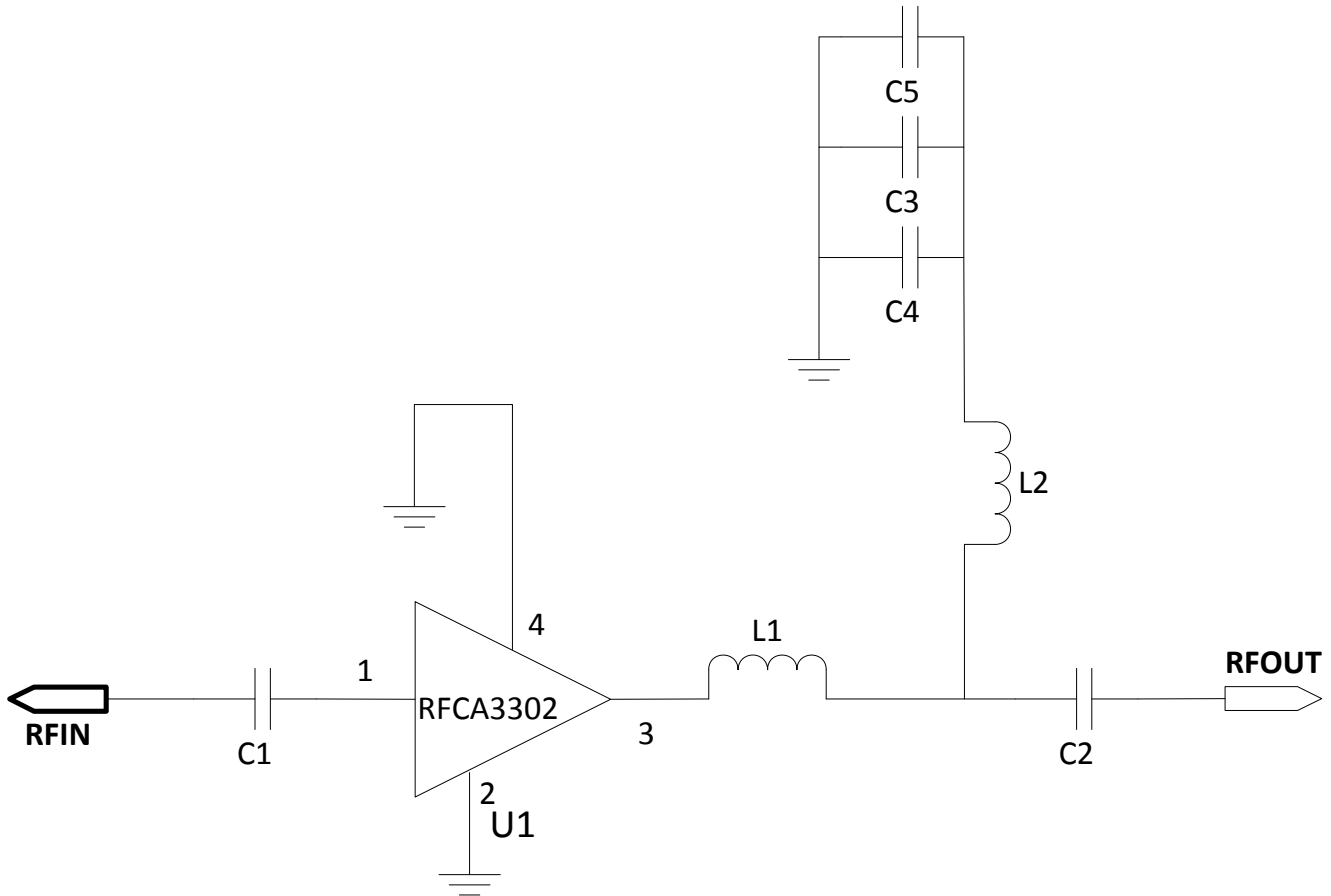

Evaluation Board Bill of Materials (BOM)

Description	Reference Designator	Manufacturer	Manufacturer's P/N
Evaluation Board			RFCA330x410(A)
CAP, 10000pF, 10%, 25V, X7R, 0402	C1-C3	Murata Electronics	GRM155R71E103KA01D
CAP, 100pF, 5%, 50V, COG, 0402	C4	Murata Electronics	GRM1555C1H101JA01D
CAP, 10μF, 10%, 10V, TANT-A	C5	AVX Corporation	TAJA106K010R
CONN, F, Edge Mount, 60 Mil	J1-J2	Trompeter Electronics, Inc	CBJE130-1
IND, 6.8nH, 5%, M/L, 0402	L1	Murata Electronics	LQG15HN6N8J02D
IND, 470nH, 5%, M/L, 0805	L2	Toko SH Waigaoqiao F.T.Z Inc.	LL2012-FR47J
DNI	L3	Taiyo Yuden (USA), Inc.	LG HK1005R12J-T
CONN, HDR,ST, PLRZD, 3-PIN, 0.100"	P1	ITW Pancon	MPSS100-3-C
DNI	R1		
DUT	U1	RFMD	RFMD

Pin Names and Descriptions

Pin	Name	Description
1	RFIN	RF input pin. This pin requires the use of an external DC-blocking capacitor chosen for the frequency of operation.
2	GND	Connection to ground. Use via holes for best performance to reduce lead inductance as close to ground leads as possible.
3	RFOUT/BIAS	RF output and bias pin. DC-voltage is present on this pin, therefore a DC-blocking capacitor is necessary for proper operation.
4	GND	Connection to ground. Use via holes for best performance to reduce lead inductance as close to ground leads as possible.

Evaluation Board Assembly Drawing

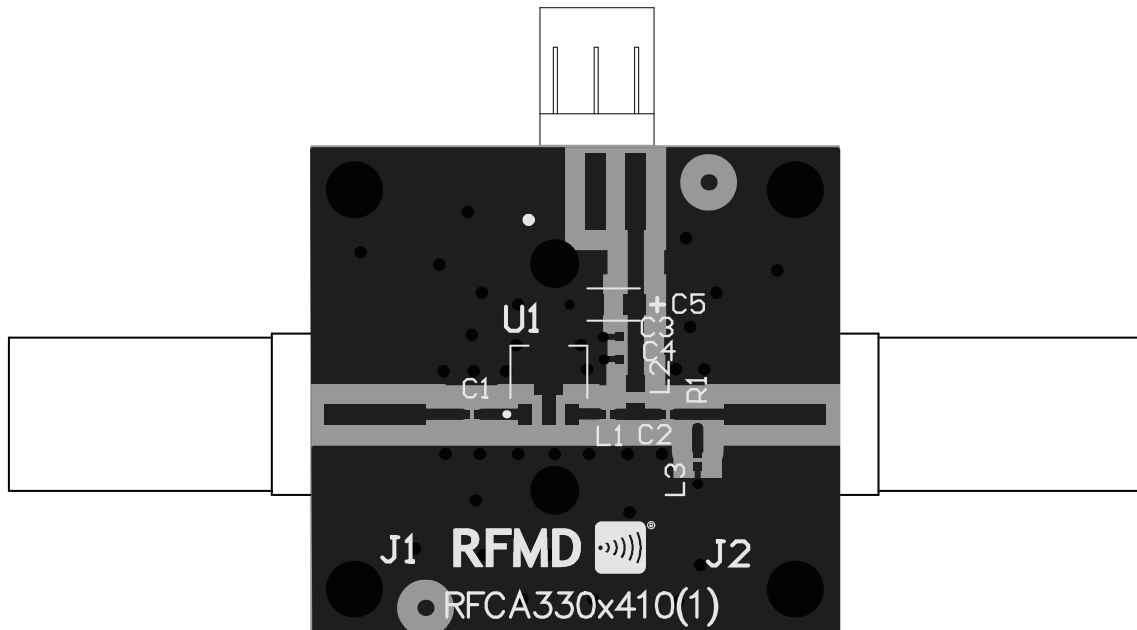

Package Drawing (Dimensions in Millimeters)

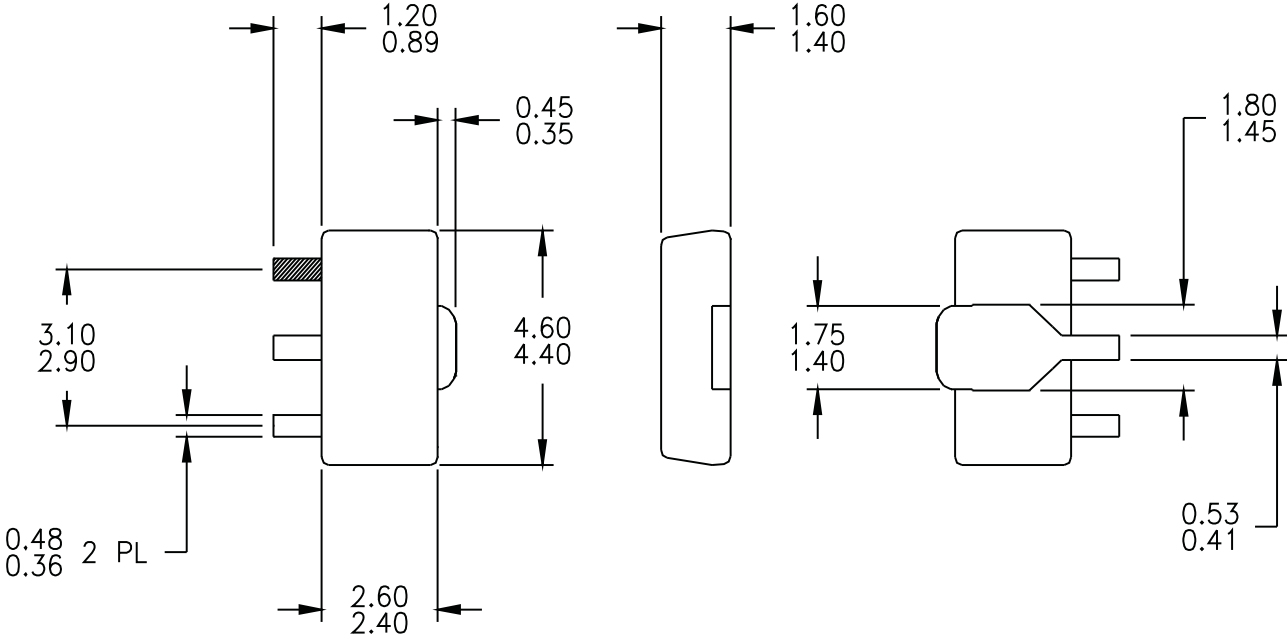

NOTE: SHADED LEAD IS PIN 1

Branding Diagram

