



### Features

- Frequency Range 700MHz to 1035MHz
- Full Internal Matching and No External Bias Inductors
- 6-Bit Digital Step Attenuator
- SPI Serial Control Programming
- Max Gain=32dB at 900MHz
- Gain Control Range=31.5dB (0.5dB Step Size)
- High OIP3/P1dB=+40/23dBm
- Single +5V Supply
- Small 28-Pin, 6.0mmx6.0mm, MCM
- Power-up Programming

### Applications

- Cellular, 3G Infrastructure
- WiBro, WiMax, LTE
- Microwave Radio
- High Linearity Power Control

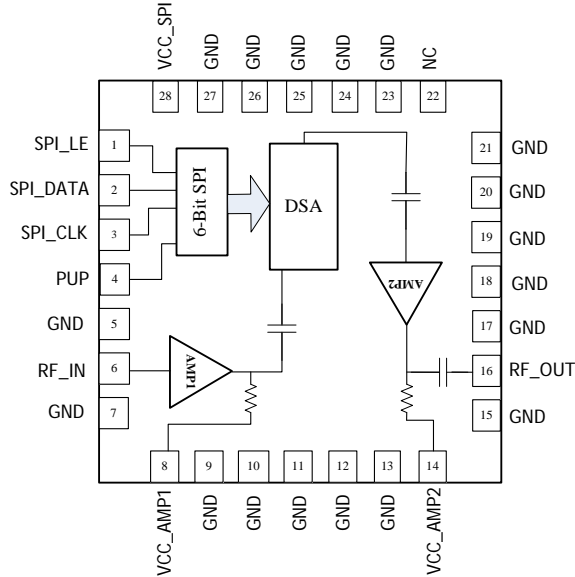

Functional Block Diagram

### Product Description

RFMD's RFDA0026 is a digital controlled variable gain amplifier featuring high linearity over the entire gain control range with noise figure less than 4.1dB in its maximum gain state. The gain of the 6-bit digital step attenuator is programmed with a serial mode control interface (SPI). The RFDA0026 is packaged in a small 6.0mmx6.0mm leadless laminate MCM, which contains plated through thermal vias for ultra low thermal resistance. This module is easy to use with no external matching components required.

### Ordering Information

RFDA0026SQ	Sample bag with 25 pieces
RFDA0026SR	7" Sample reel with 100 pieces
RFDA0026TR7	7" Reel with 750 pieces
RFDA0026TR13	13" Reel with 2500 pieces
RFDA0026PCK-410	800MHz to 1035MHz PCBA with 5-piece sample bag
RFDA0026PCK-411	650 MHz to 850MHz PCBA with 5-piece sample bag

### Optimum Technology Matching® Applied

- |   |                                      |  |                                    |
|---|--------------------------------------|--|------------------------------------|
| <input checked="" type="checkbox"/> GaAs HBT  | <input type="checkbox"/> SiGe BiCMOS | <input checked="" type="checkbox"/> GaAs pHEMT | <input type="checkbox"/> GaN HEMT  |
| <input type="checkbox"/> GaAs MESFET          | <input type="checkbox"/> Si BiCMOS   | <input checked="" type="checkbox"/> Si CMOS    | <input type="checkbox"/> BiFET HBT |
| <input checked="" type="checkbox"/> InGaP HBT | <input type="checkbox"/> SiGe HBT    | <input type="checkbox"/> Si BJT                | <input type="checkbox"/> LD MOS    |

RF MICRO DEVICES®, RFMD®, Optimum Technology Matching®, Enabling Wireless Connectivity™, PowerStar®, POLARIS™ TOTAL RADIO™ and UltimateBlue™ are trademarks of RFMD, LLC. BLUETOOTH is a trademark owned by Bluetooth SIG, Inc., U.S.A. and licensed for use by RFMD. All other trade names, trademarks and registered trademarks are the property of their respective owners. ©2011, RF Micro Devices, Inc.

## Absolute Maximum Ratings

Parameter	Rating	Unit
Supply Voltage ( $V_{CC}$ , $V_{DD}$ )	5.5	V
DC Supply Current	300	mA
Power Dissipation ( $P_{DISS}$ )	1500	mW
Max RF Input Power	12	dBm
Operating Temperature ( $T_{CASE}$ )	-40 to +85	°C
Storage Temperature	-40 to +150	°C
Junction Temperature ( $T_j$ )	170	°C
Human Body Model	1000 (Class 1C)	V
Moisture Sensitivity Level	MSL 3	

Note: MTTF=1.7E6 hours at 170°C junction temperature.



**Caution!** ESD sensitive device.

Exceeding any one or a combination of the Absolute Maximum Rating conditions may cause permanent damage to the device. Extended application of Absolute Maximum Rating conditions to the device may reduce device reliability. Specified typical performance or functional operation of the device under Absolute Maximum Rating conditions is not implied.

The information in this publication is believed to be accurate and reliable. However, no responsibility is assumed by RF Micro Devices, Inc. ("RFMD") for its use, nor for any infringement of patents, or other rights of third parties, resulting from its use. No license is granted by implication or otherwise under any patent or patent rights of RFMD. RFMD reserves the right to change component circuitry, recommended application circuitry and specifications at any time without prior notice.



RoHS (Restriction of Hazardous Substances): Compliant per EU Directive 2002/95/EC.

Parameter	Specification			Unit	Condition
	Min.	Typ.	Max.		
<b>Overall</b>					Temp=25°C, $V_{CC}=V_{DD}=5V$ , standard application circuit
Frequency Range	700		1035	MHz	
Max Gain		32		dB	Attenuation = 0dB
Gain Control Range		31.5		dB	
Step Accuracy	±(0.1 +5% attenuation setting)			dB	Major state error up to 1035MHz
P1dB		23.8		dBm	Attenuation = 0dB
Output IP3		40		dBm	$P_{OUT}=5dBm$ /tone, 1MHz spacing
Control Interface		6		bit	SPI interface
Settling Time		250		ns	tON, tOFF (10%/90% RF)
Noise Figure		4.1		dB	Attenuation = 0dB
Impedance		50		Ω	
Input Return Loss		-15		dB	
Output Return Loss		-11		dB	
Total Supply Voltage	4.75	5.0	5.25	V	
Supply Current		192		mA	From $V_{CC\_SPI}$ , $V_{CC\_AMP1}$ and $V_{CC\_AMP2}$
Thermal Resistance		46.2		°C/W	Junction to backside of device

## Typical RF Performance at Key Operating Frequencies

Parameter	Unit	700MHz <sup>2</sup>	850MHz	900MHz	970MHz	1040MHz
Max Small Signal Gain	dB	34.1	33.4	33.2	33.0	32.5
Output P1dB	dBm	24.0	23.8	23.8	23.7	23.7
Output IP3 <sup>1</sup>	dBm	40.7	39.4	40.2	41.1	41.6
Input Return Loss	dB	-13.2	-15.7	-17.1	-18.6	-19.8
Output Return Loss	dB	-12	-10.1	-10.3	-10.2	-10.1
Noise Figure	dB	4.0	4.0	4.1	4.0	4.1

Notes:

- OIP3 is tested at  $P_{OUT}=+5dBm$ /Tone and 1 MHz spacing
- Based on 650MHz to 850MHz Application Circuit

**Typical Performance - 800MHz to 1035MHz Broadband Application Circuit**

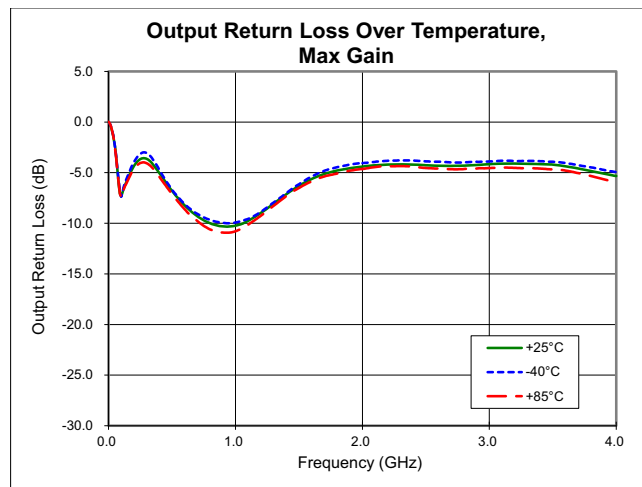
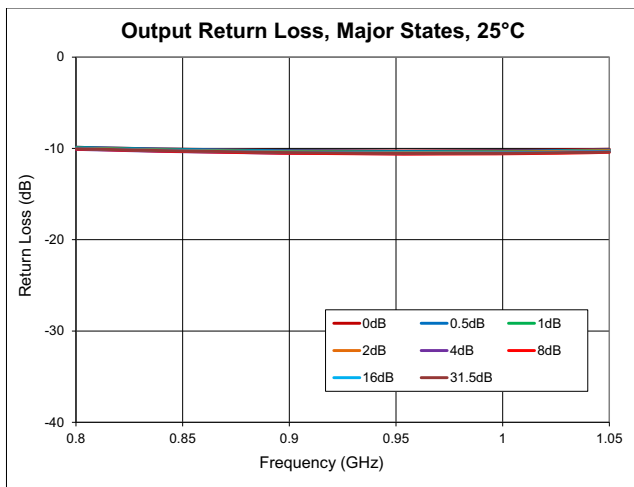
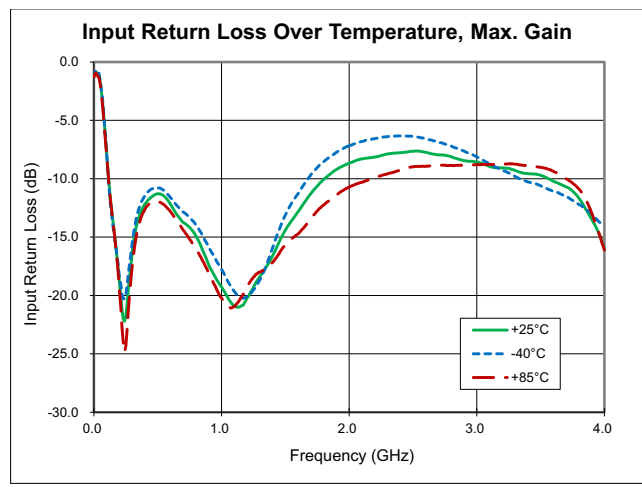
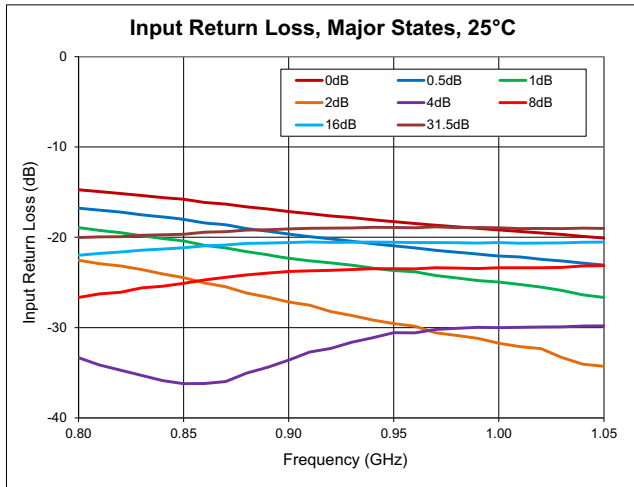
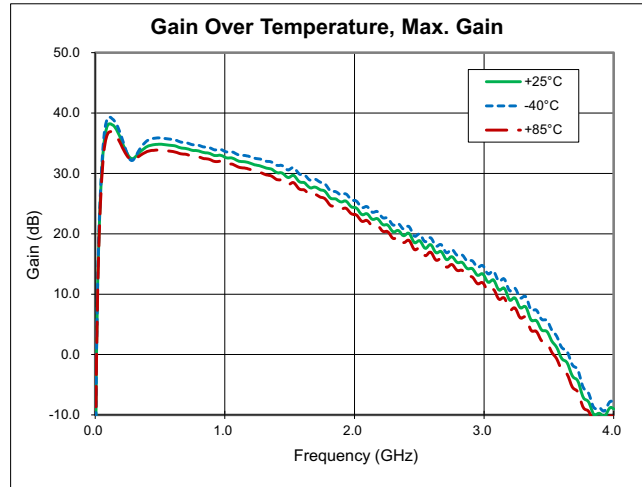
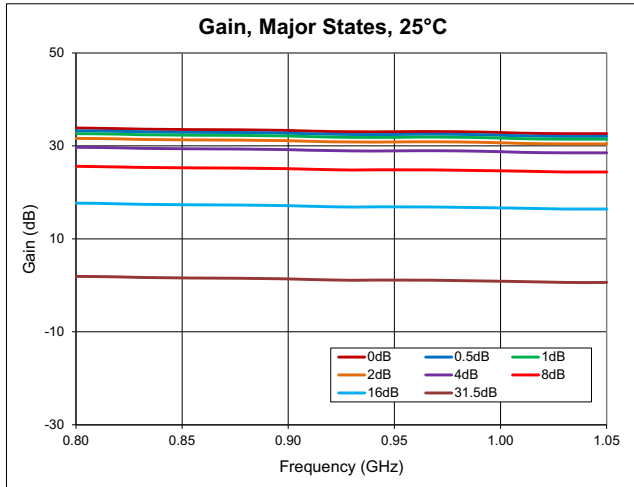

## Typical Performance - 800MHz to 1035MHz Broadband Application Circuit

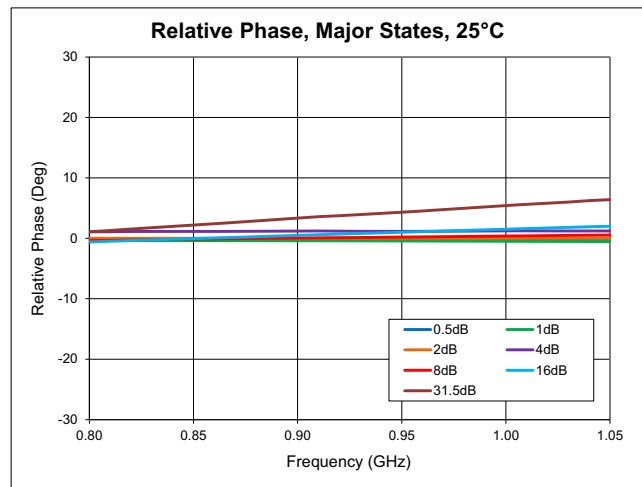
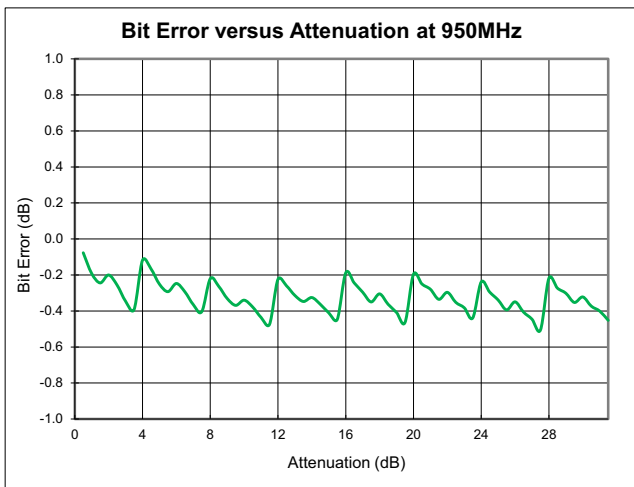
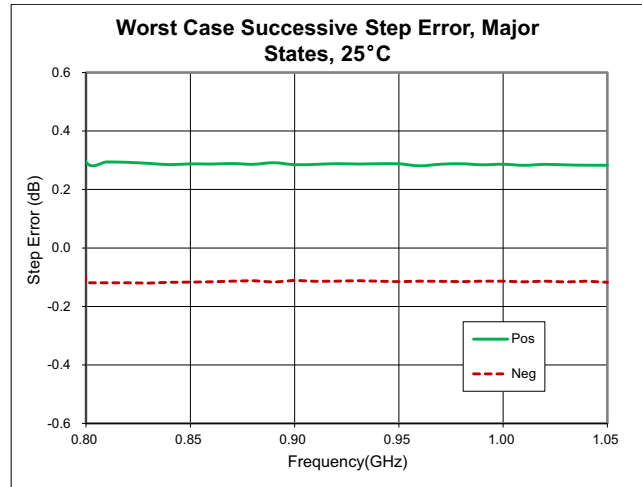
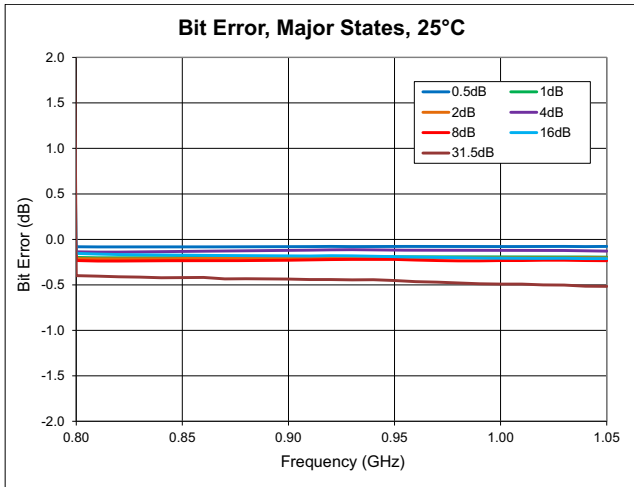
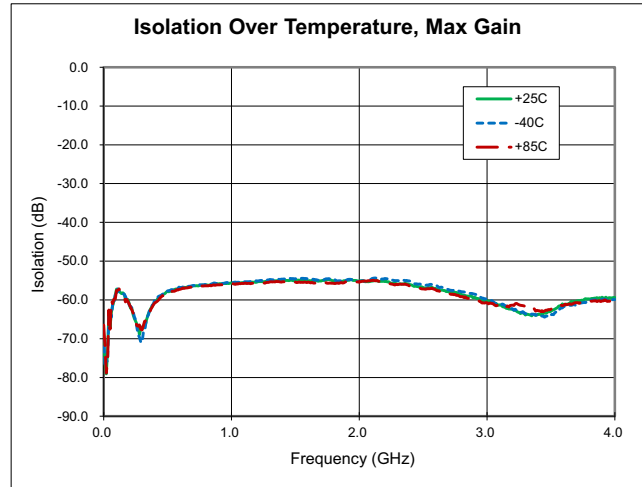
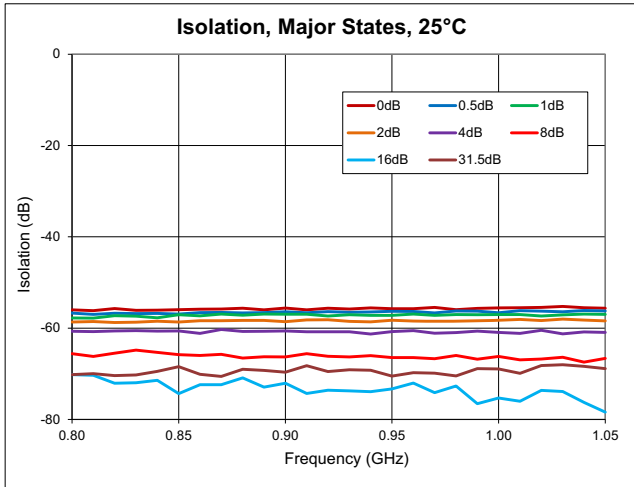

**Typical Performance - 800MHz to 1035MHz Broadband Application Circuit**

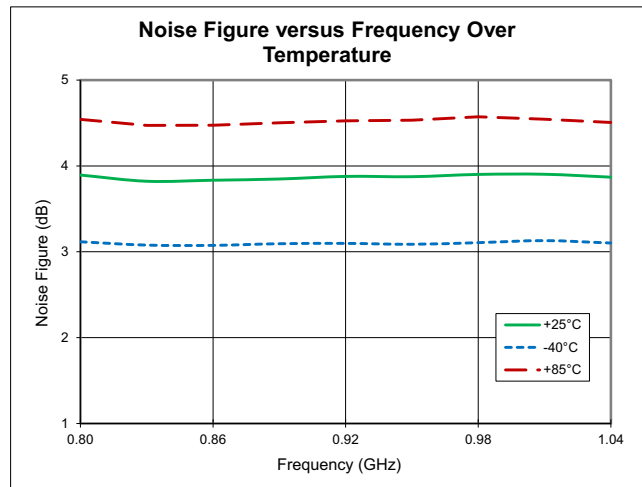
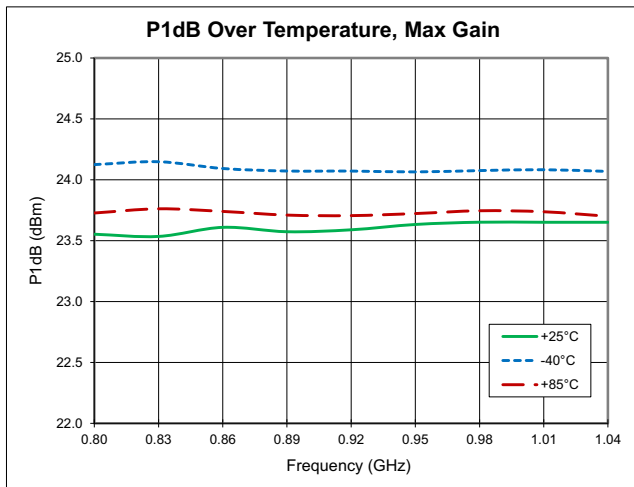
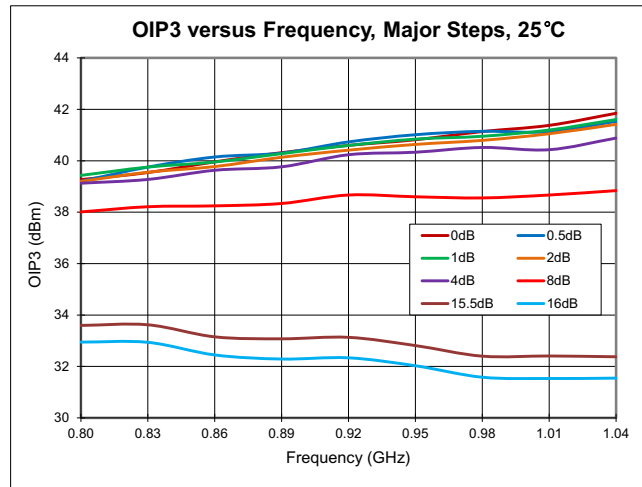
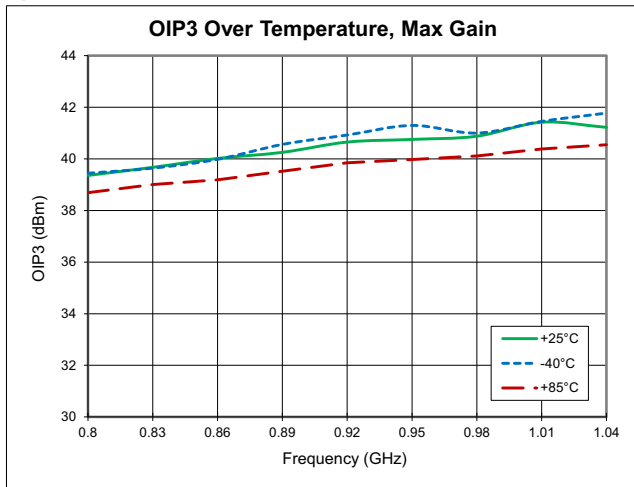

## Typical Performance - 650MHz to 850MHz Broadband Application Circuit

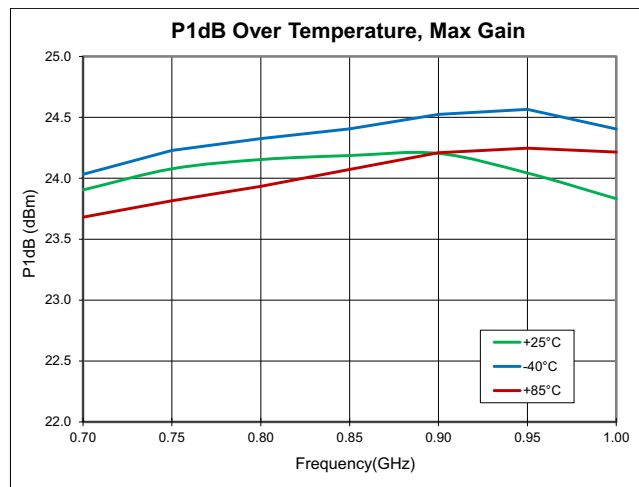
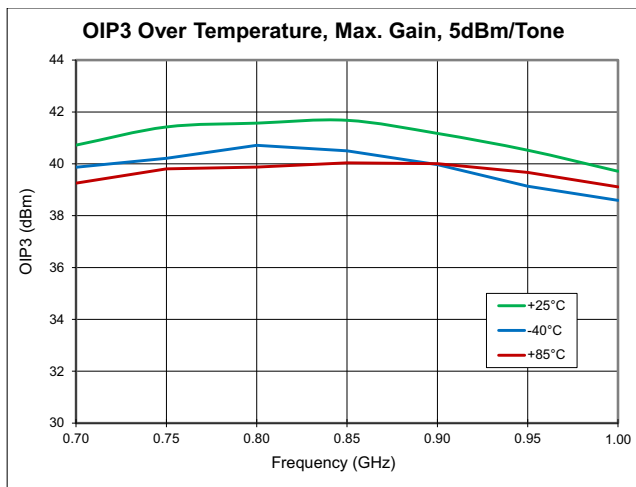
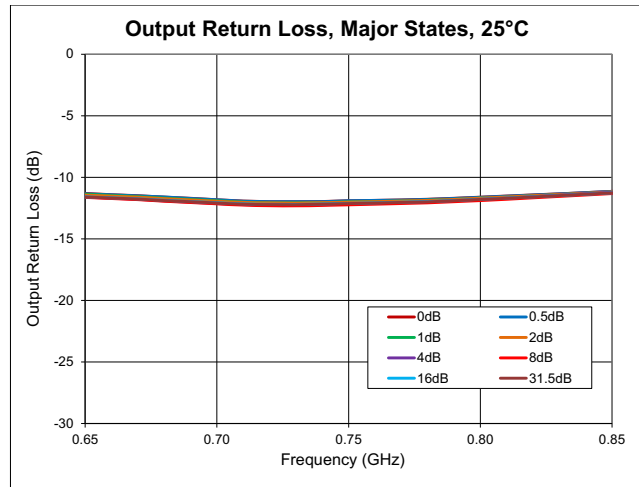
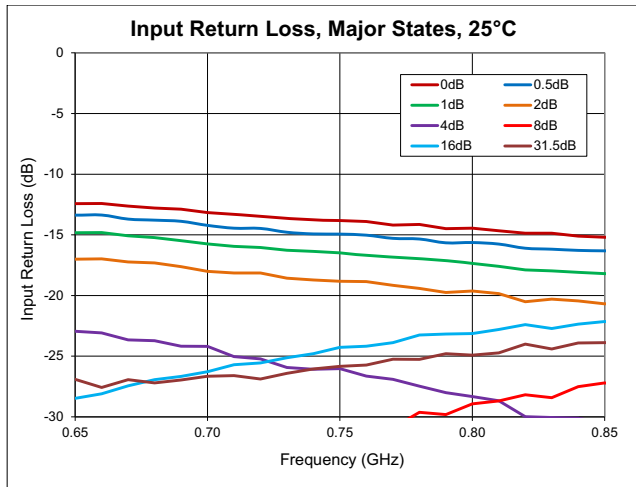
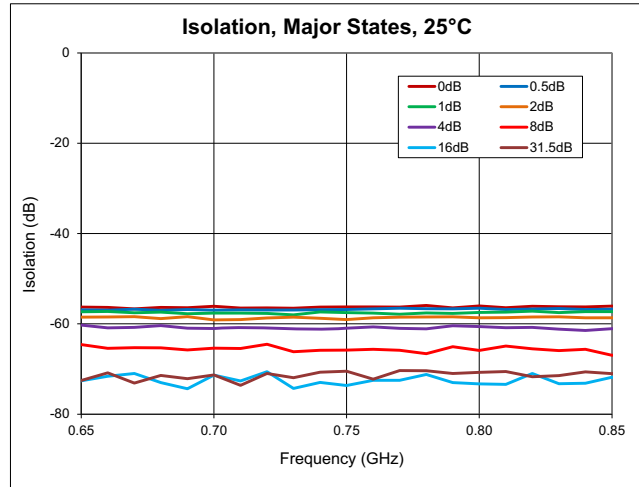
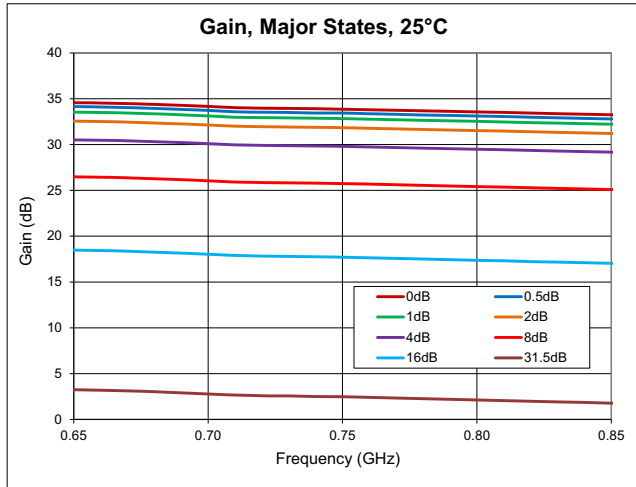

**Truth Table**

Control Bit						Gain Relative to Maximum Gain
D5	D4	D3	D2	D1	D0	
1	1	1	1	1	1	0dB
1	1	1	1	1	0	-0.5dB
1	1	1	1	0	1	-1dB
1	1	1	0	1	1	-2dB
1	1	0	1	1	1	-4dB
1	0	1	1	1	1	-8dB
0	1	1	1	1	1	-16dB
0	0	0	0	0	0	-31.5dB

**Serial Port Interface**

**SPI Timing Diagram**

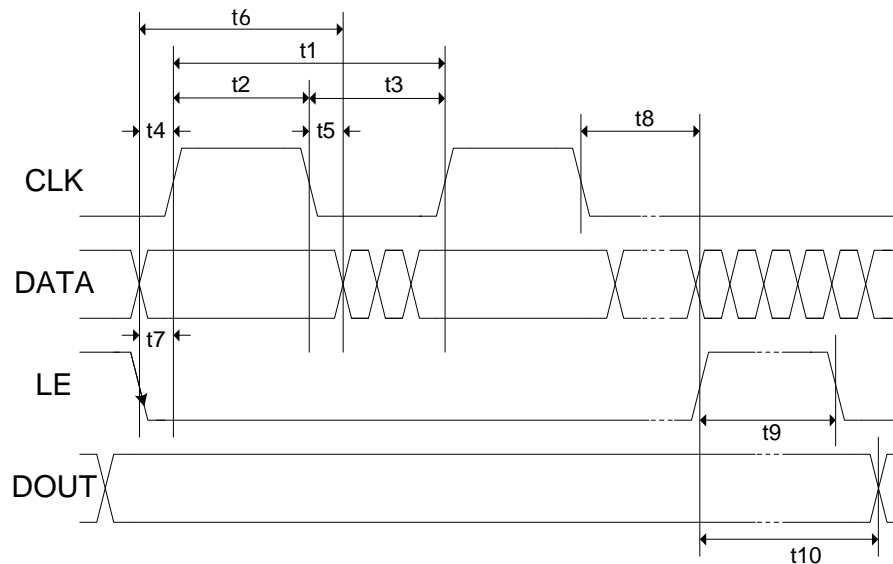

**Programming example – 6-Bit**

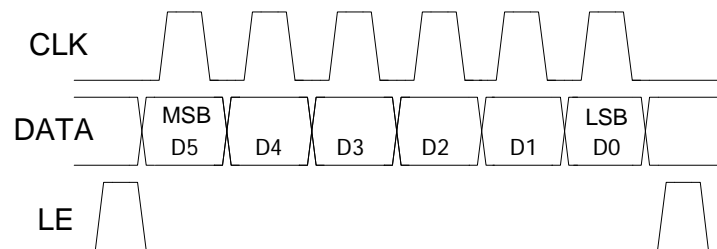

### Specifications – SPI Timing Diagram

Parameter	Limit	Unit	Comment
t1	25	MHz max	CLK Frequency
t2	20	ns min	CLK High
t3	20	ns min	CLK Low
t4	5	ns min	DATA to CLK Setup Time
t5	5	ns min	DATA to CLK Hold Time
t6	30	ns min	DATA Valid
t7	5	ns min	LE to CLK Setup Time
t8	5	ns min	CLK to LE Setup Time
t9	10	ns min	LE Pulse Width
t10	20	ns max	Output Set

State	Logic
Low	0V to 0.8V
High	2.0 to 5.0V

PUP	Attenuator Setting
Low	Attenuation at Min, 0dB
High	Attenuation at Max, 31.5dB



### Pin Names and Description

Pin	Function	Description
1	SPI_LE	Serial Latch Enable Input
2	SPI_DATA	Serial Data Input
3	SPI_CLK	Serial Clock Input
4	PUP	Power-up Programming Pin
5	GND	RF/DC Ground Connection
6	RF_IN	RF Input
7	GND	RF/DC Ground Connection
8	VCC_AMP1	Supply Voltage for Amplifier 1
9	GND	RF/DC Ground Connection
10	GND	RF/DC Ground Connection
11	GND	RF/DC Ground Connection
12	GND	RF/DC Ground Connection
13	GND	RF/DC Ground Connection
14	VCC_AMP2	Supply Voltage for Amplifier 2
15	GND	RF/DC Ground Connection
16	RF_OUT	RF Output
17	GND	RF/DC Ground Connection
18	GND	RF/DC Ground Connection
19	GND	RF/DC Ground Connection
20	GND	RF/DC Ground Connection
21	GND	RF/DC Ground Connection
22	NC	Do Not Connect, Leave Open Circuit
23	GND	RF/DC Ground Connection
24	GND	RF/DC Ground Connection
25	GND	RF/DC Ground Connection
26	GND	RF/DC Ground Connection
27	GND	RF/DC Ground Connection
28	VCC_SPI	Supply Voltage for SPI and DSA Chip

## Evaluation Board Schematic 800MHz to 1035MHz Application Circuit

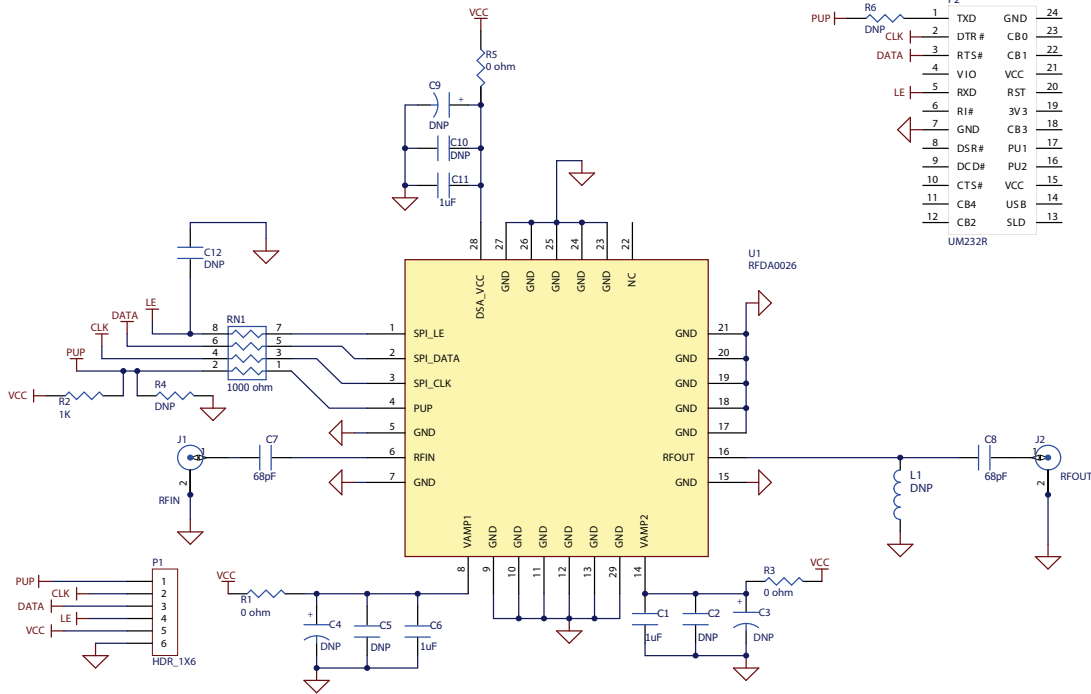

## Evaluation Board Build of Materials (BOM) 800MHz to 1035MHz Application Circuit

Description	Reference Designator	Manufacturer	Manufacturer's P/N
RFDA0026, 6 X 6sq. mm, 28-Pin Laminate	U1	RFMD	RFDA0026SB
RFDA2026-411(B)		Viasystems	RFDA2026-411(B)
CONN, SMA, END LNCH, FLT, 0.062"	J1-J2	Emerson Network Power	142-0701-821
CONN, HDR, ST, PLRZD, 6-PIN, 0.100"	P1	AMP	640454-6
CONN, SKT, 24-PIN DIP, .600", T/H	P2	Aries Electronics, Inc.	24-6518-10
CAP, 1μF, 10%, 10V, X5R, 0402	C1, C6, C11	Murata Electronics	GRM155R61A105KE15D
CAP, 68pF, 5%, 50V, COG, 0402	C7-C8	Murata Electronics	GRM1555C1H680JZ01D
RES, 1K, 5%, 1/16W, 0603	R2	Panasonic Industrial Co.	ERJ-3GEYJ102
RES ARRAY, 4-ELEM, 1K, 5%, SMD 4 X 00402	RN1	KOA	CN1E4KTTD102J
RES, 0Ω, 0603	R1, R3, R5	KOA Speer Electronics, Inc.	RK73Z1JLTD
DNP	C2, C5, C10	N/A	N/A
DNP	C3-C4, C9, C12	N/A	N/A
DNP	R4, R6	N/A	N/A
DNP	L1	N/A	N/A

## Evaluation Board Schematic 650MHz to 850MHz Application Circuit

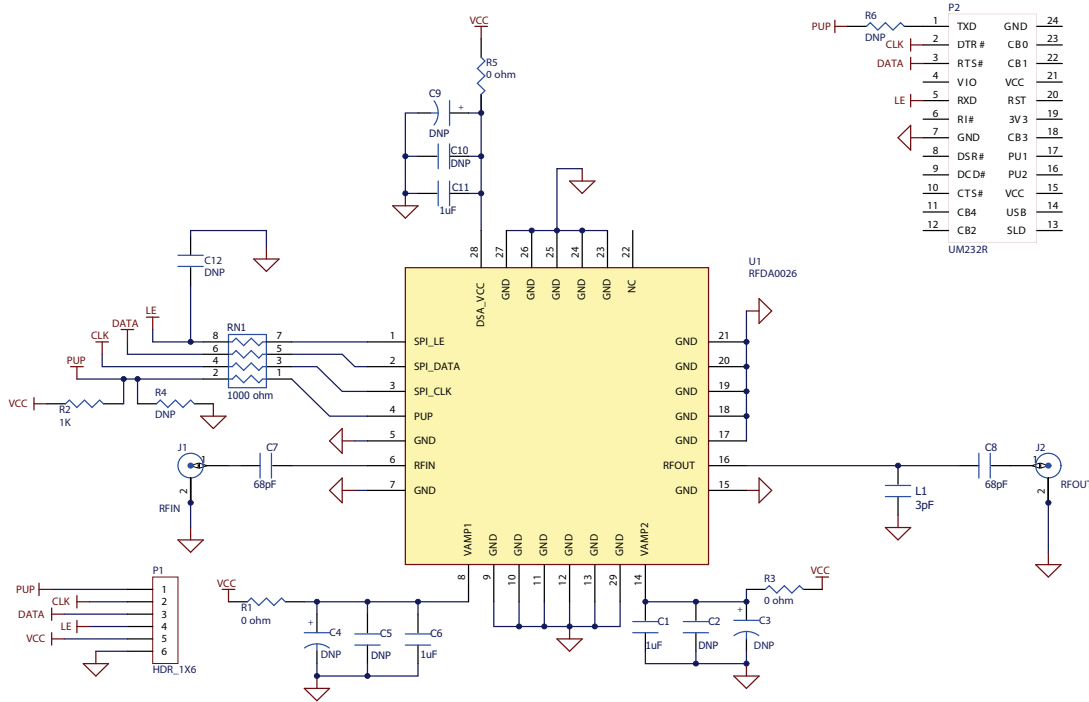

## Evaluation Board Build of Materials (BOM) 650MHz to 850MHz Application Circuit

Description	Reference Designator	Manufacturer	Manufacturer's P/N
RFDA0026, 6 x 6sq.mm, 28-Pin Laminate	U1	RFMD	RFDA0026SB
RFDA2026-411(B)		Viasystems	RFDA2026-411(B)
CONN, SMA, END LNCH, FLT, 0.062"	J1-J2	Emerson Network Power	142-0701-821
CONN, HDR, ST, PLRZD, 6-PIN, 0.100"	P1	AMP	640454-6
CONN, SKT, 24-PIN DIP, .600", T/H	P2	Aries Electronics, Inc.	24-6518-10
CAP, 1μF, 10%, 10V, X5R, 0402	C1, C6, C11	Murata Electronics	GRM155R61A105KE15D
CAP, 68pF, 5%, 50V, COG, 0402	C7-C8	Murata Electronics	GRM1555C1H680JZ01D
RES, 1K, 5%, 1/16W, 0603	R2	Panasonic Industrial Co.	ERJ-3GEYJ102
RES ARRAY, 4-ELEM, 1K, 5%, SMD 4 X 00402	RN1	KOA	CN1E4KTTD102J
CAP, 3pF, +/-0.1pF, 250V, HI-Q, 0603	L1	Murata Electronics	GQM1875C2E3R0BB12D
RES, 0Ω, 0603	R1, R3, R5	KOA Speer Electronics, Inc.	RK73Z1JLTD
DNP	C2, C5, C10	N/A	N/A
DNP	C3-C4, C9, C12	N/A	N/A
DNP	R4, R6	N/A	N/A

## Evaluation Board Assembly Drawing

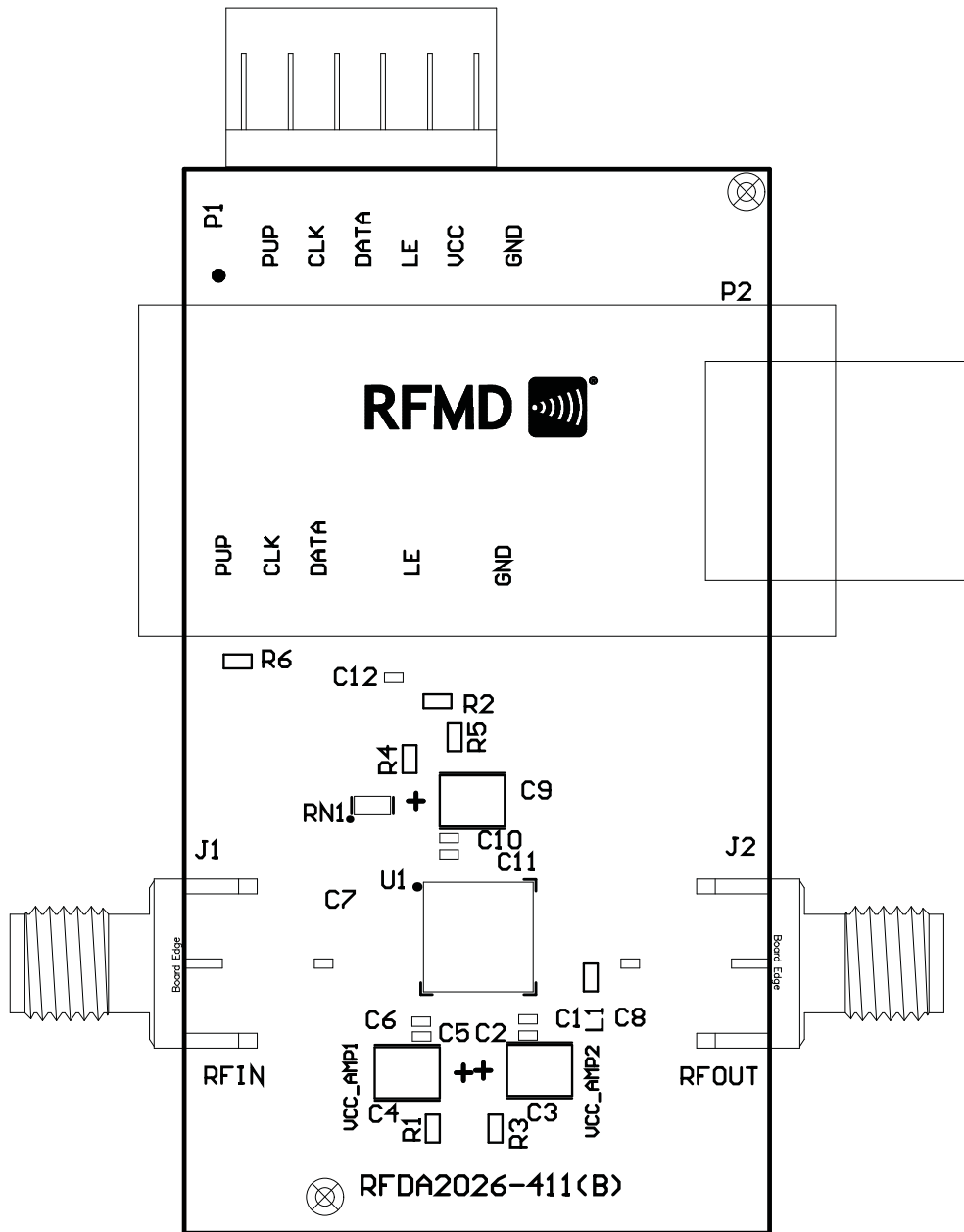

**Package Drawing**  
6.0mmx6.0mm Laminate Module

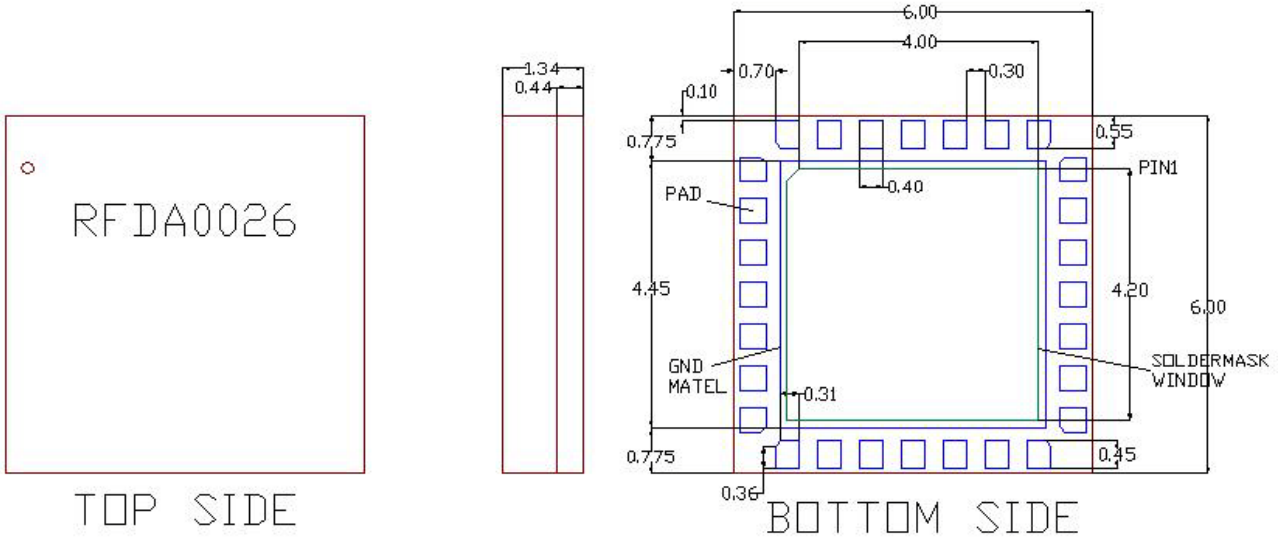

The module thickness tolerance is: +/- .04mm. All other dim tolerances are +/- .075mm unless otherwise noted.

**Branding Diagram**

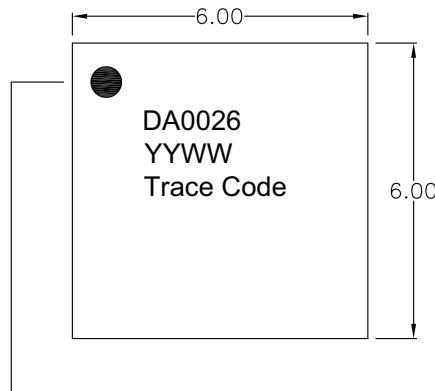

Pin 1 Indicator

Fill in the YYWW Notation with the Date Code

YY = Year

WW = Week

Trace Code to be assigned by SubCon