



### Features

- Frequency Range 5MHz to 1GHz
- Dual 6-Bit Digital Step Attenuator
- SPI Serial Control Programming
- Max Gain=45dB at 100MHz
- Gain Control Range=63dB (0.5dB Step Size)
- High OIP3/P1dB= +39/22dBm
- +5V Supply for DSA and +8V for Amplifier with Drop Resistor
- Small 28-Pin, 6.0mmx6.0mm, MCM
- Power-up Programming

### Applications

- High Linearity Power Control
- CATV Drivers
- Transceiver IF DVA
- Cellular, PCS, GSM, UMTS
- Wireless Data, Satellite Terminals

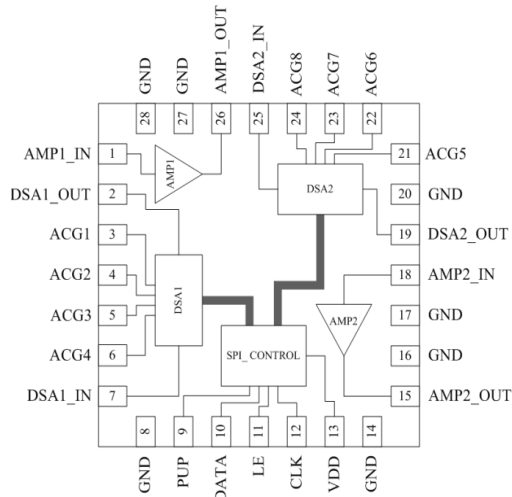

Functional Block Diagram

### Product Description

RFMD's RFDA0066 is a digital controlled variable gain amplifier featuring high linearity over the entire gain control range with noise figure less than 3.5dB in its maximum gain state. The gain of dual 6-bit digital step attenuator is programmed with a 12-bit Serial Peripheral Interface (SPI). The RFDA0066 is packaged in a small 6.0mm x 6.0mm leadless laminate MCM, which contains plated through thermal vias for ultra-low thermal resistance. The module is easy to use with a few external DC blocks and RF chokes.

### Ordering Information

RFDA0066SR	7" Sample reel with 100 pieces
RFDA0066SQ	Sample bag with 25 pieces
RFDA0066TR7	7" Reel with 750 pieces
RFDA0066TR13	13" Reel with 2500 pieces
RFDA0066PCK-410	5MHz to 250MHz PCBA with 5-piece sample bag

### Optimum Technology Matching® Applied

<input type="checkbox"/> GaAs HBT	<input type="checkbox"/> SiGe BiCMOS	<input checked="" type="checkbox"/> GaAs pHEMT	<input type="checkbox"/> GaN HEMT
<input type="checkbox"/> GaAs MESFET	<input type="checkbox"/> Si BiCMOS	<input checked="" type="checkbox"/> Si CMOS	<input type="checkbox"/> BIFET HBT
<input type="checkbox"/> InGaP HBT	<input checked="" type="checkbox"/> SiGe HBT	<input type="checkbox"/> Si BJT	<input type="checkbox"/> LDMOS

## Absolute Maximum Ratings

Parameter	Rating	Unit
Power Supply for DSA	+5.5V/20	V <sub>DC</sub> /mA
Power Supply for Amplifier	+5.5V/340	V <sub>DC</sub> /mA
Power Dissipation	1980	mW
Max RF Input Power, Z <sub>L</sub> =50 Ω	+16	dBm
Operating Temperature (T <sub>CASE</sub> )	-40 to +85	°C
Storage Temperature	-40 to +150	°C
Junction Temperature	+150	°C
ESD Rating (HBM)	500 (Class 1B)	V
Moisture Sensitivity Level	MSL3	



**Caution!** ESD sensitive device.

Exceeding any one or a combination of the Absolute Maximum Rating conditions may cause permanent damage to the device. Extended application of Absolute Maximum Rating conditions to the device may reduce device reliability. Specified typical performance or functional operation of the device under Absolute Maximum Rating conditions is not implied.

RoHS status based on EU Directive 2011/65/EU (at time of this document revision).

The information in this publication is believed to be accurate and reliable. However, no responsibility is assumed by RF Micro Devices, Inc. ("RFMD") for its use, nor for any infringement of patents, or other rights of third parties, resulting from its use. No license is granted by implication or otherwise under any patent or patent rights of RFMD. RFMD reserves the right to change component circuitry, recommended application circuitry and specifications at any time without prior notice.



RFMD Green: RoHS compliant per EU Directive 2011/65/EU, halogen free per IEC 61249-2-21, < 1000 ppm each of antimony trioxide in polymeric materials and red phosphorus as a flame retardant, and <2% antimony in solder.

Parameter	Specification			Unit	Condition
	Min.	Typ.	Max.		
<b>Overall</b>					T <sub>I</sub> =25 °C, Z <sub>S</sub> =Z <sub>L</sub> =50Ω, V <sub>CC</sub> =8V (for AMPs) and V <sub>DD</sub> =5V (for DSAs), 5MHz to 250MHz application circuit unless otherwise noted.
Frequency Range	5		1000	MHz	
Max Gain		44.5		dB	Attenuation=0dB
Gain Control Range		63.0		dB	
Step Accuracy	±(0.1 +5% attenuation setting)			dB	Major state error up to 250MHz
P1dB		22		dBm	Attenuation = 0dB
Output IP3		39		dBm	P <sub>OUT</sub> = 0dBm/tone, 1MHz spacing
Control Interface		12		bit	SPI Interface
Settling Time		250		ns	T <sub>ON</sub> , T <sub>OFF</sub> (10%/90% RF)
Noise Figure		3.5		dB	Attenuation = 0dB
Impedance		50		Ω	
Input Return Loss		20		dB	At Maximum Gain
Output Return Loss		20		dB	At Maximum Gain
DSA Supply Voltage	4.75	5.0	5.25	V	
DSA Supply Current	6	12	20	mA	Include Two DSAs and SPI Control Circuit
Amplifier Supply Voltage	4.7	5.0	5.3	V	Test on Amplifier Bias Pin
Amplifier Supply Current		230		mA	Include Two Amplifiers
Thermal Resistance		70		°C/W	

## Typical RF Performance at Key Operating Frequencies

Parameter	Unit	5MHz	50MHz	100MHz	250MHz	400MHz	600MHz	900MHz
Max Small Signal Gain	dB	44.3	44.5	44.5	44.0	43.3	42.4	40.3
Output P1dB	dBm	22.2	22.4	22.5	22.4	22.2	22.1	21.8
Output IP3	dBm	38.2	39.5	39.6	38.5	38.2	36.6	35.9
Input Return Loss	dB	23	25	25	21	23	23	28
Output Return Loss	dB	24	27	28	24	19	18	19
Noise Figure <sup>1</sup>	dB	N/A	3.5	3.5	3.5	3.7	3.7	3.8

Notes:

1. Noise Figure at 5MHz is not tested due to the limitation of test bench.

## Typical Performance - 5MHz to 250MHz Broadband Application Circuit

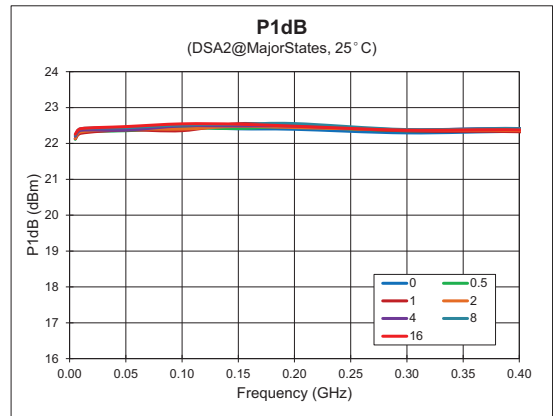
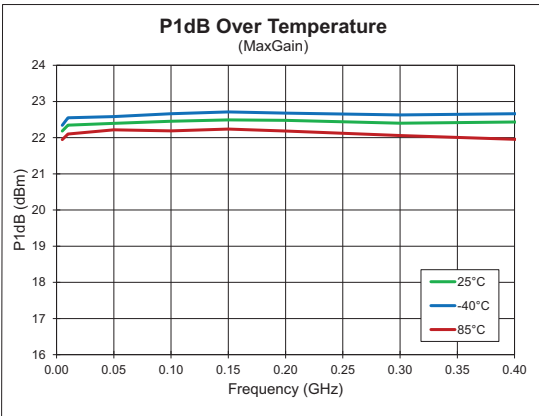
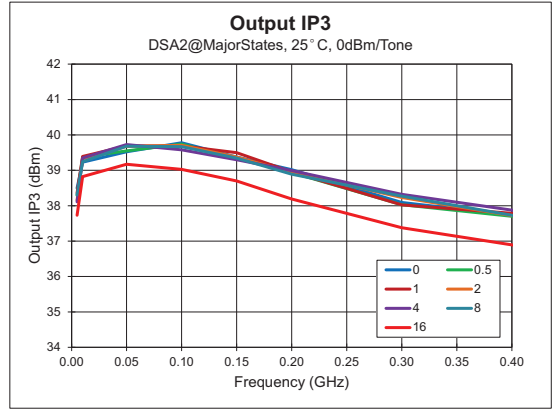
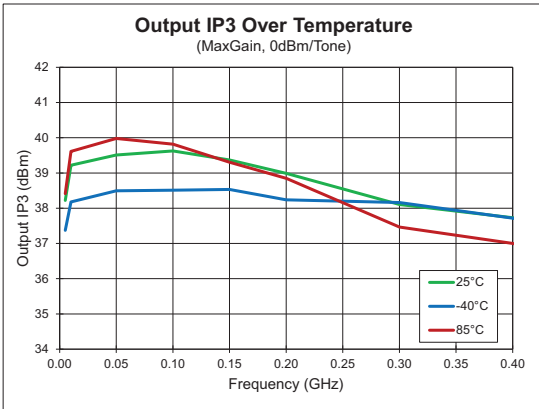
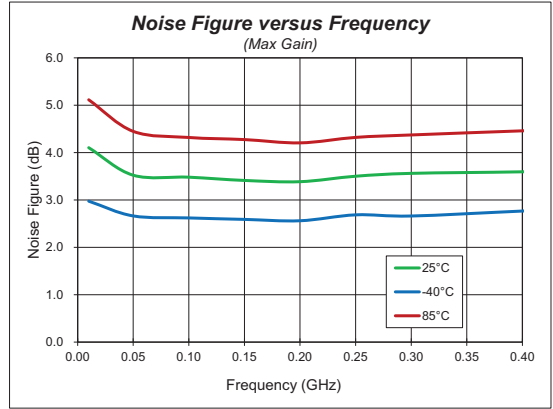
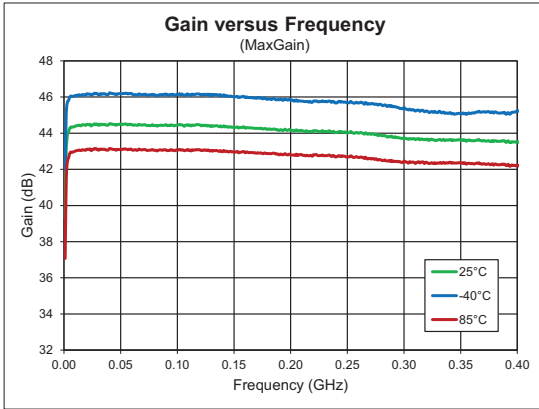

## Test Conditions: Changing DSA1 setting, with DSA2 at 0dB Attenuation (25 ° C)

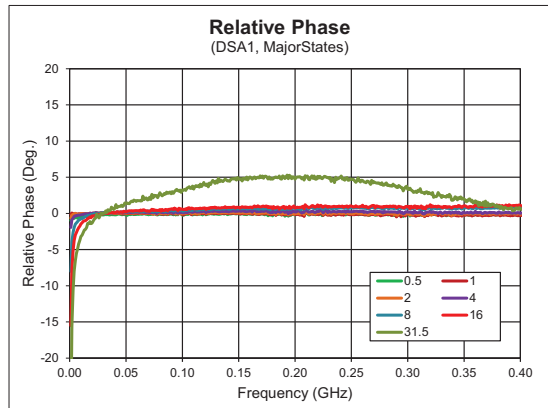
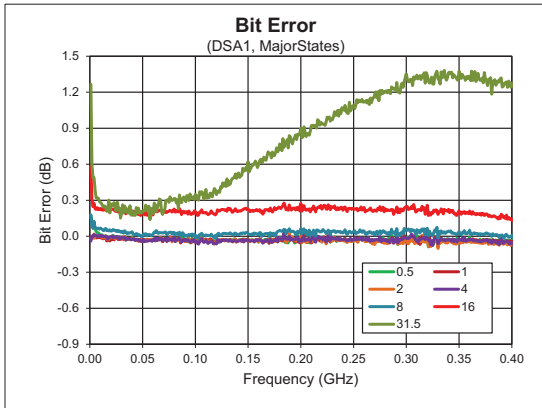
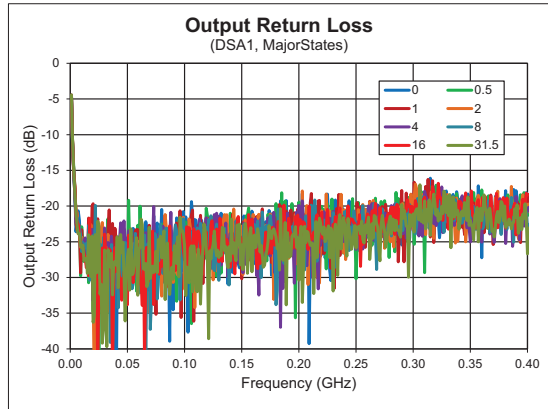
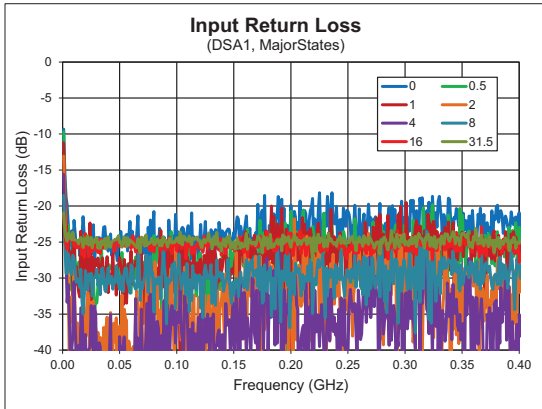

## Test Conditions: Changing DSA2 setting, with DSA1 at 0dB Attenuation (25 °C)

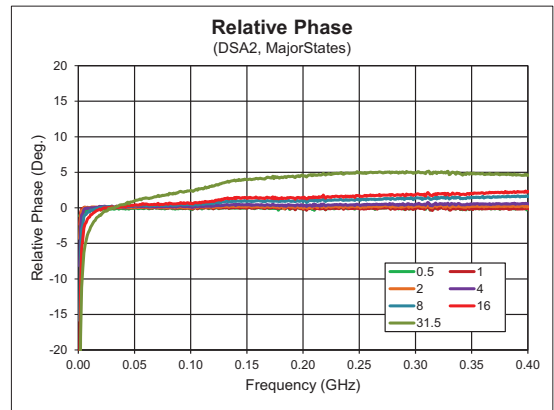
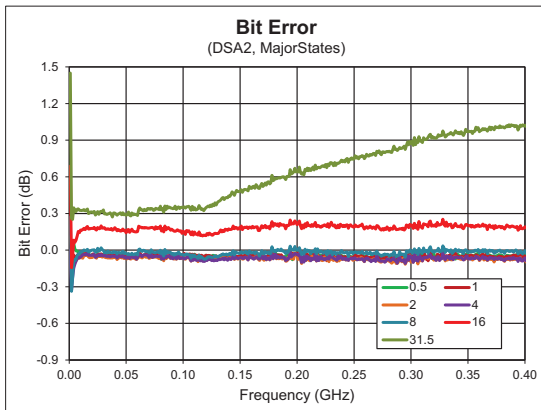
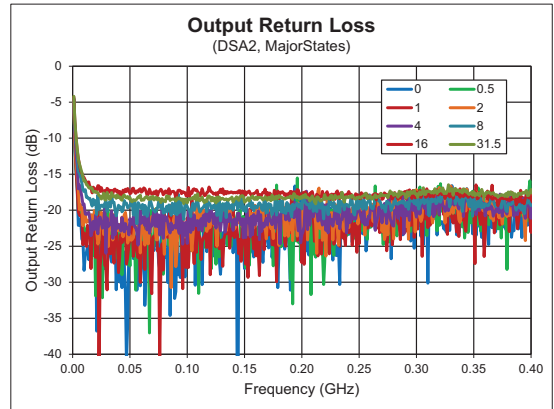
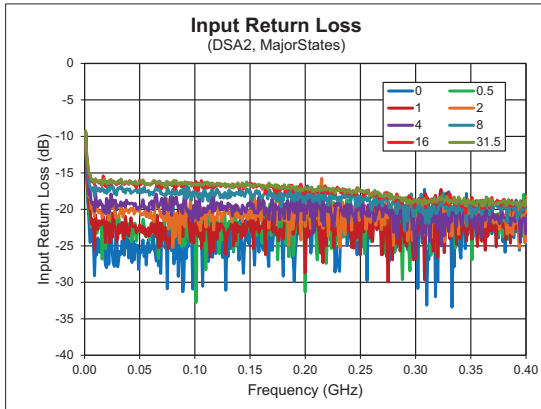

## Typical Performance - 400MHz to 1GHz Broadband Application Circuit

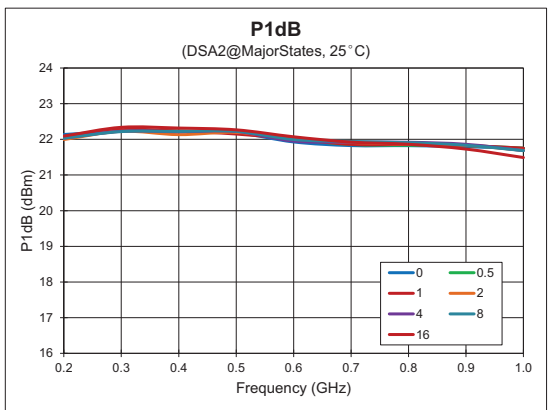
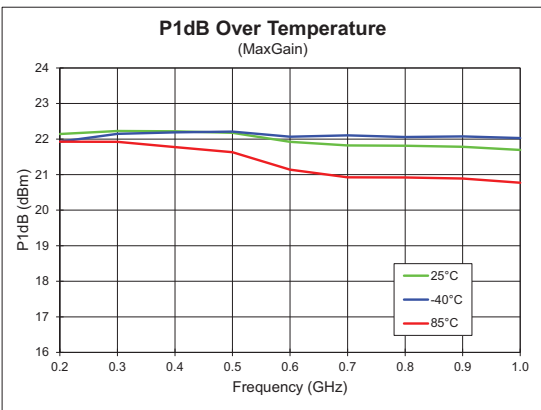
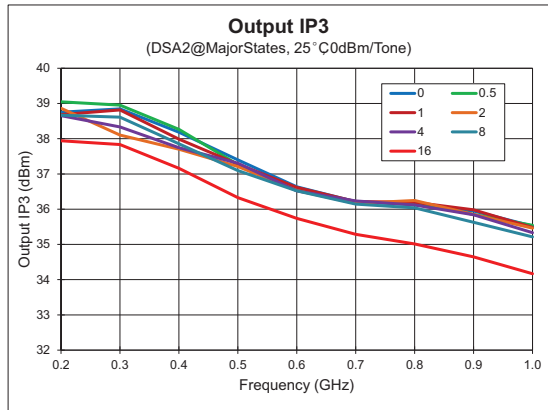
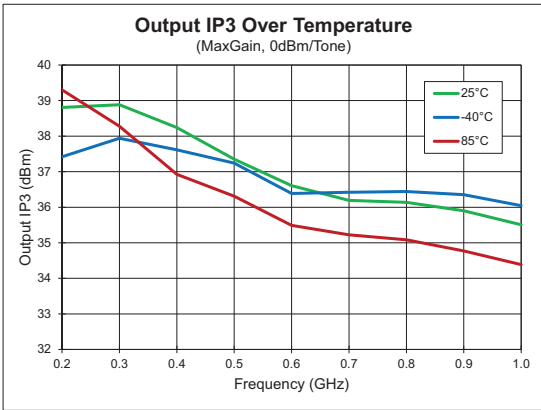
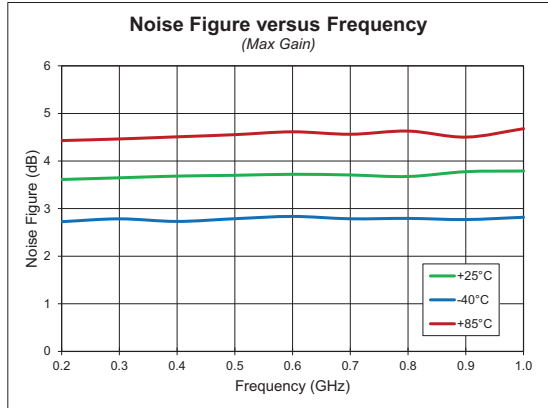
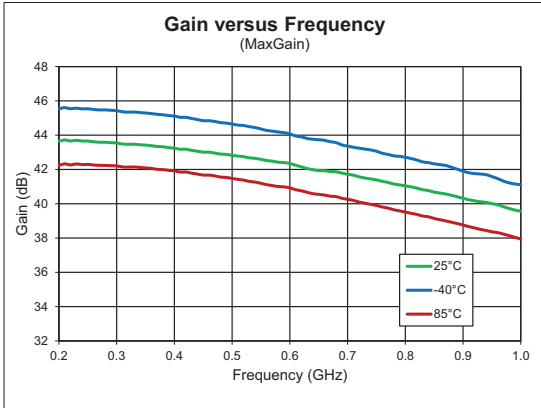

## Test Conditions: Changing DSA1 setting, with DSA2 at 0dB Attenuation (25 °C)

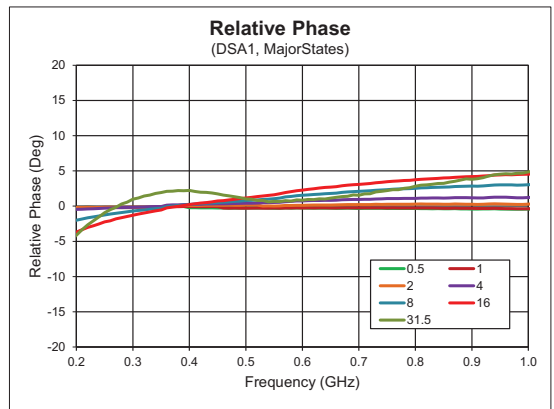
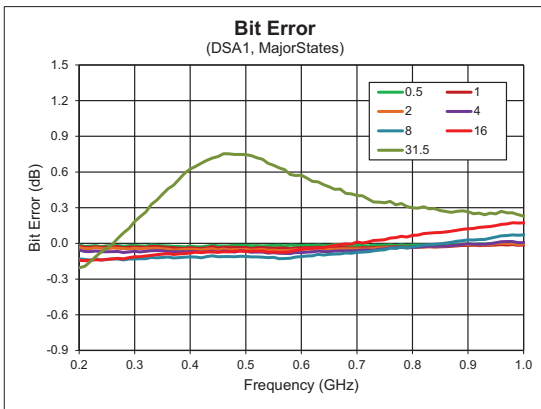
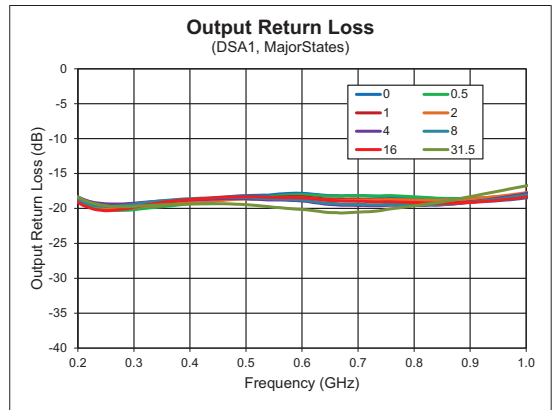
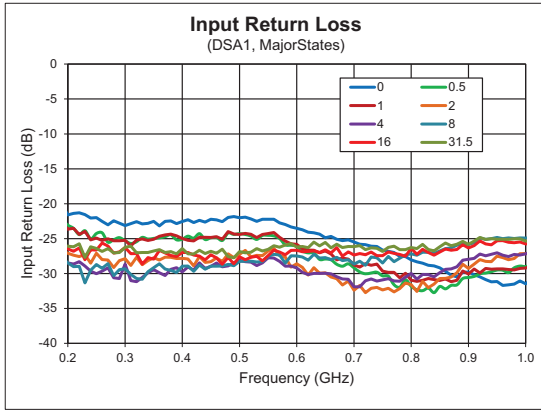

## Test Conditions: Changing DSA2 setting, with DSA1 at 0dB Attenuation (25 ° C)

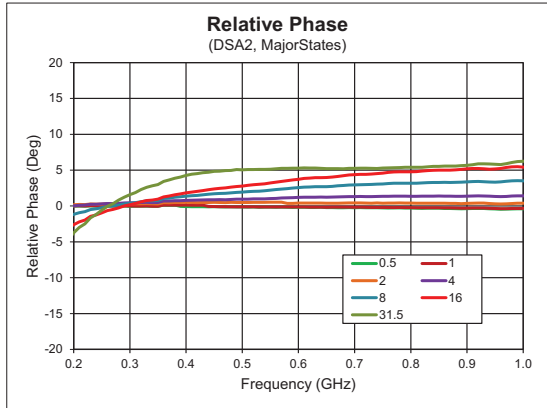
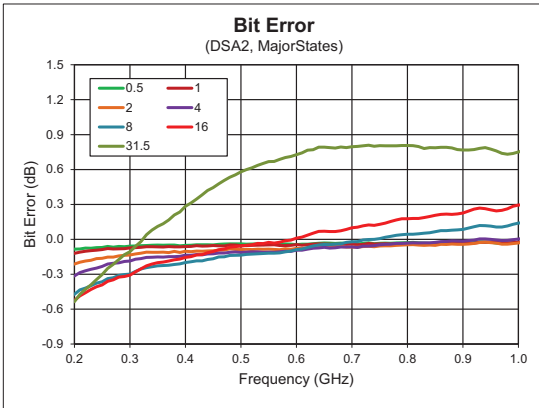
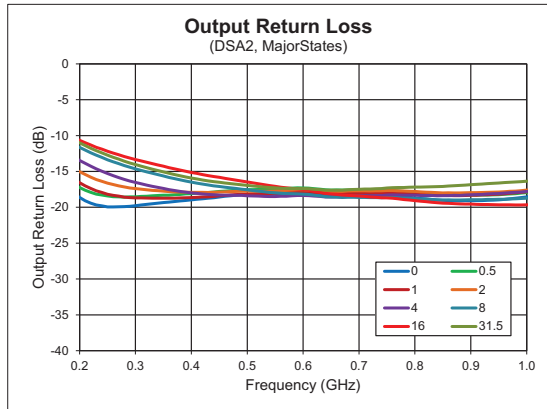
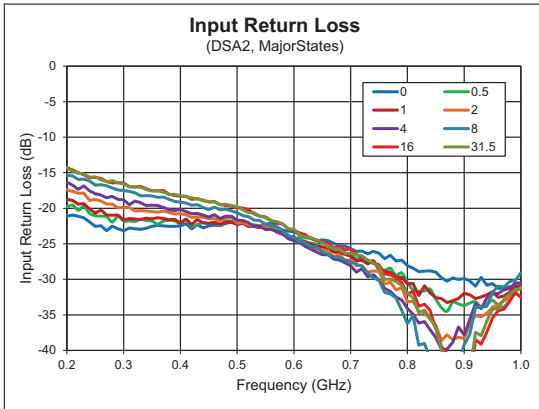



## Truth Table

DSA1 Control Bit						Gain Relative to Maximum Gain
D5	D4	D3	D2	D1	D0	
1	1	1	1	1	1	0dB
1	1	1	1	1	0	-0.5dB
1	1	1	1	0	1	-1dB
1	1	1	0	1	1	-2dB
1	1	0	1	1	1	-4dB
1	0	1	1	1	1	-8dB
0	1	1	1	1	1	-16dB
0	0	0	0	0	0	-31.5dB

DSA2 Control Bit						Gain Relative to Maximum Gain
D11	D10	D9	D8	D7	D6	
1	1	1	1	1	1	0dB
1	1	1	1	1	0	-0.5dB
1	1	1	1	0	1	-1dB
1	1	1	0	1	1	-2dB
1	1	0	1	1	1	-4dB
1	0	1	1	1	1	-8dB
0	1	1	1	1	1	-16dB
0	0	0	0	0	0	-31.5dB

### Programming Example - 12 Bit

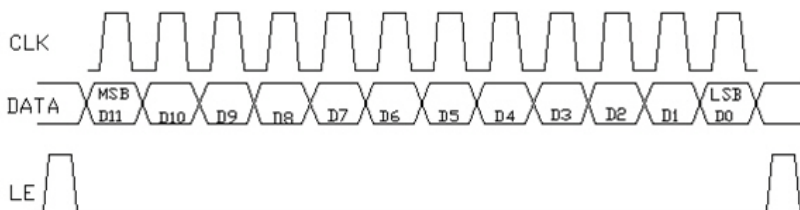

Power-up Programming Truth Table	
PUP	Attenuator Setting
Low	Attenuation at Max, 31.5dB
High	Attenuation at Min, 0dB

Logic Voltage Table	
State	Logic
Low	0V to 0.8V
High	2.0 to 5.0V

## SPI Timing Diagram

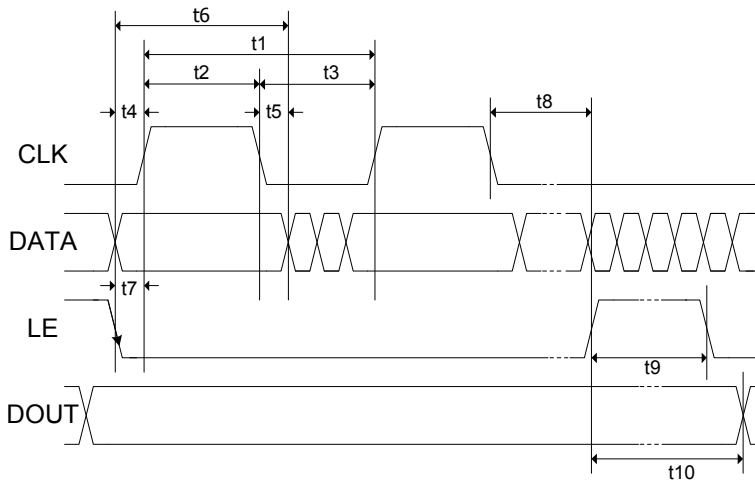

## SPI Timing Diagram Specifications

Parameter	Limit	Unit	Comment
t1	25	MHz max	CLK Frequency
t2	20	ns min	CLK High
t3	20	ns min	CLK Low
t4	5	ns min	DATA to CLK Setup Time
t5	5	ns min	DATA to CLK Hold Time
t6	30	ns min	DATA Valid
t7	5	ns min	LE to CLK Setup Time
t8	5	ns min	CLK to LE Setup Time
t9	10	ns min	LE Pulse Width
t10	20	ns max	Output Set

### Pin Names and Description

Pin	Function	Description
1	<b>AMP1_IN</b>	AMP1 Input
2	<b>DSA1_OUT</b>	DSA1 Output
3	<b>ACG1</b>	AC Ground Connection
4	<b>ACG2</b>	AC Ground Connection
5	<b>ACG3</b>	AC Ground Connection
6	<b>ACG4</b>	AC Ground Connection
7	<b>DSA1_IN</b>	DSA1 Input
8	<b>GND</b>	RF/DC Ground Connection
9	<b>PUP</b>	Power Up Programming pin
10	<b>DATA</b>	Serial Data Input
11	<b>LE</b>	Serial Latch Enable
12	<b>CLK</b>	Serial Clock Input
13	<b>VDD</b>	Supply Voltage for DSA and SPI Control
14	<b>GND</b>	RF/DC Ground Connection
15	<b>AMP2_OUT</b>	AMP2 OUT and Bias pin
16	<b>GND</b>	RF/DC Ground Connection
17	<b>GND</b>	RF/DC Ground Connection
18	<b>AMP2_IN</b>	AMP2 Input
19	<b>DSA2_OUT</b>	DSA2 Output
20	<b>GND</b>	RF/DC Ground Connection
21	<b>ACG5</b>	AC Ground Connection
22	<b>ACG6</b>	AC Ground Connection
23	<b>ACG7</b>	AC Ground Connection
24	<b>ACG8</b>	AC Ground Connection
25	<b>DSA2_IN</b>	DSA2 Input
26	<b>AMP1_OUT</b>	AMP1 Output and Bias pin
27	<b>GND</b>	RF/DC Ground Connection
28	<b>GND</b>	RF/DC Ground Connection

## Evaluation Board Schematic 5MHz to 250MHz Application Circuit

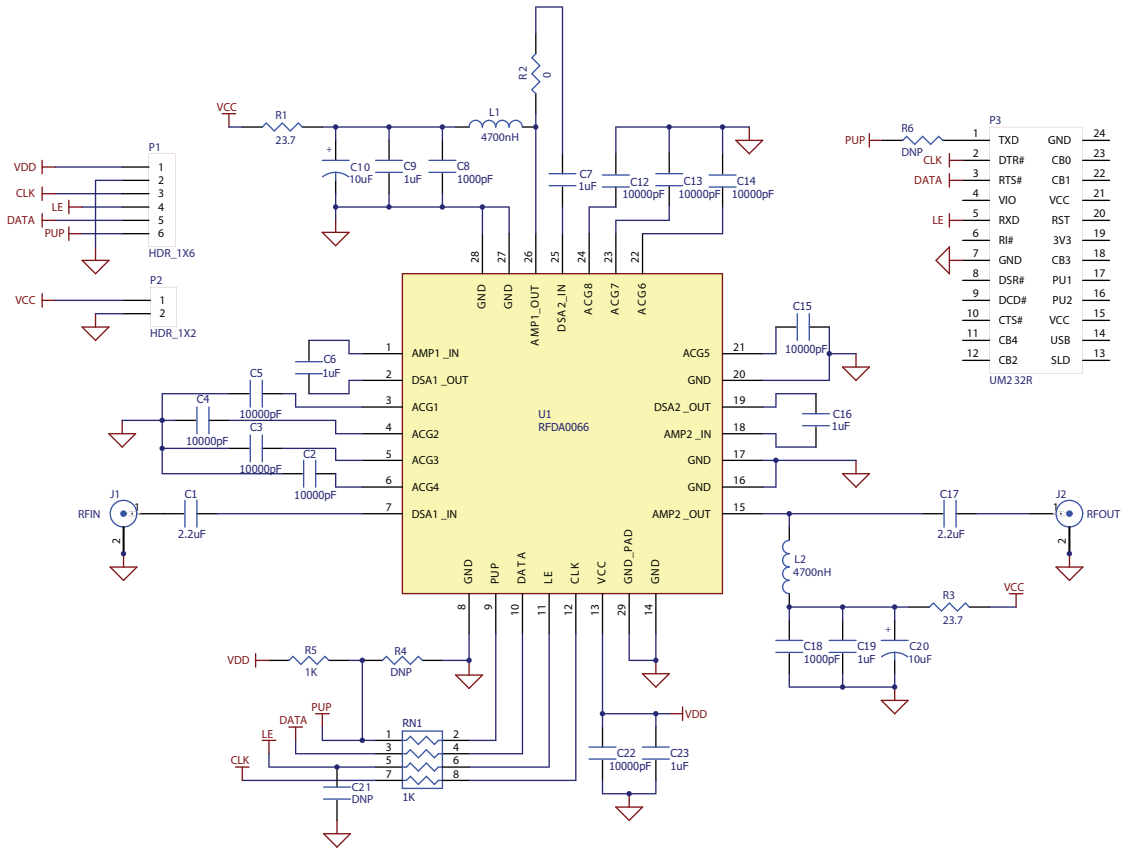

**\*Required Bias Resistance for  $I_{CC} = 115\text{mA}$  (one Amplifier)**

$$\text{Bias Resistance} = R_{\text{BIAS}} + R_{\text{CHOKE}} = (V_{\text{CC}} - V_{\text{D}}) / I_{\text{CC}}$$

( $V_{\text{CC}}$ : Supply Voltage;  $V_{\text{D}}$ : Voltage on the device, ~4.9-5.0V;  $R_{\text{BIAS}}$ : Bias Resistor;  $R_{\text{CHOKE}}$ : DCR of choke)

### Bias Resistance

Supply Voltage	7V	8V	9V	12V
Bias Resistance	19Ω	27.5Ω	36Ω	63Ω

**Evaluation Board Build of Materials (BOM)**

5MHz to 250MHz Application Circuit

Description	Reference Designator	Manufacturer	Manufacturer's P/N
Evaluation Board		RFMD	RFDA0066410(B)
Digital Controlled Variable Gain Amplifier	U1	RFMD	RFDA0066SB
CAP, 2.2 $\mu$ F, 10%, 10V, X5R, 0603	C1, C17	Murata Electronics	GRM188R61A225KE34D
CAP, 10000pF, 10%, 16V, X7R, 0402	C2-C5, C12-C15, C22	Taiyo Yuden (USA), Inc.	RM EMK105BJ103KV-F
CAP, 1 $\mu$ F, 10%, 6.3V, X5R, 0402	C6-C7, C9, C16, C19, C23	Taiyo Yuden (USA), Inc.	RM JMK105BJ105KVLF
CAP, 1000pF, 10%, 50V, X7R, 0402	C8, C18	Taiyo Yuden (USA), Inc.	RM UMK105BJ102KV-F
CAP, 10 $\mu$ F, 10%, 16V, TANT-B	C10, C20	AVX Corporation	TAJB106K016R
IND, 4700nH, 10%, W/W, 1008	L1-L2	Coilcraft, Inc.	1008CS-472XKBC
CONN, HDR, ST, 6-PIN, 0.100"	P1	SAMTEC INC.	TSW-106-07-G-S
CONN, HDR, ST, 2-PIN, 0.100"	P2	SAMTEC INC.	TSW-102-07-G-S
CONN, SKT, 24-PIN DIP, .600", T/H	P3	Aries Electronics, Inc.	24-6518-10
CONN, SMA, END LNCH, RND PIN, 0.059"	J1-J2	GIGALANE CO., LTD.	PSF-S01-006
RES, 23.7 $\Omega$ , 1%, 3/4W, 2010	R1, R3	PANASONIC INDUSTRIAL CO	ERJ12SF23R7U
JMPR, 0 $\Omega$ , 0603	R2	PANASONIC INDUSTRIAL CO	ERJ-3GEYOR00
RES, 1K, 1%, 1/16W, 0603	R5	PANASONIC INDUSTRIAL CO	ERJ-3EKF1001V
RES ARRAY, 4-ELEM, 1K, 5%, SMD 4x0402	RN1	KOA Speer Electronics, Inc.	CN1E4KTTD102J
DNI	C11, C21, R4, R6, J3		

## Evaluation Board Schematic 400MHz to 1GHz Application Circuit

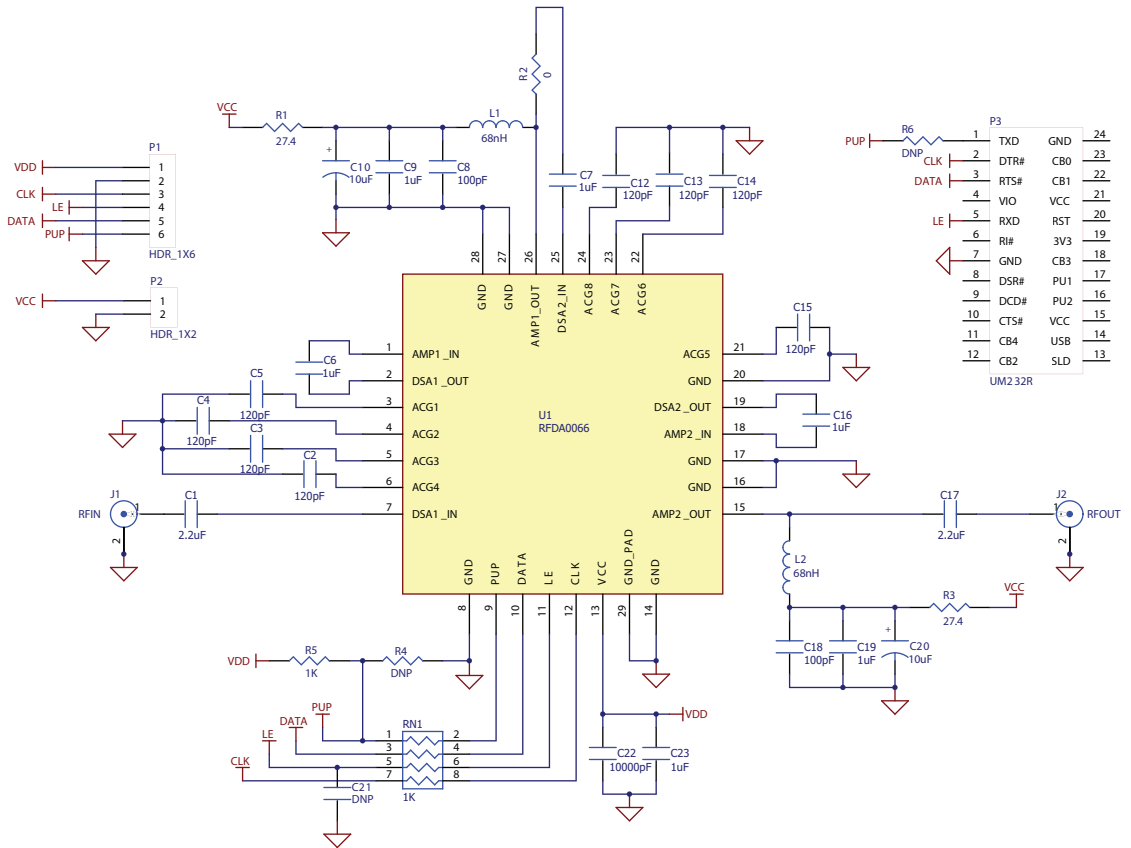

**Evaluation Board Build of Materials (BOM)**

## 400MHz to 1GHz Application Circuit

Description	Reference Designator	Manufacturer	Manufacturer's P/N
Evaluation Board		RFMD	RFDA0066410(B)
Digital Controlled Variable Gain Amplifier	U1	RFMD	RFDA0066SB
CAP, 2.2 $\mu$ F, 10%, 10V, X5R, 0603	C1, C17	Murata Electronics	GRM188R61A225KE34D
CAP, 10000pF, 10%, 16V, X7R, 0402	C22	Taiyo Yuden (USA), Inc	RM EMK105BJ103KV-F
CAP, 120pF, 5%, 50V, CG, 0402	C2-C5, C12-C15	Taiyo Yuden (USA), Inc	RM UMK105CG121JV-F
CAP, 1 $\mu$ F, 10%, 6.3V, X5R, 0402	C6-C7, C9, C16, C19, C23	Taiyo Yuden (USA), Inc	RM JMK105BJ105KVLF
CAP, 100pF, 5%, 50V, COG, 0402	C8, C18	Taiyo Yuden (USA), Inc	RM UMK105CG101JV-F
CAP, 10 $\mu$ F, 10%, 16V, TANT-B	C10, C20	AVX Corporation	TAJB106K016R
IND, 68nH, 5%, W/W, 1008	L1-L2	Coilcraft, Inc.	1008CS-680XJBC
CONN, HDR, ST, 6-PIN, 0.100"	P1	SAMTEC INC.	TSW-106-07-G-S
CONN, HDR, ST, 2-PIN, 0.100"	P2	SAMTEC INC.	TSW-102-07-G-S
CONN, SKT, 24-PIN DIP, .600", T/H	P3	Aries Electronics, Inc.	24-6518-10
CONN, SMA, END LNCH, RND PIN, 0.059"	J1-J2	GIGALANE CO., LTD.	PSF-S01-006
RES, 27.4 $\Omega$ , 1%, 3/4W, 2010	R1, R3	PANASONIC INDUSTRIAL CO	ERJ12SF27R4U
JMPR, 0 $\Omega$ , 0603	R2	PANASONIC INDUSTRIAL CO	ERJ-3GEY0R00
RES, 1K, 1%, 1/16W, 0603	R5	PANASONIC INDUSTRIAL CO	ERJ-3EKF1001V
RES ARRAY, 4-ELEM, 1K, 5%, SMD 4x0402	RN1	KOA Speer Electronics, Inc.	CN1E4KTTD102J
DNI	C11, C21, R4, R6, J3		

## Evaluation Board Assembly Drawing

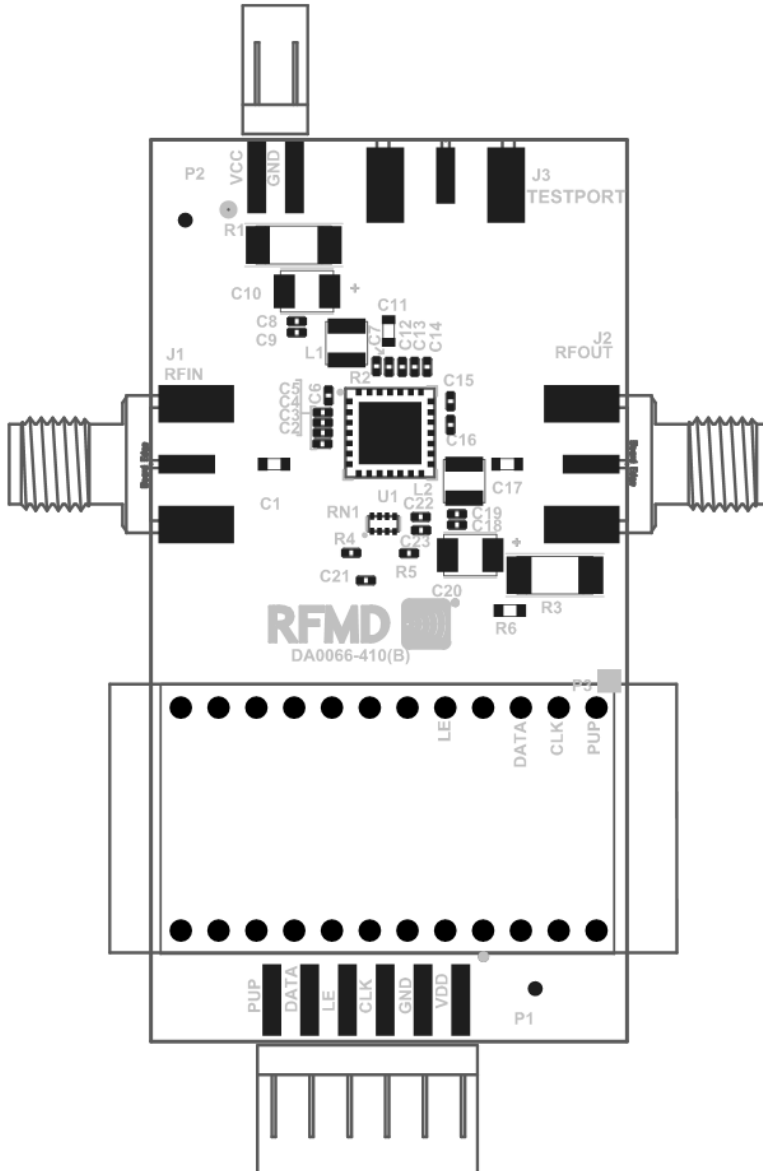



**Package Drawing**  
6.0mmx6.0mm Laminate Module

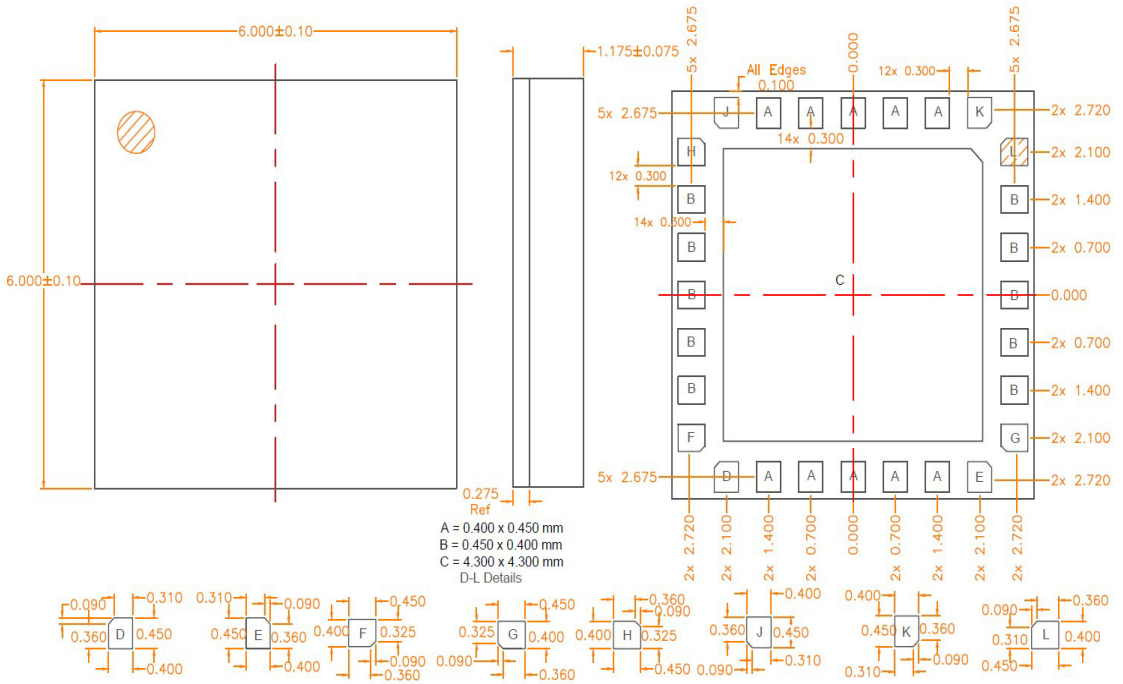

The module thickness tolerance is: +/- .04mm. All other dim tolerances are +/- .075mm unless otherwise noted.

## Branding Diagram

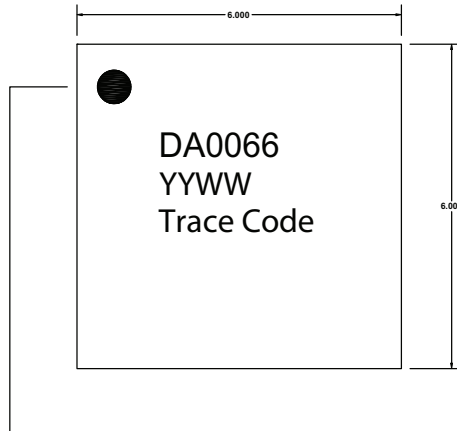

Pin 1 Indicator

Fill in the YYWW Notation with the Date Code

YY = Year

WW = Week

Trace Code to be assigned by SubCon