



Features

- 500MHz to 2500MHz Operation
- 6-Bit Digital Step Attenuator
- Serial Control Interface
- 31.5 dB Attenuation Range (0.5dB Step)
- High OIP3/P1dB= +43/25 dBm
- Gain=-20dB to +11.5dB at 2017 MHz
- Single +5V Supply
- Robust 1000V HBM ESD
- Footprint Compatible with 32-Pin 5mmx5mm QFN

Applications

- Cellular, PCS, 3G Infrastructure
- WiBro, WiMax, LTE
- High Linearity Power Control

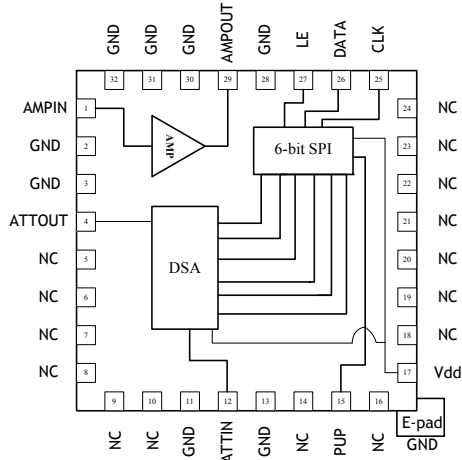

Functional Block Diagram

Product Description

RFMD’s RFDA2025 is a digital controlled variable gain amplifier featuring high linearity over the entire gain control range. The 6-bit digital step attenuator is programmed with a serial mode control interface. The RFDA2025 is packaged in a small 5.2mmx5.2mm leadless laminate MCM with plated through thermal vias for ultra low thermal resistance. The footprint for this module is directly compatible with most 32-pin 5mmx5mm QFNs. The output amplifier is externally matched, allowing for optimum performance over specific bands within 500MHz to 2500MHz.

Ordering Information

RFDA2025SQ	Sample bag with 25 pieces
RFDA2025SR	7" Reel with 100 pieces
RFDA2025TR7	7" Reel with 750 pieces
RFDA2025TR13	13" Reel with 2500 pieces
RFDA2025PCK-410	1800 MHz to 2200 MHz PCBA with 5-piece sample bag

Optimum Technology Matching® Applied

- | | | | |
|--|--------------------------------------|--|-----------------------------------|
| <input checked="" type="checkbox"/> GaAs HBT | <input type="checkbox"/> SiGe BiCMOS | <input checked="" type="checkbox"/> GaAs pHEMT | <input type="checkbox"/> GaN HEMT |
| <input type="checkbox"/> GaAs MESFET | <input type="checkbox"/> Si BiCMOS | <input checked="" type="checkbox"/> Si CMOS | <input type="checkbox"/> RF MEMS |
| <input type="checkbox"/> InGaP HBT | <input type="checkbox"/> SiGe HBT | <input type="checkbox"/> Si BJT | <input type="checkbox"/> LDMOS |

RF MICRO DEVICES®, RFMD®, Optimum Technology Matching®, Enabling Wireless Connectivity™, PowerStar®, POLARIS™ TOTAL RADIO™ and UltimateBlue™ are trademarks of RFMD, LLC. BLUETOOTH is a trademark owned by Bluetooth SIG, Inc., U.S.A. and licensed for use by RFMD. All other trade names, trademarks and registered trademarks are the property of their respective owners. ©2006, RF Micro Devices, Inc.

Absolute Maximum Ratings

Parameter	Rating	Unit
Supply Voltage (V_{CC} , V_{DD})	5.5	V
Collector Current (I_C)	200	mA
Power Dissipation ¹ (P_{DISS})	750	mW
RF Input Power	20	dBm
Operating Temperature (T_{CASE})	-40 to +85	°C
Junction Temperature (T_J)	150	°C
Storage Temperature	-40 to +150	°C
ESD Rating (HBM)	Class 1C	
Moisture Sensitivity Level	MSL 3	



Caution! ESD sensitive device.

Exceeding any one or a combination of the Absolute Maximum Rating conditions may cause permanent damage to the device. Extended application of Absolute Maximum Rating conditions to the device may reduce device reliability. Specified typical performance or functional operation of the device under Absolute Maximum Rating conditions is not implied.

RoHS status based on EUDirective2002/95/EC (at time of this document revision).

The information in this publication is believed to be accurate and reliable. However, no responsibility is assumed by RF Micro Devices, Inc. ("RFMD") for its use, nor for any infringement of patents, or other rights of third parties, resulting from its use. No license is granted by implication or otherwise under any patent or patent rights of RFMD. RFMD reserves the right to change component circuitry, recommended application circuitry and specifications at any time without prior notice.

Notes:

$$1. P_{DISS} = V_{CC} * I_C - \text{RF Output Power} + \text{RF Input Power}$$

Parameter	Specification			Unit	Condition
	Min.	Typ.	Max.		
Frequency Range	500		2500	MHz	
Gain (Max Gain State)	10.0	11.5	13.0	dB	Attenuation = 0dB, 2017 MHz
Gain Control Range		31.5		dB	0.5 dB LSB, 6 bits
Step Accuracy	±(0.1 +5% attenuation setting)			dB	Major state max error
Output IP3	40	43		dBm	2017 MHz, $P_{OUT} = 5$ dBm/ tone, 1 MHz spacing
Output P1dB	23	25		dBm	Attenuation = 0dB, 2017 MHz
Input Return Loss		17		dB	2017 MHz
Output Return Loss		11		dB	2017 MHz
Noise Figure		7		dB	2017 MHz, Attenuation = 0dB
t_{RISE} , t_{FALL}		250		ns	10/90% RF
Amplifier Supply Voltage (V_{CC})	4.75	5.00	5.25	V	
Attenuator Supply Voltage (V_{DD})	3.30	5.00	5.25	V	
Total Supply Current	90	115	135	mA	Sum of currents from V_{DD} and V_{CC}
Thermal Resistance		87		°C/W	
Control Interface	6 Bit, Serial				
Control Voltages	Low, $V_{CTL} = 0$ to $0.8 V_{DC}$ High, $V_{CTL} = 2.0$ to $V_{DD} V_{DC}$			V	
Notes:					
1. All measurements based on the 1800MHz to 2200MHz Application Circuit, $T = 25$ °C					
2. $V_{CC} = V_{DD} = +5V$, $V_{CTL} = 0/5V$					

Typical Performance - 1.8GHz to 2.2GHz Application Circuit Performance

Gain, Major States, 25 °C

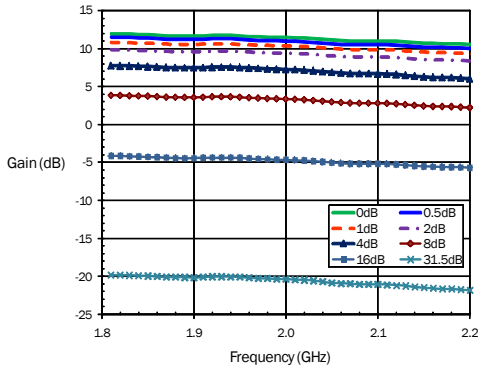

S21 over Temperature, Max Gain

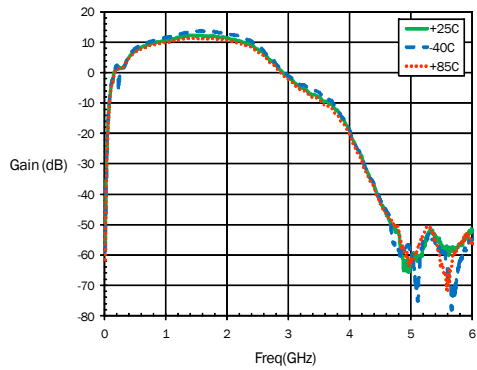

Input RL, Major States, 25 °C

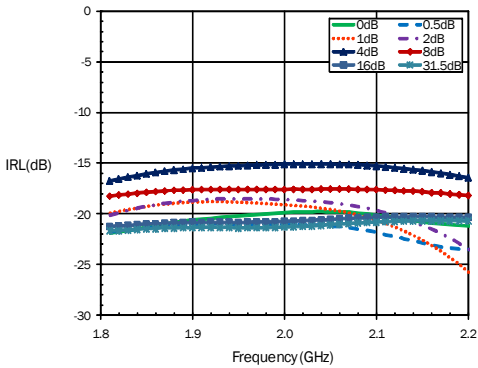

Input Return Loss over Temperature, Max Gain

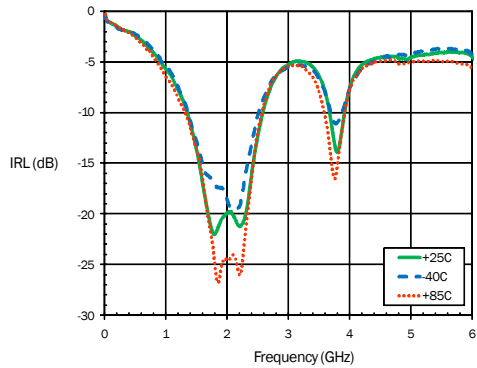

Output RL, Major States, 25 °C

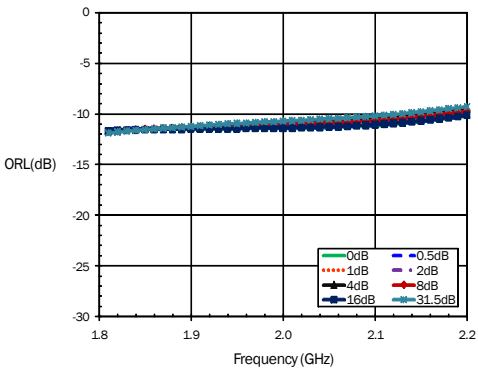

Output Return Loss over Temperature, Max Gain

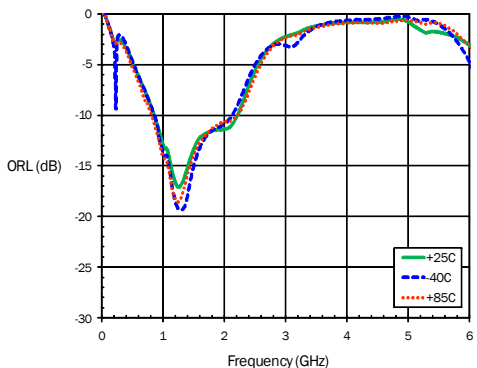

Typical Performance - 1.8GHz to 2.2GHz Application Circuit Performance

Isolation, Major States, 25 °C

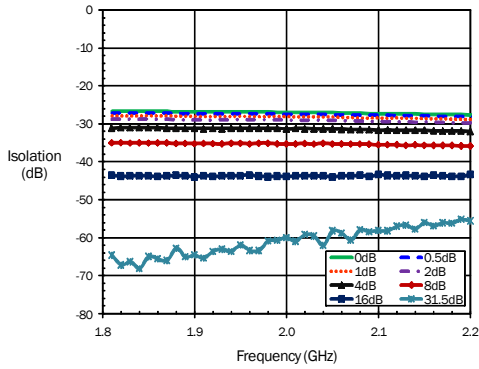

Isolation over Temperature, Max Gain

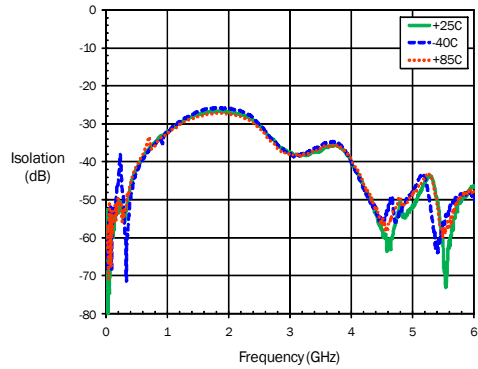

Attenuation Error, Major States, 25 °C

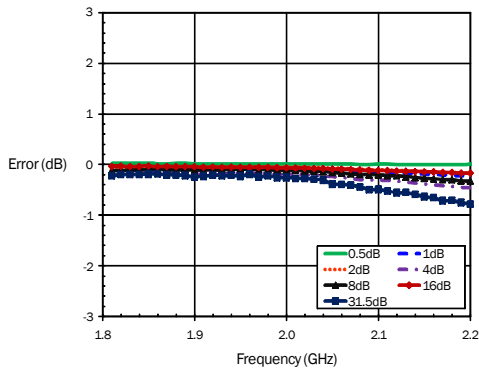

Attenuation Error, Major States, 85 °C

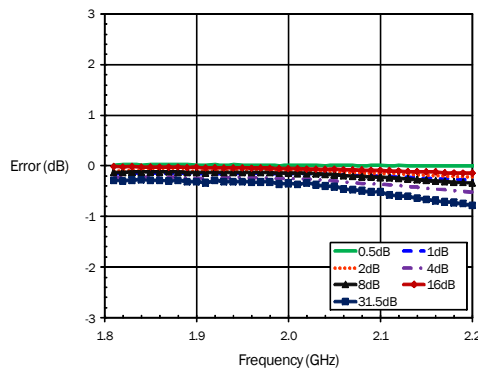

Attenuation Error, Major States, -40 °C

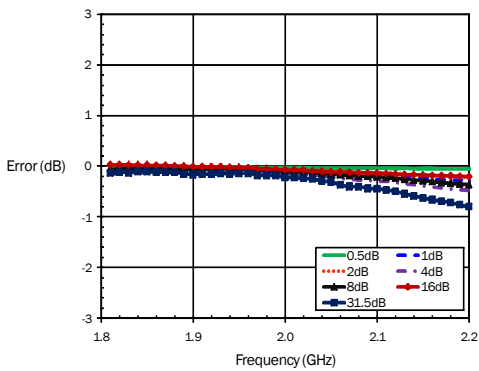

Normalized Phase Error, Major States, 25 °C

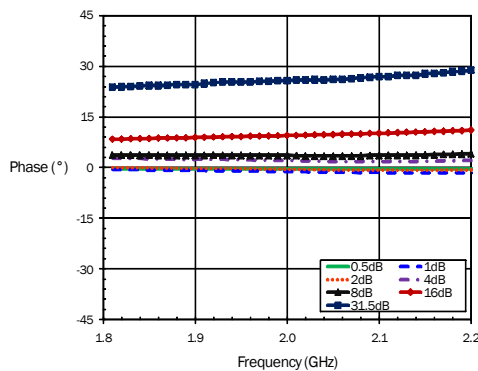

Typical Performance: 1.8GHz to 2.2GHz Application Circuit Performance

Successive Step Error at 2020MHz

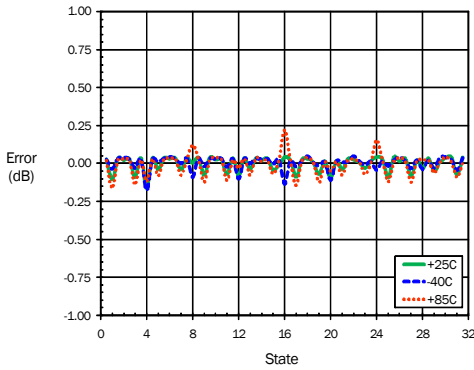

Worst Case Successive Step Error, 25 °C

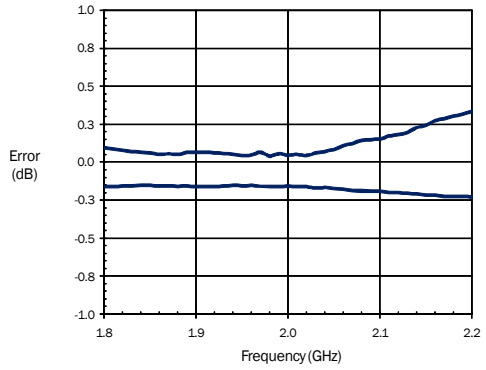

OIP3 over Temperature, Max Gain

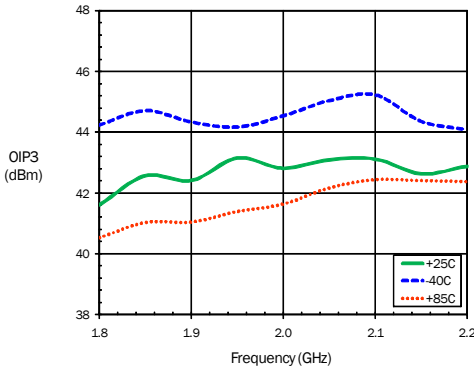

OIP3, Major States, 25 °C

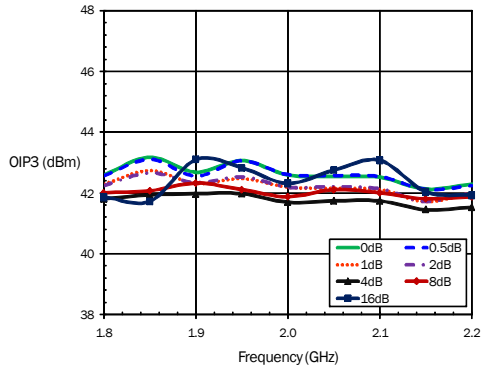

P1dB over Temperature, Max Gain

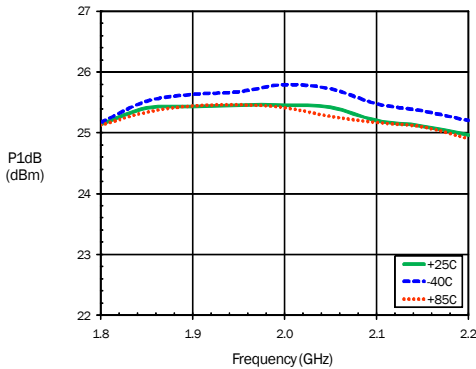

**ACPR over Temperature, Max Gain
WCDMA, 64 DPCH, 2017MHz**

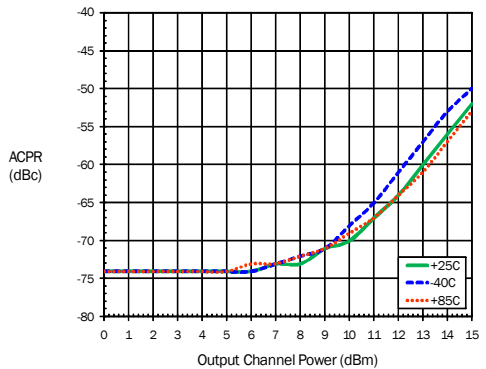

Typical Performance - 1.8GHz to 2.2GHz Application Circuit Performance

Noise Figure over Temperature, Max Gain

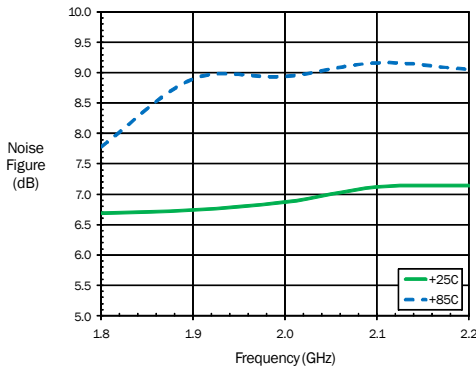

DCIV over Temperature, Max Gain

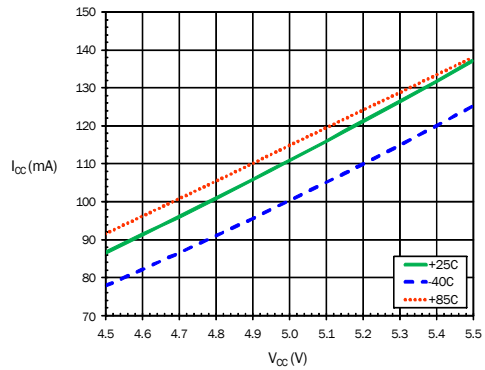

Truth Table

DSA Control Bits						Relative Gain Setting
D5 16dB	D4 8dB	D3 4dB	D2 2dB	D1 1dB	D0 0.5dB	
1	1	1	1	1	1	Max Gain
1	1	1	1	1	0	-0.5dB
1	1	1	1	0	1	-1dB
1	1	1	0	1	1	-2dB
1	1	0	1	1	1	-4dB
1	0	1	1	1	1	-8dB
0	1	1	1	1	1	-16dB
0	0	0	0	0	0	-31.5dB

Serial Port Interface: SPI Timing Diagram

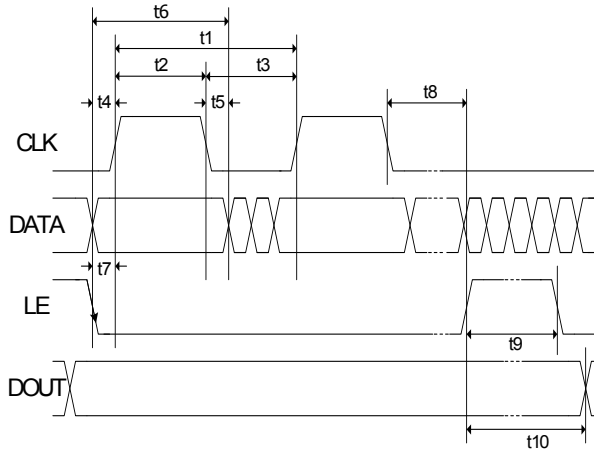

Programming example – 6 bit

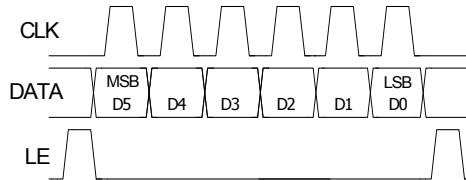

Specifications: SPI Timing Diagram

Parameter	Limit	Unit	Comment
t1	25	MHz max	CLK Frequency
t2	20	ns min	CLK High
t3	20	ns min	CLK Low
t4	5	ns min	DATA to CLK Setup Time
t5	5	ns min	DATA to CLK Hold Time
t6	30	ns min	DATA Valid
t7	5	ns min	LE to CLK Setup Time
t8	5	ns min	CLK to LE Setup Time
t9	10	ns min	LE Pulse Width
t10	20	ns max	Output Set

Control Voltage Table		
State	V _{DD} =+3V	V _{DD} =+5V
Low	0V to 0.8V	0V to 0.8V
High	2.0 to V _{DD}	2.0 to V _{DD}

Power Up Programming Truth Table	
PUP	Attenuator Setting
Low	Attenuation at Max, 31.5dB
High	Attenuation at Min, 0dB

Pin	Function	Description
1	AMPIN	Amplifier Input - DC Block Required.
2	GND	RF/DC Ground Connection.
3	GND	RF/DC Ground Connection.
4	ATTOUT	Digital Attenuator Output - DC Block Required.
5	NC	No internal connection.
6	NC	No internal connection.
7	NC	No internal connection.
8	NC	No internal connection.
9	NC	No internal connection.
10	NC	No internal connection.
11	GND	RF/DC Ground Connection.
12	ATTIN	Digital Attenuator Input - DC Block Required.
13	GND	RF/DC Ground Connection.
14	NC	No internal connection.
15	PUP	Power-up programming pin. Low=Max attenuation at power-up (-31.5dB). High=Min attenuation at power-up (0dB).
16	NC	No internal connection.
17	VDD	Digital Attenuator Supply Voltage.
18	NC	No internal connection.
19	NC	No internal connection.
20	NC	No internal connection.
21	NC	No internal connection.
22	NC	No internal connection.
23	NC	No internal connection.
24	NC	No internal connection.
25	CLK	Serial Clock.
26	DATA	Serial Data.
27	LE	Latch Enable.
28	GND	RF/DC Ground Connection.
29	AMPOUT/VCC	Amplifier Output and Bias. External Choke, Bypassing and DC Blocks Required.
30	GND	RF/DC Ground Connection.
31	GND	RF/DC Ground Connection.
32	GND	RF/DC Ground Connection.

Evaluation Schematic - 1800MHz to 2200MHz Application Circuit

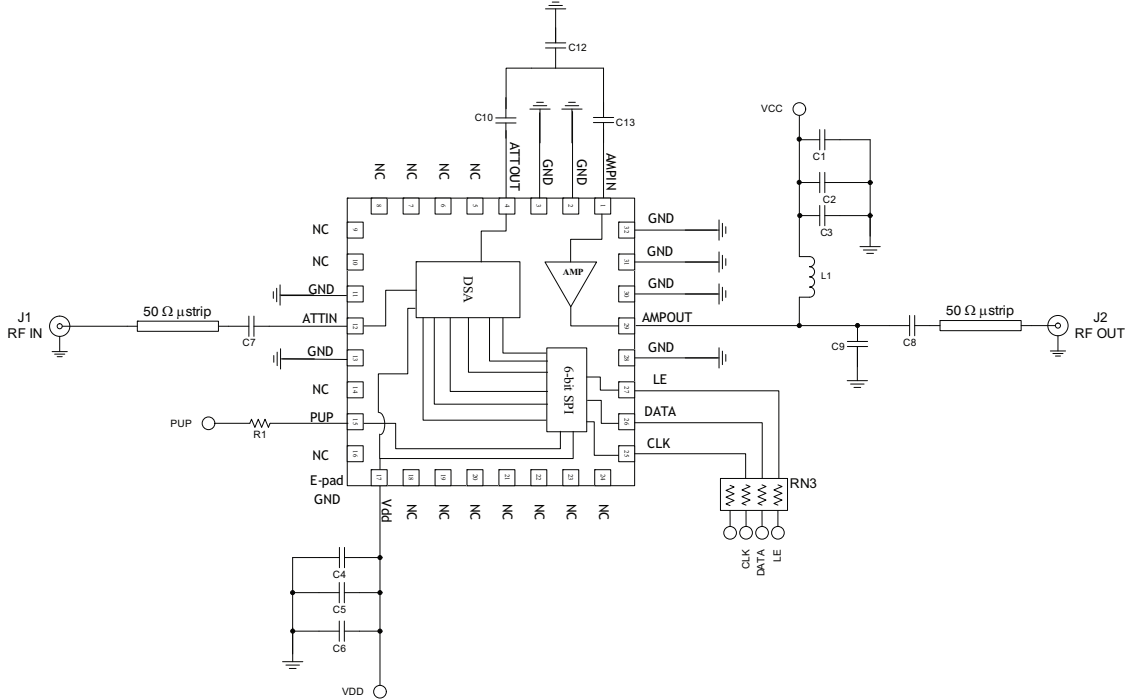

Bill of Materials - 1800MHz to 2200MHz Application Circuit

Description	Reference Designator	Manufacturer	Manufacturer's P/N
RFDA2025SB	U1	RFMD	RFDA2025
RFDA2015, PCB			RFDA2015410 (A)
CONN, SMA, END LNCH, FLT, 0.062"	J1, J2	Emerson Network Power	142-0701-821
CAP, 1000pF, 10%, 50V, X7R, 0603	C2, C5	Murata Electronics	GRM188R71H102KA01D
CAP, 22pF, 5%, 50V, C0G, 0402	C3, C7, C8	PANASONIC INDUSTRIAL CO	ECJ-0EC1H220J
CAP, 1uF, 10%, 16V, X7R, 0805	C1, C6	Murata Electronics	GRM21BR71C105KA01K
CAP, 100pF, 5%, 50V, C0G, 0402	C4	PANASONIC INDUSTRIAL CO	ECJ-0EC1H101J
CAP, 1.2pF, +/-0.1pF, 50V, C0G, 0402	C9	Murata Electronics	GRM1555C1H1R2BZ01E
IND, 18nH, 5%, M/L, 0603	L1	Toko America, Inc.	LL1608-FSL18NJ
RES, 0 OHM, 0402	C10	Kamaya, Inc	RMCI1/16SJPTH
RES, 1K, 5%, 1/16W, 0402	R1	Kamaya, Inc	RMCI1/16S-102JTH
RES ARRAY, 4-ELEM, 1K, 5%, SMD 4 X 0402	RN3	KOA	CN1E4KTTD102J
CAP, 3.3pF, +/-0.1pF, 50V, COG, 0402	C13	Murata Electronics	GRM1555C1H3R3BZ01E
CONN, HDR, ST, PLRZD, 2-PIN, 0.100"	P2	ITW Pancon	MPSS100-2-C
CONN, HDR, ST, PLRZD, 14-PIN, 0.100"	P1	ITW Pancon	MPSS100-14-C
DNP	C11, C12, RN1, RN2		

Evaluation PCB - 1800MHz to 2200MHz Application Circuit

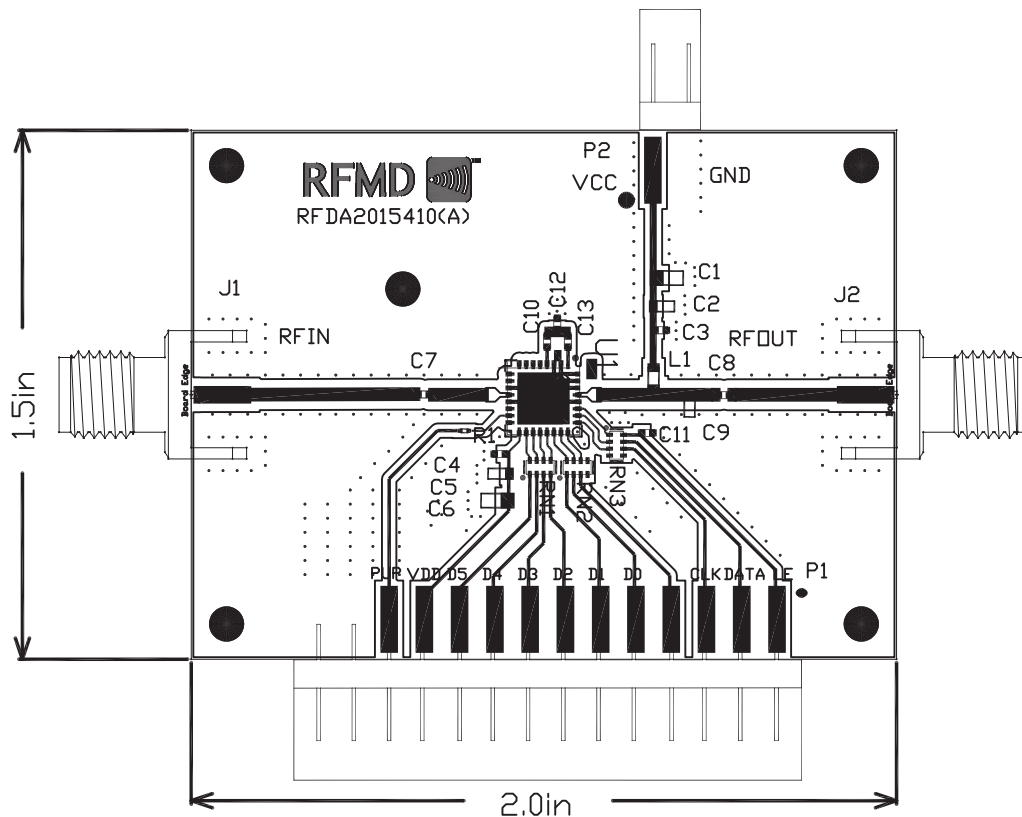

Package Drawing

5.2mmx5.2mm Laminate Module

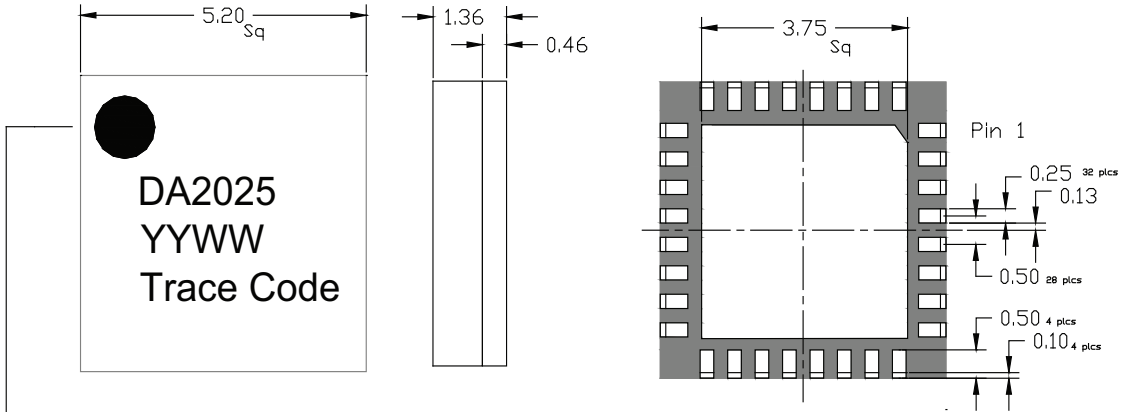

Pin 1 Indicator

Dimensions in millimeters

YY = Year
WW = Week

Trace Code to be assigned by SubCon