



Features

- Frequency Range 1400MHz to 2700MHz
- 6-Bit Digital Step Attenuator
- SPI Serial Control Programming
- Max Gain = 32dB at 2GHz, and 29.3dB @ 2.6GHz
- Gain Control Range = 31.5dB (0.5dB Step Size)
- High OIP3/P1dB = +42.5/25dBm
- Single +5V Supply
- Small 28-Pin, 6.0mm x 6.0mm, MCM
- Power-up Programming

Applications

- Cellular, 3G Infrastructure
- WiBro, WiMax, LTE
- Microwave Radio
- High-Linearity Power Control

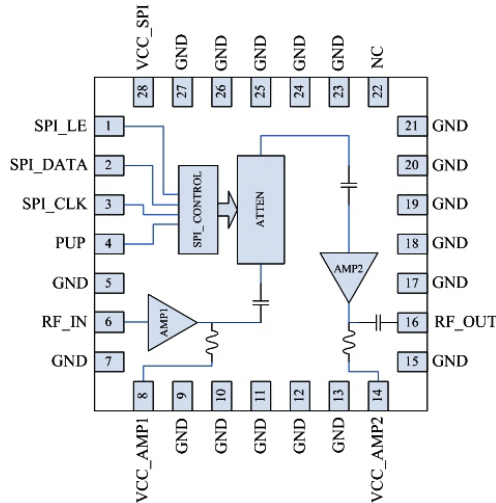

Functional Block Diagram

Product Description

RFMD's RFDA2026 is a digital controlled variable gain amplifier featuring high linearity over the entire gain control range with a noise figure less than 4.1dB in its maximum gain state. The gain of the 6-bit digital step attenuator is programmed with a serial mode control interface (SPI). The RFDA2026 is packaged in a small 6.0mm x 6.0mm leadless laminate MCM, which contains plated through thermal vias for ultra-low thermal resistance. This module is easy to use with no external matching components required.

Ordering Information

RFDA2026SQ	Sample bag with 25 pieces
RFDA2026SR	7" Sample reel with 100 pieces
RFDA2026TR13	13" Reel with 2500 pieces
RFDA2026PCK-410	1.4GHz to 2.4GHz PCBA with 5-piece sample bag
RFDA2026PCK-411	2.4GHz to 2.7GHz PCBA with 5-piece sample bag

Optimum Technology Matching® Applied

- | | | | |
|---|--------------------------------------|--|------------------------------------|
| <input checked="" type="checkbox"/> GaAs HBT | <input type="checkbox"/> SiGe BiCMOS | <input checked="" type="checkbox"/> GaAs pHEMT | <input type="checkbox"/> GaN HEMT |
| <input type="checkbox"/> GaAs MESFET | <input type="checkbox"/> Si BiCMOS | <input checked="" type="checkbox"/> Si CMOS | <input type="checkbox"/> BIFET HBT |
| <input checked="" type="checkbox"/> InGaP HBT | <input type="checkbox"/> SiGe HBT | <input type="checkbox"/> Si BJT | <input type="checkbox"/> LDMOS |

Absolute Maximum Ratings

Parameter	Rating	Unit
Supply Voltage	5.5	V _{DC}
DC Supply Current	300	mA
Power Dissipation (P _{DISS})	1500	mW
Maximum RF Input Power	12	dBm
Operating Temperature (T _{CASE})	-40 to +85	°C
Storage Temperature	-40 to +150	°C
Junction Temperature (T _J)	175	°C
ESD Rating - Human Body Model (HBM)	500 (Class 1B)	V
Moisture Sensitivity Level	MSL 3	

MTTF > 1E6 hours at 175 °C junction temperature.



Caution! ESD sensitive device.

Exceeding any one or a combination of the Absolute Maximum Rating conditions may cause permanent damage to the device. Extended application of Absolute Maximum Rating conditions to the device may reduce device reliability. Specified typical performance or functional operation of the device under Absolute Maximum Rating conditions is not implied.

The information in this publication is believed to be accurate and reliable. However, no responsibility is assumed by RF Micro Devices, Inc. ("RFMD") for its use, nor for any infringement of patents, or other rights of third parties, resulting from its use. No license is granted by implication or otherwise under any patent or patent rights of RFMD. RFMD reserves the right to change component circuitry, recommended application circuitry and specifications at any time without prior notice.



RoHS (Restriction of Hazardous Substances): Compliant per EU Directive 2002/95/EC.

Parameter	Specification			Unit	Condition
	Min.	Typ.	Max.		
Overall					Temp=25 °C, V _{CC} =V _{DD} =5V, Standard Application Circuit
Frequency Range	1400		2700	MHz	
Max Gain		32		dB	Attenuation = 0dB at 2.0GHz
		29.3		dB	Attenuation = 0dB at 2.6GHz
Gain Control Range		31.5		dB	
Step Accuracy	±(0.15 +5% attenuation setting)			dB	Major state error up to 2700MHz
P1dB		25		dBm	Attenuation = 0dB
Output IP3	41.5	44.5		dBm	P _{OUT} =+5dBm/tone, 1 MHz spacing
Control Interface		6		bit	SPI interface
Settling Time		250		ns	t _{ON} , t _{OFF} (10%/90% RF)
Noise Figure		4.1		dB	Attenuation = 0dB
Impedance		50		Ω	
Harmonics (1.5GHz to 2.4GHz)					Using RFDA2026-410 EVB
2nd Harmonic		34		dBc	P _{OUT} = 20dBm; 1.5GHz
		39		dBc	P _{OUT} = 20dBm; 2GHz
		44		dBc	P _{OUT} = 20dBm; 2.4GHz
3rd Harmonics		62		dBc	P _{OUT} = 20dBm; 1.5GHz
		72		dBc	P _{OUT} = 20dBm; 2GHz
		73		dBc	P _{OUT} = 20dBm; 2.4GHz
Harmonics (2.4GHz to 2.7GHz)					Using RFDA2026-411 EVB
2nd Harmonics		43		dBc	P _{OUT} = 20dBm; 2.4GHz
		48		dBc	P _{OUT} = 20dBm; 2.7GHz
3rd Harmonics		70		dBc	P _{OUT} = 20dBm; 2.4GHz
		62		dBc	P _{OUT} = 20dBm; 2.7GHz
Input Return Loss		-15		dB	
Output Return Loss		-11		dB	
Total Supply Current	4.75	5.0	5.25	V	
Supply Current		192		mA	From V _{CC-SPI} , V _{CC-AMP1} and V _{CC-AMP2}
Thermal Resistance		46.2		°C/W	Junction to backside of device

Parameter	Unit	1500MHz	1800MHz	2000MHz	2200MHz	2400MHz	2600MHz
Max Small Signal Gain	dB	32.9	32.5	32.3	31.7	30.8	29.3
Output P1dB	dBm	25.5	25.8	26.2	26.2	25.8	25.6
Output IP3 ¹	dBm	43.5	43.0	42.5	42.0	42.0	43.0
Input Return Loss	dB	-16	-15	-15	-19	-23	-19
Output Return Loss	dB	-10.5	-10.8	-11.8	-14	-14.5	-19
Noise Figure	dB	4.0	4.0	4.1	4.0	4.1	4.2

Note

1. OIP3 is tested at P_{OUT}=+5 dBm/Tone and 1 MHz spacing

1400MHz to 2400MHz Application Circuit Data

Gain versus Frequency and Attenuation State

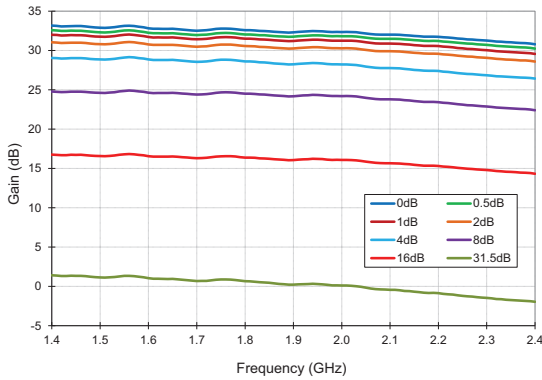

Gain versus Frequency and Temperature at 0dB Attenuation State

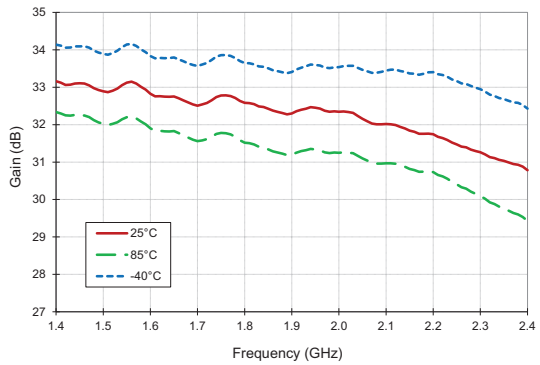

Normalized Attenuation versus Attenuation State

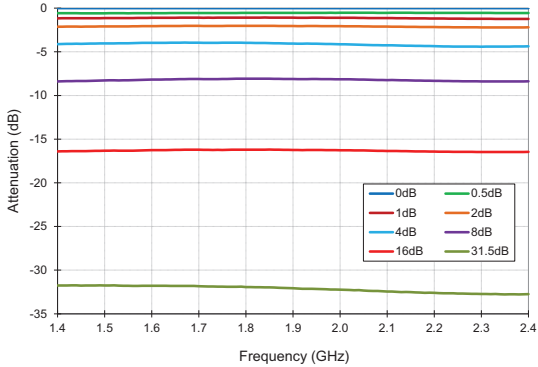

Bit Error versus Frequency and Attenuation State

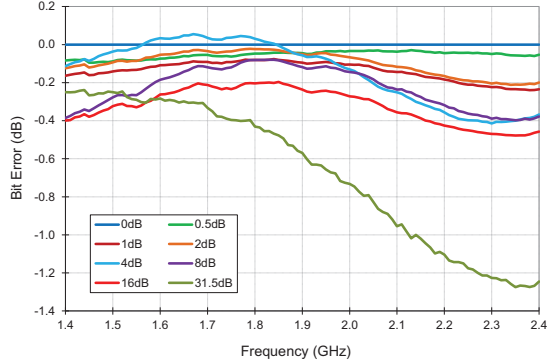

Input Return Loss versus Frequency and Attenuation State

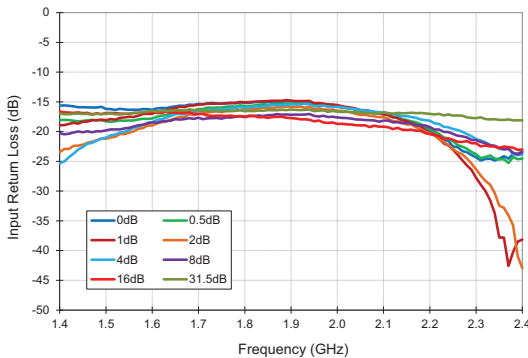

Output Return Loss versus Frequency and Attenuation State

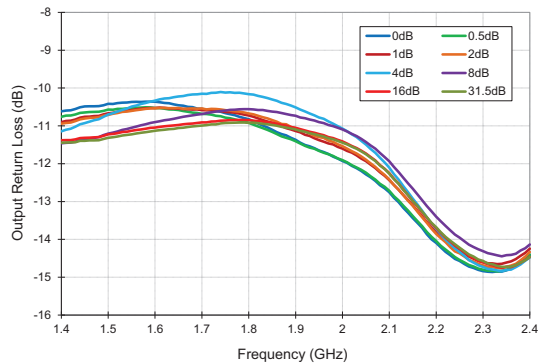

1400MHz to 2400MHz Application Circuit Data

Output IP3 versus Frequency and Temperature

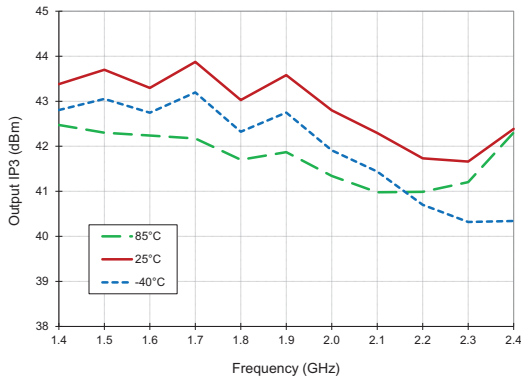

Output P1dB versus Frequency and Temperature

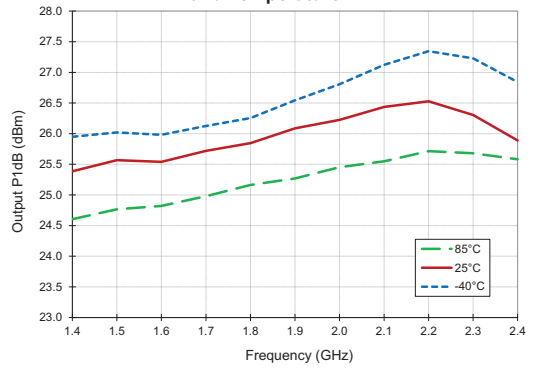

Output IP3 versus Tone Power at 0dB Attenuation State

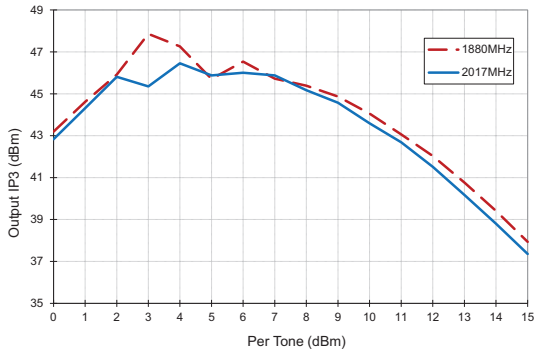

Noise Figure versus Frequency at 0dB Attenuation State

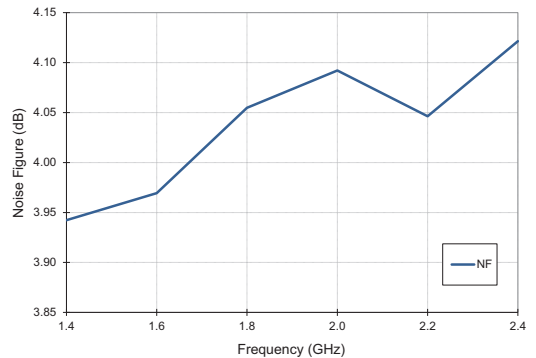

1400MHz to 2400MHz Application Circuit Data

Isolation Over Temperature

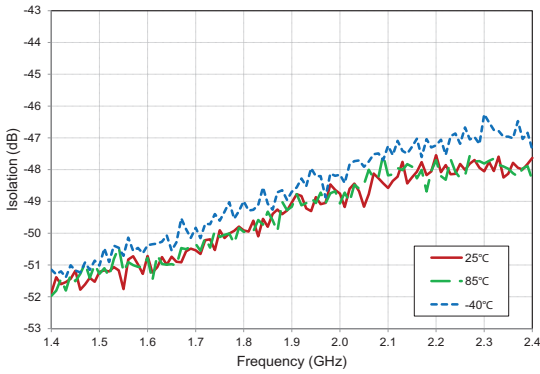

Input Return Loss Over Temperature

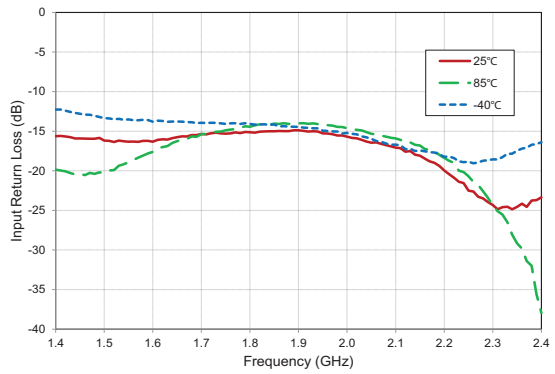

Output Return Loss Over Temperature

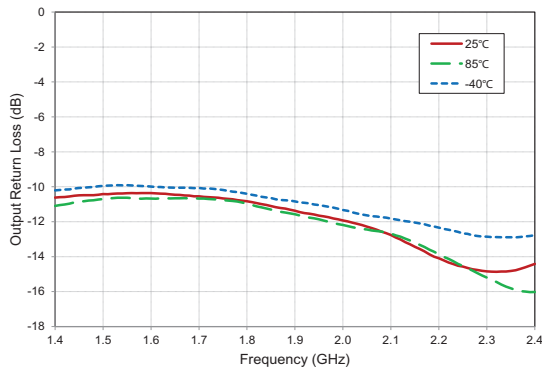

2400MHz to 2700MHz Application Circuit Data

Gain versus Frequency and Attenuation State

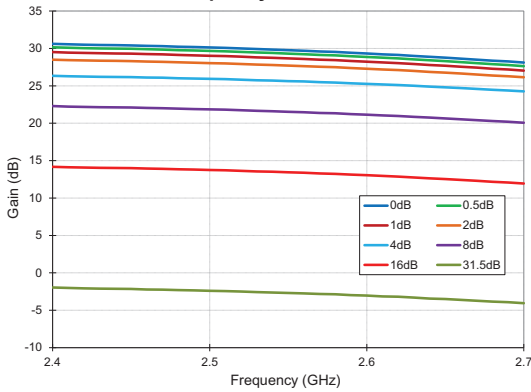

Gain versus Frequency and Temperature at 0dB Attenuation State

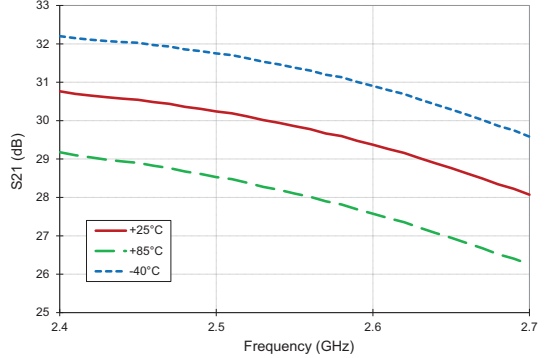

Normalized Attenuation versus Attenuation State

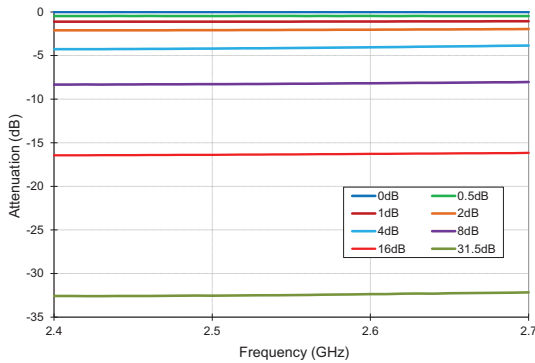

Bit Error versus Frequency and Attenuation State

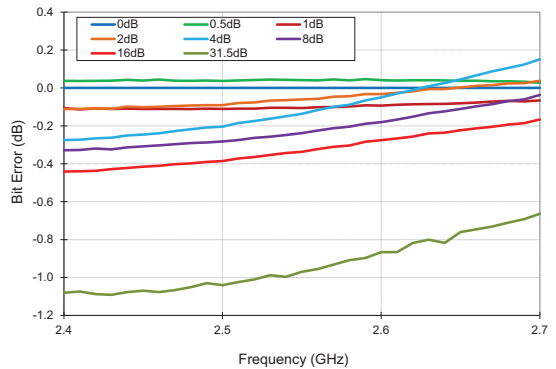

Input Return Loss versus Frequency and Attenuation State

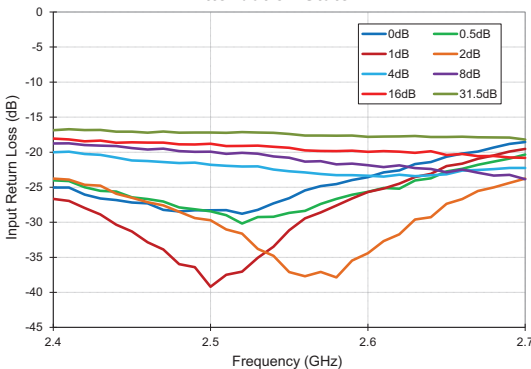

Output Return Loss versus Frequency and Attenuation State

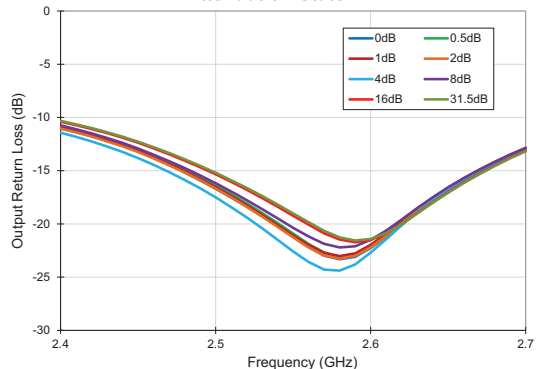

2400MHz to 2700MHz Application Circuit Data

Output IP3 versus Frequency and Temperature

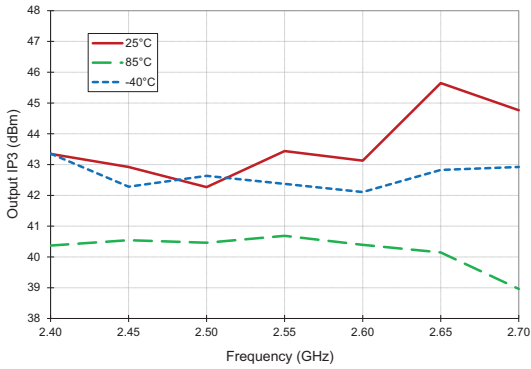

Output P1dB versus Frequency and Temperature

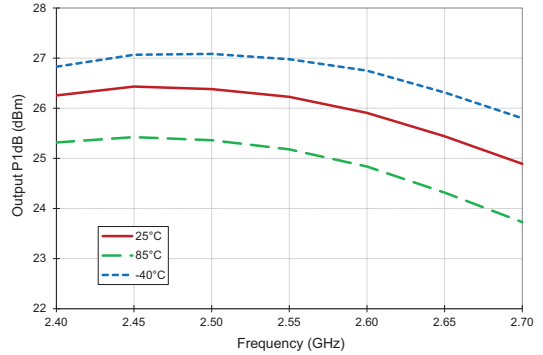

Input Return Loss Over Temperature

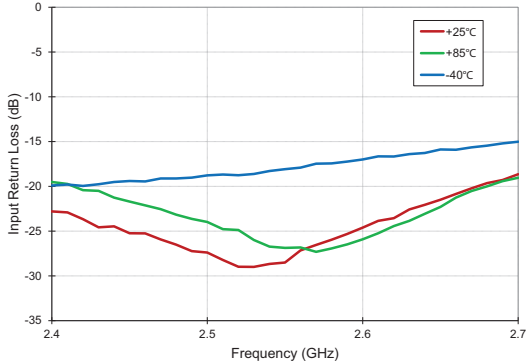

Isolation Over Temperature

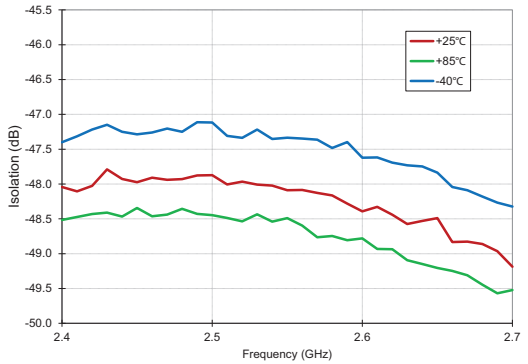

Output Return Loss Over Temperature

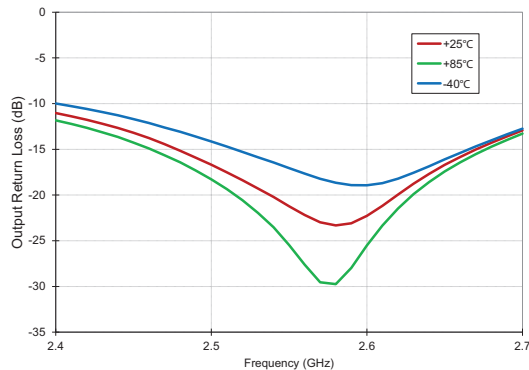

Noise Figure versus Frequency at 0dB Attenuation State

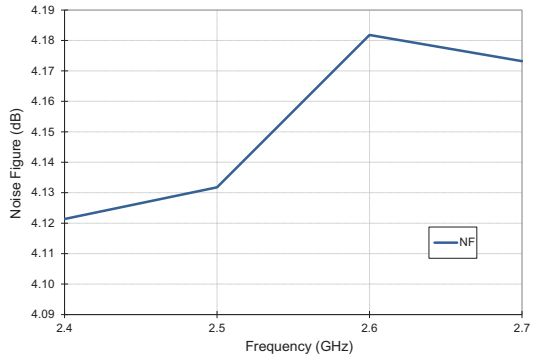

Truth Table

Control Bit						Gain Relative to Maximum Gain
D5	D4	D3	D2	D1	D0	
1	1	1	1	1	1	0dB
1	1	1	1	1	0	-0.5dB
1	1	1	1	0	1	-1dB
1	1	1	0	1	1	-2dB
1	1	0	1	1	1	-4dB
1	0	1	1	1	1	-8dB
0	1	1	1	1	1	-16dB
0	0	0	0	0	0	-31.5dB

Serial Port Interface SPI Timing Diagram

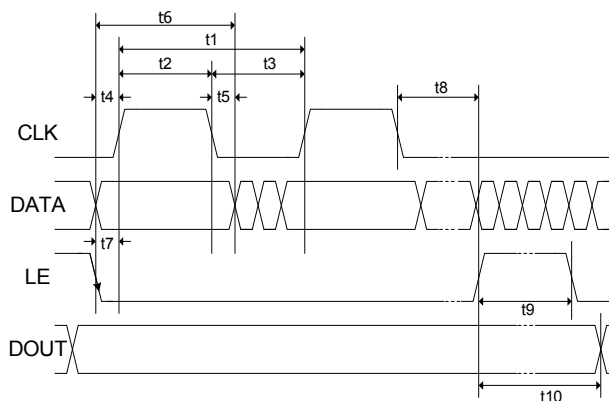

Programming Example, 6-Bit

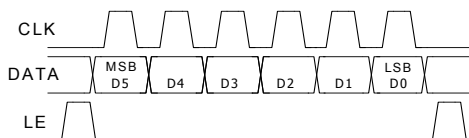

SPI Timing Diagram Specifications

Parameter	Limit	Unit	Comment
t1	25	MHz max	CLK Frequency
t2	20	ns min	CLK High
t3	20	ns min	CLK Low
t4	5	ns min	DATA to CLK Setup Time
t5	5	ns min	DATA to CLK Hold Time
t6	30	ns min	DATA Valid
t7	5	ns min	LE to CLK Setup Time
t8	5	ns min	CLK to LE Setup Time
t9	10	ns min	LE Pulse Width
t10	20	ns max	Output Set

State	Logic
Low	0V to 0.8V
High	2.0V to 5.0V

PUP	Attenuator Setting
Low	Attenuation at Min, 0dB
High	Attenuation at Max, 31.5dB

Pin Names and Descriptions

Pin	Function	Description
1	SPI_LE	Serial Latch Enable Input
2	SPI_DATA	Serial Data Input
3	SPI_CLK	Serial Clock Input
4	PUP	Power-up Programming Pin
5	GND	RF/DC Ground Connection
6	RF_IN	RF Input
7	GND	RF/DC Ground Connection
8	VCC_AMP1	Supply Voltage for Amplifier 1
9	GND	RF/DC Ground Connection
10	GND	RF/DC Ground Connection
11	GND	RF/DC Ground Connection
12	GND	RF/DC Ground Connection
13	GND	RF/DC Ground Connection
14	VCC_AMP2	Supply Voltage for Amplifier 2
15	GND	RF/DC Ground Connection
16	RF_OUT	RF Output
17	GND	RF/DC Ground Connection
18	GND	RF/DC Ground Connection
19	GND	RF/DC Ground Connection
20	GND	RF/DC Ground Connection
21	GND	RF/DC Ground Connection
22	NC	Do Not Connect, Leave Open Circuit
23	GND	RF/DC Ground Connection
24	GND	RF/DC Ground Connection
25	GND	RF/DC Ground Connection
26	GND	RF/DC Ground Connection
27	GND	RF/DC Ground Connection
28	VCC_SPI	Supply Voltage for SPI and DSA Chip

Package Drawing

6.0mm x 6.0mm Laminate Module

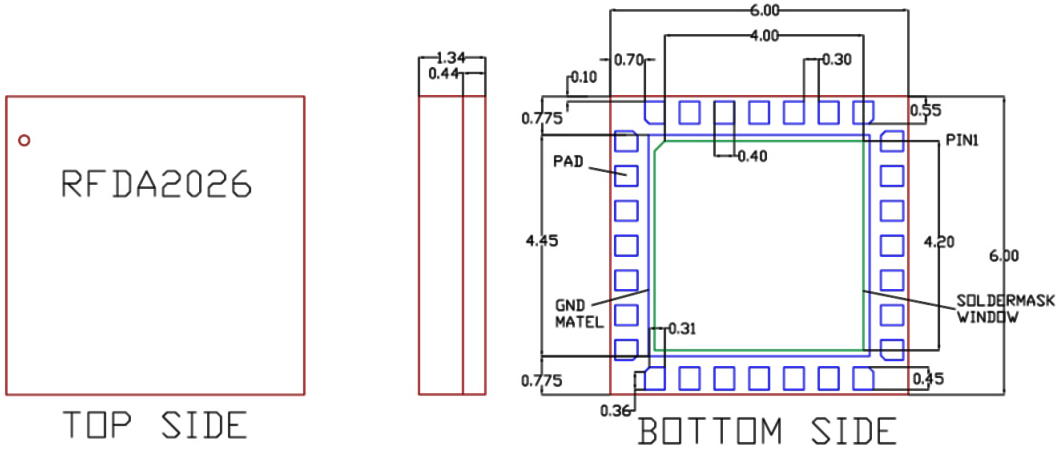

The module thickness tolerance is +/- .04 mm. All other dim tolerances are +/- .075 mm unless otherwise noted.

Branding Diagram

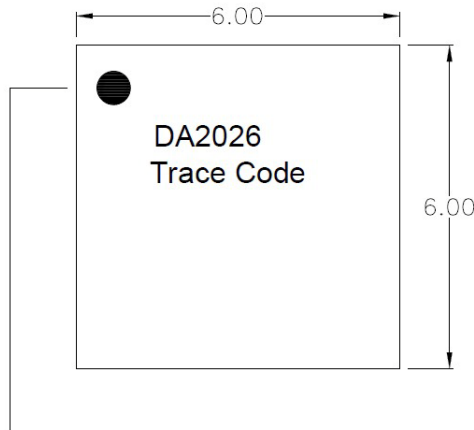

Pin 1 Indicator

Trace Code to be assigned by SubCon

Evaluation Board Schematic 1400MHz to 2400MHz Application Circuit

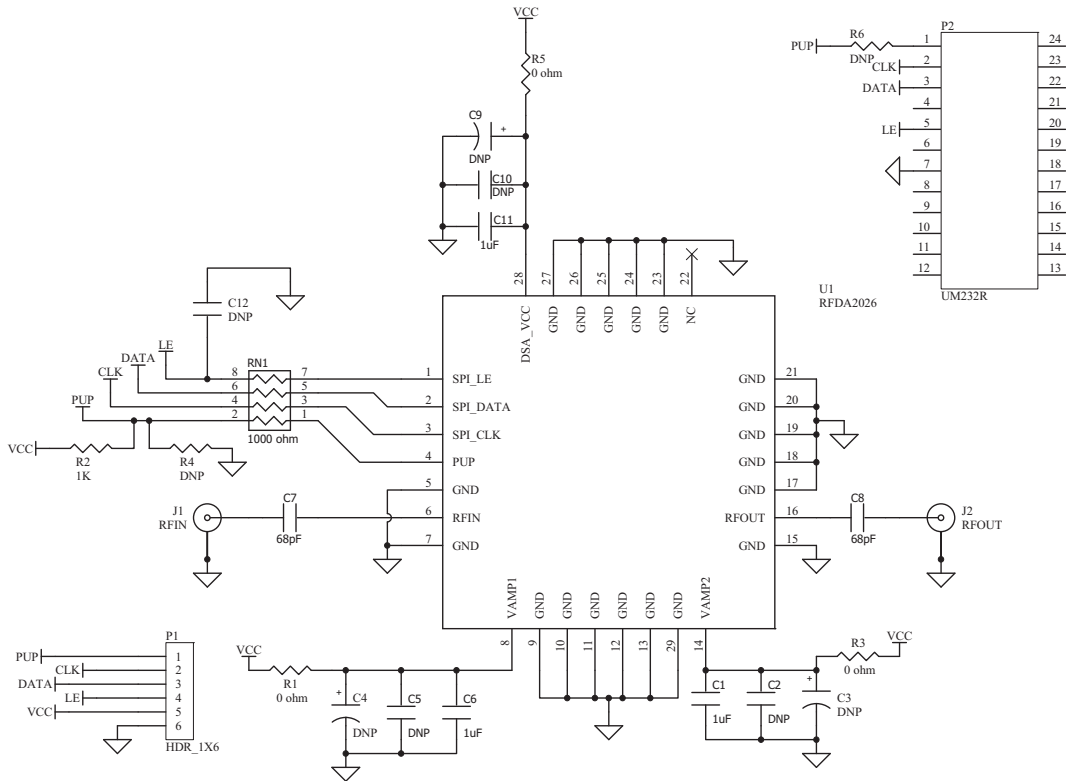

Evaluation Board Bill of Materials (BOM)

1400 MHz to 2400 MHz Application Circuit

Description	Reference Designator	Manufacturer	Manufacturer's P/N
RFDA2026-410(B)		Viasystems	RFDA2026-410(B)
CAP, 1uF, 10%, 10V, X5R, 0402	C1, C6, C11	Murata Electronics	GRM155R61A105KE15D
DNP	C2-C5, C9-C10, C12		
CAP, 68pF, 5%, 50V, C0G, 0402	C7-C8	Murata Electronics	GRM1555C1H680JZ01D
CONN, SMA, END LNCH, FLT, 0.062"	J1-J2	Emerson Network Power	142-0701-821
CONN, HDR, ST, PLRZD, 6-PIN, 0.100"	P1	AMP	640454-6
CONN, SKT, 24-PIN DIP, .600", T/H	P2	Aries Electronics, Inc.	24-6518-10
Res, 0.0, 1/16W, 5%, 0603	R1, R3, R5	Panasonic Industrial Co.	ERJ-3GSY0R00V
RES, 1K, 5%, 1/16W, 0603	R2	Panasonic Industrial Co.	ERJ-3GEYJ102
DNP	R4, R6		
RES ARRAY, 4-ELEM, 1K, 5%, SMD 4x0402	RN1	KOA Speer Electronics, Inc.	CN1E4KTTD102J
DUT	U1	RFMD	RFDA2026-410

Evaluation Board Assembly Drawing 1400MHz to 2400MHz Application Circuit

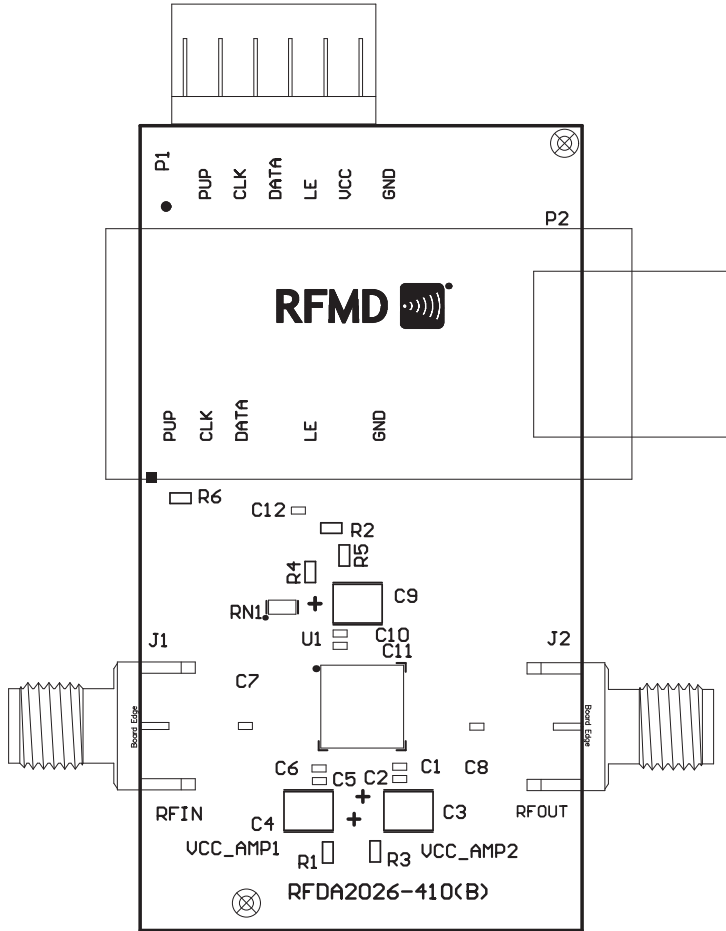

Evaluation Board Schematic 2400MHz to 2700MHz Application Circuit

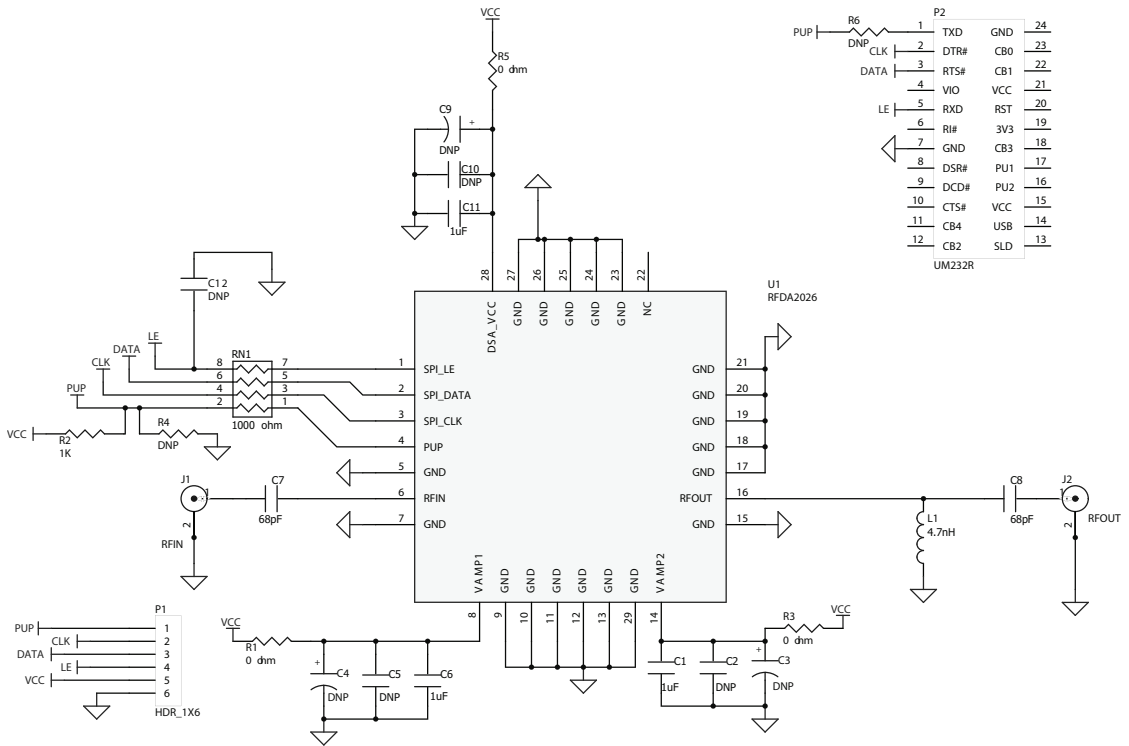

Evaluation Board Bill of Materials (BOM) 2400MHz to 2700MHz Application Circuit

Description	Reference Designator	Manufacturer	Manufacturer's P/N
RFDA2026-411(B)		Viasystems	RFDA2026-411(B)
CAP, 1uF, 10%, 10V, X5R, 0402	C1, C6, C11	Murata Electronics	GRM155R61A105KE15D
DNP	C2-C5, C9-C10, C12		
CAP, 68pF, 5%, 50V, COG, 0402	C7-C8	Murata Electronics	GRM1555C1H680JZ01D
CONN, SMA, END LNCH, FLT, 0.062"	J1-J2	Emerson Network Power	142-0701-821
CONN, HDR, ST, PLRZD, 6-PIN, 0.100"	P1	AMP	640454-6
CONN, SKT, 24-PIN DIP, .600", T/H	P2	Aries Electronics Inc.	24-6518-10
Res, 0.0, 1/16W, 5%, 0603	R1, R3, R5	Panasonic Industrial Co.	ERJ-3GSYOR00V
RES, 1K, 5%, 1/16W, 0603	R2	Panasonic Industrial Co.	ERJ-3GEYJ102
DNP	R4, R6		
IND, 4.7nH, +/-0.3nH, 0603	L1	Toko SH Waigaoqiao F.T.Z. Inc.	LL1608-FSL4N7S
RES ARRAY, 4-ELEM, 1K, 5%, SMD 4x0402	RN1	KOA Speer Electronics, Inc.	CN1E4KTTD102J
DUT	U1	RFMD	RFDA2026-411

Evaluation Board Assembly Drawing 2400MHz to 2700MHz Application Circuit

