

# RFH25P08, RFH25P10, RFK25P08, RFK25P10

-25A, -100V and -80V, 0.150 Ohm,  
P-Channel Power MOSFETs

September 1998

## Features

- -25A, -100V and -80V
- $r_{DS(ON)} = 0.150\Omega$
- Related Literature
  - TB334 "Guidelines for Soldering Surface Mount Components to PC Boards"

## Ordering Information

PART NUMBER	PACKAGE	BRAND
RFH25P08	TO-218AC	RFH25P08
RFH25P10	TO-218AC	RFH25P10
RFK25P08	TO-204AE	RFK25P08
RFK25P10	TO-204AE	RFK25P10

NOTE: When ordering, use the entire part number.

## Description

These are P-Channel enhancement mode silicon gate power field effect transistors designed for applications such as switching regulators, switching converters, motor drivers, relay drivers and drivers for high power bipolar switching transistors requiring high speed and low gate drive power. These types can be operated directly from integrated circuits.

Formerly developmental type TA49230.

## Symbol

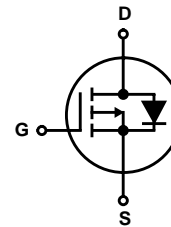

## Packaging

JEDEC TO -218AC

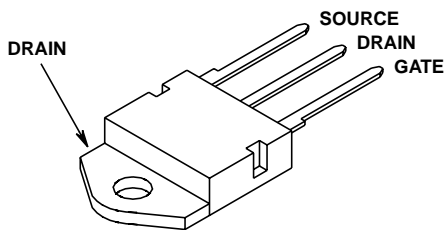

JEDEC TO-204AE

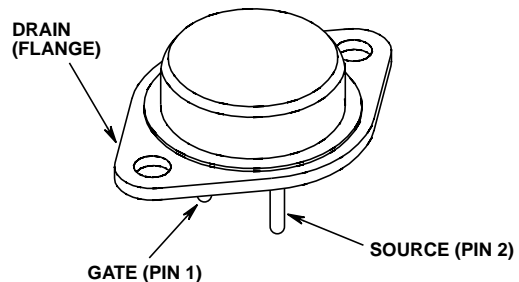

## RFH25P08, RFH25P10, RFK25P08, RFK25P10

### Absolute Maximum Ratings $T_C = 25^\circ\text{C}$ , Unless Otherwise Specified

	RFH25P08 RFK25P08	RFH25P10 RFK25P10	UNITS	
Drain to Source Voltage (Note 1) . . . . .	$V_{DS}$	-80	-100	V
Drain to Gate Voltage ( $R_{GS} = 20\text{k}\Omega$ ) (Note 1) . . . . .	$V_{DGR}$	-80	-100	V
Continuous Drain Current. . . . .	$I_D$	-25	-25	A
Pulsed Drain Current (Note 3) . . . . .	$I_{DM}$	-60	-60	A
Gate to Source Voltage . . . . .	$V_{GS}$	$\pm 20$	$\pm 20$	V
Maximum Power Dissipation . . . . .	$P_D$	150	150	W
Linear Derating Factor . . . . .		1.2	1.2	W/ $^\circ\text{C}$
Operating and Storage Temperature . . . . .	$T_J, T_{STG}$	-55 to 150	-55 to 150	$^\circ\text{C}$
Maximum Temperature for Soldering				
Leads at 0.063in (1.6mm) from Case for 10s . . . . .	$T_L$	300	300	$^\circ\text{C}$
Package Body for 10s, See Techbrief 334 (for TO-218AC). . . . .	$T_{pkg}$	260	260	$^\circ\text{C}$

*CAUTION: Stresses above those listed in "Absolute Maximum Ratings" may cause permanent damage to the device. This is a stress only rating and operation of the device at these or any other conditions above those indicated in the operational sections of this specification is not implied.*

**NOTE:**

- $T_J = 25^\circ\text{C}$  to  $125^\circ\text{C}$ .

### Electrical Specifications $T_C = 25^\circ\text{C}$ , Unless Otherwise Specified

PARAMETER	SYMBOL	TEST CONDITIONS	MIN	TYP	MAX	UNITS
Drain to Source Breakdown Voltage RFH25P08, RFK25P08	$BV_{DSS}$	$I_D = 250\mu\text{A}, V_{GS} = 0\text{V}$	-80	-	-	V
			-100	-	-	V
RFH25P10, RFK25P10						
Gate Threshold Voltage	$V_{GS(TH)}$	$V_{GS} = V_{DS}, I_D = 250\mu\text{A}$ , (Figure 8)	-2	-	-4	V
Zero Gate Voltage Drain Current	$I_{DSS}$	$V_{DS} = \text{Rated } BV_{DSS}, V_{GS} = 0$ $V_{DS} = 0.8 \times \text{Rated } BV_{DSS}, V_{GS} = 0,$ $T_C = 125^\circ\text{C}$	-	-	-1	$\mu\text{A}$
			-	-	-25	$\mu\text{A}$
Gate to Source Leakage Current	$I_{GSS}$	$V_{GS} = \pm 20\text{V}, V_{DS} = 0\text{V}$	-	-	$\pm 100$	nA
Drain to Source On Resistance (Note 2)	$r_{DS(ON)}$	$I_D = 25\text{A}, V_{GS} = -10\text{V}$ , (Figures 6, 7)	-	-	0.150	$\Omega$
Drain to Source On Voltage (Note 2)	$V_{DS(ON)}$	$I_D = -25\text{A}, V_{GS} = -10\text{V}$	-	-	-3.75	V
Turn-On Delay Time	$t_{d(ON)}$	$I_D \approx 12.5\text{A}, V_{DS} = -50\text{V}, R_{GS} = 50\Omega,$ $V_{GS} = -10\text{V}, R_L = 4.0\Omega$ (Figures 10, 11, 12)	-	35	50	ns
Rise Time	$t_r$		-	165	250	ns
Turn-Off Delay Time	$t_{d(OFF)}$		-	270	400	ns
Fall Time	$t_f$		-	165	250	ns
Input Capacitance	$C_{ISS}$	$V_{GS} = 0\text{V}, V_{DS} = -25\text{V}, f = 1\text{MHz}$ (Figure 9)	-	-	3000	pF
Output Capacitance	$C_{OSS}$		-	-	1500	pF
Reverse-Transfer Capacitance	$C_{RSS}$		-	-	600	pF
Thermal Resistance Junction to Case	$R_{\theta JC}$	RFK25P08, RFK25P10	-	-	0.83	$^\circ\text{C/W}$

### Source to Drain Diode Specifications

PARAMETER	SYMBOL	TEST CONDITIONS	MIN	TYP	MAX	UNITS
Source to Drain Diode Voltage (Note 2)	$V_{SD}$	$I_{SD} = -12.5\text{A}$	-	-	-1.4	V
Diode Reverse Recovery Time	$t_{rr}$	$I_{SD} = -4\text{A}, dI_{SD}/dt = 100\text{A}/\mu\text{s}$	-	300	-	ns

**NOTES:**

- Pulse test: pulse width  $\leq 300\mu\text{s}$ , duty cycle  $\leq 2\%$ .
- Repetitive rating: pulse width limited by maximum junction temperature.

Typical Performance Curves Unless Otherwise Specified

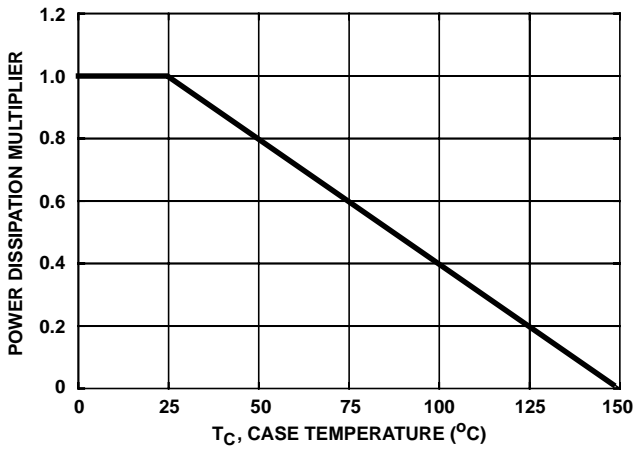

FIGURE 1. NORMALIZED POWER DISSIPATION vs CASE TEMPERATURE

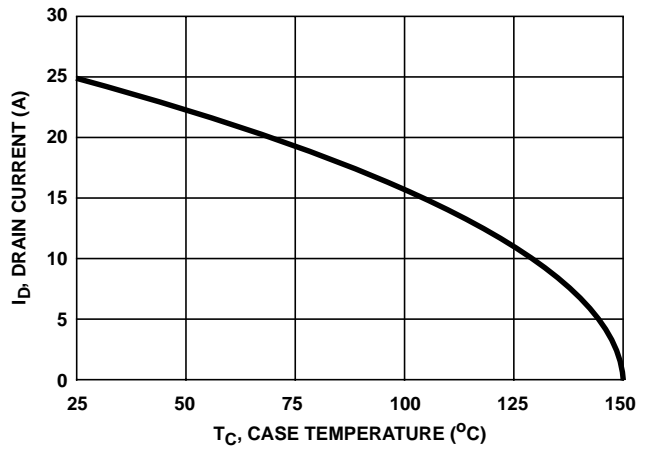

FIGURE 2. MAXIMUM CONTINUOUS DRAIN CURRENT vs CASE TEMPERATURE

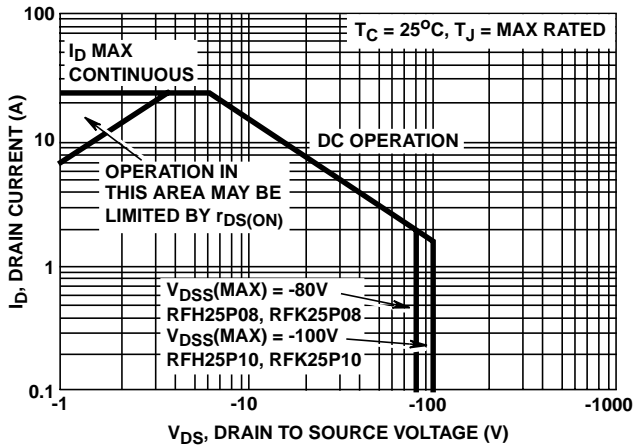

FIGURE 3. FORWARD BIAS SAFE OPERATING AREA

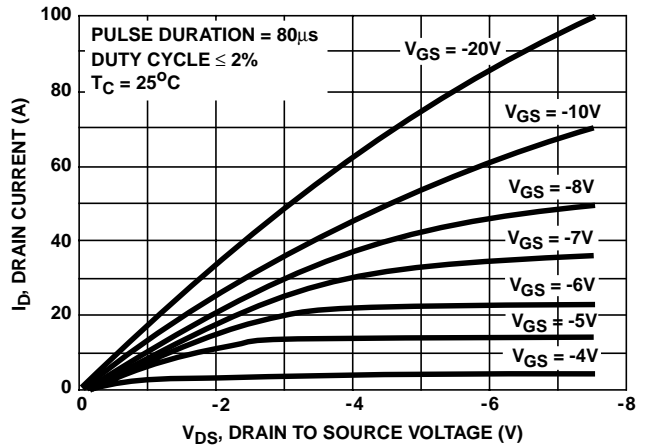

FIGURE 4. SATURATION CHARACTERISTICS

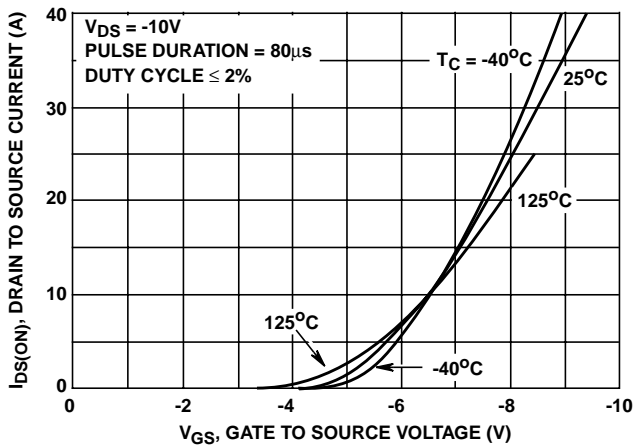

FIGURE 5. TRANSFER CHARACTERISTICS

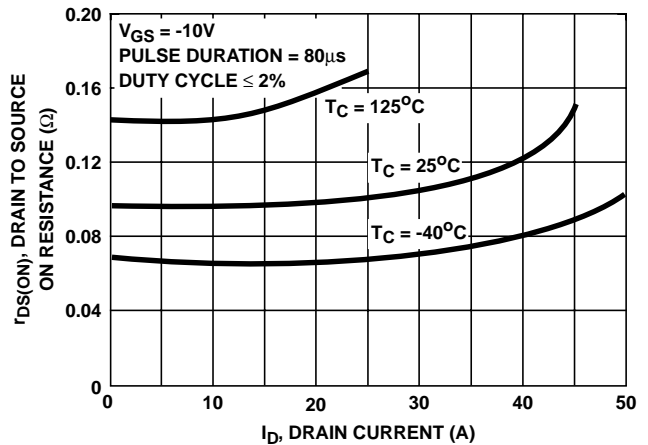

FIGURE 6. DRAIN TO SOURCE ON RESISTANCE vs DRAIN CURRENT

**Typical Performance Curves** Unless Otherwise Specified (Continued)

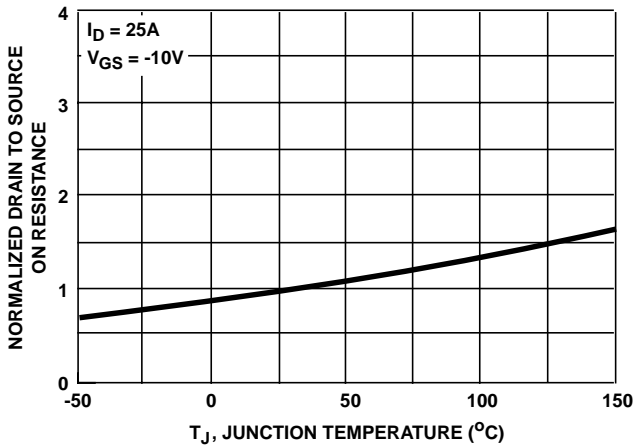

FIGURE 7. NORMALIZED DRAIN TO SOURCE ON RESISTANCE vs JUNCTION TEMPERATURE

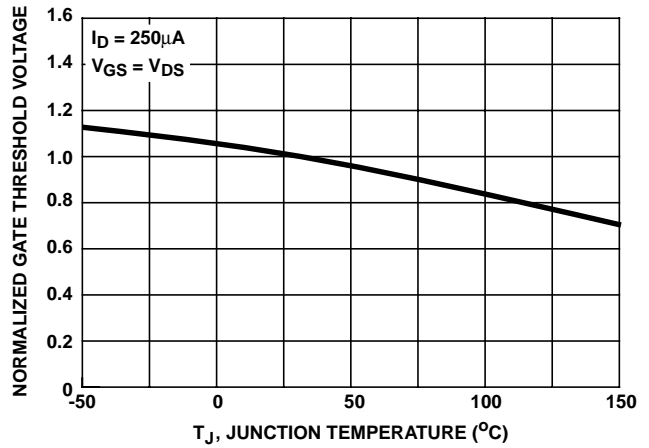

FIGURE 8. NORMALIZED GATE THRESHOLD VOLTAGE vs JUNCTION TEMPERATURE

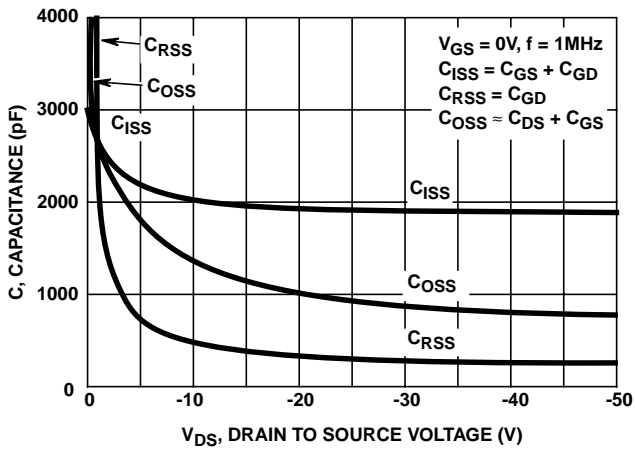
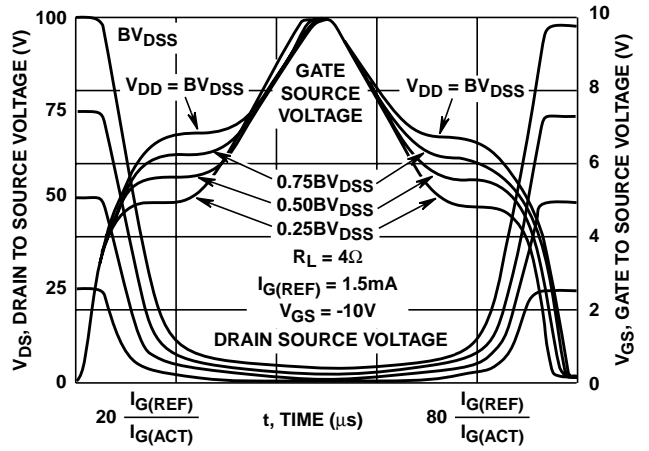

FIGURE 9. CAPACITANCE vs DRAIN TO SOURCE VOLTAGE



NOTE: Refer to Harris Application Notes AN7254 and AN7260.

FIGURE 10. NORMALIZED SWITCHING WAVEFORMS FOR CONSTANT GATE CURRENT

**Test Circuits and Waveforms**

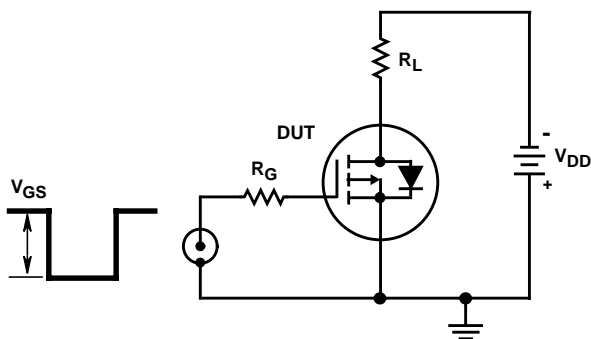

FIGURE 11. SWITCHING TIME TEST CIRCUIT

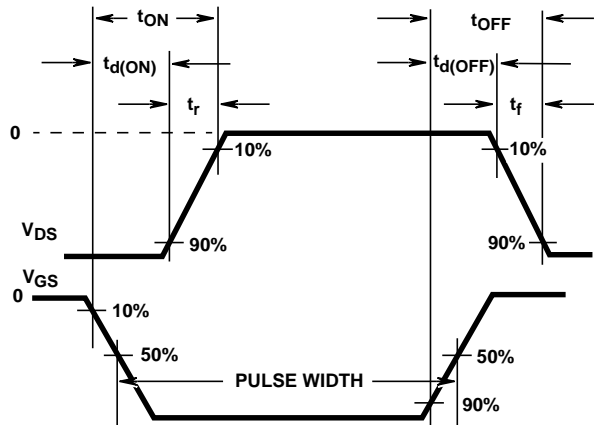

FIGURE 12. RESISTIVE SWITCHING WAVEFORMS