



### Features

- ACPR Performance: -70dBc Typ. for 1-Carrier WCDMA
- Very High Linearity: +26dBm OIP3
- Very Low Noise Floor: -160dBm/Hz
- High Output Power: +11dBm P1dB
- Typical Carrier Feed-Through: <-40dBm
- Single-Ended or Differential LO Drive
- Typical Sideband Suppression: <-40dBc
- Single +5V Supply
- Small 24-Pin, 4mmx4mm, QFN

### Applications

- Cellular, 3G Infrastructure
- WiBro, WiMax, LTE
- WiFi or WLL Systems
- GMSK, QPSK, DQPSK, QAM Modulation

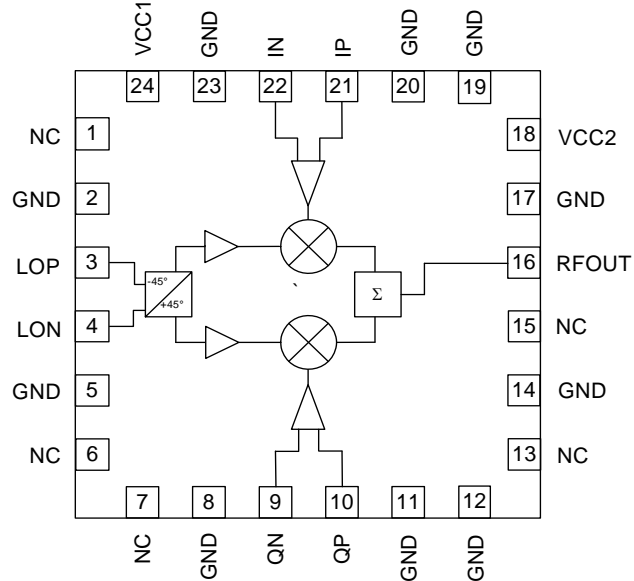

Functional Block Diagram

### Product Description

The RFMD2014 is direct quadrature modulator for use in cellular base stations and other communications systems. RFMD2014 supports cellular, 3G, WiMax, and LTE air interface standards. This device features operation from 1450MHz to 2700MHz with excellent carrier and sideband suppression and ultra low noise floor. The device is manufactured in an advanced GaAs HBT process. The RFMD2014 operates from a single 5V supply and is packaged in a low cost, 4mm x 4mm, 24-pin leadless package.

### Optimum Technology Matching® Applied

- |   |                                      |                                     |                                    |
|---|--------------------------------------|-------------------------------------|------------------------------------|
| <input type="checkbox"/> GaAs HBT             | <input type="checkbox"/> SiGe BiCMOS | <input type="checkbox"/> GaAs pHEMT | <input type="checkbox"/> GaN HEMT  |
| <input type="checkbox"/> GaAs MESFET          | <input type="checkbox"/> Si BiCMOS   | <input type="checkbox"/> Si CMOS    | <input type="checkbox"/> BiFET HBT |
| <input checked="" type="checkbox"/> InGaP HBT | <input type="checkbox"/> SiGe HBT    | <input type="checkbox"/> Si BJT     | <input type="checkbox"/> LDMOS     |

RF MICRO DEVICES®, RFMD®, Optimum Technology Matching®, Enabling Wireless Connectivity™, PowerStar®, POLARIS™ TOTAL RADIO™ and UltimateBlue™ are trademarks of RFMD, LLC. BLUETOOTH is a trademark owned by Bluetooth SIG, Inc., U.S.A. and licensed for use by RFMD. All other trade names, trademarks and registered trademarks are the property of their respective owners. ©2011, RF Micro Devices, Inc.

## Absolute Maximum Ratings

Parameter	Rating	Unit
Supply Voltage	5.5	V
LO Input	+10	dBm
Operating Temperature	-40 to +85	°C
Storage Temperature	-65 to +150	°C
Maximum Junction Temperature	+150	°C
Power Dissipation	1200	mW
BB CM Voltage	1.8	V
Thermal Resistance	28	°C/W
ESD	Class 1 C (1000V)	



**Caution!** ESD sensitive device.

Exceeding any one or a combination of the Absolute Maximum Rating conditions may cause permanent damage to the device. Extended application of Absolute Maximum Rating conditions to the device may reduce device reliability. Specified typical performance or functional operation of the device under Absolute Maximum Rating conditions is not implied.

The information in this publication is believed to be accurate and reliable. However, no responsibility is assumed by RF Micro Devices, Inc. ("RFMD") for its use, nor for any infringement of patents, or other rights of third parties, resulting from its use. No license is granted by implication or otherwise under any patent or patent rights of RFMD. RFMD reserves the right to change component circuitry, recommended application circuitry and specifications at any time without prior notice.



RFMD Green: RoHS compliant per EU Directive 2002/95/EC, halogen free per IEC 61249-2-21, < 1000ppm each of antimony trioxide in polymeric materials and red phosphorus as a flame retardant, and <2% antimony in solder.

Parameter	Specification			Unit	Condition
	Min.	Typ.	Max.		
<b>General</b>					
Supply Voltage	4.75	5	5.25	V	
Supply Current	189	210	231	mA	
<b>RF Output</b>					
RF Frequency Range	1450		2700	MHz	
Carrier Feed through		-40		dBm	Uncalibrated
Sideband Suppression		-40		dB	Uncalibrated
OIP3	23	26		dBm	Baseband input 800mV <sub>pp</sub> , 20kHz Δ
RF Port Return Loss		15		dB	
P <sub>OUT</sub>	-3	0	3	dBm	Baseband input 800mV <sub>pp</sub> , CW quadrature
ACP		-70		dBc	RF output -10dBm, 1 carrier WCDMA
Broadband Noise Floor		-160		dBm/Hz	20MHz offset, BB OV <sub>pp</sub>
Output Power Flatness		0.25		dB	Over 60MHz BW
P1dB	9	11		dBm	
<b>LO Input</b>					
LO Frequency Range	1450		2700	MHz	
LO Input Power	-3	0	3	dBm	
Return Loss		15		dB	
<b>BB Input</b>					
I/Q Input Frequency Range	DC		300	MHz	
BB Input Impedance		600		Ω	Differential impedance
Common Mode Voltage		1.5		V	

Note: Typical performance at nominal conditions unless otherwise noted: VCC=+5V, Temperature=+25°C, Baseband CM Voltage=+1.5V, LO Frequency=2100MHz, LO Power=0dBm, Single-Ended

Pin	Function	Description
1	NC	No connection.
2	GND	RF/DC Ground connection.
3	LOP	Local oscillator differential input.
4	LON	Local oscillator differential input. Connect to ground when using LOP input in single ended mode.
5	GND	RF/DC Ground connection.
6	NC	No connection.
7	NC	No connection.
8	GND	RF/DC Ground connection.
9	QN	Q channel differential baseband input.
10	QP	Q channel differential baseband input.
11	GND	RF/DC Ground connection.
12	GND	RF/DC Ground connection.
13	NC	No connection.
14	GND	RF/DC Ground connection.
15	NC	No connection.
16	RFOUT	RF single-ended output.
17	GND	RF/DC Ground connection.
18	VCC2	5V supply.
19	GND	RF/DC Ground connection.
20	GND	RF/DC Ground connection.
21	IP	I channel differential baseband input.
22	IN	I channel differential baseband input.
23	GND	RF/DC Ground connection.
24	VCC1	5V supply.

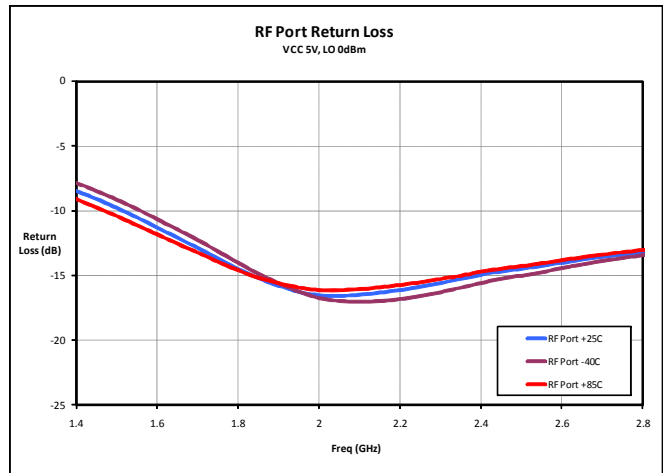
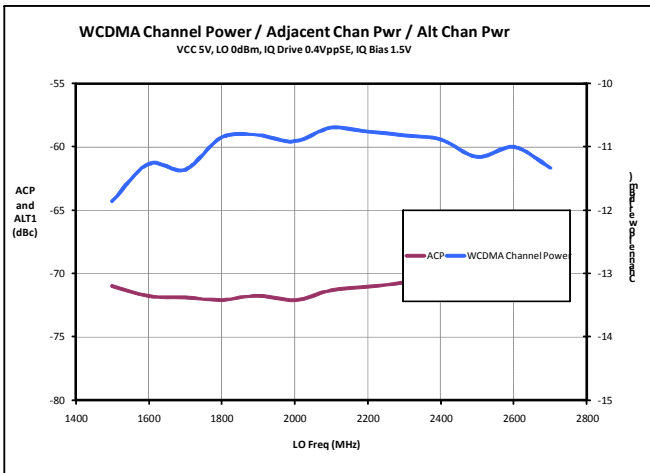
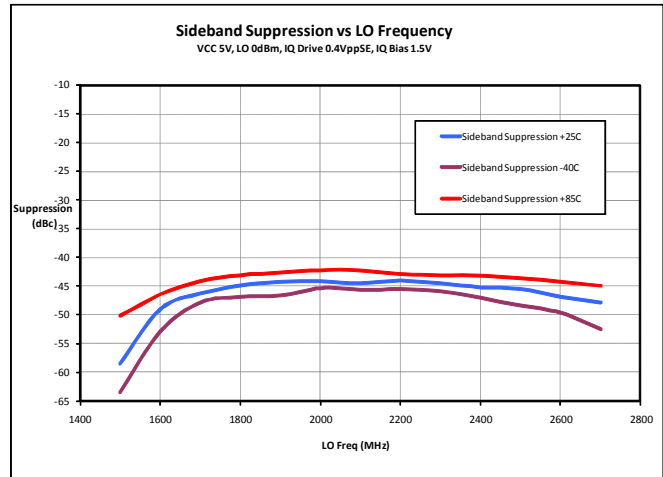
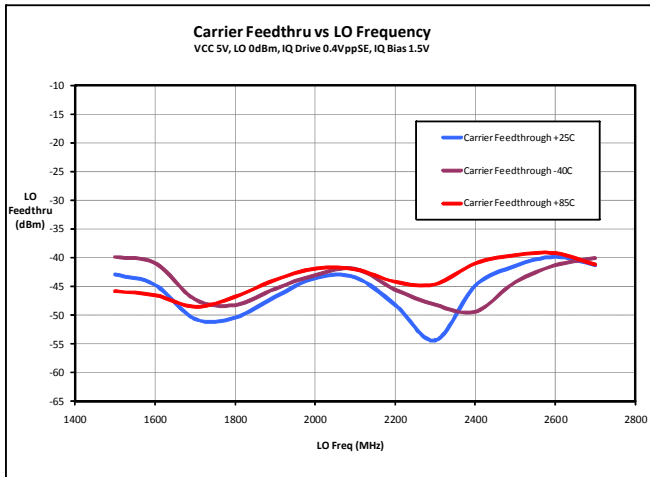
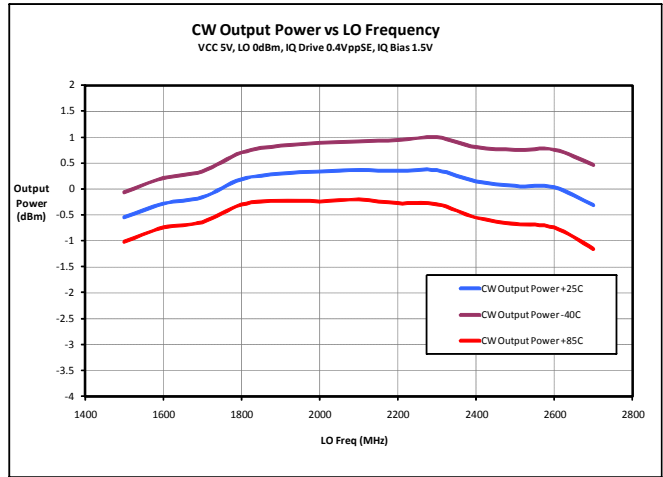
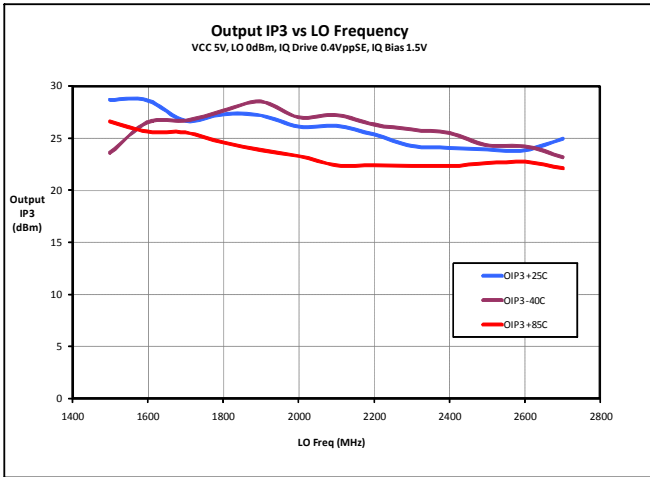

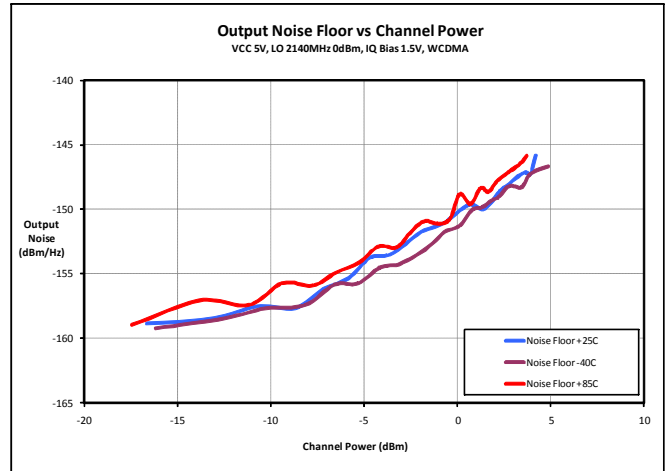
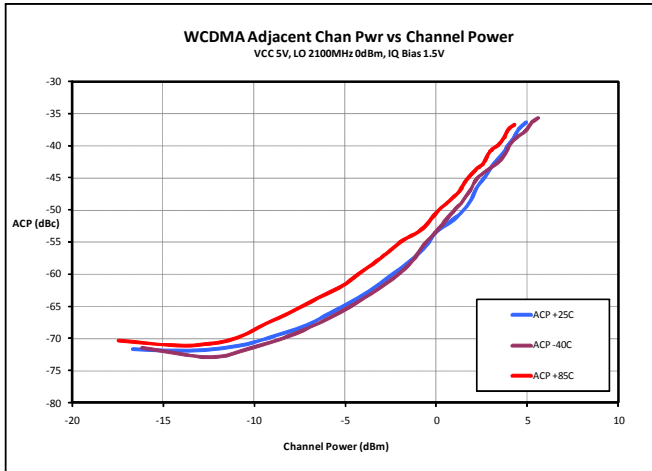
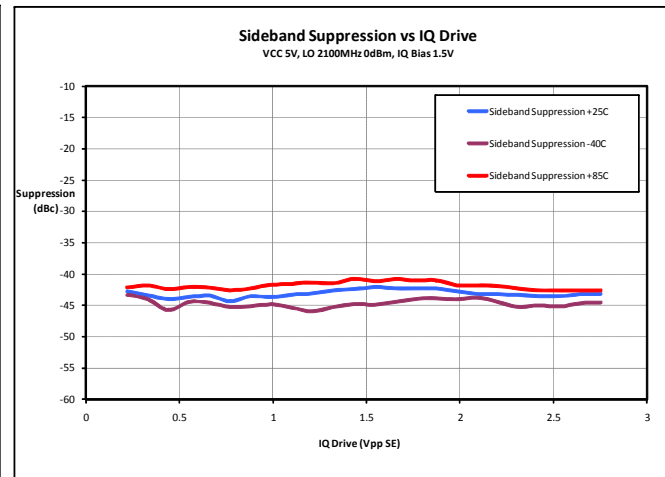
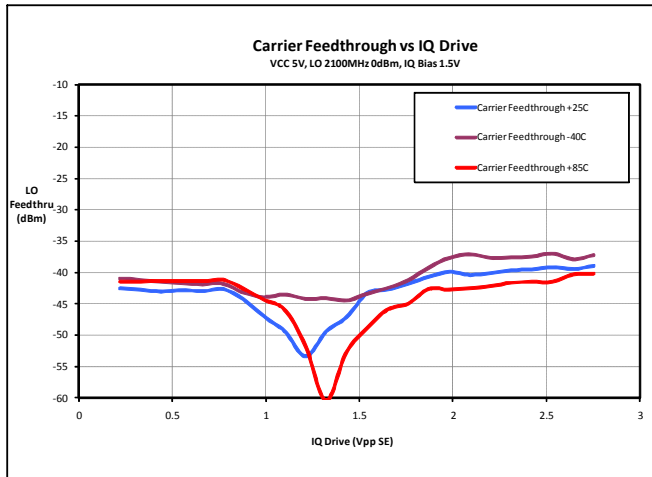
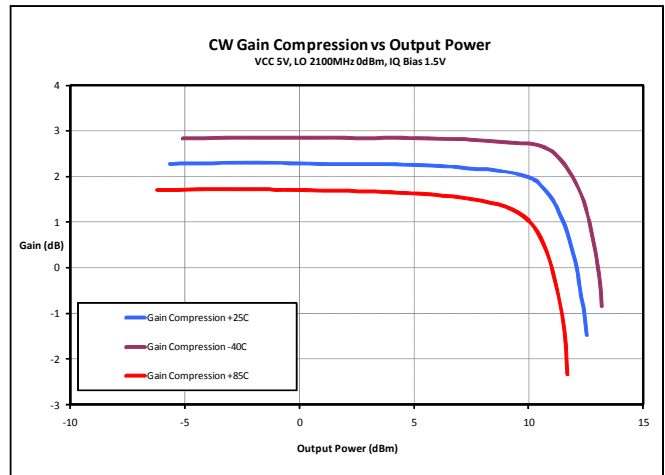
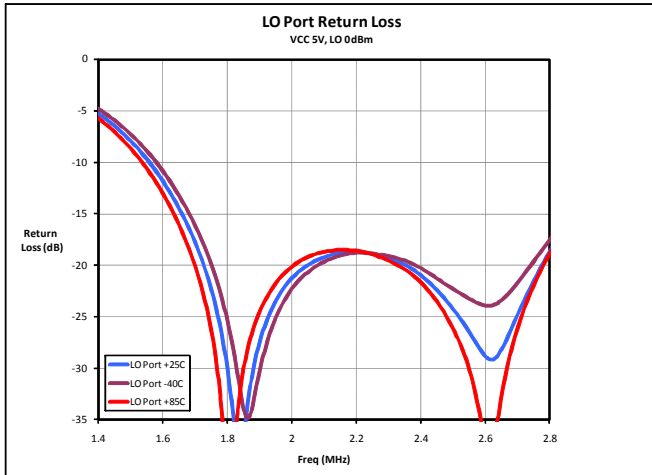

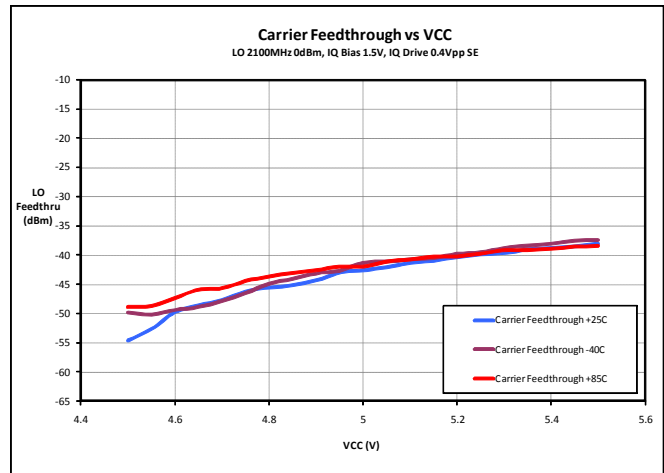
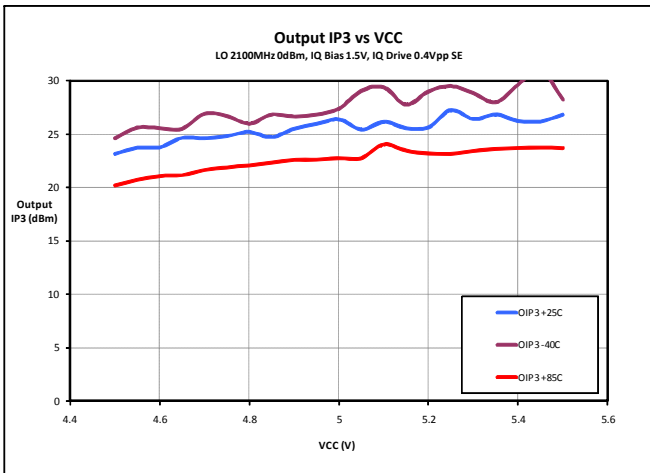
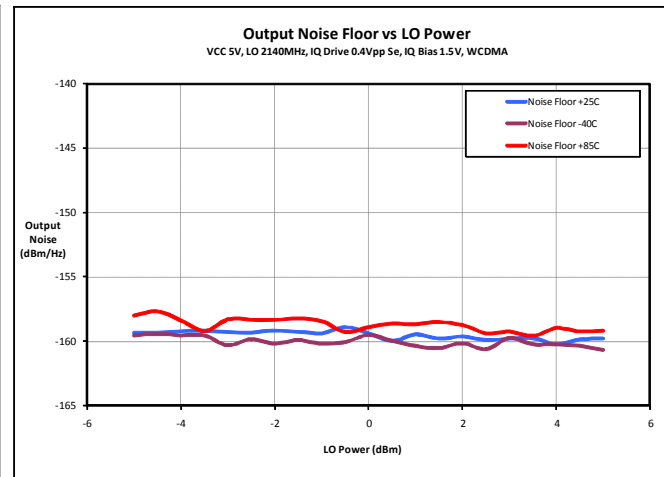
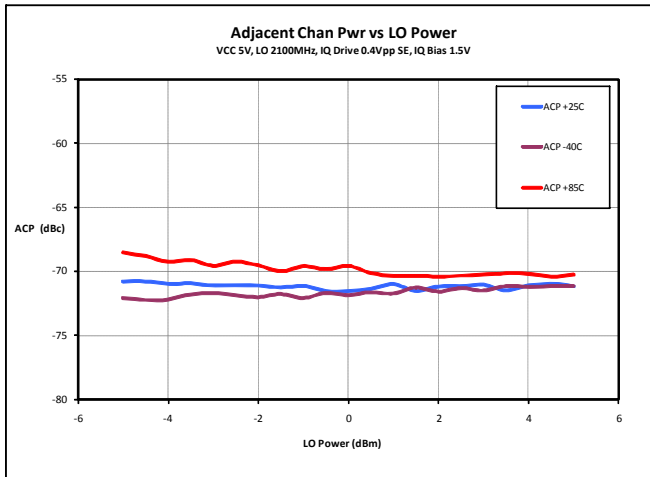
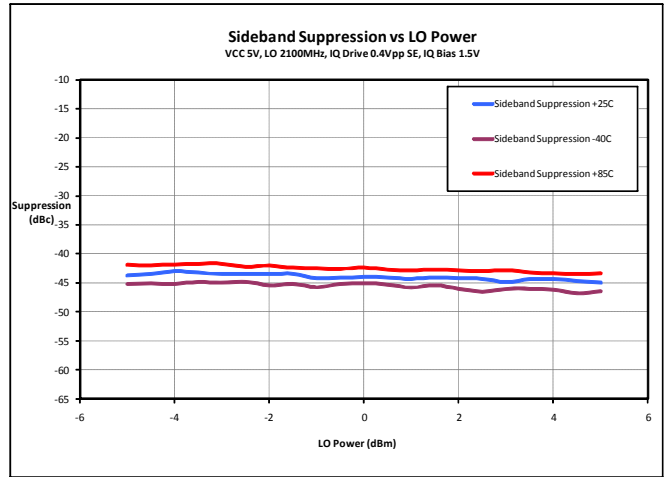
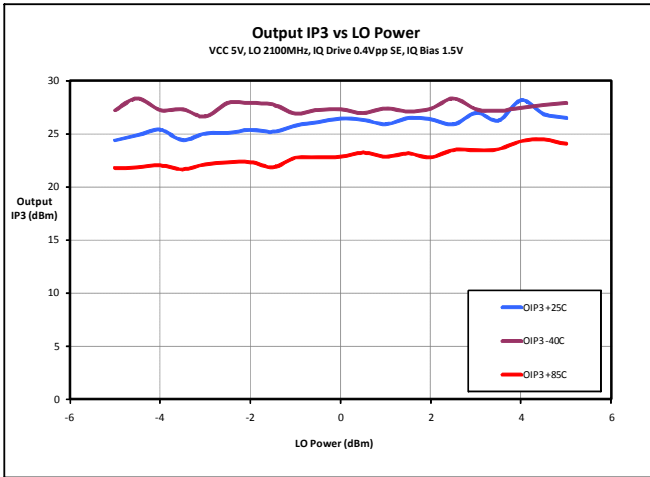

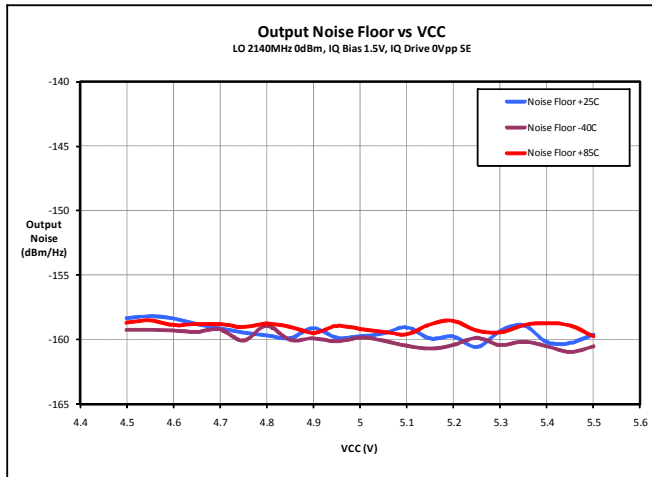
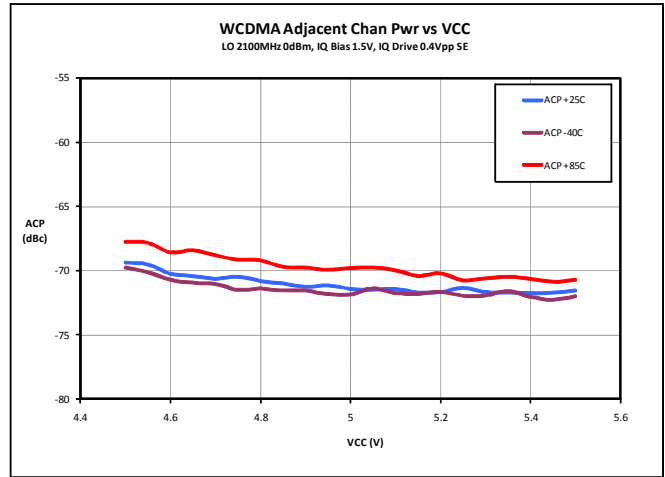
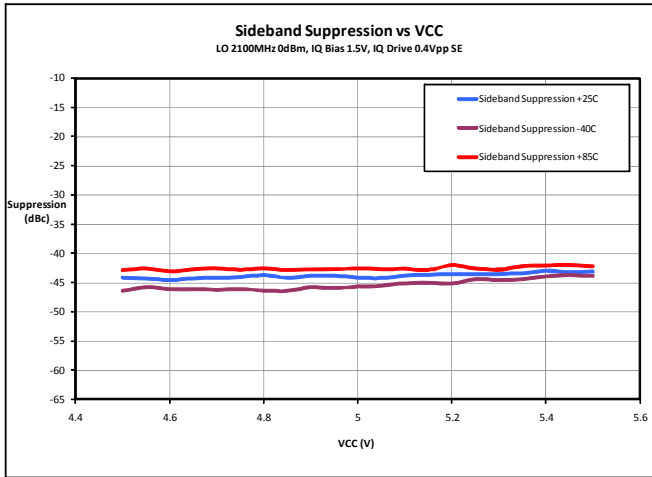

## Evaluation Board Schematic

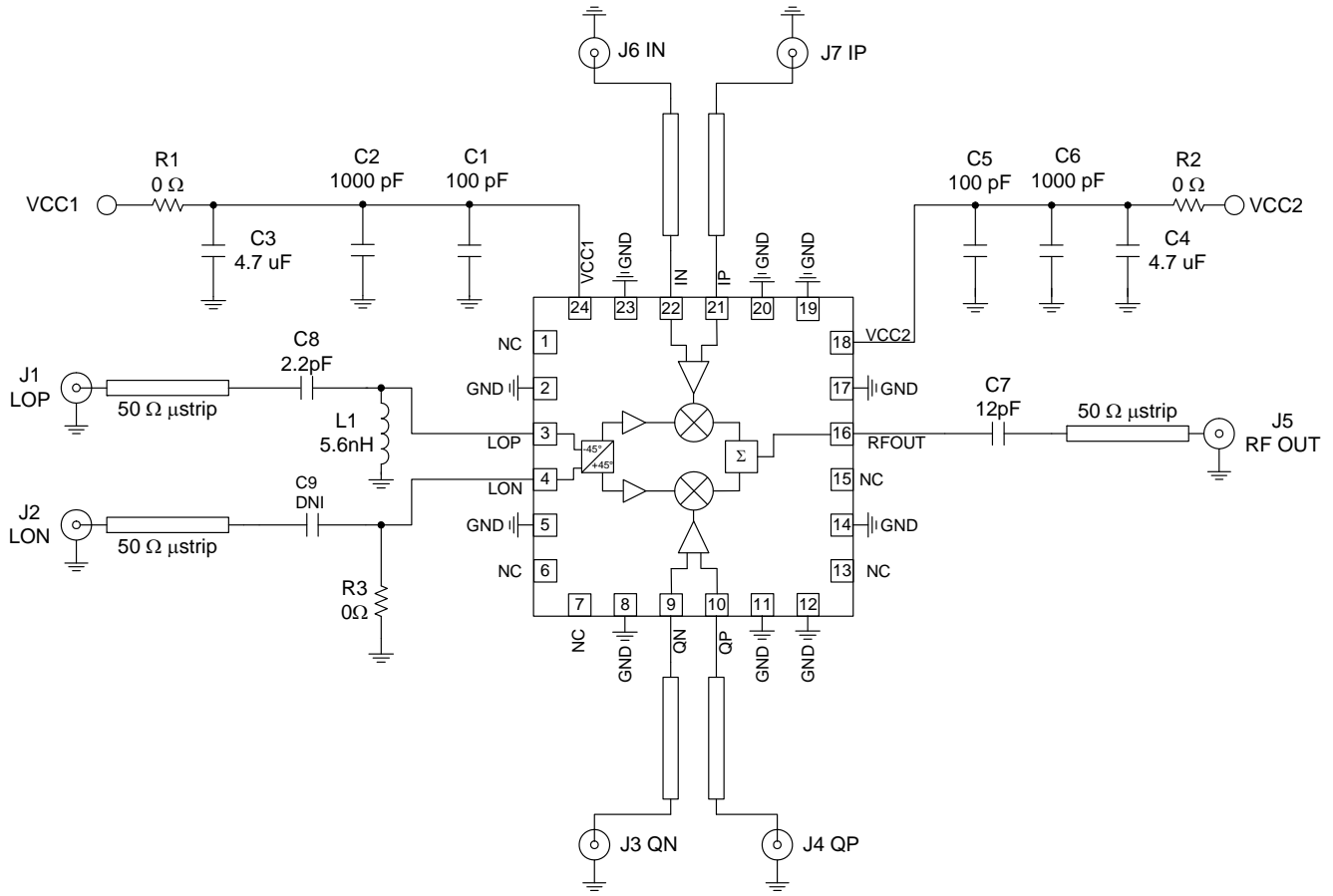

Note: Evaluation board configured for single-ended LO drive using LOP connector. Terminate the LON pin to ground near the package.



Evaluation Board Layout

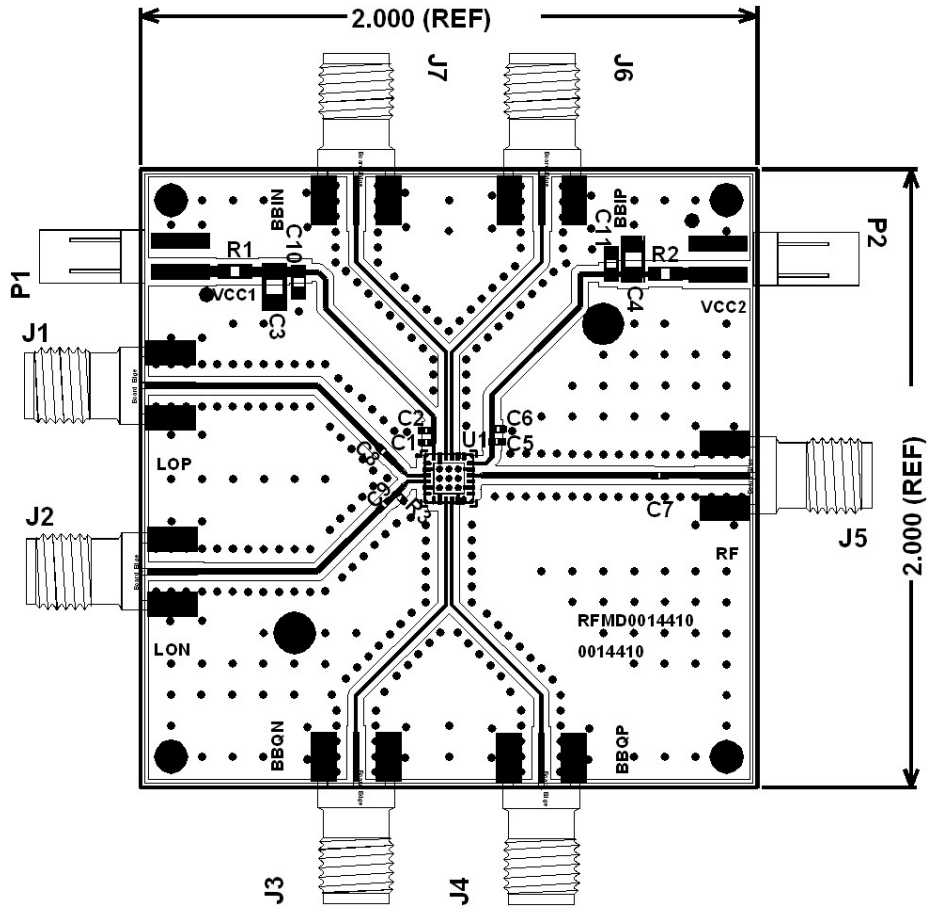

## Package Drawing QFN, 24-pin, 4mm x 4mm

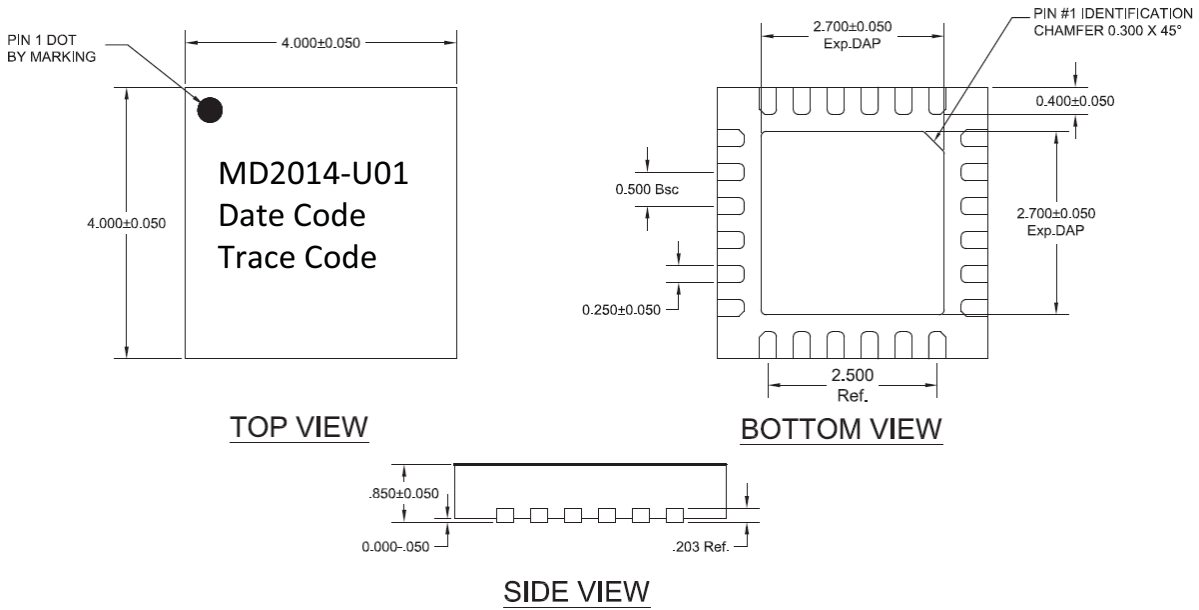

## Branding Diagram

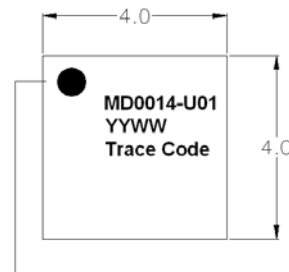

Pin 1 Indicator

YYWW Date Code Notation

YY = Year

WW = Week

Trace Code for tracking

## Ordering Information

Ordering Code	Description
RFMD2014SQ	Sample bag with 25 pieces
RFMD2014SR	7" Reel with 100 pieces
RFMD2014TR7	7" Reel with 750 pieces
RFMD2014TR13	13" Reel with 2500 pieces
RFMD2014PCK-410	1450MHz to 2700MHz PCBA with 5-piece sample bag