

Power Logic Level MOSFETs

N-Channel Logic Level Power Field-Effect Transistors (L² FET)

10 A, 120 V — 150 V

r_{DS(on)}: 0.3 Ω

Features:

- Design optimized for 5 volt gate drive
- Can be driven directly from Q-MOS, N-MOS, TTL Circuits
- Compatible with automotive drive requirements
- SOA is power-dissipation limited
- Nanosecond switching speeds
- Linear transfer characteristics
- High input impedance
- Majority carrier device

TERMINAL DIAGRAM

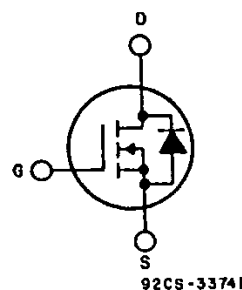

N-CHANNEL ENHANCEMENT MODE

The RFM10N12L and RFM10N15L and the RFP10N12L and RFP10N15L* are N-channel enhancement-mode silicon-gate power field-effect transistors designed for applications such as switching regulators, switching converters, motor drivers, relay drivers, and drivers for high-power bipolar switching transistors requiring high speed and low gate-drive power. These types can be operated directly from integrated circuits.

The RFM-series types are supplied in the JEDEC TO-204AA steel package and the RFP-series types in the JEDEC TO-220AB plastic package.

Because of space limitations branding (marking) on type RFP10N12L is F10N12L and on type RFP10N15L is F10N15L.

*The RFM and RFP series were formerly RCA developmental numbers TA9530 and TA9531, respectively.

TERMINAL DESIGNATIONS

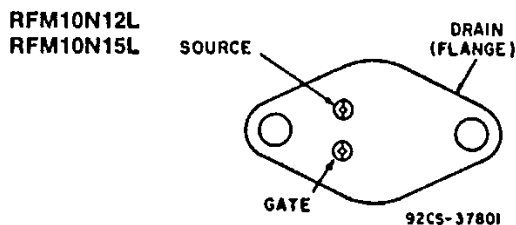

JEDEC TO-204AA

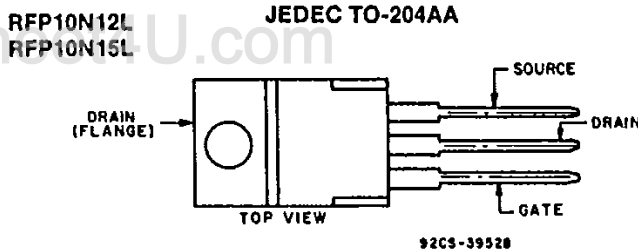

JEDEC TO-220AB

MAXIMUM RATINGS, Absolute-Maximum Values (T_c = 25° C):

	RFM10N12L	RFM10N15L	RFP10N12L	RFP10N15L		
DRAIN-SOURCE VOLTAGE	V _{DSS}	120	150	120	150	V
DRAIN-GATE VOLTAGE (R _{gs} = 1 MΩ)	V _{DGR}	120	150	120	150	V
GATE-SOURCE VOLTAGE	V _{GS}	±10				V
DRAIN CURRENT, RMS Continuous	I _D	10				A
Pulsed	I _{DM}	25				A
POWER DISSIPATION @ T _c = 25° C	P _T	75	75	60	60	W
Derate above T _c = 25° C		0.6	0.6	0.48	0.48	W/°C
OPERATING AND STORAGE TEMPERATURE	T _J , T _{stg}	-55 to +150				°C

ELECTRICAL CHARACTERISTICS, At Case Temperature ($T_C = 25^\circ\text{C}$) unless otherwise specified

CHARACTERISTIC	SYMBOL	TEST CONDITIONS	LIMITS				UNITS
			RFM10N12L RFP10N12L		RFM10N15L RFP10N15L		
			MIN.	MAX.	MIN.	MAX.	
Drain-Source Breakdown Voltage	BV_{DSS}	$I_D = 1\text{ mA}$ $V_{GS} = 0$	120	—	150	—	V
Gate-Threshold Voltage	$V_{GS(th)}$	$V_{GS} = V_{DS}$ $I_D = 2\text{ mA}$	1	2	1	2	V
Zero-Gate Voltage Drain Current	I_{DSS}	$V_{DS} = 100\text{ V}$ $V_{GS} = 120\text{ V}$	—	1	—	—	μA
		$T_C = 125^\circ\text{C}$ $V_{DS} = 100\text{ V}$ $V_{DS} = 120\text{ V}$	—	50	—	50	
Gate-Source Leakage Current	I_{GSS}	$V_{GS} = \pm 10\text{ V}$ $V_{DS} = 0$	—	100	—	100	nA
Drain-Source On Voltage	$V_{DS(on)}^a$	$I_D = 5\text{ A}$ $V_{GS} = 5\text{ V}$	—	1.5	—	1.5	V
		$I_D = 10\text{ A}$ $V_{GS} = 5\text{ V}$	—	4	—	4	
Static Drain-Source On Resistance	$r_{DS(on)}^a$	$I_D = 5\text{ A}$ $V_{GS} = 5\text{ V}$	—	0.3	—	0.3	Ω
Forward Transconductance	g_{fs}^a	$V_{DS} = 10\text{ V}$ $I_D = 5\text{ A}$	4.0	—	4.0	—	mho
Input Capacitance	C_{iss}	$V_{DS} = 25\text{ V}$	—	1200	—	1200	pF
Output Capacitance	C_{oss}	$V_{GS} = 0\text{ V}$	—	250	—	250	
Reverse-Transfer Capacitance	C_{rss}	$f = 1\text{ MHz}$	—	60	—	60	
Turn-On Delay Time	$t_{d(on)}$	$V_{DD} = 75\text{ V}$ $I_D = 5\text{ A}$ $R_{\theta gen} = \infty$ $R_{\theta s} = 6.25\ \Omega$ $V_{GS} = 5\text{ V}$	15(typ)	60	15(typ)	60	ns
Rise Time	t_r		50(typ)	135	50(typ)	135	
Turn-Off Delay Time	$t_{d(off)}$		90(typ)	135	90(typ)	135	
Fall Time	t_f		90(typ)	135	90(typ)	135	
Thermal Resistance Junction-to-Case	$R\theta_{JC}$	RFM10N12L, RFM10N15L	—	1.67	—	1.67	$^\circ\text{C/W}$
		RFP10N12L, RFP10N15L	—	2.083	—	2.083	

SOURCE-DRAIN DIODE RATINGS AND CHARACTERISTICS

CHARACTERISTIC	SYMBOL	TEST CONDITIONS	LIMITS				UNITS
			RFM10N12L RFP10N12L		RFM10N15L RFP10N15L		
			MIN.	MAX.	MIN.	MAX.	
Diode Forward Voltage	V_{SD}^a	$I_{SD} = 5\text{ A}$	—	1.4	—	1.4	V
Reverse Recovery Time	t_{rr}	$I_F = 4\text{ A}$, $dI_F/dt = 100\text{ A}/\mu\text{s}$	150 (typ.)		150 (typ.)		ns

^a Pulse Test: Width $\leq 300\ \mu\text{s}$, Duty cycle $\leq 2\%$

RFM10N12L, RFM10N15L, RFP10N12L, RFP10N15L

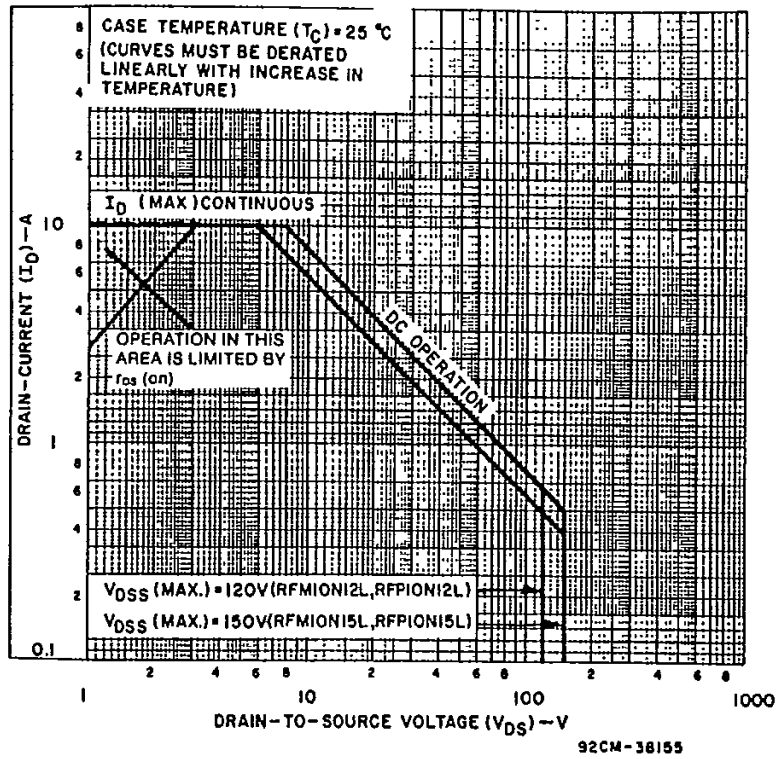

Fig. 1 - Maximum safe operating areas for all types.

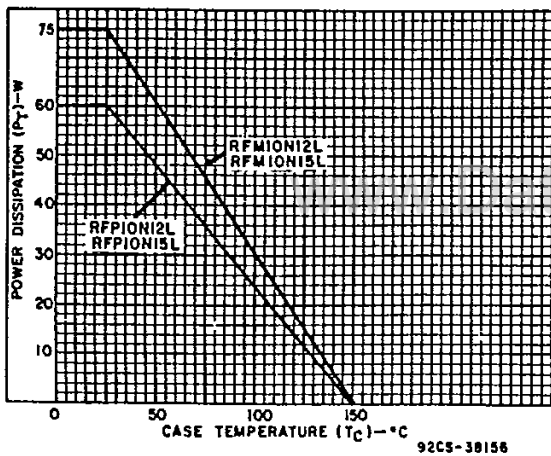

Fig. 2 - Power vs. temperature derating curve for all types.

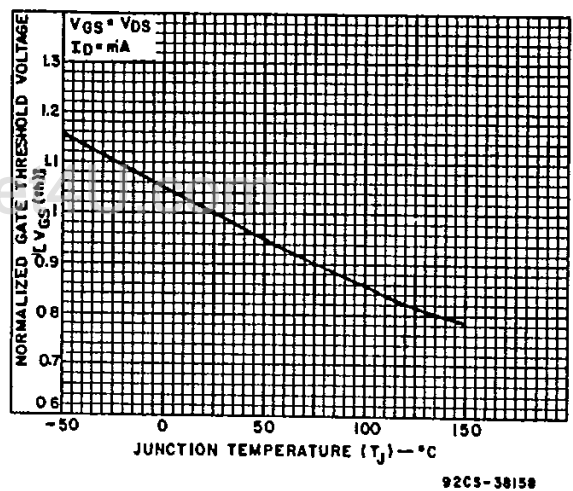

Fig. 3 - Typical normalized gate threshold voltage as a function of junction temperature for all types.

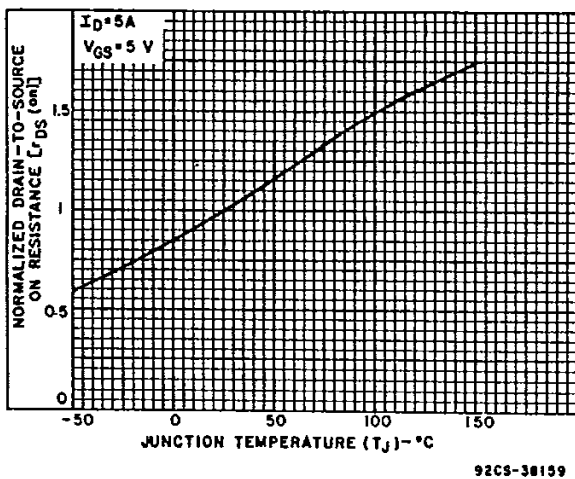

Fig. 4 - Normalized drain-to-source on resistance vs. junction temperature for all types.

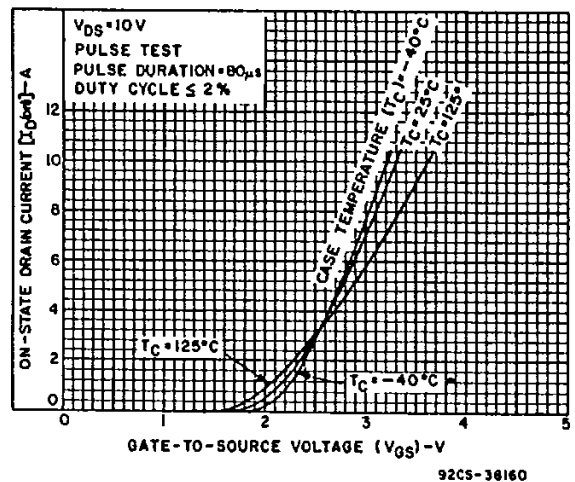

Fig. 5 - Typical transfer characteristics for all types.

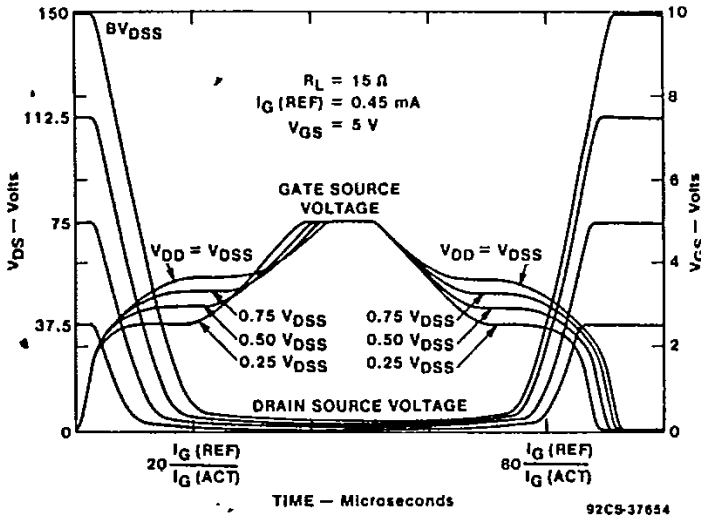

Fig. 6 - Normalized switching waveforms for constant gate-current drive. Refer to RCA Power MOSFETs PMP411A.

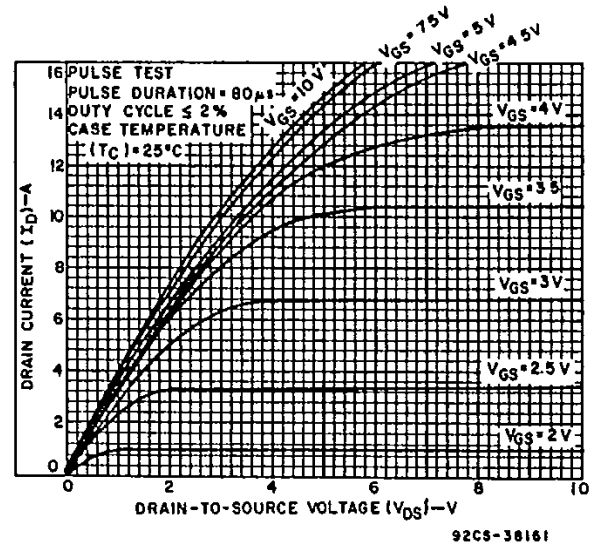

Fig. 7 - Typical saturation characteristics for all types.

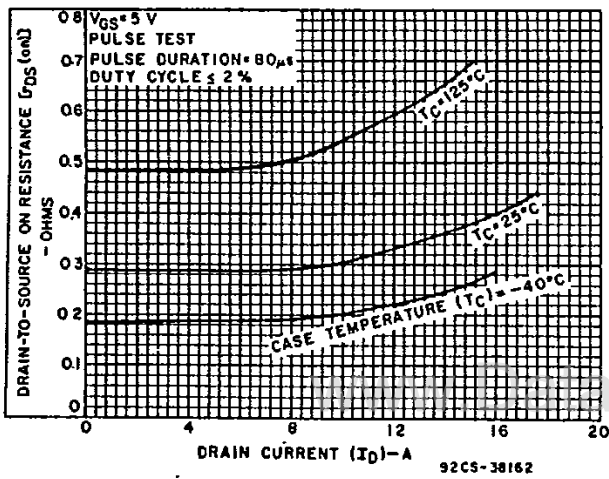

Fig. 8 - Typical drain-to-source on resistance as a function of drain current for all types.

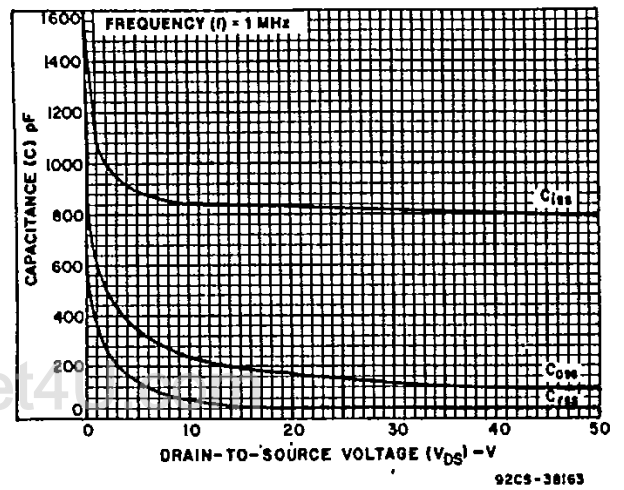

Fig. 9 - Capacitance as a function of drain-to-source voltage for all types.

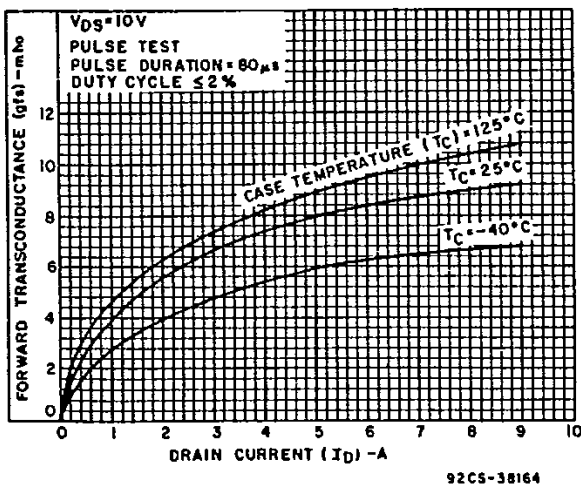

Fig. 10 - Typical forward transconductance as a function of drain current for all types.

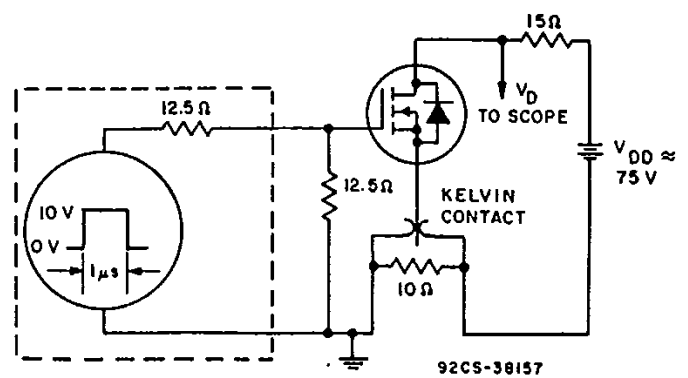
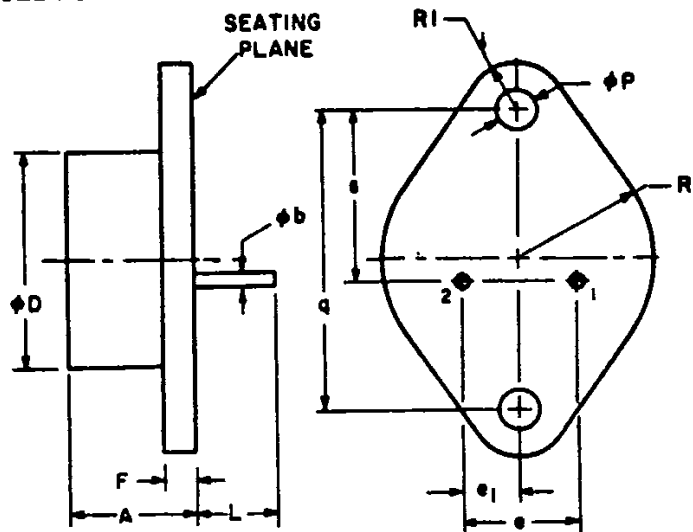

Fig. 11 - Switching Time Test Circuit.

Dimensional Outlines

JEDEC TO-204AA



SYMBOL	INCHES		MILLIMETERS		NOTE
	MIN.	MAX.	MIN.	MAX.	
A	0.250	0.450	6.4	11.4	
ϕb	0.038	0.043	0.968	1.092	
ϕD	—	0.875	—	22.22	
e	0.420	0.440	10.67	11.17	
e_1	0.205	0.225	5.21	5.71	
F	—	0.135	—	3.42	
L	0.312	—	7.93	—	
ϕP	0.151	0.161	3.84	4.08	
q	1.187 BSC		30.15 BSC		
R	—	0.525	—	13.33	
R_1	—	0.188	—	4.77	
s	0.655	0.675	16.64	17.14	

92CS-37249R1

JEDEC TO-204AE

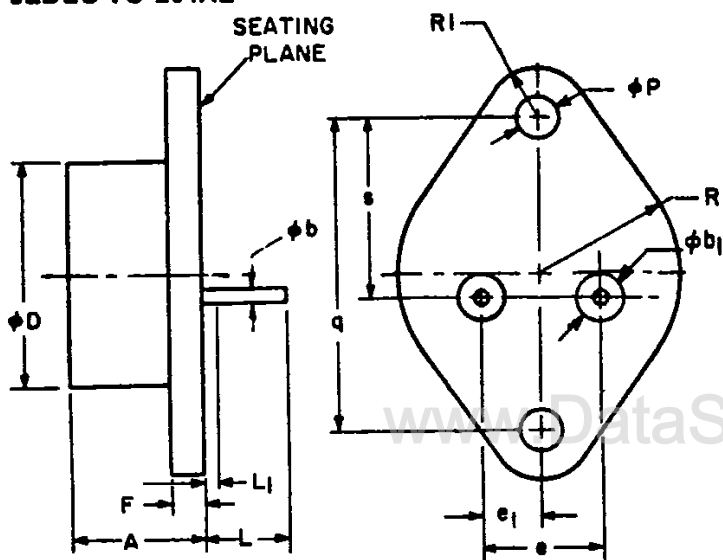

SYMBOL	INCHES		MILLIMETERS		NOTES
	MIN.	MAX.	MIN.	MAX.	
A	0.250	0.450	6.4	11.4	
ϕb	0.057	0.063	1.45	1.60	
ϕb_1	0.141 NOM		3.58 NOM		
ϕD_2	—	0.875	—	22.22	
e	0.420	0.440	10.67	11.17	
e_1	0.205	0.225	5.21	5.71	
F	0.060	0.135	1.53	3.42	
L	0.440	0.480	11.18	12.19	
ϕP	0.151	0.161	3.84	4.08	
q	1.187 BSC		30.15 BSC		
R	0.495	0.525	12.58	13.33	
R_1	0.131	0.188	3.33	4.77	
s	0.655	0.675	16.64	17.14	

92CS-37523

JEDEC TO-205AF

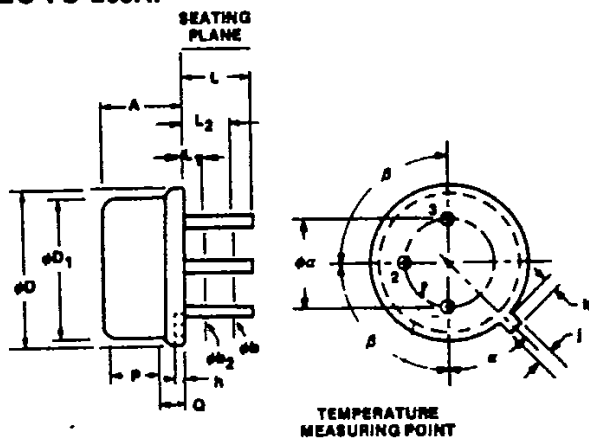

Notes:

1. Dimension k measured from ϕD maximum.
2. ϕD_1 shall not vary more than 0.010 in Zone P. This zone controlled for automatic handling.
3. Details of outline in this zone optional.
4. Leads at gauge plane 0.054-0.055 below seating plane shall be within 0.007 radius of positional tolerance at MMC relative to tab at MMC. Device may be measured by direct methods or by gauge and gauging procedure described on JEDEC gauge drawing G8-1.
5. ϕb_2 applies between L_1 and L_2 . ϕb applies between L_2 and L minimum. Diameter is uncontrolled in L_1 and beyond L minimum.

SYMBOL	INCHES		MILLIMETERS		NOTES
	MIN.	MAX.	MIN.	MAX.	
ϕa	0.200 BSC		5.08 BSC		4
A	0.160	0.180	4.07	4.57	
ϕb	0.016	0.021	0.41	0.53	5
ϕb_2	0.016	0.019	0.41	0.48	5
ϕD	0.340	0.370	8.64	9.39	
ϕD_1	0.315	0.355	8.01	9.01	2
h	0.009	0.041	0.23	1.04	
j	0.028	0.034	0.72	0.86	
k	0.029	0.045	0.74	1.14	1
L	0.500	0.750	12.70	19.05	5
L_1	—	0.050	—	1.27	5
L_2	0.250	—	6.35	—	5
P	0.070	—	1.78	—	2
Q	—	0.050	—	1.27	3
α	45° NOMINAL				
β	90° NOMINAL				

92CS-38248R1

Dimensional Outlines

JEDEC TO-220AC

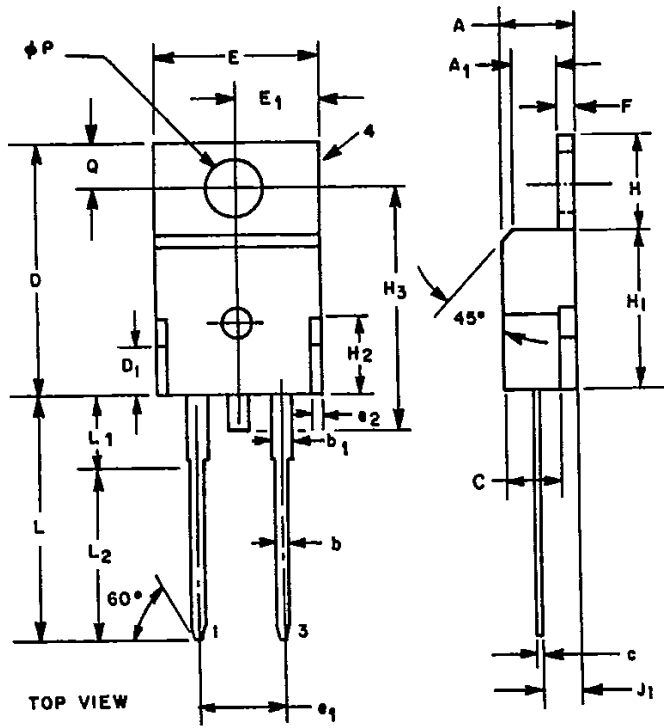

NOTES:

1. Position of lead to be measured 0.250-0.255 in. (6.350-6.477 mm) from case.

SYMBOL	INCHES		MILLIMETERS	
	MIN.	MAX.	MIN.	MAX.
A	0.140	0.190	3.56	4.82
A ₁	0.080	0.085	2.03	2.16
b	0.020	0.045	0.51	1.14
b ₁	0.045	0.070	1.14	1.77
C	—	0.125	—	3.18
c	0.015	0.025	0.38	0.63
D	0.560	0.625	14.23	15.87
D ₁	—	0.100	—	2.54
E	0.380	0.420	9.66	10.66
e ₁	0.190	0.210	4.83	5.33
e ₂	—	0.030	—	0.76
F	0.045	0.055	1.14	1.39
H	0.230	0.270	5.85	6.85
H ₁	0.355	0.370	9.02	9.40
H ₂	—	0.160	—	4.06
H ₃	—	0.600	—	15.24
J ₁	0.080	0.115	2.04	2.92
L	0.500	0.562	12.70	14.27
L ₁	—	0.250	—	6.35
L ₂	0.400	0.410	10.16	10.41
ϕP	0.139	0.161	3.531	4.089
Q	0.100	0.120	2.54	3.04

92CS-34830R1

www.DataSheet4U.com

Mounting Hardware

T-91-20

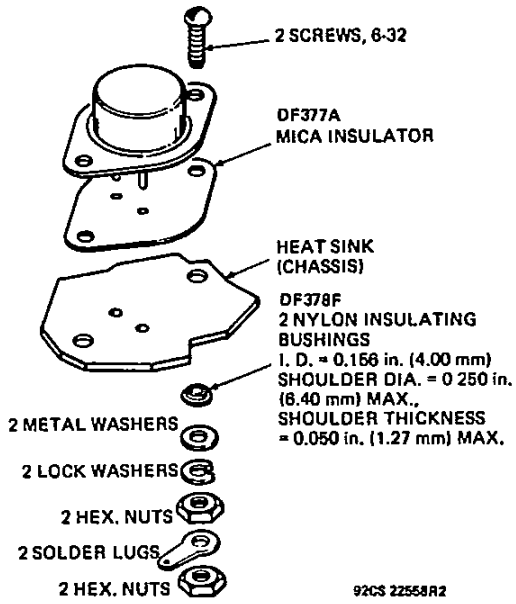

NOTE: MAXIMUM TORQUE APPLIED TO MOUNTING FLANGE IS 12 in.-lbs. (0.14 kgf m)

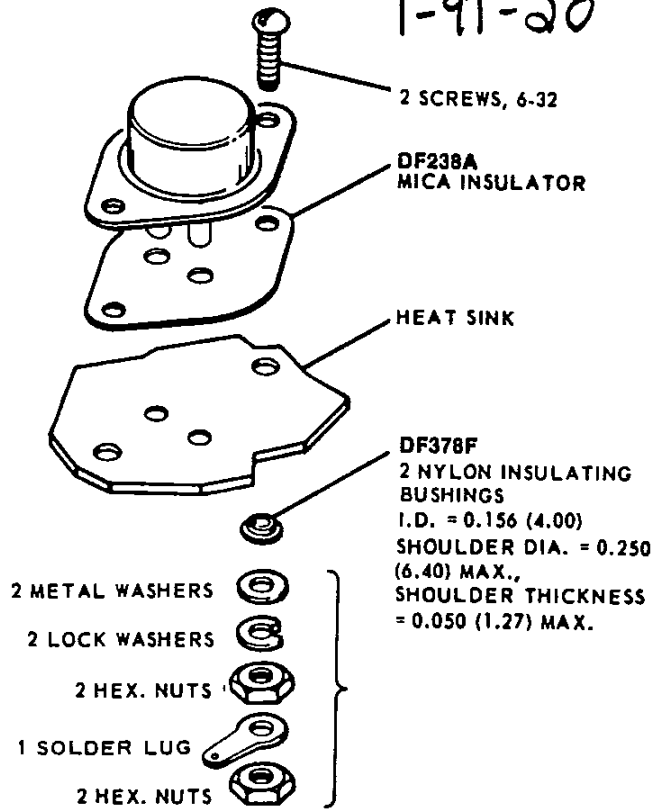

Suggested mounting hardware for JEDEC TO-204AA (formerly JEDEC TO-3)

Suggested mounting hardware for JEDEC TO-204AE (formerly JEDEC TO-3)

www.DataSheet4U.com

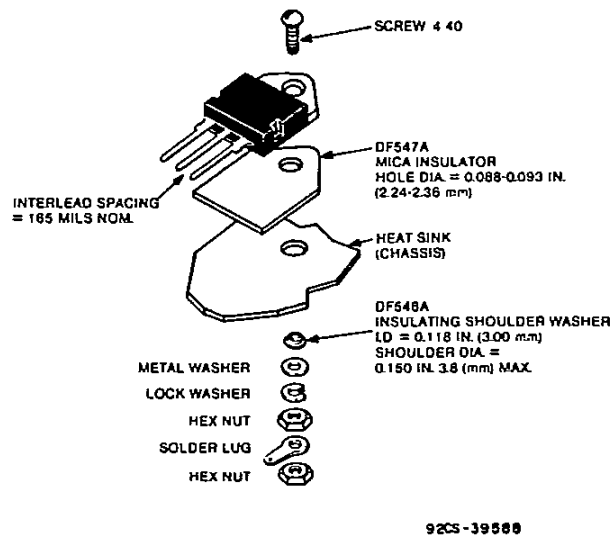

Suggested mounting hardware for JEDEC TO-218AC

Mounting Hardware

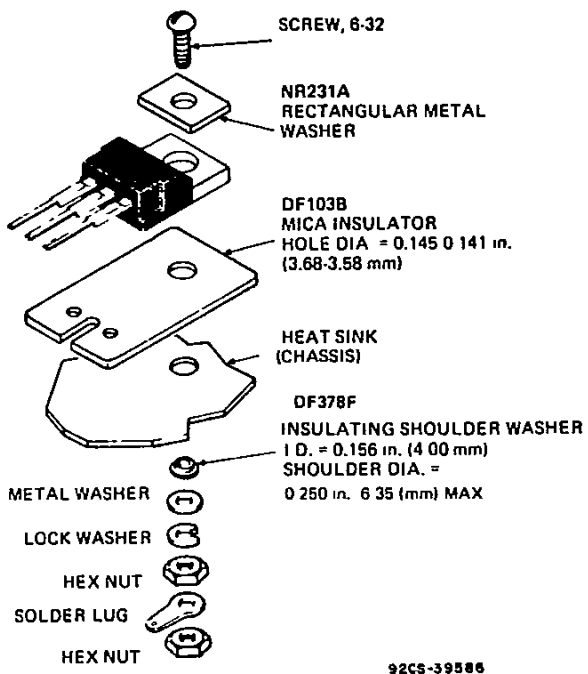

NOTE: MAXIMUM TORQUE APPLIED TO MOUNTING FLANGE IS 8 in. lb. (0.09 kgf m)

Suggested mounting hardware for JEDEC TO-220AB

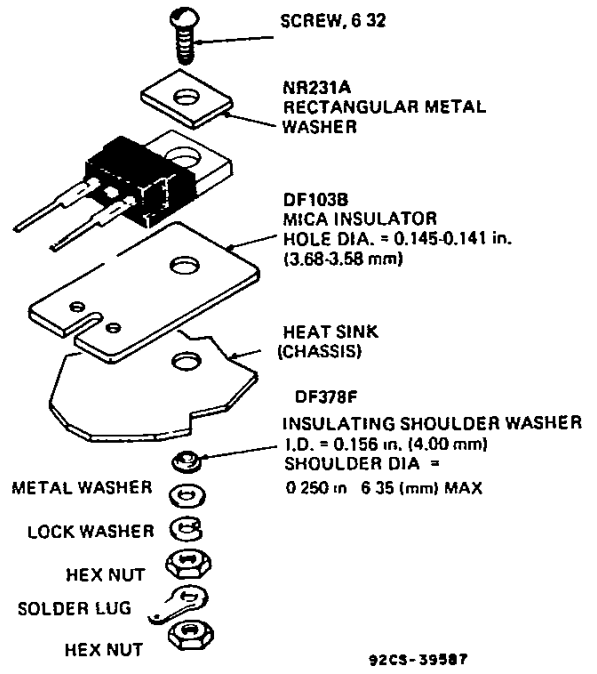

NOTE: MAXIMUM TORQUE APPLIED TO MOUNTING FLANGE IS 8 in. lb. (0.09 kgf m)

Suggested mounting hardware for JEDEC TO-220AC