

RFPA1545

4W P1dB, 5V Linear Power Amplifier
150MHz to 1000MHz

The RFPA1545 is a single-stage GaAs HBT power amplifier specifically designed for high power, high efficiency applications. It is also well-suited for Wireless infrastructure linear driver amplifier applications. The RFPA1545 can be optimized for either linear or saturated operation over sub-bands within 150MHz to 1000MHz. It also offers low noise figure making it an excellent solution for 2nd and 3rd stage LNAs. The RFPA1545 exhibits excellent thermal performance through the use of a thermally-enhanced plastic surface-mount slug package.

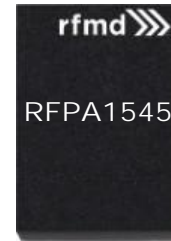

Package: DFN, 12-pin,
4.0mm x 5.0mm

Features

- Flexible Bias for DPD, APD or Uncorrected Linear Applications
- Uncorrected WCDMA Pout at 25.5dBm, 48dBc ACPR, PAR 10dB at 5V
- Gain = 17dB at 945MHz
- Externally Matched for Band Selection
- V_{CC} = 3V to 7V
- No Power Supply Sequencing
- No Negative Supply Voltage

Applications

- Small Cell Base Station, Picocell, Output Power Amplification
- Driver Amplifier for Commercial Wireless Infrastructure
- General Purpose Power Amplifier

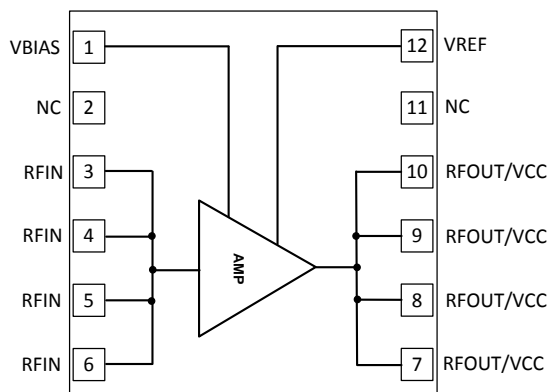

Functional Block Diagram

Ordering Information

RFPA1545SQ	Sample bag with 25 pieces
RFPA1545SR	7" Reel with 100 pieces
RFPA1545TR13	13" Reel with 2500 pieces
RFPA1545PCK-410	450MHz to 470MHz PCBA with 5-piece sample bag
RFPA1545PCK-411	728MHz to 768MHz PCBA with 5-piece sample bag
RFPA1545PCK-412	920MHz to 960MHz PCBA with 5-piece sample bag

Absolute Maximum Ratings

Parameter	Rating	Unit
Supply Voltage (V_{CC} and V_{BIAS})	8.5	V
Device Current	2800	mA
V_{REF} Device Current	10	mA
V_{REF} Device Voltage	3.5	V
CW Input Power, 50 Ω Load, 460MHz, 748MHz and 940MHz Bands	30	dBm
Modulated (WCDMA) Input Power, 6:1 Output VSWR, 460MHz Band	23	dBm
Modulated (WCDMA) Input Power, 6:1 Output VSWR, 748MHz and 940MHz Bands	27	dBm
Storage Temperature	-40 to +150	$^{\circ}$ C
ESD Rating – Human Body Model (HBM)	Class 2	
Moisture Sensitivity Level	MSL2	



Caution! ESD sensitive device.



RFMD Green: RoHS status based on EU Directive 2011/65/EU (at time of this document revision), halogen free per IEC 61249-2-21, < 1000ppm each of antimony trioxide in polymeric materials and red phosphorus as a flame retardant, and <2% antimony in solder.

Exceeding any one or a combination of the Absolute Maximum Rating conditions may cause permanent damage to the device. Extended application of Absolute Maximum Rating conditions to the device may reduce device reliability. Specified typical performance or functional operation of the device under Absolute Maximum Rating conditions is not implied.

Notes:

1. The maximum ratings must all be met simultaneously.
2. $P_{DISS} = P_{DC} + P_{RFIN} + P_{RFOUT}$
3. $T_J = T_L + P_{DISS} \cdot R_{TH}$

Recommended Operating Condition

Parameter	Specification			Unit
	Min	Typ	Max	
Operating Temperature Range	-40		+105	$^{\circ}$ C
Operating Junction Temperature ¹			160	$^{\circ}$ C
Collector Voltage		5	5.5	V

Note 1: MTTF 1E6 Hours

Nominal Operating Parameters

Parameter	Specification			Unit	Condition
	Min	Typ	Max		
450MHz to 470MHz Band					$V_{CC} = V_{BIAS} = V_{REG} = 5V$, Temp = 25$^{\circ}$C, Optimized for ACPR At Rated Power
Frequency		460		MHz	
Gain		19.5		dB	
Output IP3		49		dBm	P_{OUT} 20dBm per tone, 1MHz spacing
ACPR		-48.5		dBc	RF Output Power = 25.5dBm, WCDMA 3GPP 3.5, test model 1, 64 DPCH
Output P1dB		35		dBm	
Input Return Loss		14		dB	
Output Return Loss		7		dB	
Noise Figure		5		dB	
Input Power (P_{IN})		30		dBm	Max recommended continuous P_{IN} , $V_{CC} = V_{BIAS} = 5V$, Load VSWR = 2:1

Parameter	Specification			Unit	Condition
	Min	Typ	Max		
728MHz to 768MHz Band					$V_{CC} = V_{BIAS} = V_{REG} = 5V$, Temp = 25°C, Optimized for ACPR At Rated Power
Frequency		750		MHz	
Gain		17		dB	
Output IP3		49		dBm	P_{OUT} 20dBm per tone, 1MHz spacing
ACPR		-47.5		dBc	RF Output Power = 25.5dBm, WCDMA 3GPP 3.5, test model 1, 64 DPCH
P1dB		34.4		dBm	
Input Return Loss		12		dB	Small signal S11
Output Return Loss		8		dB	Small signal S22
Noise Figure		4.4		dB	
Input Power (P_{IN})		30		dBm	Max recommended continuous P_{IN} , $V_{CC} = V_{BIAS} = 5V$, Load VSWR = 2:1
920MHz to 960MHz Band					$V_{CC} = V_{BIAS} = V_{REG} = 5V$, Temp = 25°C, Optimized for ACPR At Rated Power
Frequency		945		MHz	
Gain		17		dB	
Output IP3		47		dBm	P_{OUT} 20dBm per tone, 1MHz spacing
ACPR		-49.5		dBc	RF Output Power = 25.5dBm, WCDMA 3GPP 3.5, test model 1, 64 DPCH
P1dB		34.5		dBm	
Input Return Loss		15		dB	Small signal S11
Output Return Loss		10		dB	Small signal S22
Noise Figure		5		dB	
Input Power (P_{IN})		30		dBm	Max recommended continuous P_{IN} , $V_{CC} = V_{BIAS} = 5V$, Load VSWR = 2:1
Power Supply					
Operating Current (Quiescent)		650		mA	At $V_{CC} = V_{BIAS} = 5V$, $V_{REG} = 5V$
Thermal Resistance		9.5		°C/W	Junction-to-backside of IC, at $V_{CC} = V_{BIAS} = V_{REG} = 5V$, reference temp = 85°C, no RF
Shutdown Leakage Current		10		µA	At $V_{CC} = V_{BIAS} = 5V$, $V_{REG} = 0V$

Typical Application Schematic 400MHz to 1000MHz Application Circuit

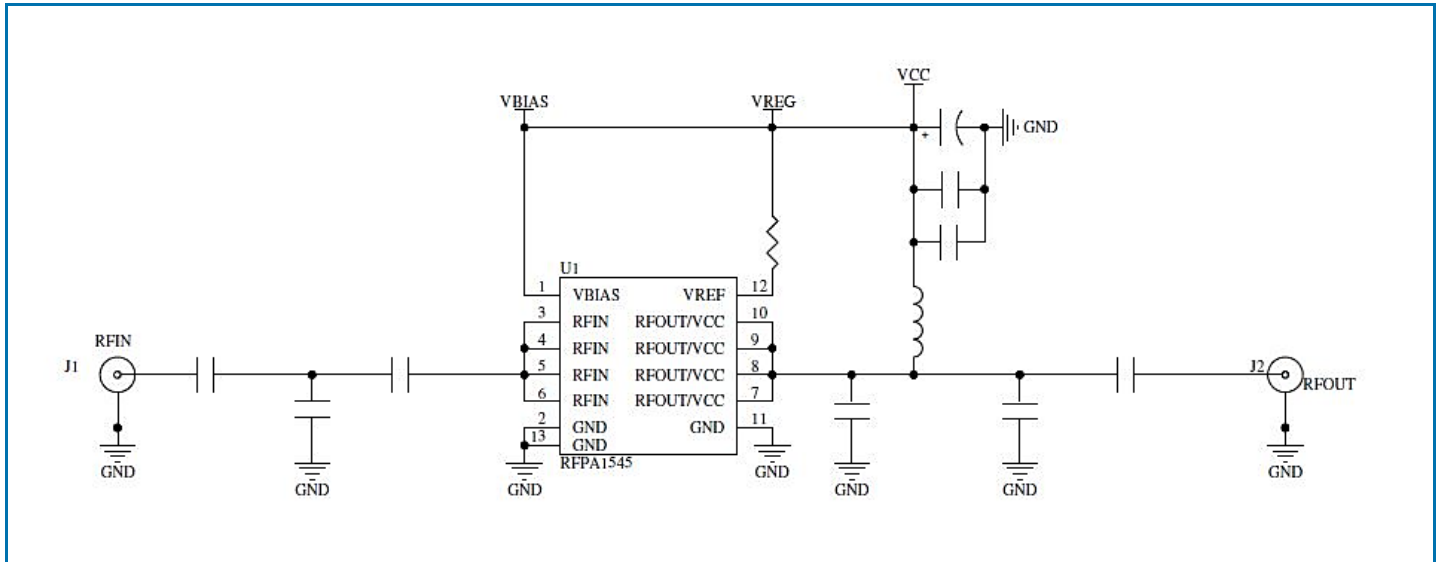

Typical Performance: 460MHz, T=25°C, V_{DD} = 5V unless otherwise noted

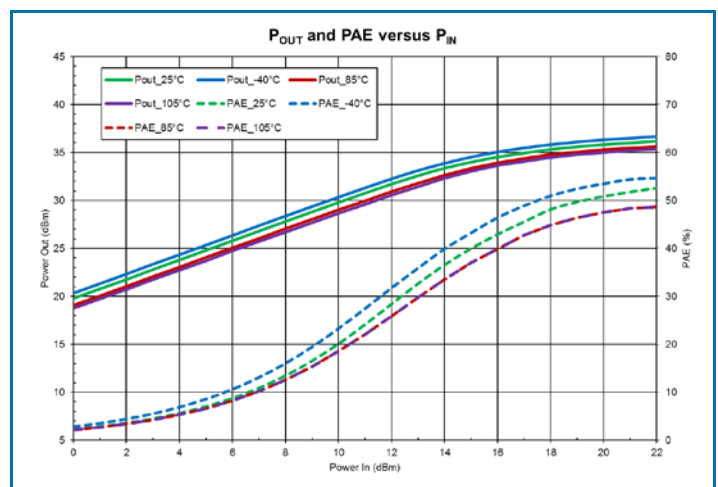
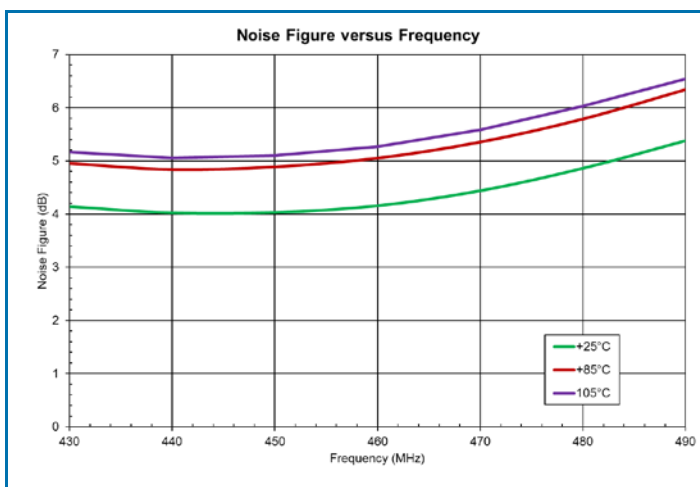
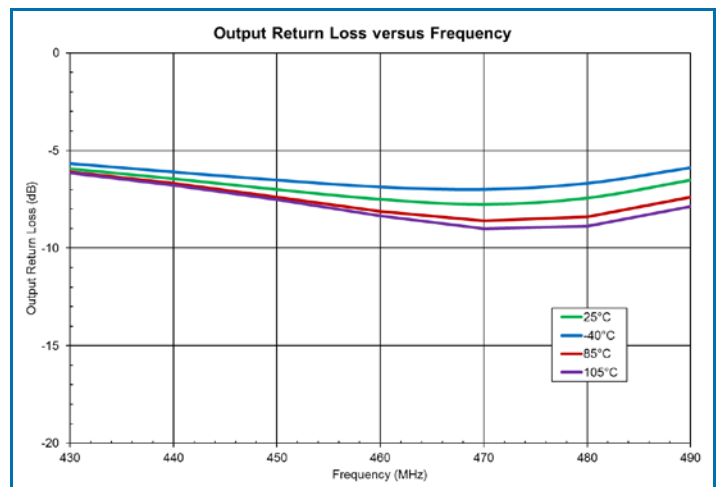
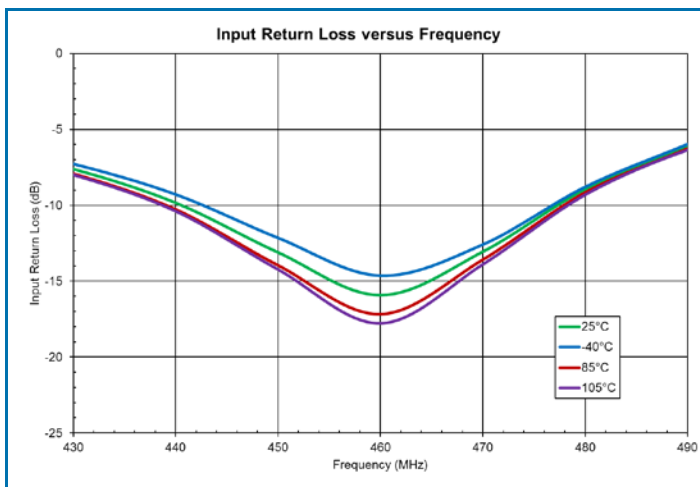
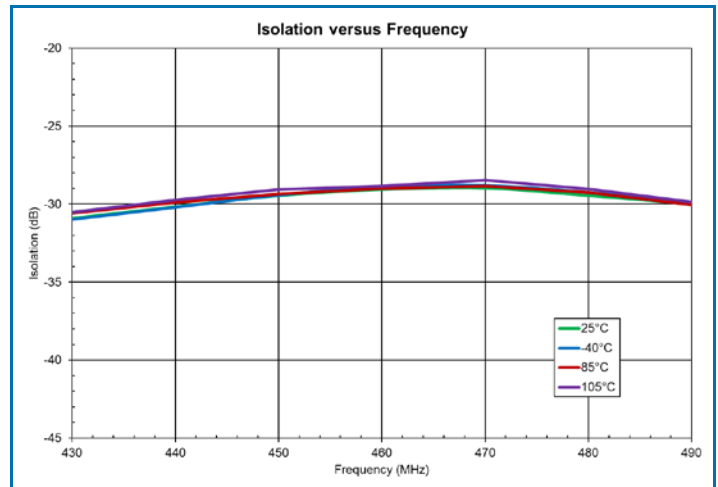
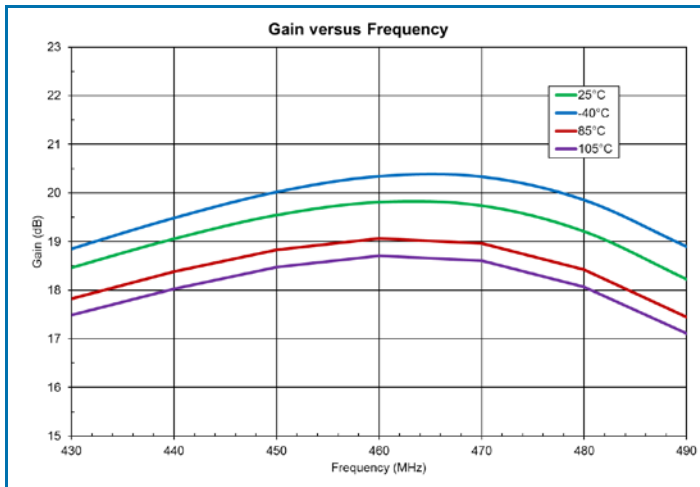

Typical Performance: 460MHz, T=25°C, V_{DD} = 5V unless otherwise noted

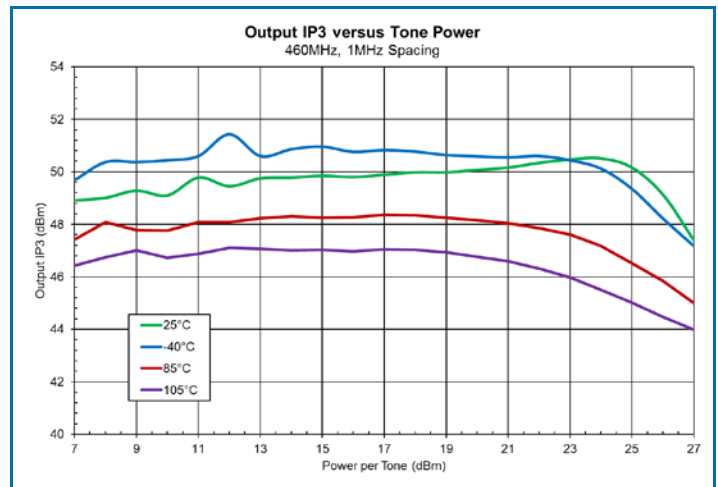
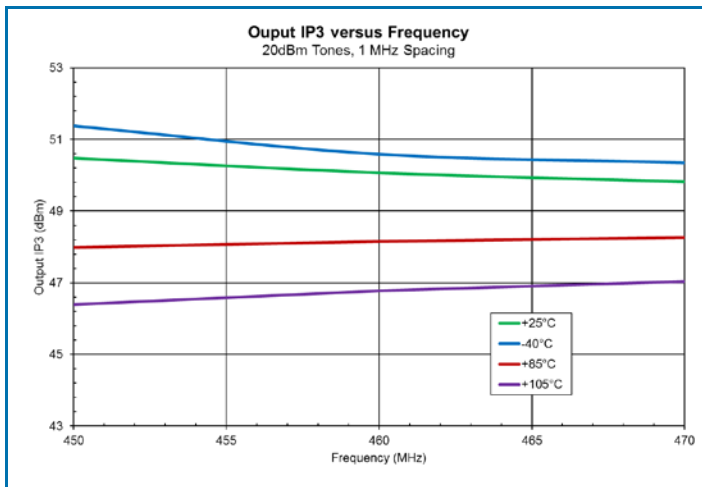
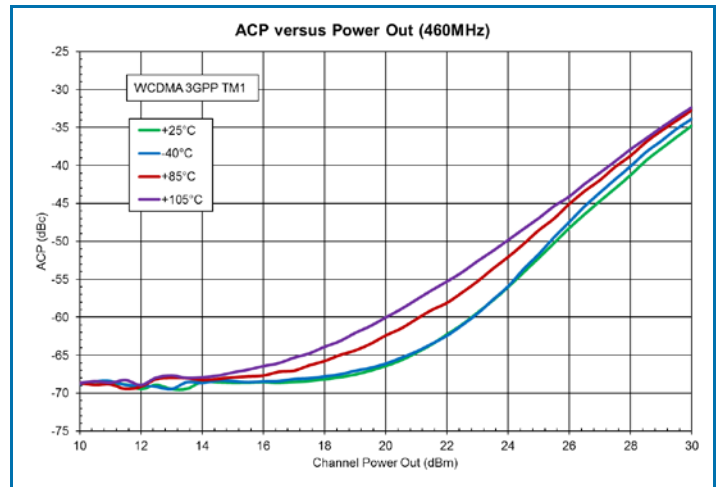
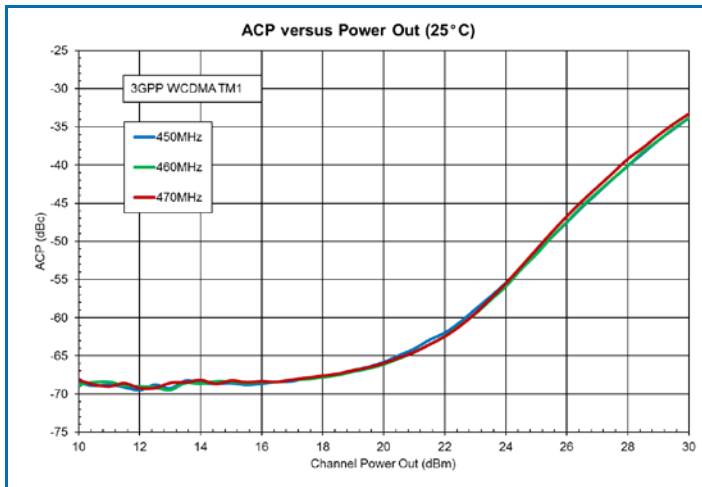

Evaluation Board Schematic 450MHz to 470MHz Application Circuit

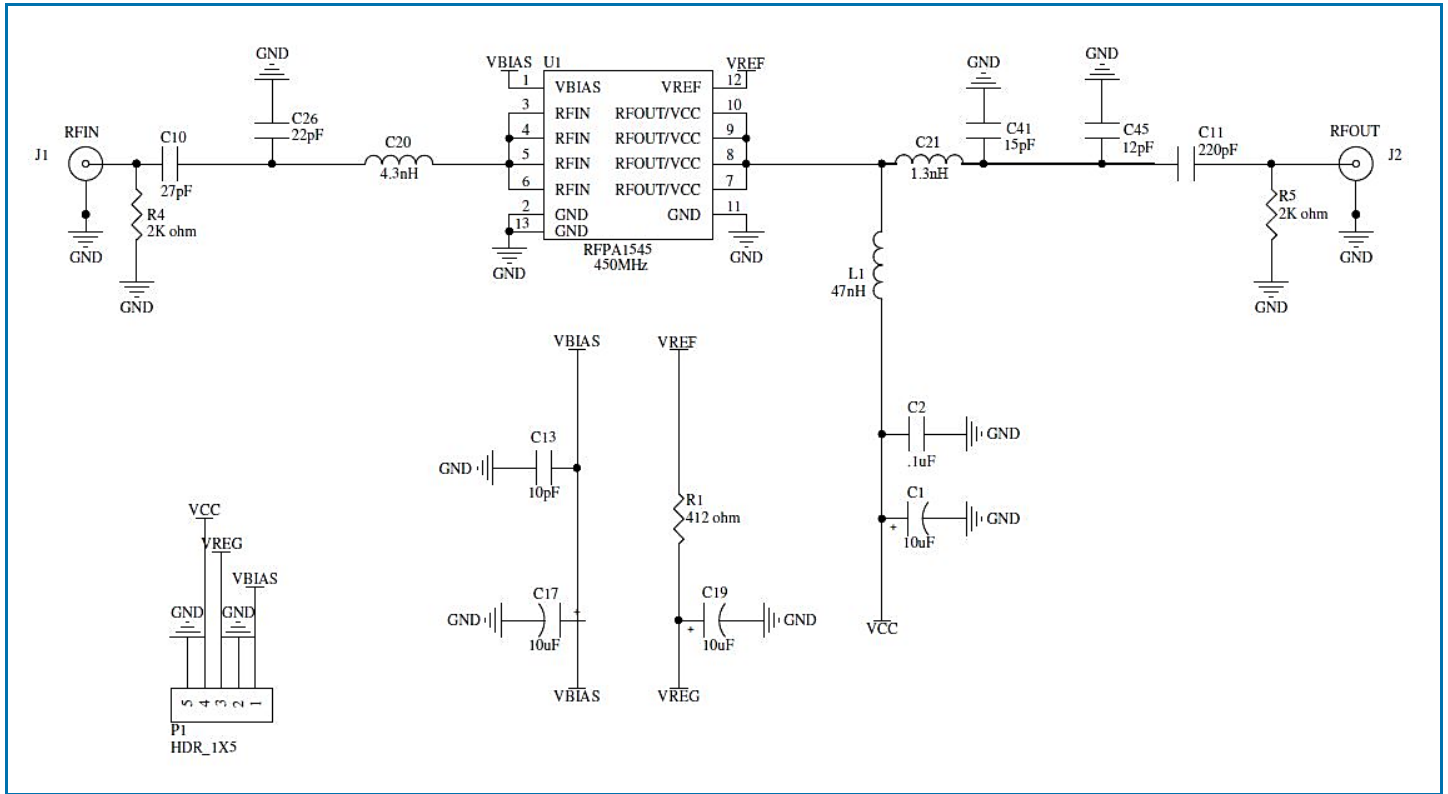

Evaluation Board Bill of Materials (BOM) 450MHz to 470MHz Application Circuit

Description	Reference Designator	Manufacturer	Manufacturer's P/N
RFPA1545	U1	RFMD	RFPA1545
PCB	NA	DDI	PA1545-410(A)
RES, 412Ω, 5%, 1/16W, 0402	R1	Panasonic	ERJ-2RKF4120X
CAP, 0.1μF, 10%, 10V, X5R, 0402	C2	Murata Electronics	GRM155R61A104KA01E
CAP, 10μF, +80% / -20%, 10V, Y5V, 1206	C1, C17, C19	Murata Electronics	GRM31MF51A106ZA01L
CAP, 10pF, 5%, 50V, C0G, 0402	C13	Murata Electronics	GRM1555C1H100JA01D
CAP, 22pF, 5%, 50V, C0G, 0402	C26	Murata Electronics	GRM1555C1H220JA01D
CAP, 12pF, 5%, 50V, HI-Q, 0402	C45	Murata Electronics	GJM1555C1H120JB01E
CAP, 15pF, 5%, 50V, HI-Q, 0402	C41	Murata Electronics	GJM1555C1H150JB01D
CAP, 27pF, 5%, 50V, C0G, 0402	C10	Murata Electronics	GRM1555C1H270JA01D
CAP, 220pF, 10%, 50V, X7R, 0402	C11, C4	Murata Electronics	GRM155R71H221KA01E
CAP, 1000pF, 10%, 50V, X7R, 0402	C3	Murata Electronics	GRM155R71H102KA01E
IND, 4.3nH, +/-0.1nH, T/F, 0402	C20	Murata Electronics	LQP15MN4N3B02D
IND, 1.5nH, +/-0.1nH, W/W, 0402	C21	Murata Electronics	LQW15AN1N5B00D
RES, 2K, 5%, 1/16W, 0402	R4-R5	Kamaya	RMC1/16S-202JTH
IND, 47nH, 5%, W/W, 0603	L1	Coilcraft	0603HC-47NXJLW
CONN, HOUSING, 5 POS, 0.100 HI PRESS	P1	Molex	10/11/2053
CONN, SMA, ST JACK REC, FLNG MT, T/H	J1-J2	Johnson Co.	142-0721-631

Typical Performance: 750MHz, T=25°C, V_{DD} = 5V unless otherwise noted

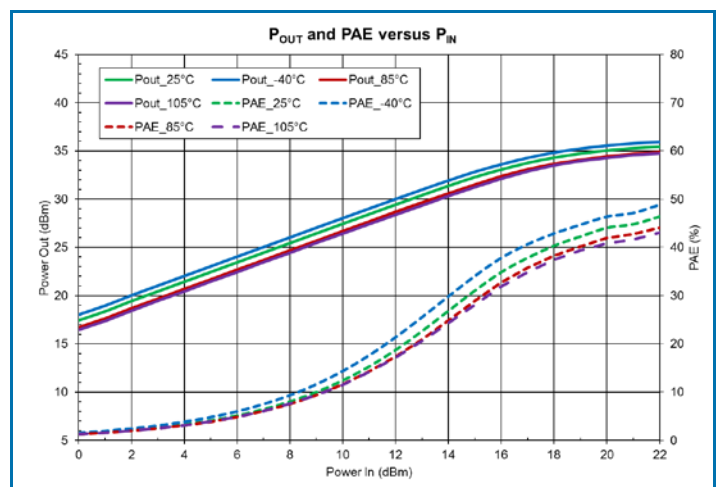
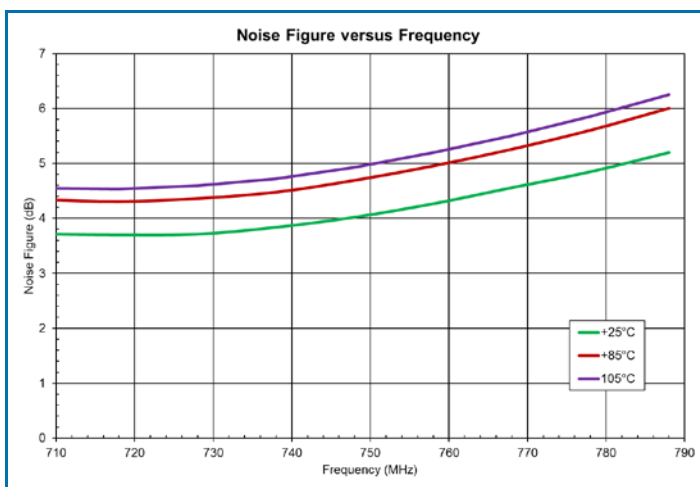
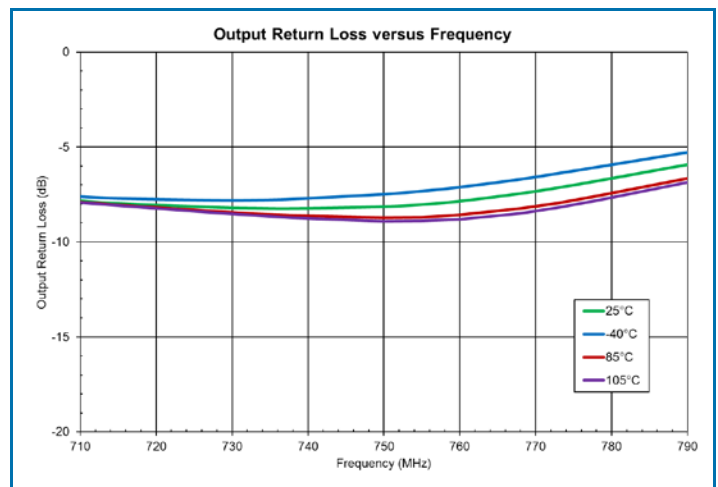
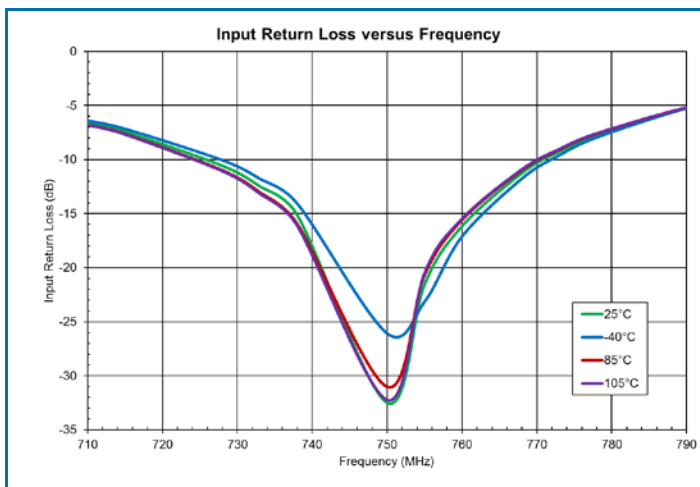
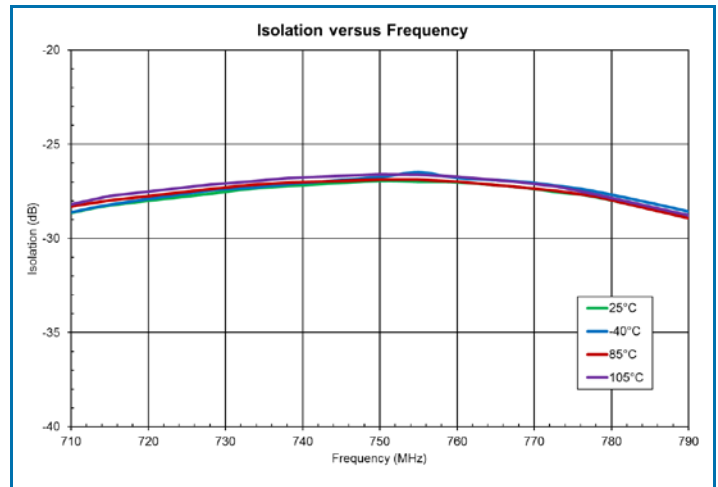
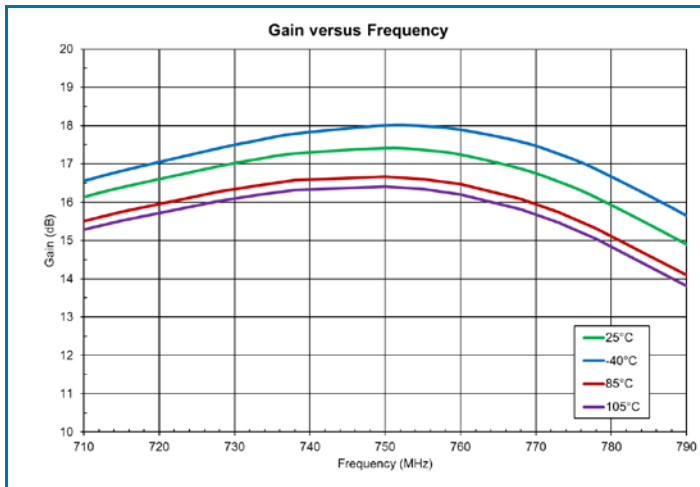

Typical Performance: 750MHz, T=25°C, V_{DD} = 5V unless otherwise noted

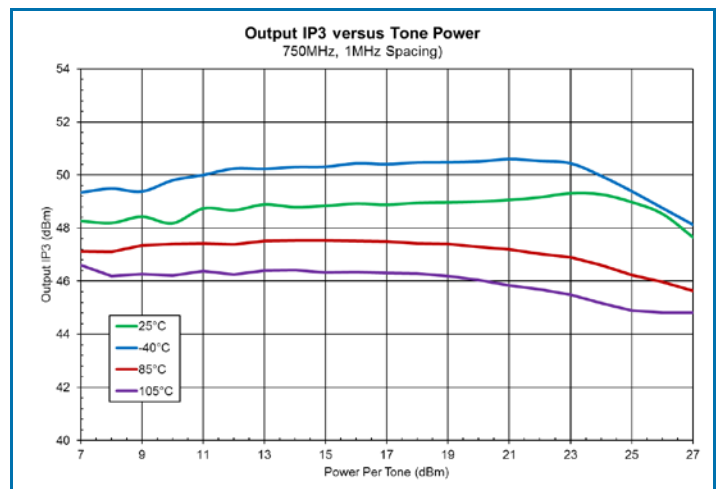
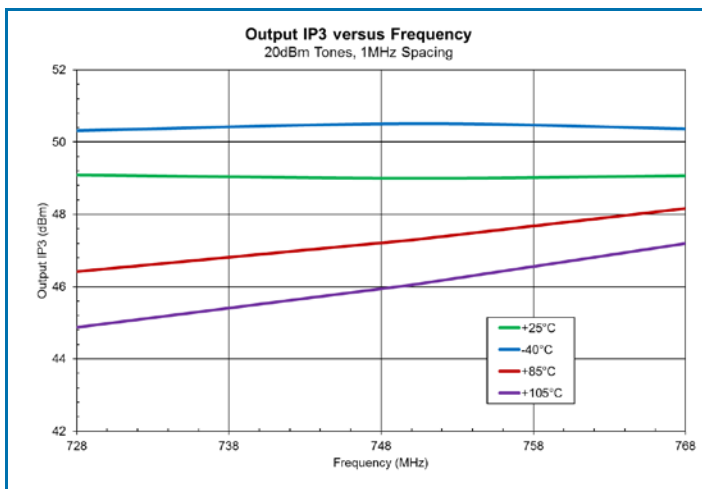
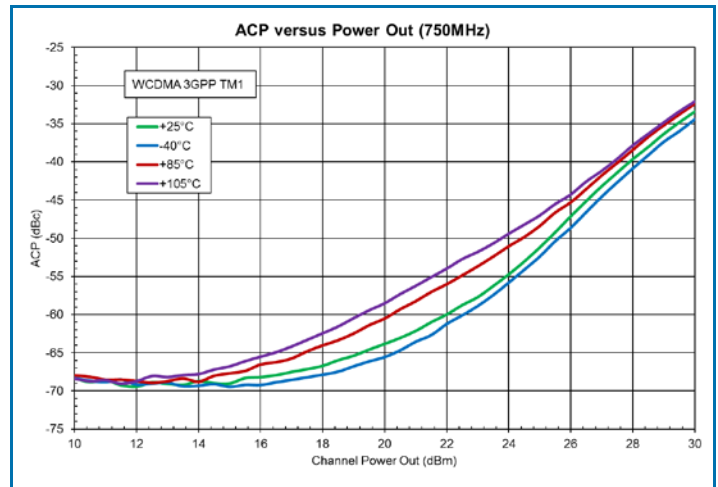
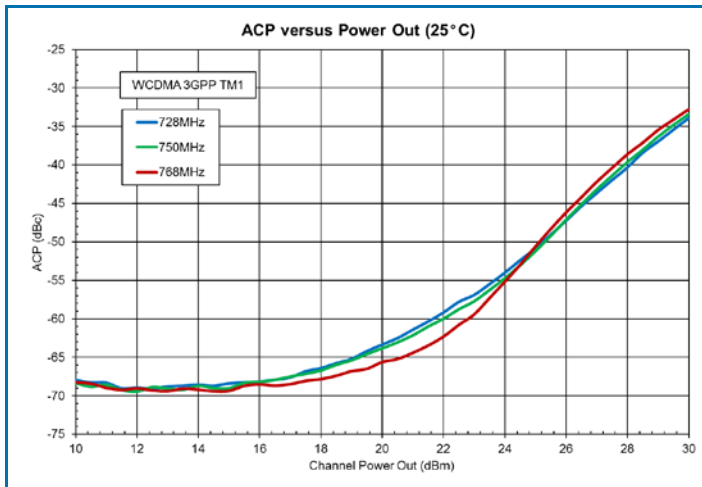

Evaluation Board Schematic 728MHz to 768MHz Application Circuit

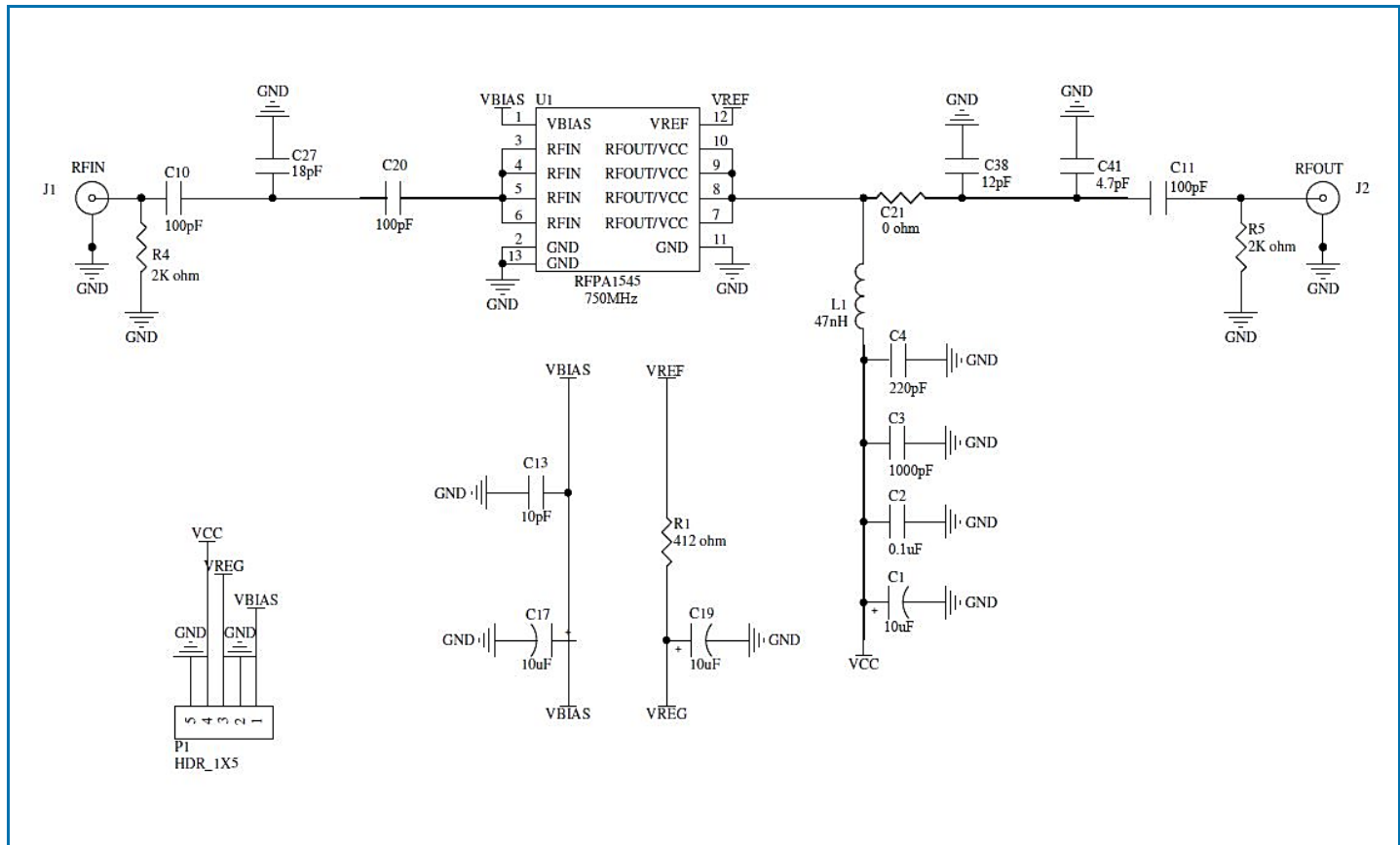

Evaluation Board Bill of Materials (BOM) 728MHz to 768MHz Application Circuit

Description	Reference Designator	Manufacturer	Manufacturer's P/N
RFPA1545	U1	RFMD	RFPA1545
PCB	NA	DDI	PA1545-410(A)
RES, 412Ω, 5%, 1/16W, 0402	R1	Panasonic	ERJ-2RKF4120X
CAP, 0.1μF, 10%, 10V, X5R, 0402	C2	Murata Electronics	GRM155R61A104KA01E
CAP, 10μF, +80% / -20%, 10V, Y5V, 1206	C1, C17, C19	Murata Electronics	GRM31MF51A106ZA01L
CAP, 10pF, 5%, 50V, C0G, 0402	C18	Murata Electronics	GRM1555C1H100JA01D
CAP, 18pF, 5%, 50V, C0G, 0402	C27	Murata Electronics	GRM1555C1H180JA01D
CAP, 12pF, 5%, 50V, HI-Q, 0402	C38	Murata Electronics	GJM1555C1H120JB01E
CAP, 4.7pF, +/-0.25pF, 50V, HI-Q, 0402	C41	Murata Electronics	GJM1555C1H4R7CB01D
CAP, 100pF, 5%, 50V, C0G, 0402	C10-C11, C20	Murata Electronics	GRM1555C1H101JA01D
CAP, 220pF, 10%, 50V, X7R, 0402	C4	Murata Electronics	GRM155R71H221KA01E
CAP, 1000pF, 10%, 50V, X7R, 0402	C3	Murata Electronics	GRM155R71H102KA01E
RES, 0Ω, 0402 KAMAYA	C21	Kamaya	RMC1/16SJPTH
RES, 2K, 5%, 1/16W, 0402	R4-R5	Kamaya	RMC1/16S-202JTH
IND, 47nH, 5%, W/W, 0603	L1	Coilcraft	0603HC-47NXJLW
CONN, HOUSING, 5 POS, 0.100 HI PRESS	P1	Molex	10/11/2053
CONN, SMA, ST JACK REC, FLNG MT, T/H	J1-J2	Johnson Co.	142-0721-631

Typical Performance: 960MHz, T=25°C, V_{DD} = 5V unless otherwise noted

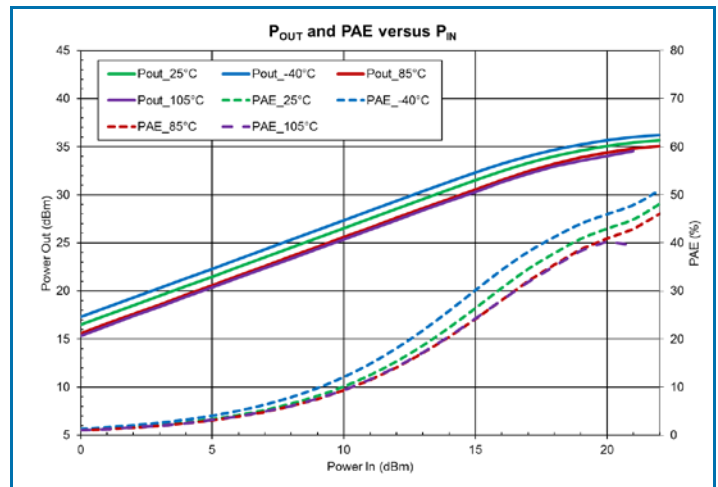
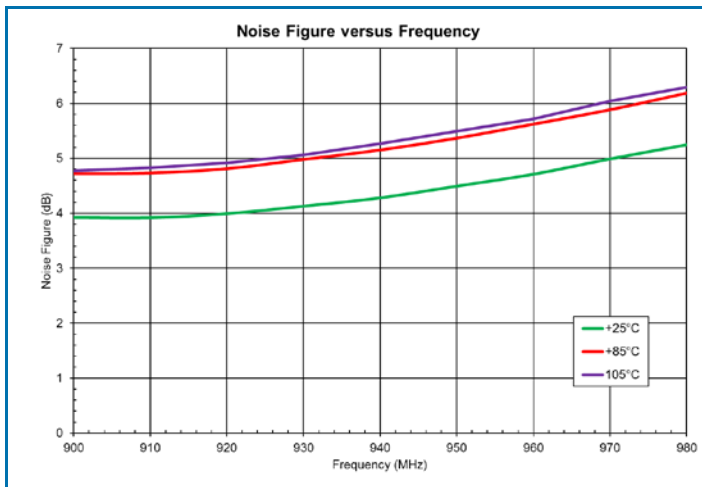
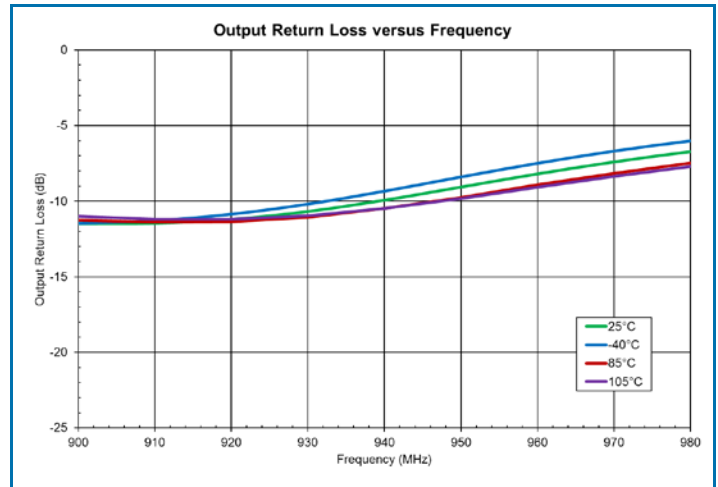
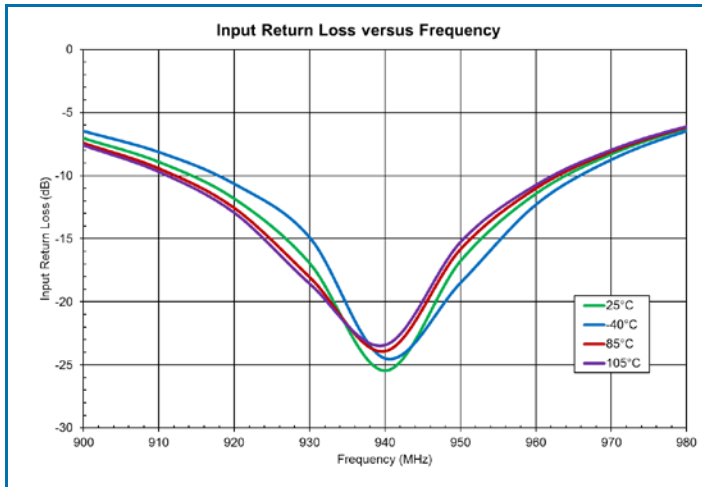
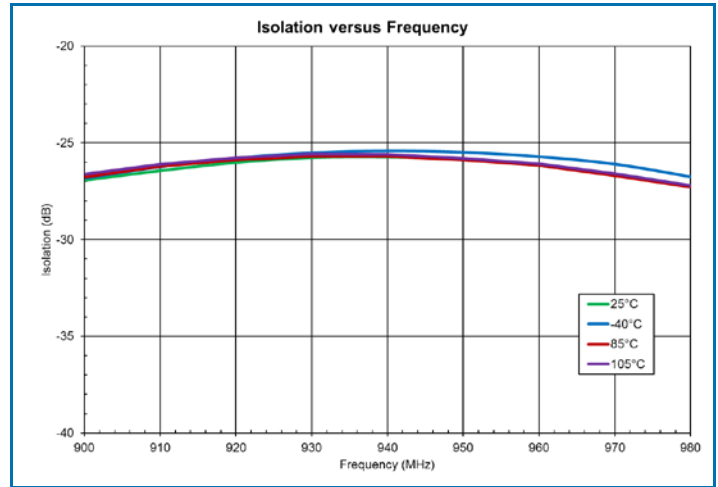
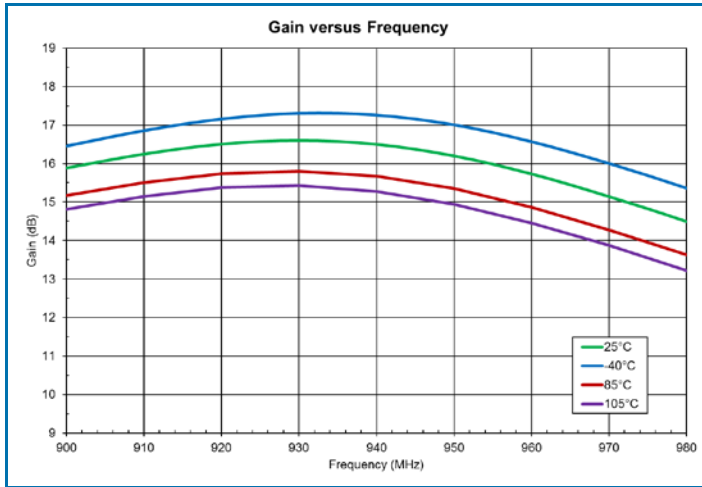

Typical Performance: 960MHz, T=25°C, V_{DD} = 5V unless otherwise noted

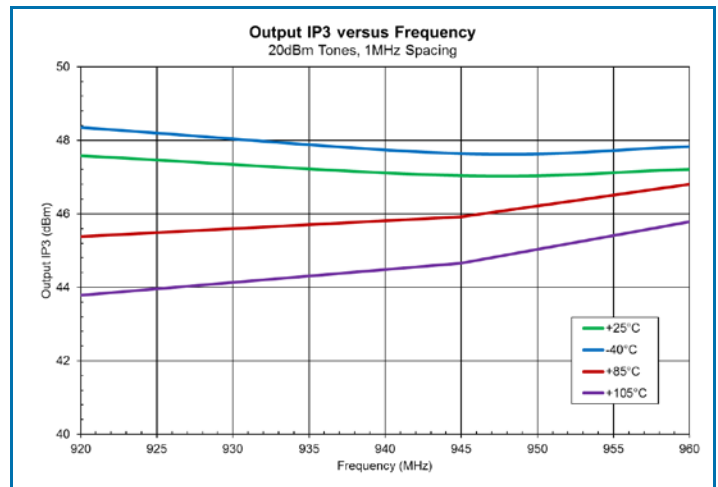
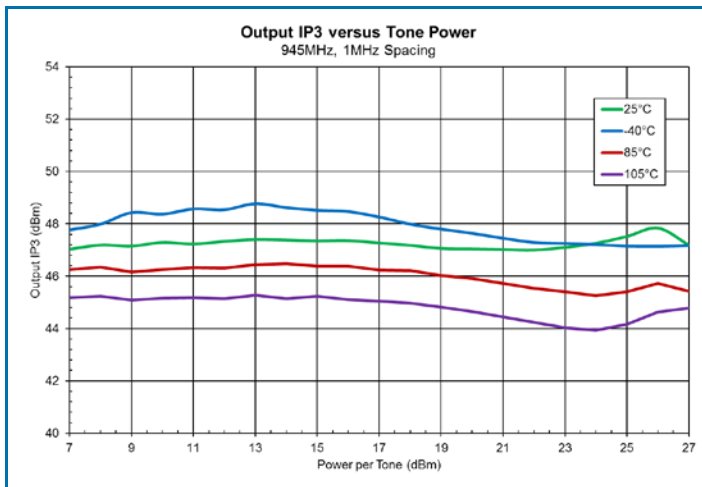
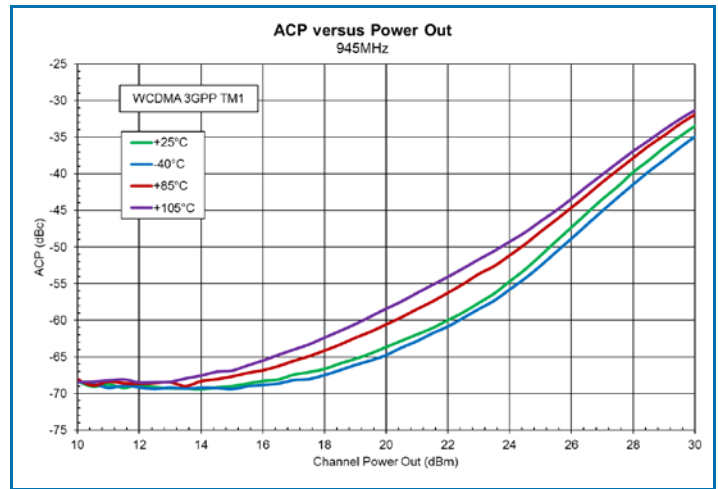
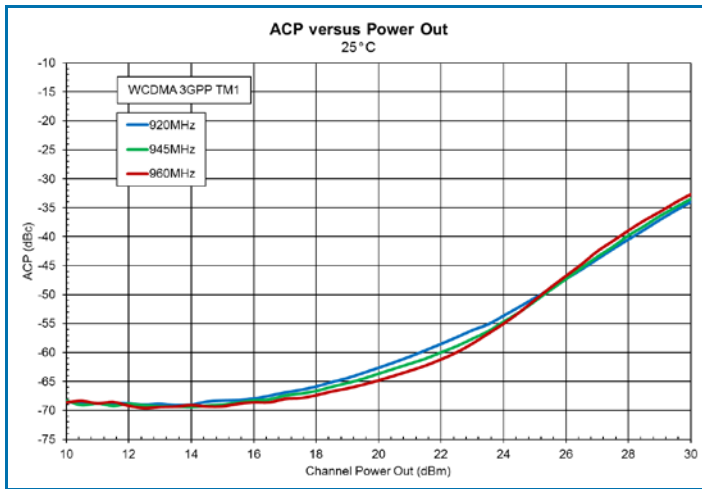

Evaluation Board Schematic 920MHz to 960MHz Application Circuit

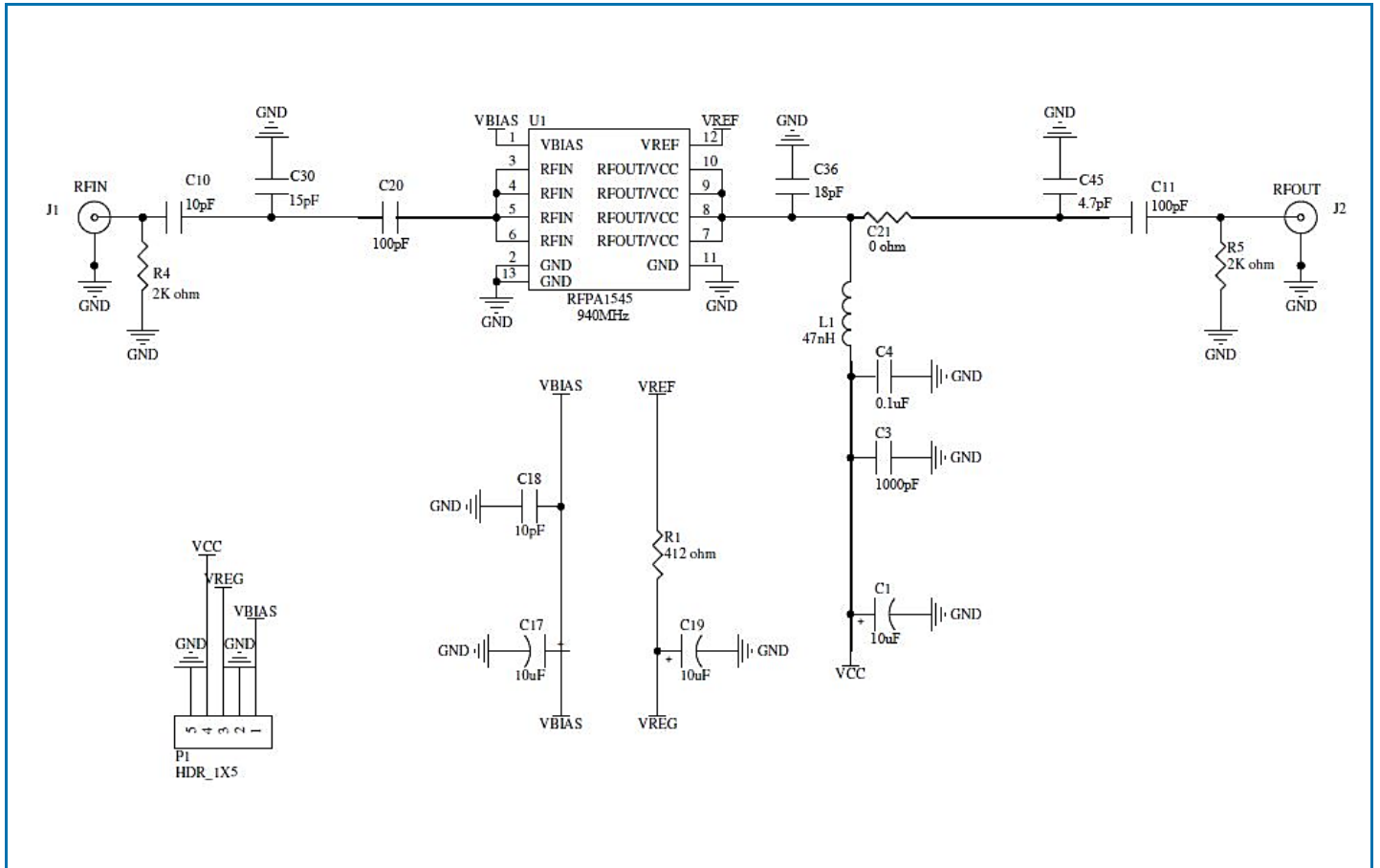

Evaluation Board Bill of Materials (BOM) 920MHz to 960MHz Application Circuit

Description	Reference Designator	Manufacturer	Manufacturer's P/N
RFPA1545	U1	RFMD	RFPA1545
PCB	NA	DDI	PA1545-410(A)
RES, 412Ω, 5%, 1/16W, 0402	R1	Panasonic	ERJ-2RKF4120X
CAP, 0.1μF, 10%, 10V, X5R, 0402	C4	Murata Electronics	GRM155R61A104KA01E
CAP, 10μF, +80% / -20%, 10V, Y5K, 1206	C1, C17	Murata Electronics	GRM31MF51A106ZA01L
CAP, 4.7pF, +/-0.25pF, 50V, HI-Q, 0402	C45	Murata Electronics	GJM1555C1H4R7CB01D
CAP, 15pF, 5%, 50V, C0G, 0402	C30	Murata Electronics	GRM1555C1H150JA01D
CAP, 18pF, 5%, 50V, HI-Q, 0402	C36	Murata Electronics	GJM1555C1H180JB01D
CAP, 10pF, 5%, 50V, C0G, 0402	C10, C18	Murata Electronics	GRM1555C1H100JA01D
CAP, 1000pF, 10%, 50V, X7R, 0402	C3	Murata Electronics	GRM155R71H102KA01E
CAP, 100pF, 5%, 50V, C0G, 0402	C20, C11	Taiyo Yuden (USA), Inc.	RM UMK105 CG101JV-F
RES, 0Ω, 0402 KAMAYA	C21	Kamaya, Inc.	RMC1/16SJPTH
RES, 2K, 5%, 1/16W, 0402	R4-R5	Kamaya, Inc.	RMC1/16S-202JTH
IND, 47nH, 5%, WW, 0603	L1	Coilcraft	0603HC-47NXJLW
CONN, HOUSING, 5 POS, 0.100 HI PRESS	P1	Molex	10/11/2053
CONN, SMA, ST JACK REC, FLNG MT, T/H	J1-J2	Johnson Co.	142-0721-631

Evaluation Board Assembly Drawing:

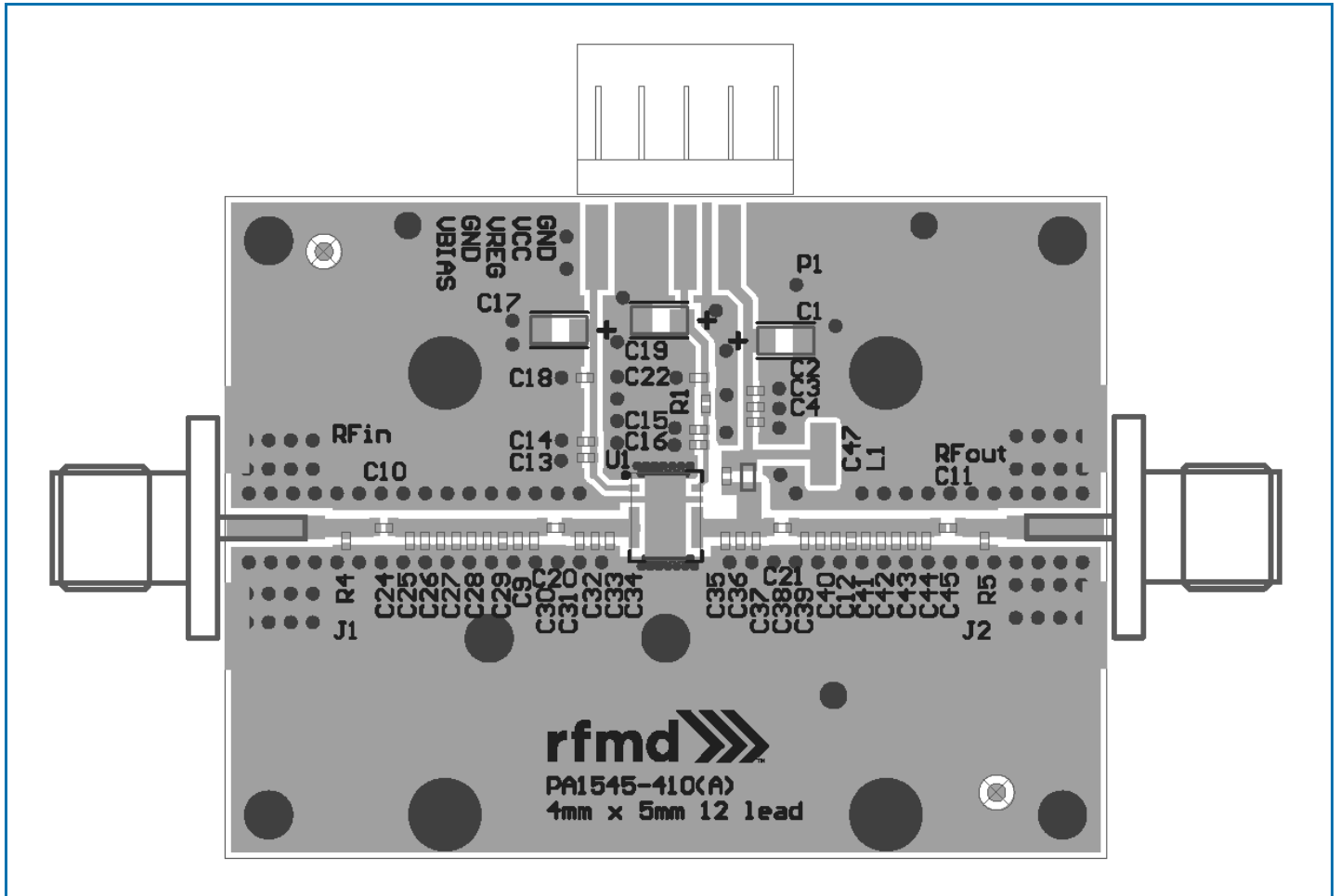

Pin Names and Descriptions

Pin	Name	Description
1	VBIAS	Supply voltage for active bias circuit
2	NC	No internal connection
3	RFIN	RF input; must be DC blocked
4	RFIN	RF input; must be DC blocked
5	RFIN	RF input; must be DC blocked
6	RFIN	RF input; must be DC blocked
7	RFOUT	RF output and collector voltage supply
8	RFOUT	RF output and collector voltage supply
9	RFOUT	RF output and collector voltage supply
10	RFOUT	RF output and collector voltage supply
11	NC	No internal connection
12	VREF	Current Adjust / Shutdown control, pull up to V_{REF} with series resistor, use $V_{REF} > 3.5V$ for optimum current stability versus temperature
EPAD	GND	DC/RF Ground. Must be soldered to EVB Ground Plane over an array of vias for thermal and RF performance. Solder voids under the EPAD will result in excessive junction temperatures causing permanent damage.

Package Outline Drawing (Dimensions in millimeters)

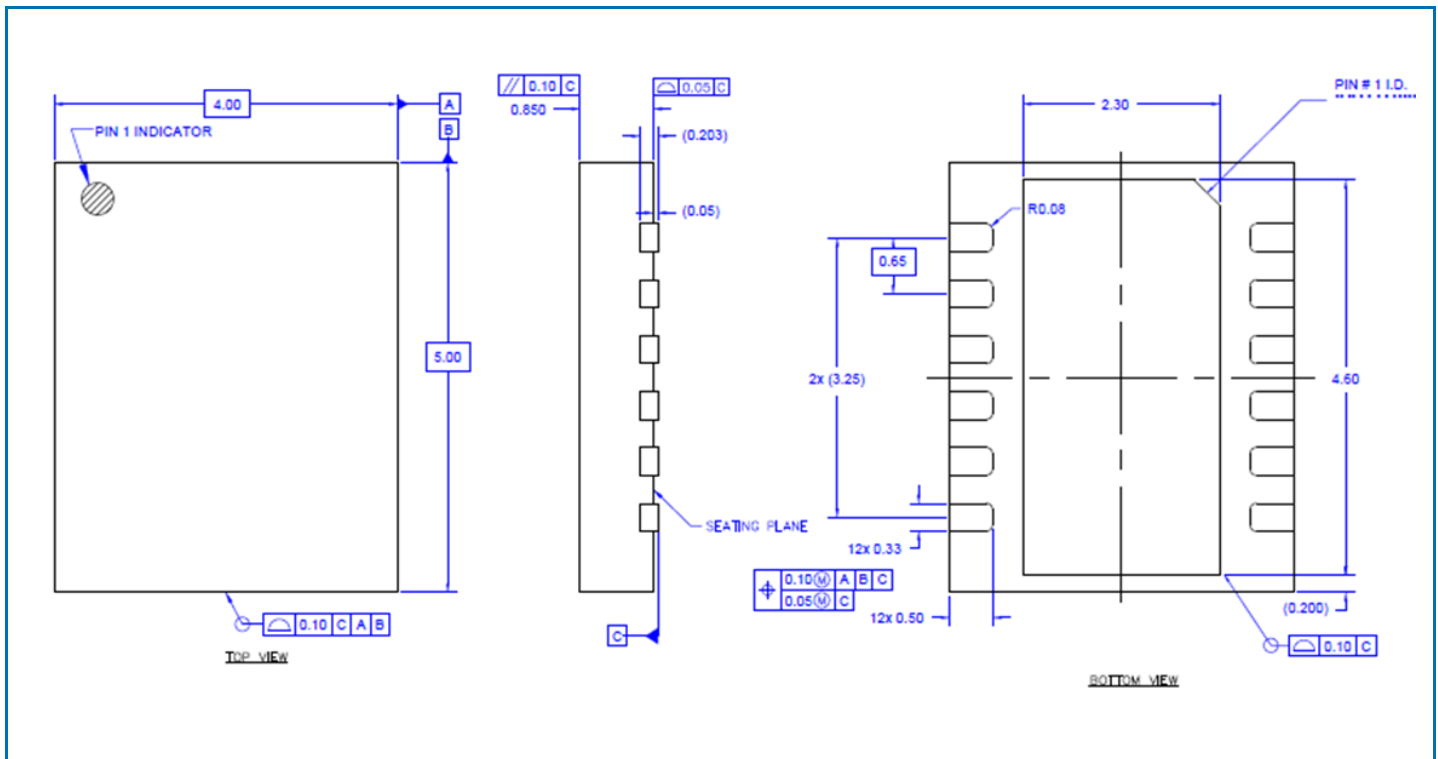

Branding Diagram

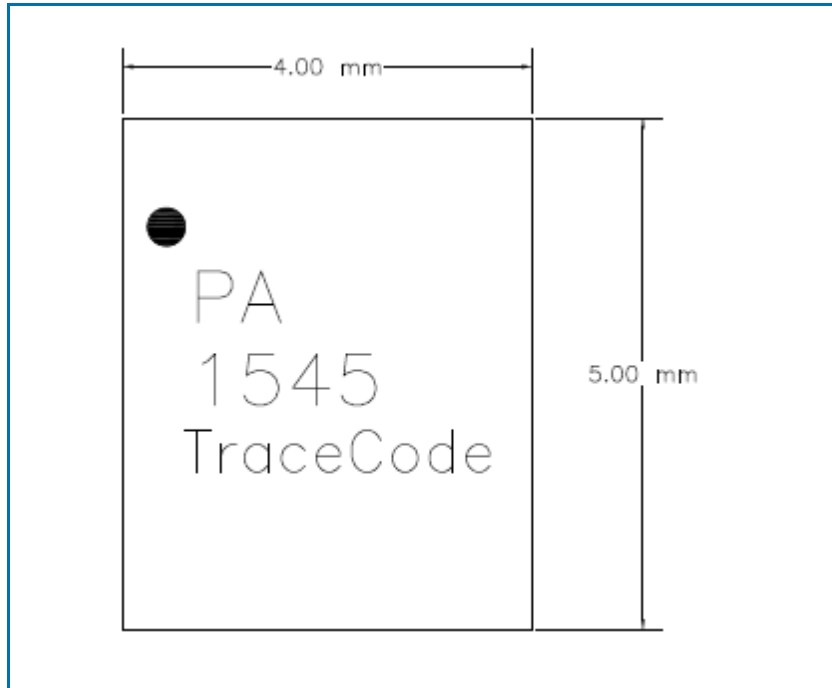

Contact Information

For the latest specifications, additional product information, worldwide sales and distribution locations:

Web: www.rfmd.com **Tel:** 1-844-890-8163
Email: customer.support@qorvo.com

For information about the merger of RFMD and TriQuint as Qorvo:

Web: www.qorvo.com

Important Notice

The information contained herein is believed to be reliable. RFMD makes no warranties regarding the information contained herein. RFMD assumes no responsibility or liability whatsoever for any of the information contained herein. RFMD assumes no responsibility or liability whatsoever for the use of the information contained herein. The information contained herein is provided "AS IS, WHERE IS" and with all faults, and the entire risk associated with such information is entirely with the user. All information contained herein is subject to change without notice. Customers should obtain and verify the latest relevant information before placing orders for RFMD products. The information contained herein or any use of such information does not grant, explicitly or implicitly, to any party any patent rights, licenses, or any other intellectual property rights, whether with regard to such information itself or anything described by such information.

RFMD products are not warranted or authorized for use as critical components in medical, life-saving, or life-sustaining applications, or other applications where a failure would reasonably be expected to cause severe personal injury or death.