



Features

- -60dBc ACPR at 16dBm WCDMA
- 0.5W Output Power (P1dB)
- Excellent Linearity to DC Power Ratio
- NF=3.0dB at 880MHz
- Single-Supply 5V Operation
- Class 1C (100V) HBM ESD

Applications

- GaAs Pre-Driver for Base Station Amplifiers
- PA Stage for Commercial Wireless Infrastructure
- 2nd or 3rd Stage LNAs
- Class AB Operation for GSM, DCS, PCS, UMTS, WiMAX, LTE Transceiver Applications

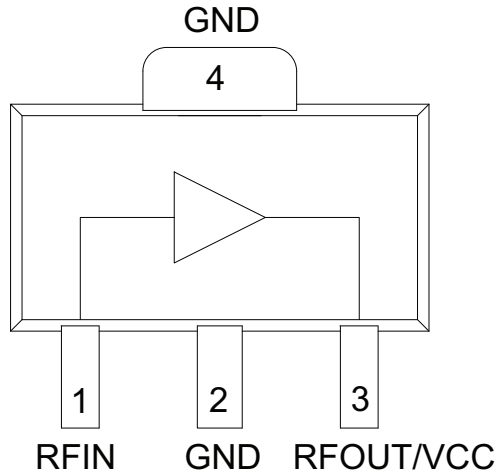

Functional Block Diagram

Product Description

The RFPA2189 is a single-stage GaAs HBT power amplifier specifically designed for Wireless Infrastructure applications. It offers ultra-linear operation at a comparably low DC power making it ideal for next generation radios requiring high efficiency. Its external matching allows for use across various radio platforms within 400MHz to 2700MHz. The RFPA2189 offers low noise figure making it an excellent solution for 2nd and 3rd stage LNAs.

Ordering Information

RFPA2189SR	7" Reel with 100 pieces
RFPA2189SQ	Sample bag with 25 pieces
RFPA2189TR7	7" Reel with 2500 pieces
RFPA2189PCK-410	869MHz to 894MHz PCBA with 5-piece sample bag
RFPA2189PCK-411	2110MHz to 2170MHz PCBA with 5-piece sample bag

Optimum Technology Matching® Applied

- | | | | |
|--|--------------------------------------|-------------------------------------|------------------------------------|
| <input checked="" type="checkbox"/> GaAs HBT | <input type="checkbox"/> SiGe BiCMOS | <input type="checkbox"/> GaAs pHEMT | <input type="checkbox"/> GaN HEMT |
| <input type="checkbox"/> GaAs MESFET | <input type="checkbox"/> Si BiCMOS | <input type="checkbox"/> Si CMOS | <input type="checkbox"/> BIFET HBT |
| <input type="checkbox"/> InGaP HBT | <input type="checkbox"/> SiGe HBT | <input type="checkbox"/> Si BJT | |

RF MICRO DEVICES®, RFMD®, Optimum Technology Matching®, Enabling Wireless Connectivity™, PowerStar®, POLARIS™ TOTAL RADIO™ and UltimateBlue™ are trademarks of RFMD, LLC. BLUETOOTH is a trademark owned by Bluetooth SIG, Inc., U.S.A. and licensed for use by RFMD. All other trade names, trademarks and registered trademarks are the property of their respective owners. ©2012, RF Micro Devices, Inc.

Absolute Maximum Ratings

Parameter	Rating	Unit
Supply Voltage (V_{CC})	6.0	V
DC Supply Current (I_C)	380	mA
CW Input Power, 50Ω output	20	dBm
Output Load VSWR at P3dB	5:1	
Operating Junction Temperature	160	°C
Operating Temperature Range (T_L)	-40 to +85	°C
Storage Temperature	-55 to +150	°C
ESD Rating – Human Body Model (HBM)	Class 1C	
Moisture Sensitivity Level	MSL2	

Notes:

- The maximum ratings must all be met simultaneously.
- $P_{DISS} = P_{DC} + P_{RFIN} - P_{RFOUT}$
- $T_J = T_L + P_{DISS} * R_{TH}$



Caution! ESD sensitive device.

Exceeding any one or a combination of the Absolute Maximum Rating conditions may cause permanent damage to the device. Extended application of Absolute Maximum Rating conditions to the device may reduce device reliability. Specified typical performance or functional operation of the device under Absolute Maximum Rating conditions is not implied.

The information in this publication is believed to be accurate and reliable. However, no responsibility is assumed by RF Micro Devices, Inc. ("RFMD") for its use, nor for any infringement of patents, or other rights of third parties, resulting from its use. No license is granted by implication or otherwise under any patent or patent rights of RFMD. RFMD reserves the right to change component circuitry, recommended application circuitry and specifications at any time without prior notice.

Parameter	Specification			Unit	Condition
	Min.	Typ.	Max.		
869 MHz to 894 MHz					
					$V_{CC}=5.0V, I_{CQ}=155mA$
Frequency	869	880	894	MHz	EVB tuned for optimum ACPR
Input Power (Pin)			13	dBm	Max recommended continuous input power, $V_{CC}<5.25V$, Load VSWR < 2:1
Gain (S21)		19.5		dB	
OIP3		43		dBm	15 dBm/tone, tone spacing=1 MHz
P1dB		27.5		dBm	EVB tuned for linear operation
Input Return Loss (S11)		13		dB	
Output Return Loss (S22)		13		dB	
Noise Figure		2.8		dB	
WCDMA Channel Power at -55dBc ACPR		17		dBm	3GPP 3.5, Test Model 1, 64 DPCH
UMTS 2100MHz					
					$V_{CC}=5.0V, I_{CQ}=155mA$
Frequency	2110	2140	2170	MHz	EVB tuned for optimum ACPR
Input Power (Pin)			18	dBm	Max recommended continuous input power, $V_{CC}<5.25V$, Load VSWR < 2:1
Gain (S21)		14.5		dB	
OIP3		42.5		dBm	15 dBm/tone, tone spacing=1 MHz
P1dB		27		dBm	EVB tuned for linear operation
Input Return Loss (S11)		13		dB	
Output Return Loss (S22)		13		dB	
Noise Figure		2.8		dB	
WCDMA Channel Power at -55dBc ACPR		16.8		dBm	3GPP 3.5, Test Model 1, 64 DPCH
Power Supply					
Operating Current (Quiescent)		155		mA	At $V_{CC}=5.0V$
Operating Voltage (V_{CC})		5.0	5.25	V	Max recommended collector voltage for continuous operation
Thermal Resistance (R_{TH})		58		C/W	At $V_{CC}=5.0V$

Typical Performance – 869MHz to 894MHz Application Circuit

S11 versus Frequency

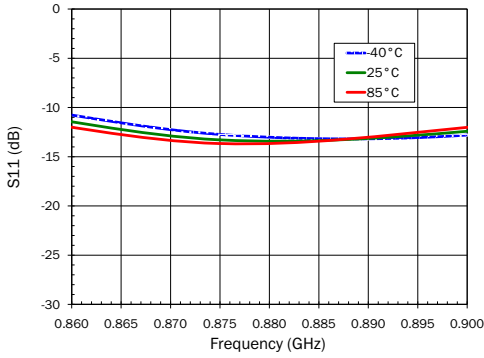

S21 versus Frequency

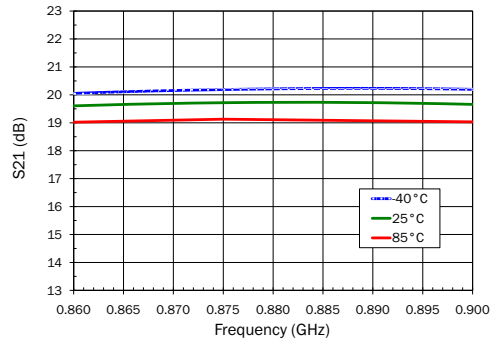

S12 versus Frequency

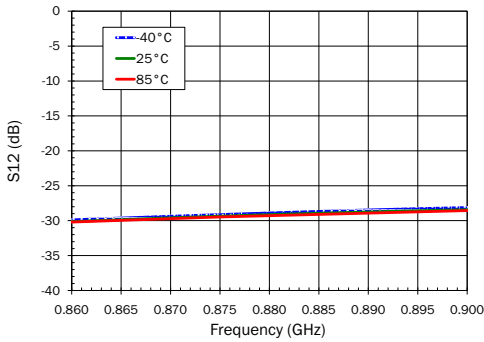

S22 versus Frequency

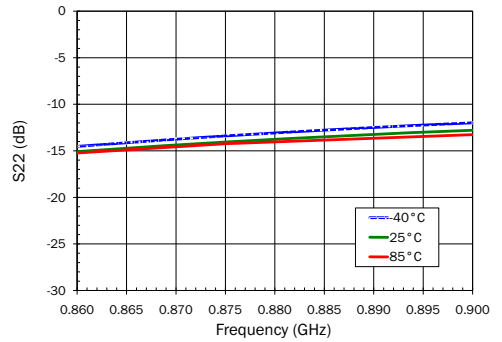

NF versus Frequency

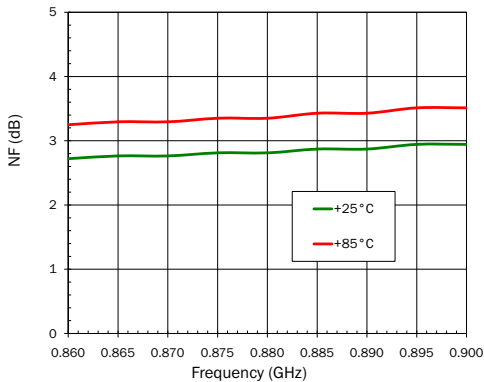

P1dB versus Frequency

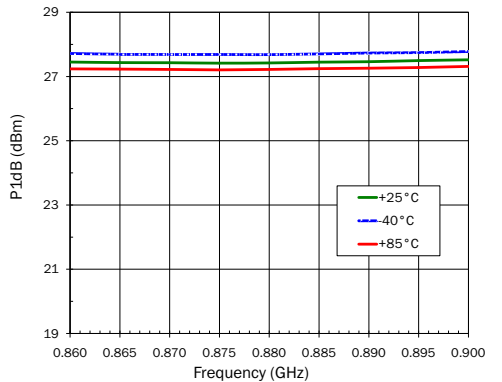

Typical Performance – 869MHz to 894MHz Application Circuit

OIP3 versus Frequency (15dBm tones)

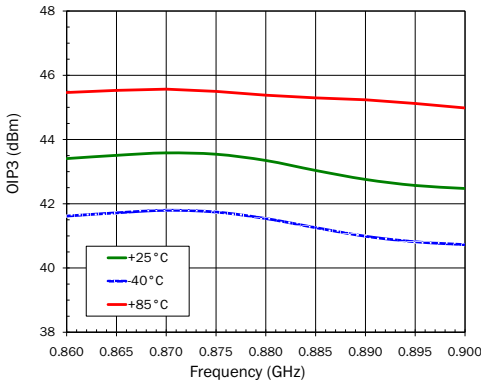

Pout & Current versus Pin @ 880MHz

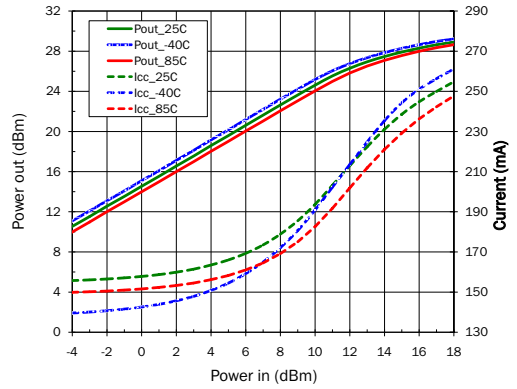

OIP3 versus Power Out (880 MHz)

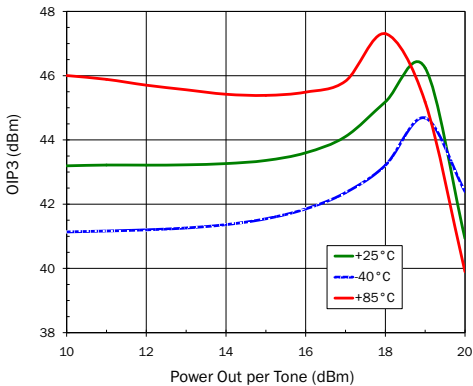

ACP versus Power Out (25°C)

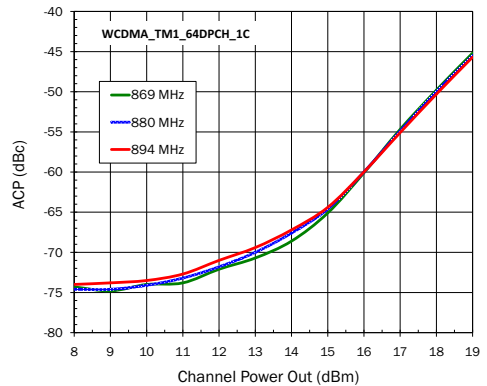

Current vs. Voltage

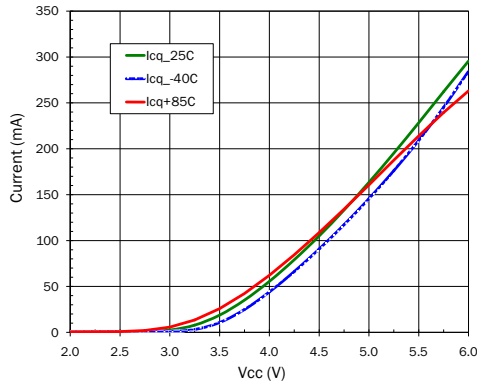

ACP versus Power Out (880MHz)

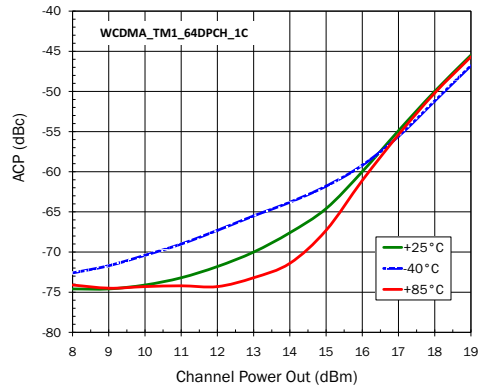

Evaluation Board Schematic 869MHz to 894MHz Application Circuit

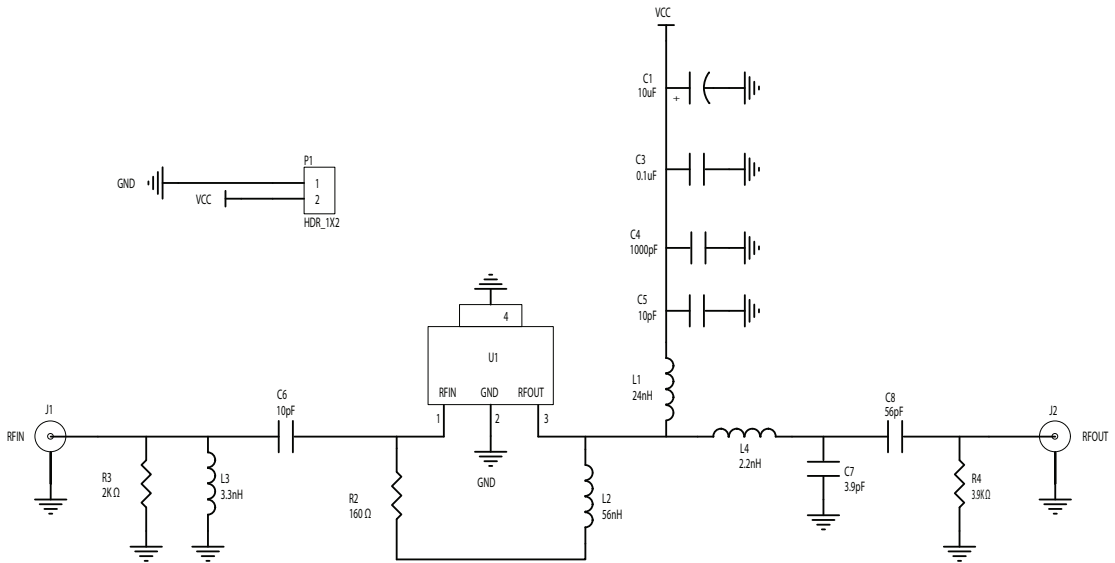

Evaluation Board Bill of Materials (BOM) 869MHz to 894MHz Application Circuit

Description	Reference Designator	Manufacturer	Manufacturer's P/N
PCB			PA2189410(A)
GaAs HBT Power Amplifier	U1	RFMD	RFPA2189
CAP, 10 uF, 20%, 10V, TANT-A	C1	Kemet	T491A106M010AT
CAP, 1000 pF, 10%, 50V, X7R, 0603	C4	Panasonic	ECJ-1VB1H102K
CAP, 0.1 uF, 10%, 16V, X7R, 0603	C3	Murata Electronics	GRM188R71C104KA01D
CAP, 10 pF, 5%, 50V, COG, 0603	C5	Johanson Technology	500R14N100JV4
CAP, 10 pF, 5%, 50V, COG, 0402	C6	Murata Electronics	GRM1555C1H100JZ01E
CAP, 3.9 pF, +/-0.25 pF, 50V, COG, 0402	C7	Murata Electronics	GRM1555C1H3R9CZ01E
CAP, 56 pF, 5%, 50V, COG, 0402	C8	Murata Electronics	GRM1555C1H560JZ01D
CONN, SMA, END LNCH, MINI, FLT, 0.068"	J1, J2	Emerson Networks	142-0741-851
IND, 24 nH, 5%, W/W, 0603	L1	Coilcraft, Inc.	0603HC-24NXJLW
IND, 56 nH, 5%, M/L, 0402	L2	TOKO	LL1005-FHL56NJ
IND, 3.3 nH, +/- 0.3 nH, M/L, 0603	L3	TOKO	LL1608-FSL3N3S
IND, 2.2 nH, +/-0.3 nH, M/L, 0603	L4	TOKO	LL1608-FSL2N2S
CONN, HDR, ST, PLRZD, 2-PIN, 0.100"	P1	ITW Pancon	MPSS100-2-C
RES, 160Ω, 5%, 1/16W, 0402	R2	Kamaya, Inc	RMC1/16S-161JTH
RES, 2K, 5%, 1/16W, 0402	R3	Panasonic	ERJ-2GEJ202
RES, 3.9K, 5%, 1/16W, 0402	R4	Panasonic	ERJ-2GEJ392
DNP	R1, C2, J3, J4		

Evaluation Board Assembly Drawing 869 MHz to 894 MHz Application Circuit

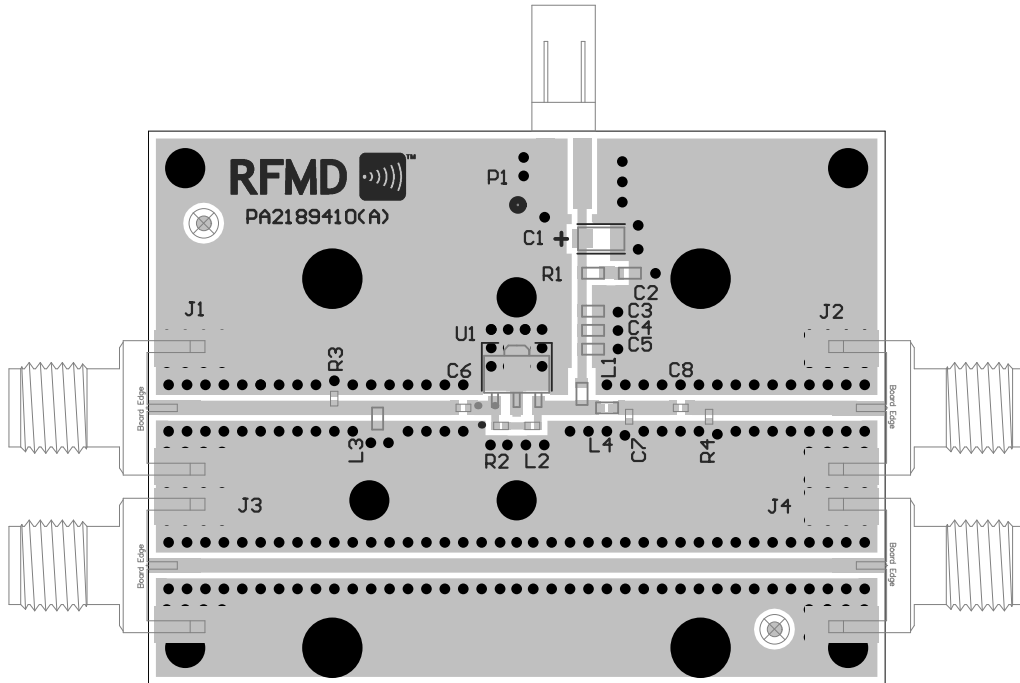

(Refer to Schematic and BOM for specific component requirements, some items in the EVB drawing are DNP)

Typical Performance – 2110MHz to 2170MHz Application Circuit

S11 versus Frequency

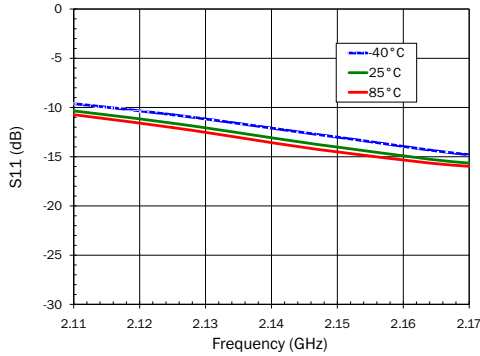

S21 versus Frequency

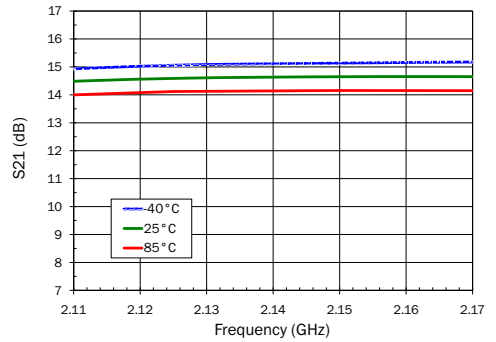

S12 versus Frequency

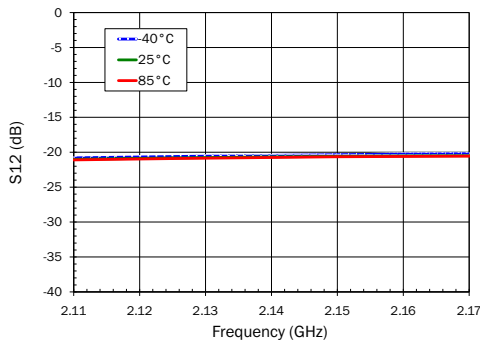

S22 versus Frequency

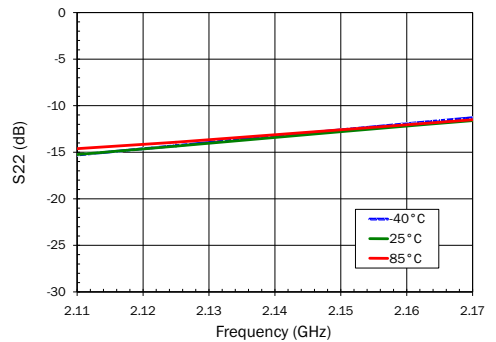

NF versus Frequency

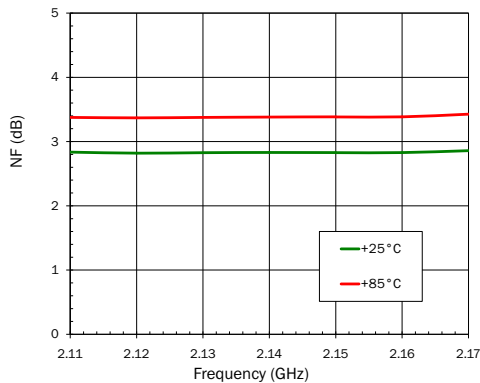

P1dB versus Frequency

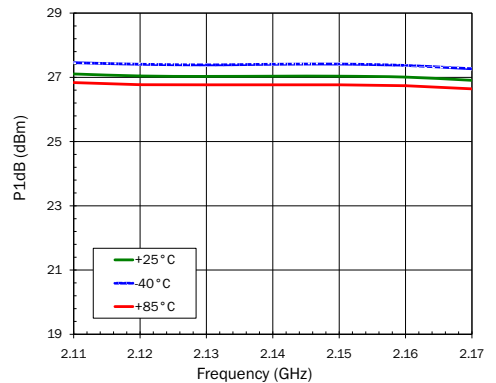

Typical Performance – 2110MHz to 2170MHz Application Circuit

OIP3 versus Frequency (15dBm tones)

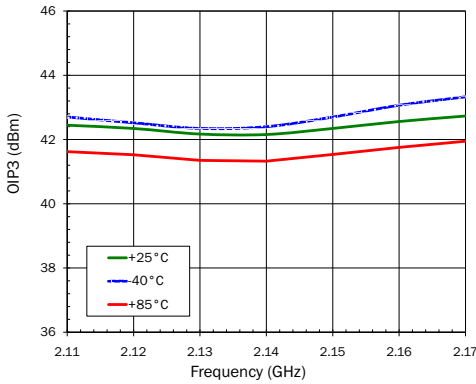

Pout & Current versus Pin @ 2140MHz

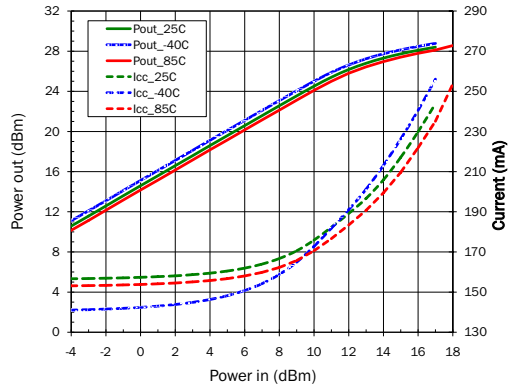

OIP3 versus Power Out (2140 MHz)

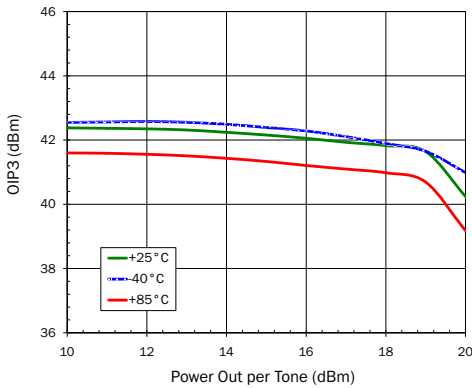

ACP versus Power Out (25°C)

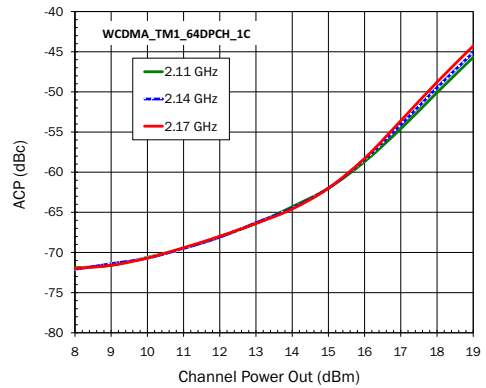

ACP versus Power Out (2140 MHz)

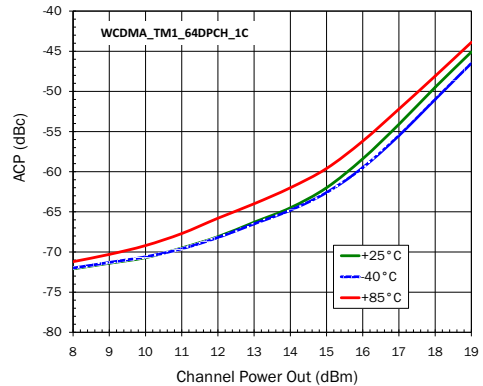

Evaluation Board Schematic 2110MHz to 2170MHz Application Circuit

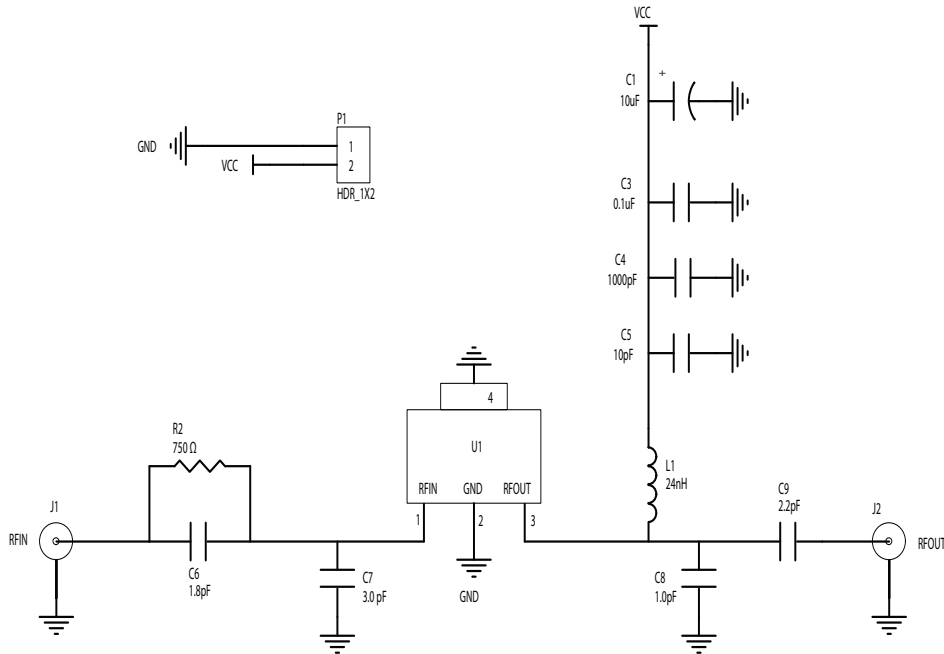

Evaluation Board Bill of Materials (BOM) 2110MHz to 2170MHz Application Circuit

Description	Reference Designator	Manufacturer	Manufacturer's P/N
PCB			PA2189411(A)
GaAs HBT Power Amplifier	U1	RFMD	RFPA2189
CAP, 10 uF, 20%, 10V, TANT-A	C1	Kemet	T491A106M010AT
CAP, 1000 pF, 10%, 50V, X7R, 0603	C4	Panasonic	ECJ-1VB1H102K
CAP, 0.1 uF, 10%, 16V, X7R, 0603	C3	Murata Electronics	GRM188R71C104KA01D
CAP, 10 pF, 5%, 50V, COG, 0603	C5	Johanson Technology	500R14N100JV4
CAP, 1.8 pF, +/-0.1pF, 50V, COG, 0402	C6	Murata Electronics	GRM1555C1H1R8BZ01E
CAP, 3 pF, +/-0.1pF, 50V, COG, 0402	C7	Murata Electronics	GRM1555C1H3R0BZ01E
CAP, 1 pF, +/-0.1pF, 50V, HI-Q, 0402	C8	Johanson Technology	500R07S1R0BV4TD
CAP, 2.2 pF, +/-0.1pF, 50V, HI-Q, 0402	C9	Johanson Technology	500R07S2R2BV4TD
CONN, SMA, END LNCH, MINI, FLT, 0.068"	J1, J2	Emerson Networks	142-0741-851
IND, 24 nH, 5%, W/W, 0603	L1	Coilcraft, Inc.	0603HC-24NXJLW
CONN, HDR, ST, PLRZD, 2-PIN, 0.100"	P1	ITW Pancon	MPSS100-2-C
RES, 750Ω, 1%, 1/16W, 0402	R2	Panasonic	ERJ-2RK7500X
DNP	R1, C2, J3, J4		

Evaluation Board Assembly Drawing 2110MHz to 2170MHz Application Circuit

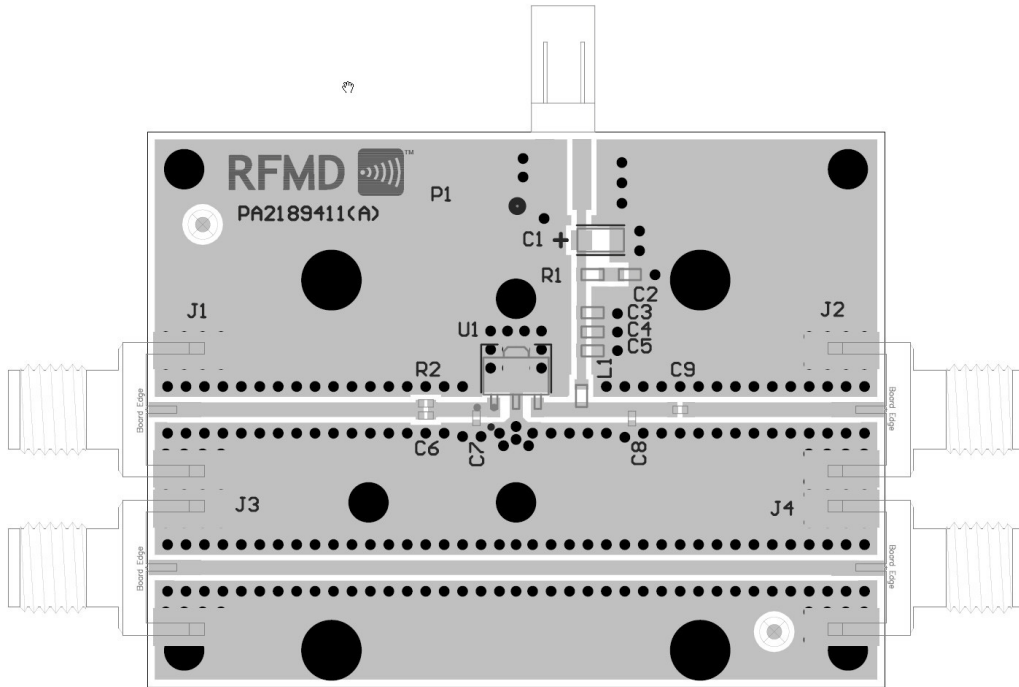

(Refer to Schematic and BOM for specific component requirements, some items in the EVB drawing are DNP)

Pin Names and Description

Pin	Function	Description
1	RF IN	RF Input. External DC Block is Required.
2	GND	DC and RF Ground
3	RF OUT/VCC	RF Output, Device Collector
4	GND	DC and RF Ground. Must be soldered to EVB ground plane over a bed of vias for thermal and RF performance.

Package Marking

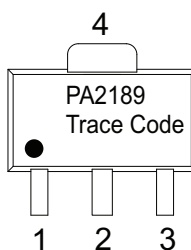

Trace Code to be assigned by the assembly SubCon.

Package Drawing

Dimensions in millimeters [inches]

Refer to drawing posted at www.rfmd.com for tolerances.

