

RFPD3210

GaAs/GaN Power Doubler Hybrid
45MHz to 1218MHz

The RFPD3210 is a Hybrid Power Doubler amplifier module. The part employs GaAs pHEMT die and GaN HEMT die, has high output capability, and operates from 45MHz to 1218MHz. It provides excellent linearity and superior return loss performance with low noise and optimal reliability.

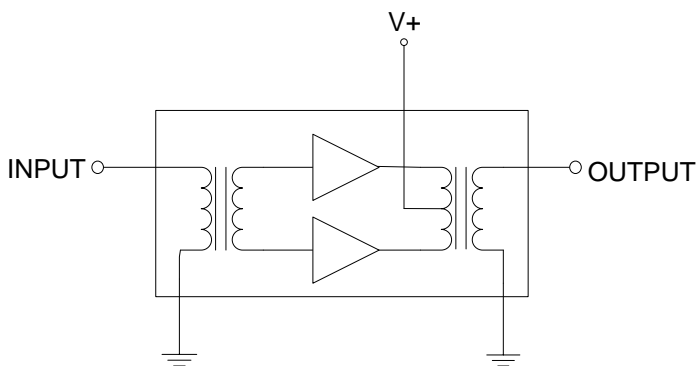

Ordering Information

RFPD3210 Box with 50 pieces

Absolute Maximum Ratings

Parameter	Rating	Unit
RF Input Voltage (single tone)	75	dBmV
DC Supply Over-Voltage (5 minutes)	30	V
Storage Temperature	-40 to +100	°C
Operating Mounting Base Temperature	-30 to +100	°C



Package: SOT-115J

Features

- Excellent Linearity
- Superior Return Loss Performance
- Extremely Low Distortion
- Optimal Reliability
- Low Noise
- Unconditionally Stable Under All Terminations
- Extremely High Output Capability
- 22.5dB Min. Gain at 1218MHz
- 480mA Max. at 24V_{DC}

Applications

- 45MHz to 1218MHz CATV Amplifier Systems



Caution! ESD sensitive device.



RoHS (Restriction of Hazardous Substances): Compliant per EU Directive 2011/65/EU.

Exceeding any one or a combination of the Absolute Maximum Rating conditions may cause permanent damage to the device. Extended application of Absolute Maximum Rating conditions to the device may reduce device reliability. Specified typical performance or functional operation of the device under Absolute Maximum Rating conditions is not implied.

Nominal Operating Parameters

Parameter	Specification			Unit	Condition
	Min	Typ	Max		
General Performance					$V_+ = 24V$; $T_{MB} = 30^\circ C$; $Z_S = Z_L = 75\Omega$
Power Gain	21.3	21.8	22.3	dB	$f = 45MHz$
	22.5	22.8	24.0	dB	$f = 1218MHz$
Slope ^[1]	0.5	1.0	2.0	dB	$f = 45MHz$ to $1218MHz$
Flatness of Frequency Response			0.8	dB	$f = 45MHz$ to $1218MHz$
Input Return Loss	20			dB	$f = 45MHz$ to $320MHz$
	19			dB	$f = 320MHz$ to $640MHz$
	18			dB	$f = 640MHz$ to $870MHz$
	18			dB	$f = 870MHz$ to $1000MHz$
	17			dB	$f = 1000MHz$ to $1218MHz$
Output Return Loss	20			dB	$f = 45MHz$ to $320MHz$
	19			dB	$f = 320MHz$ to $640MHz$
	18			dB	$f = 640MHz$ to $870MHz$
	18			dB	$f = 870MHz$ to $1000MHz$
	17			dB	$f = 1000MHz$ to $1218MHz$
Noise Figure		3.0	4.0	dB	$f = 50MHz$ to $1218MHz$
Total Current Consumption (DC)		470	480	mA	
Distortion Data 40MHz to 550MHz					$V_+ = 24V$; $T_{MB} = 30^\circ C$; $Z_S = Z_L = 75\Omega$
CTB		-73	-68	dBc	$V_O = 62dBmV$ at $1000MHz$, 18dB extrapolated tilt, 79 analog channels plus 75 digital channels (-6dB offset) ^{[2][4]}
XMOD		-68	-63	dBc	
CSO		-76	-70	dBc	
CIN	55	57		dB	
Distortion Data 40MHz to 550MHz					$V_+ = 24V$; $T_{MB} = 30^\circ C$; $Z_S = Z_L = 75\Omega$
CTB		-78		dBc	$V_O = 62dBmV$ at $1218MHz$, 22dB extrapolated tilt, 79 analog channels plus 111 digital channels (-6dB offset) ^{[3][4]}
XMOD		-77		dBc	
CSO		-80		dBc	
CIN		58		dB	

- The slope is defined as the difference between the gain at the start frequency and the gain at the stop frequency.
- 79 analog channels, NTSC frequency raster: 55.25MHz to 547.25MHz, +44dBmV to +53.4dBmV tilted output level, plus 75 digital channels, -6dB offset relative to the equivalent analog carrier.
- 79 analog channels, NTSC frequency raster: 55.25MHz to 547.25MHz, +40dBmV to +49.4dBmV tilted output level, plus 111 digital channels, -6dB offset relative to the equivalent analog carrier.
- Composite Second Order (CSO) - The CSO parameter (both sum and difference products) is defined by the NCTA. Composite Triple Beat (CTB) - The CTB parameter is defined by the NCTA. Cross Modulation (XMOD) - Cross modulation (XMOD) is measured at baseband (selective voltmeter method), referenced to 100% modulation of the carrier being tested. Carrier to Intermodulation Noise (CIN) - The CIN parameter is defined by ANSI/SCTE 17 (Test procedure for carrier to noise).

Package Drawing (Dimensions in millimeters)

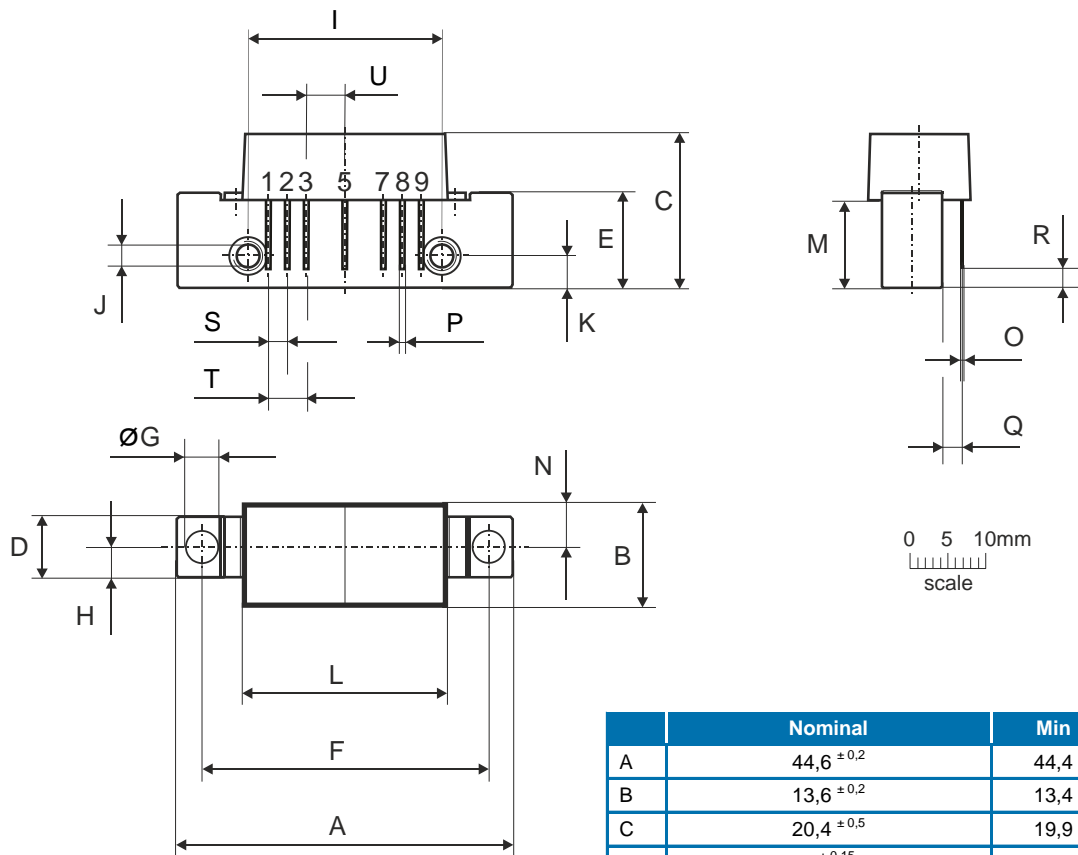

Notes:

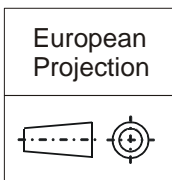

Pinning:

Pin	Name
1	Input
2-3	GND
4	
5	V+
6	
7-8	GND
9	Output

	Nominal	Min	Max
A	44,6 ±0,2	44,4	44,8
B	13,6 ±0,2	13,4	13,8
C	20,4 ±0,5	19,9	20,9
D	8 ±0,15	7,85	8,15
E	12,6 ±0,15	12,45	12,75
F	38,1 ±0,2	37,9	38,3
G	4 +0,2/-0,05	3,95	4,2
H	4 ±0,2	3,8	4,2
I	25,4 ±0,2	25,2	25,6
J	UNC 6-32	-	-
K	4,2 ±0,2	4,0	4,4
L	27,2 ±0,2	27,0	27,4
M	11,6 ±0,5	11,1	12,1
N	5,8 ±0,4	5,4	6,2
O	0,25 ±0,02	0,23	0,27
P	0,45 ±0,03	0,42	0,48
Q	2,54 ±0,3	2,24	2,84
R	2,54 ±0,5	2,04	3,04
S	2,54 ±0,25	2,29	2,79
T	5,08 ±0,25	4,83	5,33
U	5,08 ±0,25	4,83	5,33