

RFVC1837

11.1GHz to 12.5GHz MMIC VCO with Fo/2 and Fo/4 Outputs

RFMD's RFVC1837 is a 5V InGaP MMIC VCO with an integrated frequency divider providing additional Fo/2 and Fo/4 outputs. With an Fo frequency range of 11.1GHz to 12.5GHz its monolithic structure provides excellent temperature, shock, and vibration performance. Output power (Fo) is +8dBm and is flat across the tuning voltage range of 1.5V to 14.5V. Phase noise is typically -113dBc/Hz at 100kHz offset. The device operates from a low supply current of 265mA which can be further reduced to 205mA by disabling the divider functions if not required. The RFVC1837 is available in a low cost 5mm x 5mm surface mount plastic overmolded QFN outline.

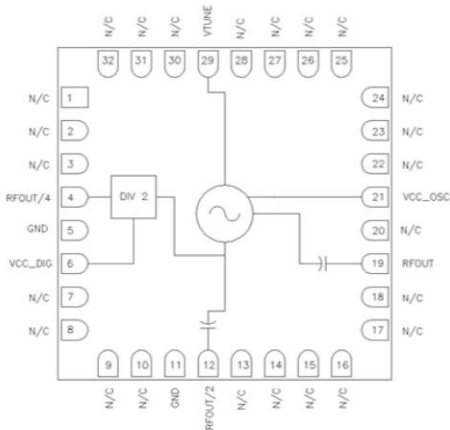

Functional Block Diagram

Ordering Information

RFVC1837S2	Sample bag with 2 pieces
RFVC1837SB	Sample bag with 5 pieces
RFVC1837SQ	Bag with 25 pieces
RFVC1837SR	Bag with 100 pieces
RFVC1837TR7	7" Reel with 750 pieces
RFVC1837PCBA-410	Evaluation Board



Package: Plastic QFN, 32-pin, 5mm x 5mm x 0.85mm

Features

- Multiple Frequency Outputs
 - Fo: 11.1GHz to 12.5GHz
 - Fo/2: 5.55GHz to 6.25GHz
 - Fo/4: 2.78GHz to 3.13GHz
- No External Resonator Required
- Integrated Frequency Divider
- Phase Noise: -113dBc/Hz at 100kHz Offset
- Flat Output Power Over Frequency Tuning Range 1.5V to 14.5V
 - Fo: 8dBm
 - Fo/2: 8dBm
 - Fo/4: -2dBm
- Low Power Consumption
 - 5V/265mA (Divider On)
 - 5V/205mA (Divider Off)
- 32-Lead 5mm x 5mm Plastic Overmolded QFN

Applications

- Point-to-Point Radio
- Point-to-Multipoint Radio
- Satellite Communications
- Test Equipment
- Military
- Aerospace

Absolute Maximum Ratings

Parameter	Rating	Unit
V_{CC_OSC}, V_{CC_DIG}	+5.5	V
V_{TUNE}	0 to +15	V
Junction Temperature (T_J)	135	°C
Continuous P_{DISS} ($T_A = 85^\circ\text{C}$) (derate 37mW/°C above $T_A = 85^\circ\text{C}$)	1.65	W
Junction to Case, Thermal Resistance ($R_{\theta(j-c)}$)	30	°C/W
Storage Temperature	-65 to +150	°C
Operating Temperature	-40 to +85	°C
ESD Sensitivity (HBM)	Class 1A	



Caution! ESD sensitive device.



RFMD Green: RoHS compliant per EU Directive 2011/65/EU, halogen free per IEC 61249-2-21, <1000ppm each of antimony trioxide in polymeric materials and red phosphorus as a flame retardant, and <2% antimony solder.

Exceeding any one or a combination of the Absolute Maximum Rating conditions may cause permanent damage to the device. Extended application of Absolute Maximum Rating conditions to the device may reduce device reliability. Specified typical performance or functional operation of the device under Absolute Maximum Rating conditions is not implied.

Nominal Operating Parameters

Parameter	Specification			Unit	Condition
	Min	Typ	Max		
Electrical Specifications					$V_{CC} = 5V, T_A = +25^\circ\text{C}$
Operating Frequency					
Fo	11.1		12.5	GHz	
Fo/2	5.55		6.25	GHz	
Fo/4	2.78		3.13	GHz	
Output Power					
Fo		8		dBm	
Fo/2		8		dBm	
Fo/4		-2		dBm	
SSB Phase Noise					
10kHz offset at RF_{OUT}		-88		dBc/Hz	$V_{TUNE} = 5V$
100kHz offset at RF_{OUT}		-113		dBc/Hz	
Tune Voltage	1.5		14.5	V	
Supply Current					
V_{CC_OSC}		205		mA	
V_{CC_DIG}		60		mA	
Tune Port Leakage Current		10		μA	
Output Return Loss		5		dB	

Parameter	Specification			Unit	Condition
	Min	Typ	Max		
Electrical Specifications (continued)					
Harmonics/Sub-harmonics					Measured with RF probes at package, not at SMA connections on EVB
1/2		40		dBc	
3/2		35		dBc	
2 nd		9		dBc	
3 rd		18		dBc	
Pulling (into a 2.0:1 VSWR)		5		MHz pp	
Pushing		20		MHz/V	
Frequency Drift Rate		1		MHz/°C	

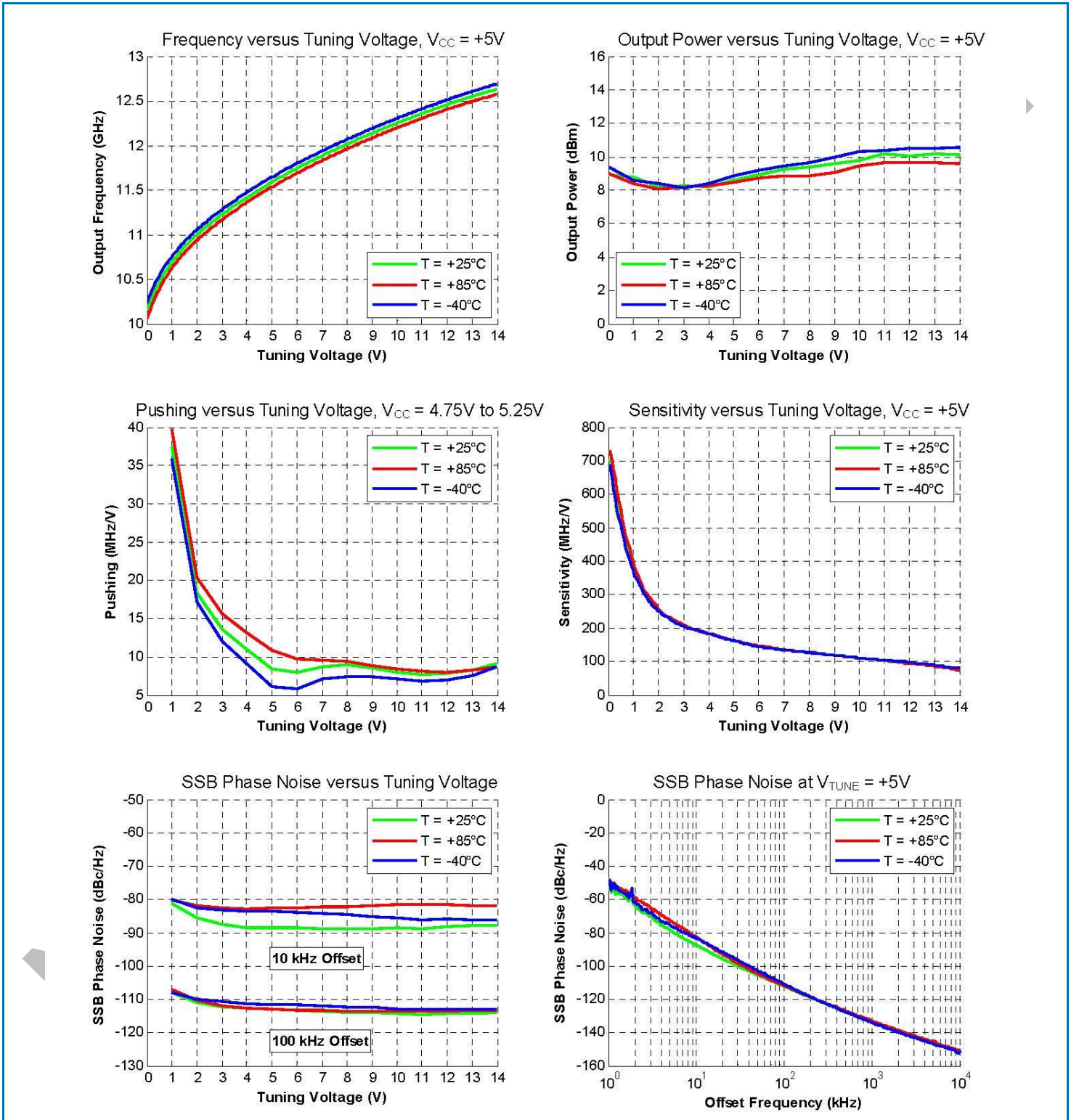

Typical Performance

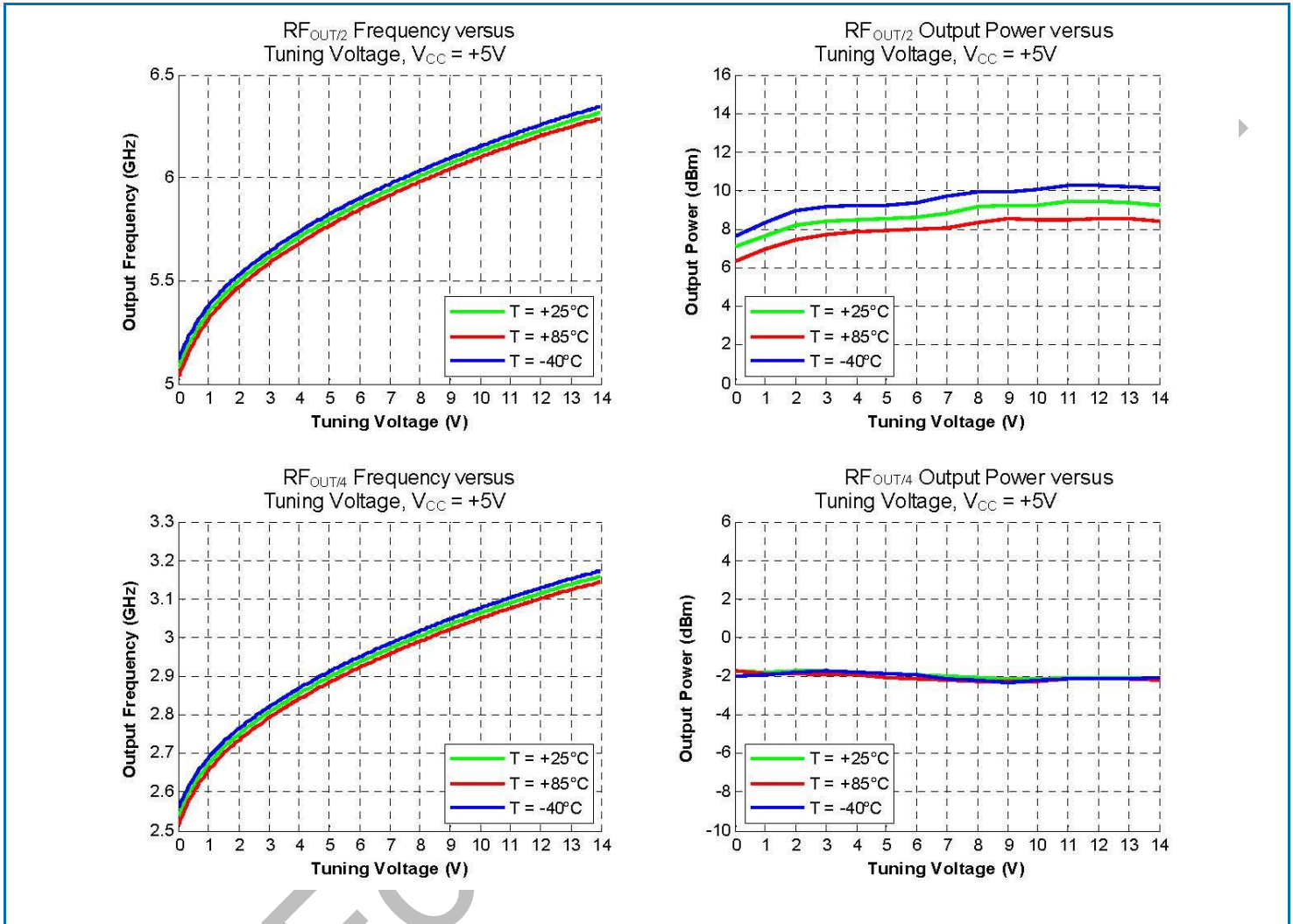

Typical Performance (continued)

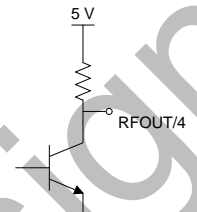

Pin Names and Descriptions

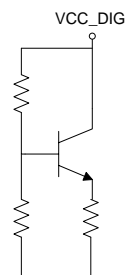
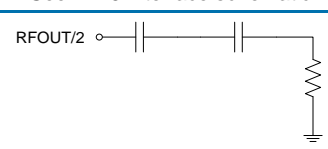
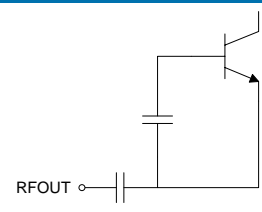
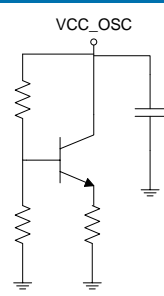
Pin	Name	Description	Interface Schematic
1-3	N/C	No internal connection.	
4	RFOUT/4	VCO RF output at $F_o/4$. Externally DC-blocked.	
5	GND	Connect to PCB ground.	
6	VCC_DIG	Supply voltage input for the integrated frequency divider. Typical +5V. Ground this pin to disable digital divider and reduce current consumption by 60mA.	
7-10	N/C	No internal connection.	
11	GND	Connect to PCB ground.	See Pin 5 interface schematic
12	RFOUT/2	VCO RF output at $F_o/2$. Internally DC-blocked.	
13-18	N/C	No internal connection.	
19	RFOUT	VCO RF output at F_o . Internally DC-blocked.	
20	N/C	No internal connection.	
21	VCC_OSC	Supply voltage input for the VCO. Typical +5V.	

Pin Names and Descriptions (continued)

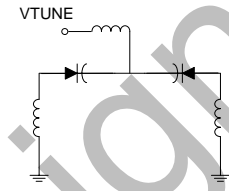
Pin	Name	Description	Interface Schematic
22-28	N/C	No internal connection.	
29	VTUNE	VCO control voltage input.	
30-32	N/C	No internal connection.	
PKG BASE	GND	Connect to PCB ground.	See Pin 5 interface schematic

Package Drawing (all dimensions in mm)

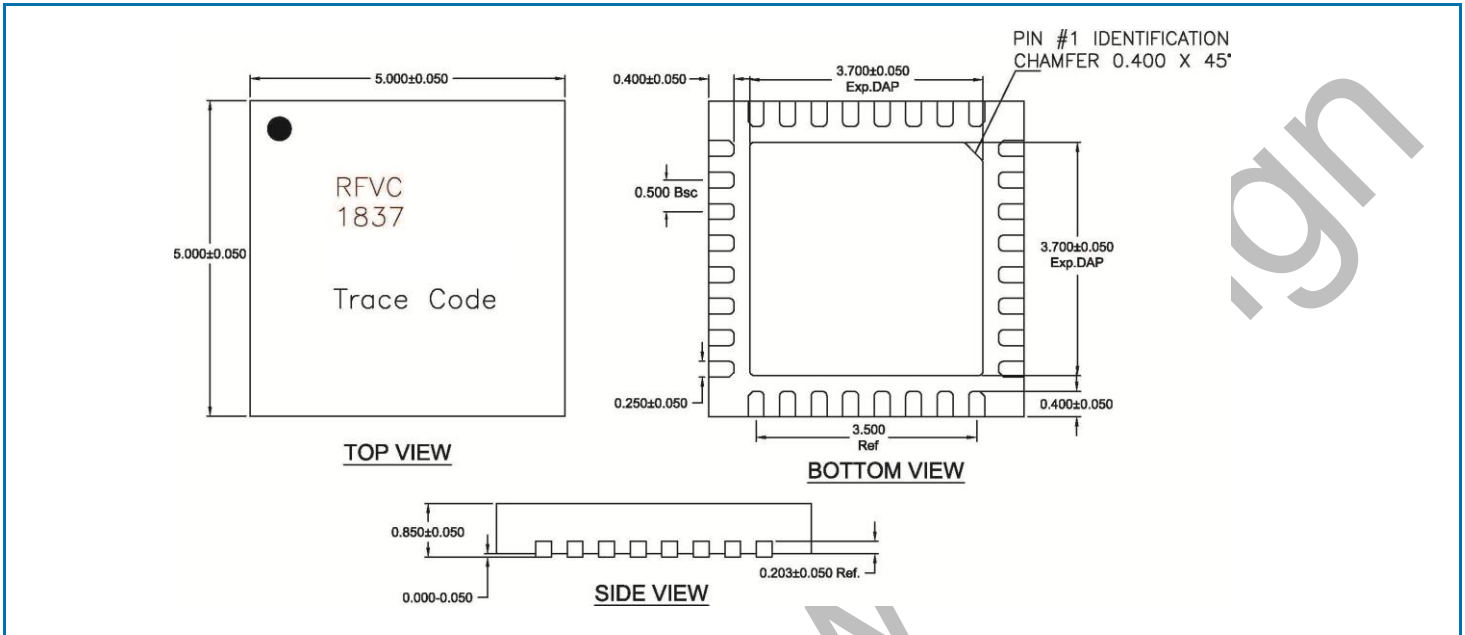

Notes:

1. Dimensions are for reference only.
2. Package body material: Plastic.
3. Lead and paddle plating: $8\mu\text{m}$ minimum of Sn over Cu leadframe.

Recommended PCB Layout

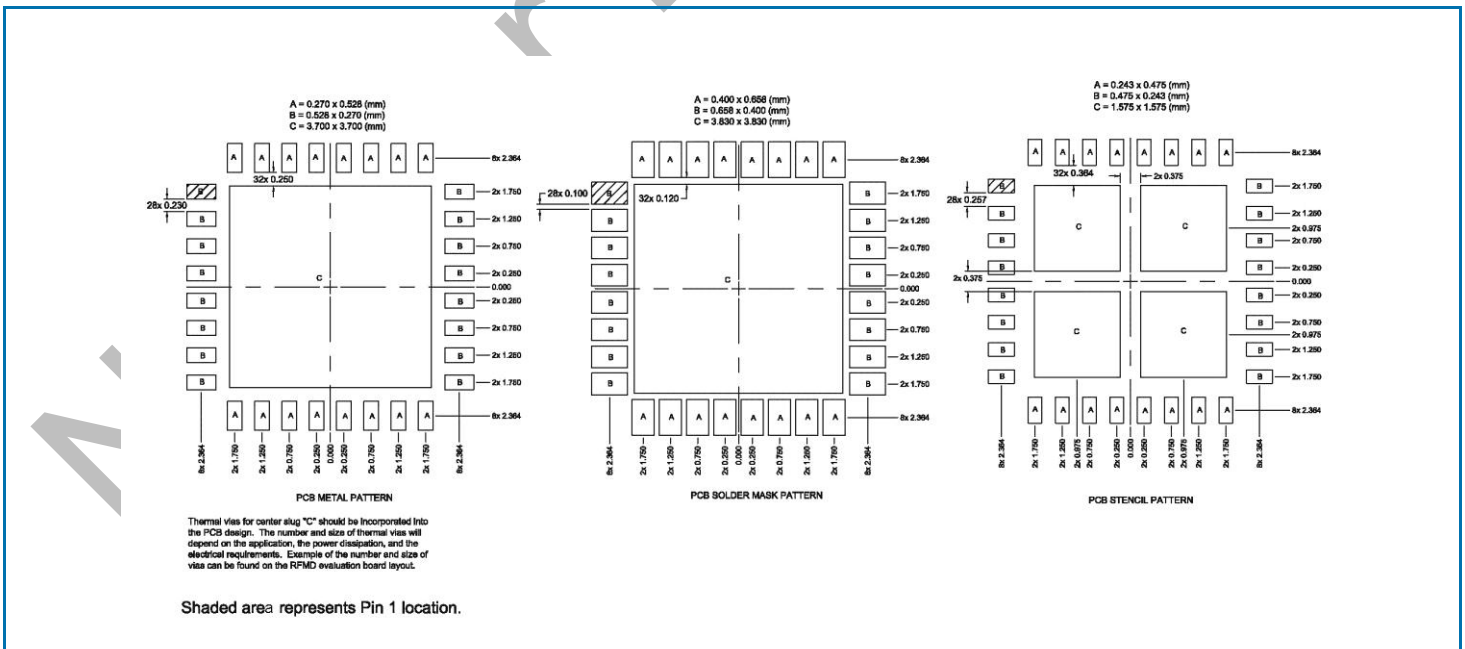

Sample Application Circuit Schematic

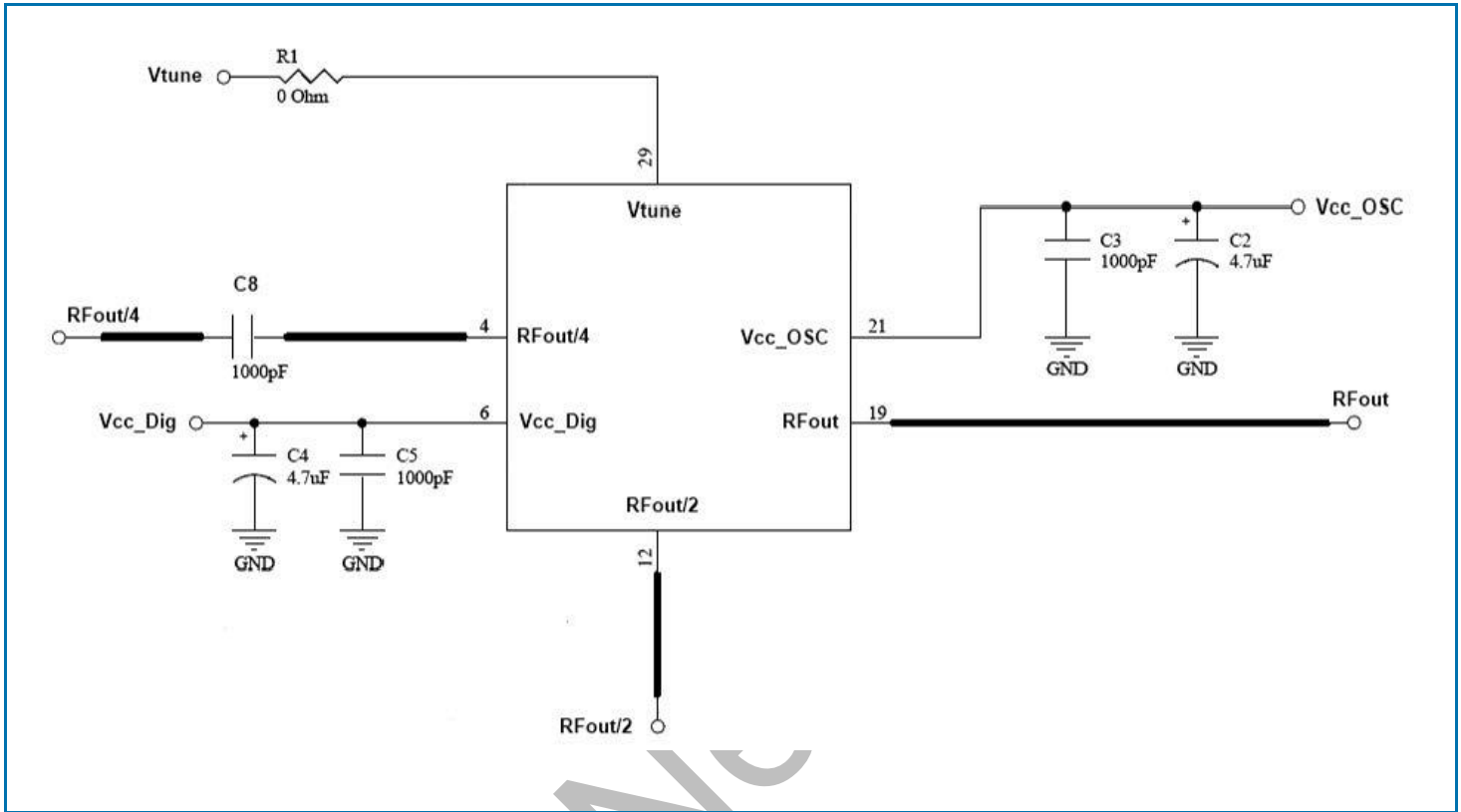

Bias Conditions	Output
V _{CC_OSC} = 5V	F _{OUT} = 11.6GHz
V _{CC_DIG} = 5V	F _{OUT/2} = 5.8GHz
V _{TUNE} = 5V	F _{OUT/4} = 2.9GHz

Evaluation Board Layout

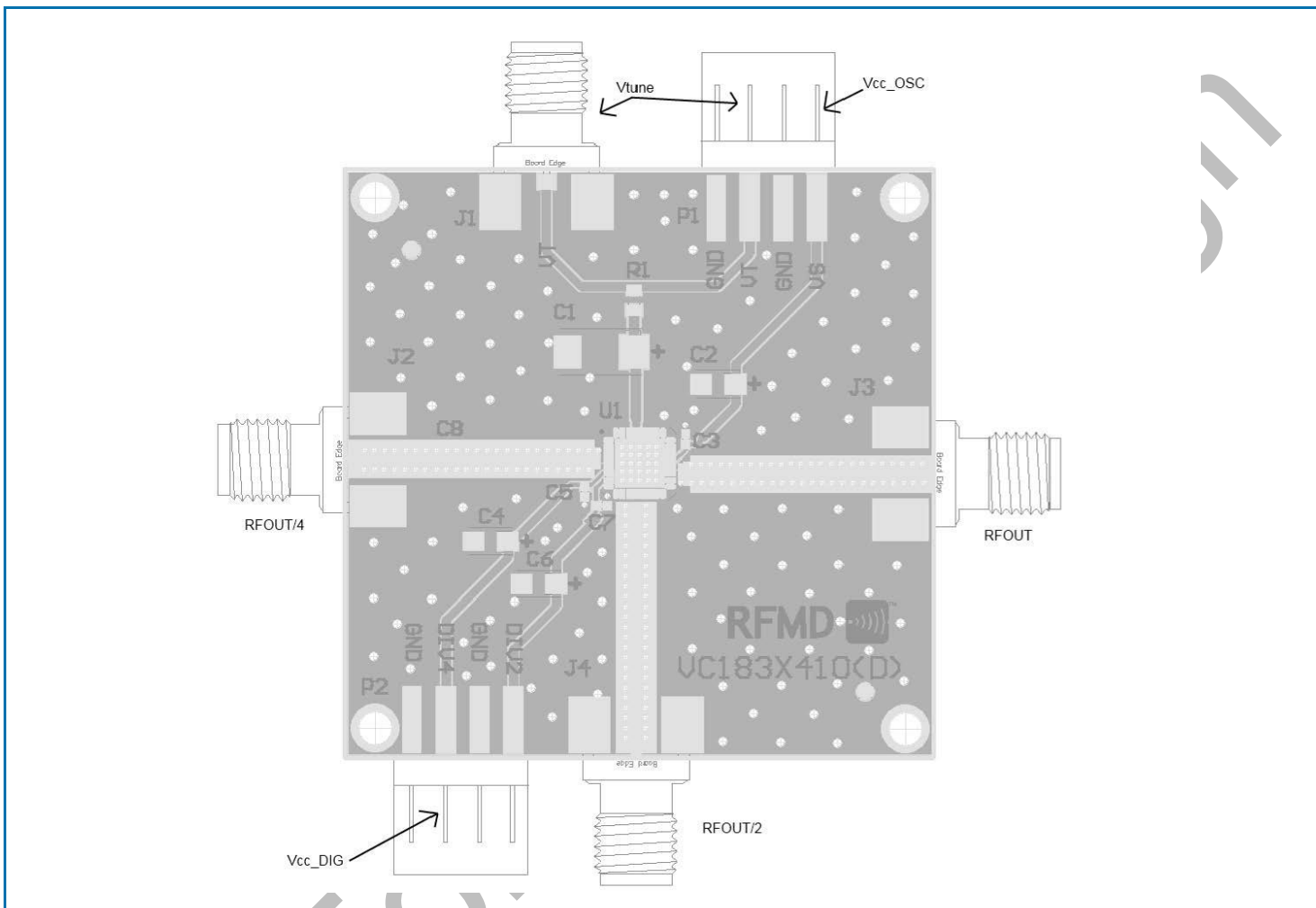

Evaluation Board Bill of Materials (BOM)

Item	Description
U1	RFVC1837 VCO
C3, C5, C7, C8	1000pF Capacitor, 0402 Package
C2, C4, C6	4.7µF Tantalum Capacitor
C1	68µF Tantalum Capacitor
R1	0Ω Resistor, 0603 Package
P1, P2	4-PIN DC connector
J1, J2, J3, J4	PCB mount SMA connector
PCB	VC183x410(D)