

Product Description

The RFXF0008H transformer is designed for applications that require small, low cost and highly reliable surface mount components. Applications may be found in broadband, wireless and other communications systems. These units are built lead-free and RoHS compliant. S-Parameters are available on request.

Functional Block Diagram

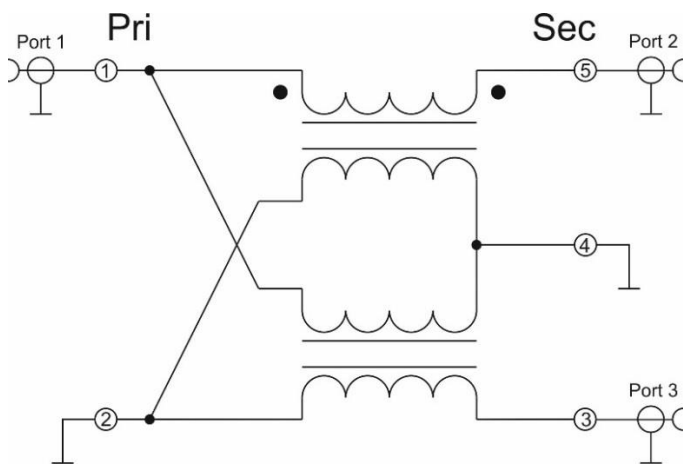

Package: SP6

Product Features

- 45MHz to 1218MHz Operation
- Low Cost and RoHS Compliant
- Industry Standard SMT Package
- Available in Tape-and-Reel
- 75 Ω Characteristic Impedance

Applications

- Broadband / CATV
- Wireless

Ordering Information

Part No.	Description
RFXF0008HSB	Sample bag with 5 pcs
RFXF0008HSQ	Sample bag with 25 pcs
RFXF0008HSR	13" Sample reel with 100 pcs
RFXF0008HTR13	13" Sample reel with 1000 pcs

RFXF0008H Absolute Maximum Ratings

Parameter	Value / Range
RF Power	2 W
Storage Temperature Range	-55 to 100 °C
Operating Temperature Range	-40 to 100 °C

Operation of this device outside the parameter ranges given above may cause permanent damage.

Nominal Operating Parameters

Parameter	Test Conditions: $T_{MB}=25^{\circ}C$	Min	Typ	Max	Unit
General Performance. Typical values represent Mid Band performance at $T=25^{\circ}C$					
Operational Frequency Range	–	40	–	1218	MHz
Insertion Loss	$f_o=$ 45 to 200 MHz		1.6	2.0	dB
	$f_o=$ 200 to 600 MHz		1.5	2.0	
	$f_o=$ 600 to 1000 MHz		1.9	2.5	
	$f_o=$ 1000 to 1218 MHz		2.2	2.8	
Input Return Loss	$f_o=$ 45 MHz	12	14		dB
	$f_o=$ 45 to 100 MHz	12	14		dB
	$f_o=$ 100 to 400 MHz	15	17		dB
	$f_o=$ 400 to 700 MHz	14	16		dB
	$f_o=$ 700 to 1000 MHz	12	16		dB
	$f_o=$ 1000 to 1218 MHz	11	14		dB
Amplitude Balance	$f_o=$ 45 to 200 MHz		0.3	0.5	dB
	$f_o=$ 200 to 600 MHz		0.4	1.0	dB
	$f_o=$ 600 to 1000 MHz		0.4	1.0	dB
	$f_o=$ 1000 to 1218 MHz		0.4	1.0	dB
Phase Balance	$f_o=$ 45 MHz, Nominal Phase Difference is 180°		2	3	$^{\circ}$
	$f_o=$ 45 to 300 MHz, Nominal Phase Difference is 180°		5	10	$^{\circ}$
	$f_o=$ 300 to 600 MHz, Nominal Phase Difference is 180°		13	18	$^{\circ}$
	$f_o=$ 600 to 1000 MHz, Nominal Phase Difference is 180°		20	26	$^{\circ}$
	$f_o=$ 1000 to 1218 MHz, Nominal Phase Difference is 180°		21	26	$^{\circ}$
DC Current Capability (in CT)				500	mA
Impedance Ratio			1:2.78		
Type - Transmission Line		Balanced to Balanced			

Typical Performance: T=25°C unless otherwise noted

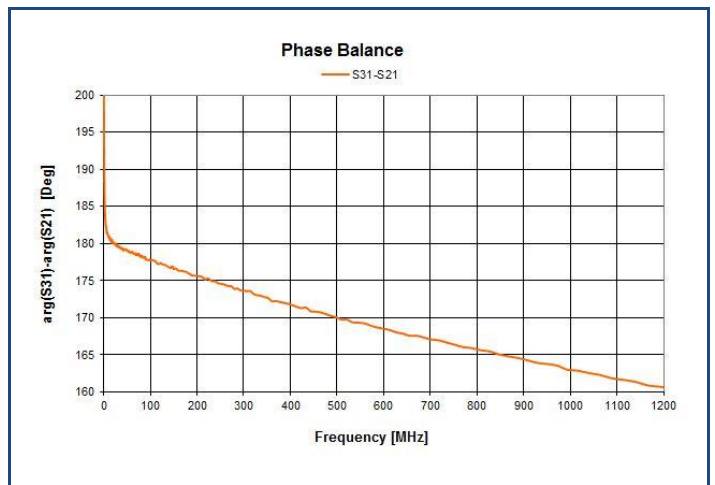
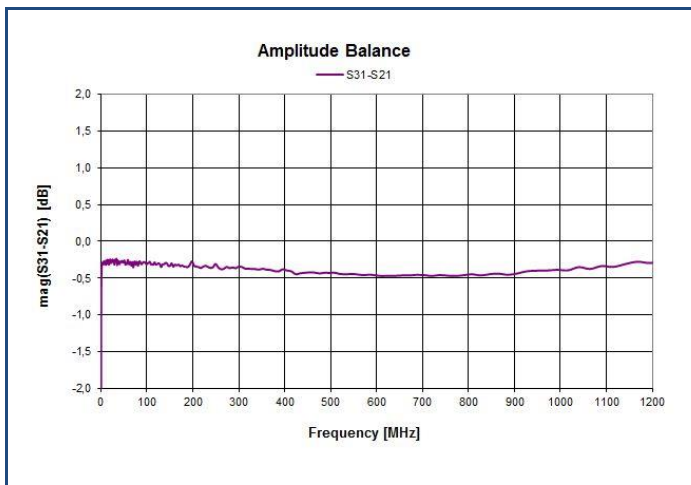
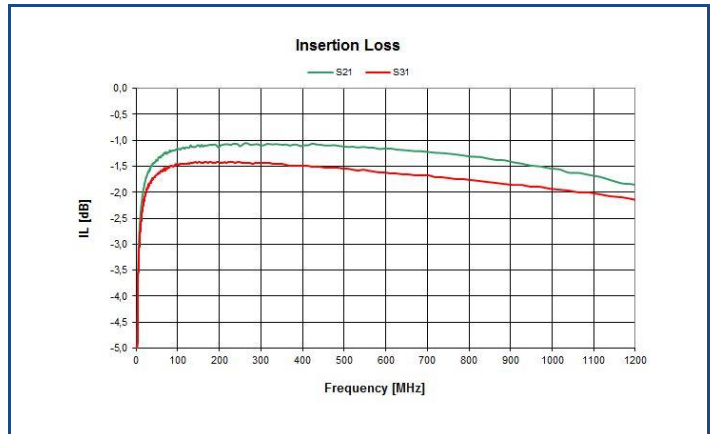

Package Outline, Pin Out and Branding Drawing (Dimensions in inches [mm])

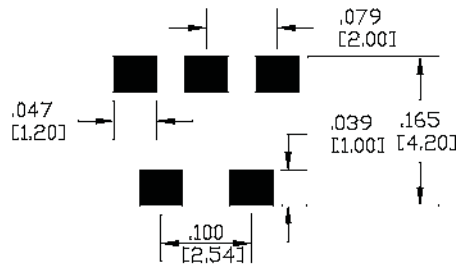
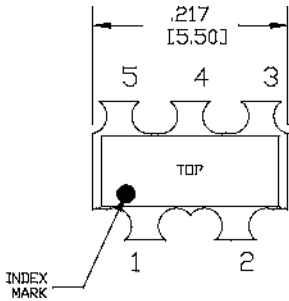

PCB FOOTPRINT

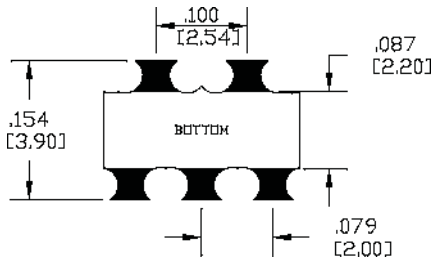
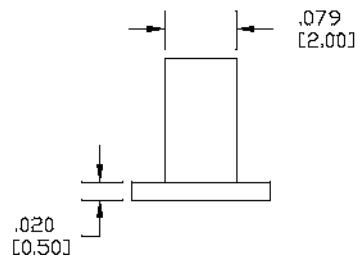
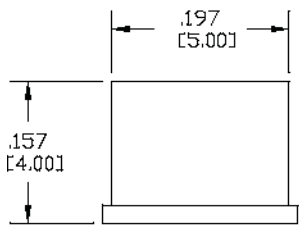

Handling Precautions

Parameter	Rating	Standard
ESD – Human Body Model (HBM)	N.A.	MIL-STD-1686



RoHS Compliance

This part is compliant with 2011/65/EU RoHS directive (Restrictions on the Use of Certain Hazardous Substances in Electrical and Electronic Equipment) as amended by Directive 2015/863/EU.

Contact Information

For the latest specifications, additional product information, worldwide sales and distribution locations:

Web: www.qorvo.com

Tel: 1-844-890-8163

Email: customer.support@qorvo.com

Important Notice

The information contained herein is believed to be reliable; however, Qorvo makes no warranties regarding the information contained herein and assumes no responsibility or liability whatsoever for the use of the information contained herein. All information contained herein is subject to change without notice. Customers should obtain and verify the latest relevant information before placing orders for Qorvo products. The information contained herein or any use of such information does not grant, explicitly or implicitly, to any party any patent rights, licenses, or any other intellectual property rights, whether with regard to such information itself or anything described by such information. **THIS INFORMATION DOES NOT CONSTITUTE A WARRANTY WITH RESPECT TO THE PRODUCTS DESCRIBED HEREIN, AND QORVO HEREBY DISCLAIMS ANY AND ALL WARRANTIES WITH RESPECT TO SUCH PRODUCTS WHETHER EXPRESS OR IMPLIED BY LAW, COURSE OF DEALING, COURSE OF PERFORMANCE, USAGE OF TRADE OR OTHERWISE, INCLUDING THE IMPLIED WARRANTIES OF MERCHANTABILITY AND FITNESS FOR A PARTICULAR PURPOSE.**

Without limiting the generality of the foregoing, Qorvo products are not warranted or authorized for use as critical components in medical, life-saving, or life-sustaining applications, or other applications where a failure would reasonably be expected to cause severe personal injury or death.

Copyright 2017 © Qorvo, Inc. | Qorvo is a registered trademark of Qorvo, Inc.