

## PolySwitch™ Resettable Device Short Form Catalog

MAY 2005



For over 20 years, Raychem Circuit Protection, a unit of Tyco Electronics, has pioneered the technology behind PolySwitch™ PPTC (Polymeric Positive Temperature Coefficient) devices. The use of PPTC devices as a variable resistor in circuit protection applications was first pioneered by Raychem several decades ago. They were first used to help protect nickel-cadmium battery packs against excessive discharge and are still being used in that application today.

Raychem Circuit Protection PolySwitch devices are commonly called resettable devices to distinguish them from traditional one-shot fuses that work only once and then must be replaced—an expensive and inconvenient proposition. While the generic term for these devices is “resettable fuses”, technically they are not fuses but actually non-linear thermistors.

Designed for use in a wide range of electronic devices, these thermistor-type devices limit the flow of dangerously high current during fault conditions. But unlike traditional fuses that work one time and must be replaced, Raychem Circuit Protection’s PPTC devices reset after the fault is cleared and power to the circuit is removed. This reduces service and repair costs, resulting in improved customer satisfaction and reduced warranty costs.

To date, billions of PolySwitch products are used to help protect a wide range of electronic products in automotive, battery and portable electronics, computer and peripherals, consumer, industrial, and telecommunication markets. In addition, Raychem Circuit Protection continues to expand their circuit protection offerings with Telecom Fuses, ROV Radial-leaded Metal Oxide Varistors, SiBar™ Thyristor surge protectors, Raychem Gas Discharge Tubes for overvoltage protection, and most recently, Polymer electrostatic discharge (PESD) protection devices.

Raychem Circuit Protection is recognized as a leader for operational excellence and customer service. A dedicated direct engineering sales force, world-wide manufacturing and design centers, and local engineering support help them to think, manage and share globally, yet act locally, to meet customer needs. They are in compliance with globally recognized ISO9000 standards and certified to QS9000 standards.

The division is headquartered in Menlo Park, CA with manufacturing facilities in California (USA), China, and Japan, with sales offices worldwide.

**For the latest product information please visit us at:**

[www.circuitprotection.com](http://www.circuitprotection.com)  
[www.circuitprotection.com.hk](http://www.circuitprotection.com.hk) (Chinese)  
[www.raychem.co.jp/polyswitch](http://www.raychem.co.jp/polyswitch) (Japanese)

Americas: (800) 227-7040 or (650) 361-6900  
Europe: 32-16-35 1321  
Asia Pacific: 852-2738-3401  
Japan: 81-44-900-5110

### **PolySwitch Resettable Device**

#### **Benefits:**

- Reduced warranty and service costs
- Increased reliability
- Superior shock and vibration withstand
- Wide variety of applications

#### **Features:**

- Remotely resettable
- Testable
- Solid-state
- Variety of form factors
- Low resistance devices available

### **PolySwitch devices can be used in a wide variety of applications:**

#### **Automotive**

- Actuators and medium motors
- Trace protection
- Powered outputs
- Electronic control modules
- Telematics

#### **Battery Protection**

- Lithium cells and battery packs
- Rechargeable battery packs
- Chargers

#### **Computers and Peripherals**

- DDC.2 computer video ports
- Hard disk drives/storage devices
- IEEE 1394 ports
- Mouse and keyboard ports
- USB (Universal Serial Bus) ports
- PC (PCMCIA) cards and sockets
- SCSI

#### **Industrial**

- MOSFET device protection
- Motors, fans, and blowers
- POS equipment
- Process and industrial controls
- Security and fire alarm systems
- Test and measurement equipment
- Transformers
- Power supplies

#### **Consumer**

- Loudspeakers
- Satellite video receivers

#### **Telecommunications & Networking**

- Central office equipment
- Customer premise equipment
- Primary protection: MDF modules, Network Interface Devices (NIDs)
- xDSL modems and ISDN equipment
- WAN, LAN, T1/E1 equipment
- Cable power passing taps
- UL 60950, Telcordia GR-1089, GR-974 compliant equipment
- Equipment compliant with ITU-T K.20, K.21, K.45 resistibility recommendations
- Distributed power supplies

#### **What's New Inside:**

- Radial-leaded Products
  - RoHS compliant RHE
- Surface-mount Products
  - RoHS compliant nanoSMD
  - RoHS compliant microSMD
  - RoHS compliant miniSMD
  - RoHS compliant decaSMD
  - RoHS compliant SMDH
- Automotive Products
  - RoHS compliant AHR
- Telecom Products
  - RoHS compliant TR600
  - RoHS compliant TS600
  - RoHS compliant TSM600

The AGRF, AHRF, AHS and ASMD series devices are qualified to operate in automotive environments per the AEC-Q200 Stress Test Qualification for Passive Electronics in automotive applications. This specification requires devices to pass a rigorous test plan designed for automotive environments. Raychem Circuit Protection's document is PS400.

Figure 1

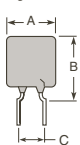

Lead size  
AGRF400-1100, AHRF450-1000  
Ø 0.81 (0.032)  
20 AWG

Lead size  
AGRF1200-1400, AHRF1300-1500  
Ø 1.0 (0.04)  
18 AWG

Figure 2

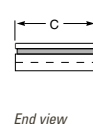
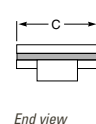
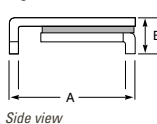

**AGRF: Radial-leaded**

**ELV Compliant, RoHS Compliant**

Part number	I <sub>H</sub> * (A) R <sub>1</sub> max.	I <sub>H</sub> * (A) R <sub>2</sub> max.	I <sub>T</sub> (A)	V max. (Vdc)	I max. (A)	R min. (Ω)	R <sub>1</sub> max. (Ω)	R <sub>2</sub> max. (Ω)	Dimensions (millimeters/inches)			Fig.
									A (max.)	B (max.)	C (typ.)	
AGRF400	4.0	3.0	7.6	16	100	0.0186	0.0610	0.0850	8.90 (0.35)	14.1 (0.56)	5.08 (0.20)	1
AGRF500	5.0	4.3	9.4	16	100	0.0140	0.0340	0.0480	10.40 (0.41)	15.6 (0.61)	5.08 (0.20)	1
AGRF600	6.0	5.3	10.7	16	100	0.0095	0.0280	0.0320	10.70 (0.42)	18.4 (0.73)	5.08 (0.20)	1
AGRF700	7.0	6.5	13.2	16	100	0.0066	0.0200	0.0220	11.20 (0.44)	21.0 (0.83)	5.08 (0.20)	1
AGRF800	8.0	7.6	15.0	16	100	0.0049	0.0175	0.0181	12.70 (0.50)	22.2 (0.88)	5.08 (0.20)	1
AGRF900	9.0	8.6	16.5	16	100	0.0041	0.0135	0.0140	14.00 (0.55)	23.0 (0.91)	5.08 (0.20)	1
AGRF1000	10.0	9.6	18.5	16	100	0.0034	0.0102	0.0106	16.51 (0.65)	25.7 (1.01)	5.08 (0.20)	1
AGRF1100	11.0	10.5	20.3	16	100	0.0033	0.0089	0.0093	17.50 (0.69)	26.5 (1.04)	5.08 (0.20)	1
AGRF1200	12.0	11.5	22.1	16	100	0.0030	0.0086	0.0091	17.50 (0.69)	28.8 (1.14)	10.90 (0.43)	1
AGRF1400	14.0	13.0	27.3	16	100	0.0022	0.0064	0.0067	23.50 (0.93)	28.7 (1.13)	10.90 (0.43)	1

\* Hold current @ 25°C.

**AHRF: High Temp Radial-leaded**

**ELV Compliant, RoHS Compliant**

Part number	I <sub>H</sub> * (A) R <sub>1</sub> max.	I <sub>H</sub> * (A) R <sub>2</sub> max.	I <sub>T</sub> (A)	V max. (Vdc)	I max. (A)	R min. (Ω)	R <sub>1</sub> max. (Ω)	R <sub>2</sub> max. (Ω)	Dimensions (millimeters/inches)			Fig.
									A (max.)	B (max.)	C (typ.)	
AHRF450	4.5	4.5	8.7	16	100	0.0170	0.054	0.054	10.4 (0.41)	15.6 (0.61)	5.08 (0.20)	1
AHRF600	6.0	6.0	12.0	16	100	0.0100	0.032	0.032	11.2 (0.44)	21.0 (0.83)	5.08 (0.20)	1
AHRF650	6.5	6.5	13.7	16	100	0.0090	0.026	0.026	12.7 (0.50)	22.2 (0.88)	5.08 (0.20)	1
AHRF750	7.5	7.5	14.8	16	100	0.0074	0.022	0.022	14.0 (0.55)	23.5 (0.93)	5.08 (0.20)	1
New AHRF900	9.0	9.0	18.5	16	100	0.0061	0.012	0.0170	16.5 (0.65)	25.7 (1.01)	5.08 (0.20)	1
AHRF1000	10.0	10.0	20.5	16	100	0.0051	0.015	0.015	17.5 (0.69)	26.5 (1.04)	10.90 (0.43)	1
AHRF1300	13.0	13.0	27.0	16	100	0.0034	0.010	0.010	23.5 (0.93)	28.7 (1.13)	10.90 (0.43)	1
New AHRF1500	15.0	15.0	33.0	16	100	0.0027	0.0063	0.0092	23.5 (0.93)	28.7 (1.13)	10.90 (0.43)	1

\* Hold current @ 25°C.

**AHS: High Temp Surface-mount**

**ELV Compliant, RoHS Compliant**

Part number	I <sub>H</sub> (A) R <sub>1</sub> max.	I <sub>H</sub> (A) R <sub>2</sub> max.	I <sub>T</sub> (A)	V max. (Vdc)	I max. (A)	R min. (Ω)	R <sub>1</sub> max. (Ω)	R <sub>2</sub> max. (Ω)	Dimensions (millimeters/inches)			Fig.
									A (max.)	B (max.)	C (typ.)	
AHS080-2018	0.80	0.80	2.00	16	70	0.130	0.550	0.550	5.44 (0.214)	1.52 (0.060)	4.93 (0.194)	2
AHS160	1.60	1.60	3.20	16	70	0.050	0.150	0.150	9.40 (0.370)	3.00 (0.118)	6.71 (0.264)	2

**ASMD: Surface-mount**

**ELV Compliant**

Part number	I <sub>H</sub> (A) R <sub>1</sub> max.	I <sub>H</sub> (A) R <sub>2</sub> max.	I <sub>T</sub> (A)	V max. (Vdc)	I max. (A)	R min. (Ω)	R <sub>1</sub> max. (Ω)	R <sub>2</sub> max. (Ω)	Dimensions (millimeters/inches)			Fig.
									A (max.)	B (max.)	C (max.)	
ASMD030	0.23	0.23	0.59	60	10	0.980	4.800	4.800	7.98 (0.314)	3.18 (0.125)	5.44 (0.214)	2
ASMD050	0.39	0.39	0.98	60	10	0.290	1.400	1.400	7.98 (0.314)	3.18 (0.125)	5.44 (0.214)	2
ASMD075	0.60	0.60	1.48	30	40	0.290	1.000	1.000	7.98 (0.314)	3.18 (0.125)	5.44 (0.214)	2
ASMD100	0.900	0.90	2.16	30	40	0.098	0.480	0.480	7.98 (0.314)	3.00 (0.118)	5.44 (0.214)	2
ASMD125	1.040	1.04	2.46	15	40	0.057	0.250	0.250	7.98 (0.314)	3.00 (0.118)	5.44 (0.214)	2
ASMD150	1.270	1.27	2.95	15	40	0.049	0.250	0.250	9.40 (0.370)	3.00 (0.118)	6.71 (0.264)	2
ASMD200	1.730	1.73	3.93	15	40	0.050	0.120	0.120	9.40 (0.370)	3.00 (0.118)	6.71 (0.264)	2
ASMD250	1.970	1.97	5.00	15	40	0.035	0.085	0.085	9.40 (0.370)	3.00 (0.118)	6.71 (0.264)	2

### 240V ELV Compliant, RoHS Compliant

The LVR series is the first PolySwitch device family designed for use at line voltages of 120V<sub>AC</sub> to 240V<sub>AC</sub>. They may be used to help provide primary side protection of chargers, power supplies, and control transformers in many industrial, commercial and consumer applications. They are also appropriate to help protect many 120V<sub>AC</sub> or 240V<sub>AC</sub> motors. In addition, the LVR series is RoHS compliant.

Figure 1

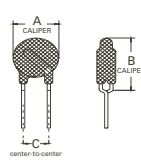
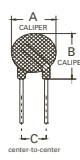

Figure 2



Lead size  
LVR005-016  
Ø 0.51 (0.020)  
24 AWG

Figure 3

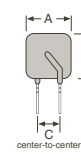
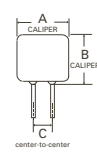

Figure 4



Lead size  
LVR025-040  
Ø 0.64 (0.025)  
22 AWG  
  
LVR055  
Ø 0.81 (0.032)  
20 AWG

#### Dimensions (millimeters/inches)

Part number	I <sub>H</sub> (A)	I <sub>T</sub> (A)	V max. (Vac)	I max.		Agency recognition	Dimensions (millimeters/inches)			Fig.
				135Vac/240Vac (A)	R <sub>1</sub> max. (Ω)		A (max.)	B (max.)	C (nom.)	
LVR005K	0.05	0.12	240	20/1.0	65.0	UL, TÜV, CSA	8.3 (0.33)	12.9 (0.51)	5.08 (0.20)	1
LVR005S	0.05	0.12	240	20/1.0	65.0	UL, TÜV, CSA	8.3 (0.33)	10.7 (0.43)	5.08 (0.20)	2
LVR008K	0.08	0.19	240	20/1.2	26.0	UL, TÜV, CSA	8.3 (0.33)	12.9 (0.51)	5.08 (0.20)	1
LVR008S	0.08	0.19	240	20/1.2	26.0	UL, TÜV, CSA	8.3 (0.33)	10.7 (0.43)	5.08 (0.20)	2
LVR012K	0.12	0.30	240	20/1.2	12.0	UL, TÜV, CSA	8.3 (0.33)	12.9 (0.51)	5.08 (0.20)	1
LVR012S	0.12	0.30	240	20/1.2	12.0	UL, TÜV, CSA	8.3 (0.33)	10.7 (0.43)	5.08 (0.20)	2
LVR016K	0.16	0.37	240	20/2.0	7.8	UL, TÜV, CSA	9.9 (0.39)	13.8 (0.54)	5.08 (0.20)	1
LVR016S	0.16	0.37	240	20/2.0	7.8	UL, TÜV, CSA	9.9 (0.39)	12.5 (0.50)	5.08 (0.20)	1
LVR025K	0.25	0.56	240	20/3.5	3.8	UL, TÜV, CSA	9.6 (0.38)	18.8 (0.74)	5.08 (0.20)	3
LVR025S	0.25	0.56	240	20/3.5	3.8	UL, TÜV, CSA	9.6 (0.38)	17.4 (0.69)	5.08 (0.20)	4
LVR033K	0.33	0.74	240	20/4.5	1.24	UL, TÜV, CSA	11.4 (0.45)	19.0 (0.75)	5.08 (0.20)	3
LVR033S	0.33	0.74	240	20/4.5	1.24	UL, TÜV, CSA	11.4 (0.45)	16.5 (0.65)	5.08 (0.20)	4
LVR040K	0.40	0.90	240	20/5.5	1.9	UL, TÜV, CSA	11.5 (0.46)	20.9 (0.82)	5.08 (0.20)	3
LVR040S	0.40	0.90	240	20/5.5	1.9	UL, TÜV, CSA	11.5 (0.46)	19.5 (0.77)	5.08 (0.20)	4
LVR055K	0.55	1.25	240	20/5.5	1.45	UL, TÜV, CSA	14.0 (0.55)	21.7 (0.85)	5.08 (0.20)	3
LVR055S	0.55	1.25	240	20/5.5	1.45	UL, TÜV, CSA	14.0 (0.55)	21.7 (0.85)	5.08 (0.20)	4

### 60V – 72V ELV Compliant, RoHS Compliant

The RXEF series devices offer hold currents ranging from 50mA to 3.75A while offering voltage ratings of 60V to 72V. The RXEF products are used in a wide range of applications such as power input, and I/O port protection. They are also used in many markets including computer/multimedia, industrial equipment and controls, consumer, general electronics and communications and networking.

Figure 5

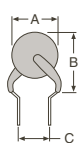

Lead size  
RXEF005  
Ø 0.40 (0.016)  
26 AWG

Figure 6

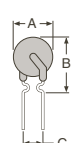

Lead size  
RXEF010-090  
Ø 0.51 (0.020)  
24 AWG

Figure 7

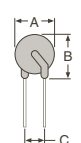

Lead size  
RXEF110-375  
Ø 0.81 (0.032)  
20 AWG

#### Dimensions (millimeters/inches)

Part number	I <sub>H</sub> (A)	I <sub>T</sub> (A)	V max. (V)	I max.** (A)	R <sub>1</sub> max. (Ω)	Agency recognition	Dimensions (millimeters/inches)			Fig.
							A (max.)	B (max.)	C (nom.)	
RXEF005	0.05	0.10	60	40	20.00	UL, TÜV, CSA	8.0 (0.32)	8.3 (0.33)	5.08 (0.20)	5
RXEF010	0.10	0.20	60	40	7.50	UL, TÜV, CSA	7.4 (0.29)	11.6 (0.46)	5.08 (0.20)	6
RXEF017	0.17	0.34	60	40	8.00	UL, TÜV, CSA	7.4 (0.29)	12.7 (0.50)	5.08 (0.20)	6
RXEF020	0.20	0.40	72	40	4.40	UL, TÜV, CSA	7.4 (0.29)	11.7 (0.46)	5.08 (0.20)	6
RXEF025	0.25	0.50	72	40	3.00	UL, TÜV, CSA	7.4 (0.29)	12.7 (0.50)	5.08 (0.20)	6
RXEF030	0.30	0.60	72	40	2.10	UL, TÜV, CSA	7.4 (0.29)	12.7 (0.50)	5.08 (0.20)	6
RXEF040	0.40	0.80	72	40	1.29	UL, TÜV, CSA	7.6 (0.30)	13.5 (0.53)	5.08 (0.20)	6
RXEF050	0.50	1.00	72	40	1.17	UL, TÜV, CSA	7.9 (0.31)	13.7 (0.54)	5.08 (0.20)	6
RXEF065	0.65	1.30	72	40	0.72	UL, TÜV, CSA	9.4 (0.37)	14.5 (0.57)	5.08 (0.20)	6
RXEF075	0.75	1.50	72	40	0.60	UL, TÜV, CSA	10.2 (0.40)	15.2 (0.60)	5.08 (0.20)	6
RXEF090	0.90	1.80	72	40	0.47	UL, TÜV, CSA	11.2 (0.44)	15.8 (0.62)	5.08 (0.20)	6
RXEF110	1.10	2.20	72	40	0.38	UL, TÜV, CSA	12.8 (0.50)	17.5 (0.69)	5.08 (0.20)	7
RXEF135	1.35	2.70	72	40	0.30	UL, TÜV, CSA	14.5 (0.57)	19.1 (0.75)	5.08 (0.20)	7
RXEF160	1.60	3.20	72	40	0.22	UL, TÜV, CSA	16.3 (0.64)	20.8 (0.82)	5.08 (0.20)	7
RXEF185	1.85	3.70	72	40	0.19	UL, TÜV, CSA	17.5 (0.69)	22.4 (0.88)	5.08 (0.20)	7
RXEF250	2.50	5.00	72	40	0.13	UL, TÜV, CSA	20.8 (0.82)	25.4 (1.00)	10.90 (0.43)	7
RXEF300	3.00	6.00	72	40	0.10	UL, TÜV, CSA	23.9 (0.94)	28.6 (1.13)	10.90 (0.43)	7
RXEF375	3.75	7.50	72	40	0.08	UL, TÜV, CSA	27.2 (1.07)	31.8 (1.25)	10.90 (0.43)	7

\*\* Device may withstand higher interrupt current at lower voltages. Each application will need to be individually evaluated.

**33V ELV Compliant, RoHS Compliant**

The RTEF series devices offer a 33V rating and tighter trip-to-hold ratios than other radial-leaded devices to help comply with the IEEE 1394 specification. These devices can also be used in other applications where the benefit of a tighter trip-to-hold ratio is desired.

Figure 8

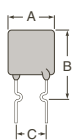

Lead size  
RTEF120-190  
Ø 0.51 (0.020)  
24 AWG

Part number	I <sub>H</sub> (A)	I <sub>T</sub> (A)	V max. (V)	I max.** (A)	R <sub>1</sub> max. (Ω)	Agency recognition	Dimensions (millimeters/inches)			Fig.
							A (max.)	B (max.)	C (nom.)	
RTEF120	1.20	2.3	33	40	0.180	UL, TÜV, CSA	7.4 (0.29)	12.2 (0.48)	5.08 (0.20)	8
RTEF135	1.35	2.5	33	40	0.143	UL, TÜV, CSA	7.4 (0.29)	14.2 (0.56)	5.08 (0.20)	8
RTEF190	1.90	3.0	33	40	0.092	UL, TÜV, CSA	8.9 (0.35)	13.5 (0.53)	5.08 (0.20)	8

\*\* Device may withstand higher interrupt current at lower voltages. Each application will need to be individually evaluated.

**30V ELV Compliant, RoHS Compliant**

The RUEF series devices offer hold currents from 900mA to 9.0A. They are used in many markets including computer/multimedia, industrial equipment and controls, as well as consumer and general electronics.

Figure 9

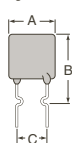

Lead size  
RUEF090-250  
Ø 0.51 (0.020)  
24 AWG

Figure 10

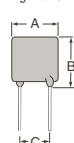

Lead size  
RUEF300-900  
Ø 0.81 (0.032)  
20 AWG

Part number	I <sub>H</sub> (A)	I <sub>T</sub> (A)	V max. (V)	I max.** (A)	R <sub>1</sub> max. (Ω)	Agency recognition	Dimensions (millimeters/inches)			Fig.
							A (max.)	B (max.)	C (nom.)	
RUEF090	0.90	1.8	30	40	0.22	UL, TÜV, CSA	7.4 (0.29)	12.2 (0.48)	5.08 (0.20)	9
RUEF110	1.10	2.2	30	40	0.17	UL, TÜV, CSA	7.4 (0.29)	14.2 (0.56)	5.08 (0.20)	9
RUEF135	1.35	2.7	30	40	0.13	UL, TÜV, CSA	8.9 (0.35)	13.5 (0.53)	5.08 (0.20)	9
RUEF160	1.60	3.2	30	40	0.11	UL, TÜV, CSA	8.9 (0.35)	15.2 (0.60)	5.08 (0.20)	9
RUEF185	1.85	3.7	30	40	0.09	UL, TÜV, CSA	10.2 (0.40)	15.7 (0.62)	5.08 (0.20)	9
RUEF250	2.50	5.0	30	40	0.07	UL, TÜV, CSA	11.4 (0.45)	18.3 (0.72)	5.08 (0.20)	9
RUEF300	3.00	6.0	30	40	0.08	UL, TÜV, CSA	11.4 (0.45)	17.3 (0.68)	5.08 (0.20)	10
RUEF400	4.00	8.0	30	40	0.05	UL, TÜV, CSA	14.0 (0.55)	20.1 (0.79)	5.08 (0.20)	10
RUEF500	5.00	10.0	30	40	0.05	UL, TÜV, CSA	14.0 (0.55)	24.9 (0.98)	10.90 (0.43)	10
RUEF600	6.00	12.0	30	40	0.04	UL, TÜV, CSA	16.5 (0.65)	24.9 (0.98)	10.90 (0.43)	10
RUEF700	7.00	14.0	30	40	0.03	UL, TÜV, CSA	19.1 (0.75)	26.7 (1.05)	10.90 (0.43)	10
RUEF800	8.00	16.0	30	40	0.02	UL, TÜV, CSA	21.6 (0.85)	29.2 (1.15)	10.90 (0.43)	10
RUEF900	9.00	18.0	30	40	0.02	UL, TÜV, CSA	24.1 (0.95)	29.7 (1.17)	10.90 (0.43)	10

\*\* Device may withstand higher interrupt current at lower voltages. Each application will need to be individually evaluated.



### 16V High Temperature

### ELV Compliant, RoHS Compliant

The RHEF series devices offer a high operating temperature (up to 125°C) and the broadest range of hold currents available in the radial-leaded form factor (70mA to 15A). The RHEF series devices can also be advantageous for use in standard operating temperatures of up to 85°C because they have a flatter thermal derating curve than other radial-leaded devices. Over the same temperature range, the trip-to-hold ratio is lower for an RHEF device compared with other PPTC devices.

Figure 11

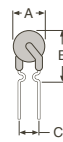

Lead size  
RHEF050, 100, 200  
Ø 0.51 (0.020)  
24 AWG

Figure 12

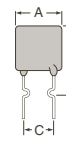

Lead size  
RHEF070  
Ø 0.51 (0.020)  
24 AWG

Figure 13

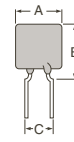

Lead size  
RHEF400-1000  
Ø 0.81 (0.032)  
20 AWG  
  
RHEF1300,  
RHEF1500  
Ø 1.0 (0.04)  
18 AWG

Part number	I <sub>H</sub> * (A)	I <sub>T</sub> (A)	V max. (Vdc)	I max.** (A)	R <sub>1</sub> max. (Ω)	Agency recognition	Dimensions (millimeters/inches)			Fig.
							A (max.)	B (max.)	C (nom.)	
<b>RHEF 30V</b>										
RHEF050	0.5	0.92	30	40	1.1	UL, TÜV, CSA	7.4 (0.29)	12.7 (0.50)	5.08 (0.20)	11
RHEF070	0.7	1.4	30	40	0.8	UL, TÜV, CSA	6.9 (0.27)	10.8 (0.43)	5.08 (0.20)	12
<b>New</b> RHEF100	1.0	1.8	30	40	0.43	UL, TÜV, CSA	9.7 (0.38)	13.6 (0.54)	5.08 (0.20)	11
<b>RHEF 16V</b>										
<b>New</b> RHEF200	2.0	3.8	16	100	0.110	UL, TÜV, CSA	9.40 (0.37)	14.4 (0.57)	5.08 (0.20)	11
RHEF400	4.0	7.0	16	100	0.044	UL, TÜV, CSA	11.40 (0.45)	18.0 (0.71)	5.08 (0.20)	13
<b>New</b> RHEF450	4.5	7.8	16	100	0.054	UL, TÜV, CSA	10.40 (0.41)	15.6 (0.61)	5.08 (0.20)	13
RHEF600	6.0	10.8	16	100	0.032	UL, TÜV, CSA	11.20 (0.44)	21.0 (0.83)	5.08 (0.20)	13
RHEF650	6.5	12.0	16	100	0.026	UL, TÜV, CSA	12.70 (0.50)	22.2 (0.88)	5.08 (0.20)	13
RHEF750	7.5	13.1	16	100	0.022	UL, TÜV, CSA	14.00 (0.55)	23.5 (0.93)	5.08 (0.20)	13
RHEF900	9.0	16.5	16	100	0.017	UL, TÜV, CSA	16.50 (0.65)	25.7 (1.01)	5.08 (0.20)	13
RHEF1000	10.0	18.5	16	100	0.015	UL, TÜV, CSA	17.50 (0.69)	26.5 (1.04)	10.90 (0.43)	13
<b>New</b> RHEF1300	13.0	24.0	16	100	0.010	UL, TÜV, CSA	23.50 (0.925)	28.7 (1.13)	10.90 (0.43)	13
RHEF1500	15.0	28.0	16	100	0.0092	UL, TÜV, CSA	23.50 (0.925)	28.7 (1.13)	10.90 (0.43)	13

\* Hold current @ 25°C.

\*\* Device may withstand higher interrupt current at lower voltages. Each application will need to be individually evaluated.

### 16V High Temperature

### ELV Compliant, RoHS Compliant

The RGEF series devices are rated for 16V and have hold current ranges of 2.5A to 14A. These parts are smaller and trip faster than the RUEF devices with the same hold currents. In addition, they have tight trip-to-hold ratios. If the application requires 16V rather than 30V and there are limitations on space, the RGEF devices can be the preferred choice. Like the RXEF and RUEF series devices, the RGEF devices are used in many markets including computer/multimedia, industrial equipment and controls, consumer and general electronics, as well as motor protection.

Figure 14

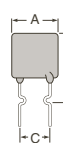

Lead size  
RGEF250  
Ø 0.51 (0.020)  
24 AWG

Figure 15

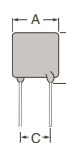

Lead size  
RGEF300-RGE1100  
Ø 0.81 (0.032)  
20 AWG  
  
RGEF1200-RGE1400  
Ø 1.0 (0.04)  
18 AWG

Part number	I <sub>H</sub> * (A)	I <sub>T</sub> (A)	V max. (Vdc)	I max.** (A)	R <sub>1</sub> max. (Ω)	Agency recognition	Dimensions (millimeters/inches)			Fig.
							A (max.)	B (max.)	C (nom.)	
RGEF250	2.5	4.7	16	100	0.0530	UL, TÜV, CSA	8.9 (0.35)	12.8 (0.50)	5.08 (0.20)	14
RGEF300	3.0	5.1	16	100	0.0980	UL, TÜV, CSA	7.1 (0.28)	11.0 (0.43)	5.08 (0.20)	15
RGEF400	4.0	6.8	16	100	0.0600	UL, TÜV, CSA	8.9 (0.35)	12.8 (0.50)	5.08 (0.20)	15
RGEF500	5.0	8.5	16	100	0.0340	UL, TÜV, CSA	10.4 (0.41)	14.3 (0.56)	5.08 (0.20)	15
RGEF600	6.0	10.2	16	100	0.0280	UL, TÜV, CSA	10.7 (0.42)	17.1 (0.67)	5.08 (0.20)	15
RGEF700	7.0	11.9	16	100	0.0220	UL, TÜV, CSA	11.2 (0.44)	19.7 (0.78)	5.08 (0.20)	15
RGEF800	8.0	13.6	16	100	0.0175	UL, TÜV, CSA	12.7 (0.50)	20.9 (0.82)	5.08 (0.20)	15
RGEF900	9.0	15.3	16	100	0.0135	UL, TÜV, CSA	14.0 (0.55)	21.7 (0.85)	5.08 (0.20)	15
RGEF1000	10.0	17.0	16	100	0.0102	UL, TÜV, CSA	16.5 (0.65)	25.2 (0.99)	5.08 (0.20)	15
RGEF1100	11.0	18.7	16	100	0.0089	UL, TÜV, CSA	17.5 (0.69)	26.0 (1.02)	5.08 (0.20)	15
RGEF1200	12.0	20.4	16	100	0.0086	UL, TÜV, CSA	17.5 (0.69)	28.0 (1.10)	10.90 (0.43)	15
RGEF1400	14.0	23.8	16	100	0.0064	UL, TÜV, CSA	23.5 (0.92)	27.9 (1.10)	10.90 (0.43)	15

\* Hold current @ 25°C.

\*\* Device may withstand higher interrupt current at lower voltages. Each application will need to be individually evaluated.

**16V High Temperature**

**ELV Compliant, RoHS Compliant**

The RUSBF series devices were developed for the USB serial bus specification in computer and multi-media applications.

Figure 16

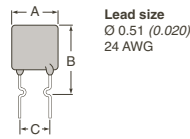

Part number	I <sub>H</sub> (A)	I <sub>T</sub> (A)	V max. (V)	I max.** (A)	R <sub>1</sub> max. (Ω)	Agency recognition	Dimensions (millimeters/inches)			Fig.
							A (max.)	B (max.)	C (nom.)	
RUSBF090	0.90	1.8	16	40	0.18	UL, TÜV, CSA	7.4 (0.29)	12.2 (0.48)	5.08 (0.20)	16
RUSBF110	1.10	2.2	16	40	0.14	UL, TÜV, CSA	7.4 (0.29)	14.2 (0.56)	5.08 (0.20)	16
RUSBF135	1.35	2.7	16	40	0.12	UL, TÜV, CSA	8.9 (0.35)	13.5 (0.53)	5.08 (0.20)	16
RUSBF160	1.60	3.2	16	40	0.11	UL, TÜV, CSA	8.9 (0.35)	15.2 (0.60)	5.08 (0.20)	16
RUSBF185	1.85	3.7	16	40	0.09	UL, TÜV, CSA	10.2 (0.40)	15.7 (0.62)	5.08 (0.20)	16
RUSBF250	2.50	5.0	16	40	0.06	UL, TÜV, CSA	11.4 (0.45)	18.3 (0.72)	5.08 (0.20)	16

\*\* Device may withstand higher interrupt current at lower voltages. Each application will need to be individually evaluated.

**6V**

**ELV Compliant, RoHS Compliant**

The RUSBF series devices were developed for the USB serial bus specification in computer and multi-media applications. These 6V products are particularly well suited for USB computer monitor protection applications where through-hole devices are still the preferred solution.

Figure 17

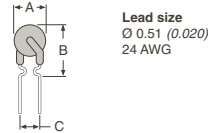

Part number	I <sub>H</sub> (A)	I <sub>T</sub> (A)	V max. (V)	I max.** (A)	R <sub>1</sub> max. (Ω)	Agency recognition	Dimensions (millimeters/inches)			Fig.
							A (max.)	B (max.)	C (nom.)	
RUSBF075	0.75	1.30	6	40	0.23	UL, TÜV, CSA	6.9 (0.27)	11.4 (0.45)	5.08 (0.20)	17
RUSBF120	1.20	2.00	6	40	0.14	UL, TÜV, CSA	6.9 (0.27)	11.7 (0.46)	5.08 (0.20)	17
RUSBF155	1.55	2.65	6	40	0.10	UL, TÜV, CSA	6.9 (0.27)	11.7 (0.46)	5.08 (0.20)	17

\*\* Device may withstand higher interrupt current at lower voltages. Each application will need to be individually evaluated.



These product lines consist of radial-leaded and surface-mount devices that help protect against short duration high voltage faults (250-600Vrms). TR and TS products are designed to help meet the protection needs of telecommunications applications. BBR devices help provide overcurrent protection of the power tap in hybrid-coaxial applications.

Figure 1

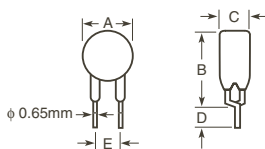
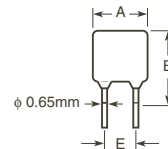

Figure 2



## TR250

Part number	I <sub>H</sub> (A)	I <sub>T</sub> (A)	V max. Operating (Vdc)	V max. Interrupt (Vrms)	I max. (A)	R min. (Ω)	R max. (Ω)	R <sub>1</sub> max. (Ω)	Agency recognition	Fig.
TR250-080T	0.080	0.160	60	250	3.0	15.0	22.0	33.0	UL, TÜV, CSA	1
TR250-080U	0.080	0.160	60	250	3.0	14.0	20.0	33.0	UL, TÜV, CSA	1
TR250-110U	0.110	0.220	60	250	3.0	5.0	9.0	16.0	UL, TÜV, CSA	1
TR250-120	0.120	0.240	60	250	3.0	4.0	8.0	16.0	UL, TÜV, CSA	2
TR250-120T	0.120	0.240	60	250	3.0	7.0	12.0	16.0	UL, TÜV, CSA	2
TR250-120T-RA	0.120	0.240	60	250	3.0	7.0	9.0	16.0	UL, TÜV, CSA	2
TR250-120T-RC	0.130	0.240	60	250	3.0	5.4	7.5	14.0	UL, TÜV, CSA	2
TR250-120T-RF	0.120	0.240	60	250	3.0	6.0	10.5	16.0	UL, TÜV, CSA	2
TR250-120T-R1	0.120	0.240	60	250	3.0	6.0	9.0	16.0	UL, TÜV, CSA	2
TR250-120T-R2	0.120	0.240	60	250	3.0	8.0	10.5	16.0	UL, TÜV, CSA	2
TR250-120U	0.120	0.240	60	250	3.0	6.0	10.0	16.0	UL, TÜV, CSA	2
TR250-120UT	0.120	0.240	60	250	3.0	7.0	12.0	16.0	UL, TÜV, CSA	2
TR250-145	0.145	0.290	60	250	3.0	3.0	6.0	14.0	UL, TÜV, CSA	2
TR250-145-RA	0.145	0.290	60	250	3.0	3.0	5.5	12.0	UL, TÜV, CSA	2
TR250-145-RB	0.145	0.290	60	250	3.0	4.5	6.0	14.0	UL, TÜV, CSA	2
TR250-145T	0.145	0.290	60	250	3.0	5.4	7.5	14.0	UL, TÜV, CSA	2
TR250-145U	0.145	0.290	60	250	3.0	3.5	6.5	12.0	UL, TÜV, CSA	2
TRF250-180†	0.180	0.650	100	250	10.0	0.8	2.2	4.0	UL, TÜV, CSA	1

These products are intended for telecom applications. For continuous line voltage applications, see LVR product line. Please see the Raychem Circuit Protection Databook for application details. Most products are available in binned versions for resistance-matched applications. Please see Raychem Circuit Protection Databook for performance details.

† F is for RoHS compliant devices.

Part number	Dimensions (millimeters/inches)					
	A (max.)	B (max.)	C (max.)	D (min.)	E (typ.)	Fig.
TR250-080T	5.8 (0.228)	9.9 (0.390)	4.6 (0.181)	4.7 (0.185)	5.0 (0.197)	1
TR250-080U	4.8 (0.189)	9.3 (0.366)	3.8 (0.150)	4.7 (0.185)	5.0 (0.197)	1
TR250-110U	5.3 (0.210)	9.4 (0.370)	3.8 (0.150)	4.7 (0.185)	5.0 (0.197)	1
TR250-120	6.5 (0.256)	11.0 (0.433)	4.6 (0.180)	4.7 (0.185)	5.0 (0.197)	2
TR250-120U	6.0 (0.236)	10.0 (0.394)	3.8 (0.150)	4.7 (0.185)	5.0 (0.197)	2
TR250-145	6.5 (0.256)	11.0 (0.433)	4.6 (0.180)	4.7 (0.185)	5.0 (0.197)	2
TR250-145U	6.0 (0.236)	10.0 (0.394)	3.8 (0.150)	4.7 (0.185)	5.0 (0.197)	2
TRF250-180	9.0 (0.354)	12.0 (0.472)	3.8 (0.150)	4.7 (0.185)	5.0 (0.197)	1

**TS250**

Figure 3

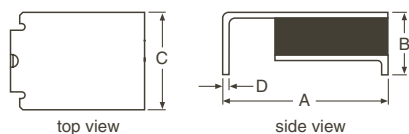

Figure 4

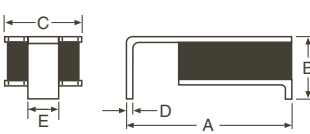
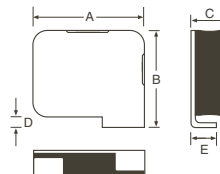

Figure 5



Part number	I <sub>H</sub> (A)	I <sub>T</sub> (A)	V max. Operating (Vdc)	V max. Interrupt (Vrms)	I max. (A)	R min. (Ω)	R max. (Ω)	R <sub>1</sub> max. (Ω)	Agency recognition	Fig.
TS250-130	0.130	0.260	60	250 (650)	3.0	6.5	12.0	20.0	UL, TÜV, CSA	3
TS250-130-RA	0.130	0.260	60	250 (650)	3.0	6.5	9.0	15.0	UL, TÜV, CSA	3
TS250-130-RB	0.130	0.260	60	250 (650)	3.0	9.0	12.0	20.0	UL, TÜV, CSA	3
TS250-130-RC	0.130	0.260	60	250 (650)	3.0	7.0	10.0	17.0	UL, TÜV, CSA	3
Coming Soon TS250-130F	0.130	0.260	60	250 (650)	3.0	6.5	12.0	20.0	UL, TÜV, CSA	3
Coming Soon TS250-130F-RA	0.130	0.260	60	250 (650)	3.0	6.5	9.0	15.0	UL, TÜV, CSA	3
Coming Soon TS250-130F-RB	0.130	0.260	60	250 (650)	3.0	9.0	12.0	20.0	UL, TÜV, CSA	3
Coming Soon TS250-130F-RC	0.130	0.260	60	250 (650)	3.0	7.0	10.0	17.0	UL, TÜV, CSA	3
TSL250-080	0.080	0.160	80	250	3.0	5.0	11.0	20.0	UL, TÜV, CSA	4
Coming Soon TSL250-080F	0.080	0.160	80	250	3.0	5.0	11.0	20.0	UL, TÜV, CSA	4
TSV250-130	0.130	0.260	60	250	3.0	4.0	7.0	12.0	UL, TÜV, CSA	5
Coming Soon TSV250-130F	0.130	0.260	60	250	3.0	4.0	7.0	12.0	UL, TÜV, CSA	5

These products are intended for telecom applications. For continuous line voltage applications, see LVR product line. Please see the Raychem Circuit Protection Databook for application details. Most products are available in binned versions for resistance-matched applications. Please see Raychem Circuit Protection Databook for performance details.

**Dimensions (millimeters/inches)**

Part number	A (max.)	B (max.)	C (max.)	D (typ.)	Fig.
TS250-130	9.4 (0.370)	3.4 (0.135)	7.4 (0.290)	0.3 (0.011)	3
TS250-130-RA	9.4 (0.370)	3.4 (0.135)	7.4 (0.290)	0.3 (0.011)	3
TS250-130-RB	9.4 (0.370)	3.4 (0.135)	7.4 (0.290)	0.3 (0.011)	3
TS250-130-RC	9.4 (0.370)	3.4 (0.135)	7.4 (0.290)	0.3 (0.011)	3
Coming Soon TS250-130F	9.4 (0.370)	3.4 (0.135)	7.4 (0.290)	0.3 (0.011)	3
Coming Soon TS250-130F-RA	9.4 (0.370)	3.4 (0.135)	7.4 (0.290)	0.3 (0.011)	3
Coming Soon TS250-130F-RB	9.4 (0.370)	3.4 (0.135)	7.4 (0.290)	0.3 (0.011)	3
Coming Soon TS250-130F-RC	9.4 (0.370)	3.4 (0.135)	7.4 (0.290)	0.3 (0.011)	3

**Dimensions (millimeters/inches)**

Part number	A (max.)	B (max.)	C (max.)	D (max.)	E (max.)	Fig.
TSL250-080	7.9 (0.310)	3.7 (0.145)	5.3 (0.210)	0.4 (0.015)	3.1 (0.120)	4
Coming Soon TSL250-080F	7.9 (0.310)	3.7 (0.145)	5.3 (0.210)	0.4 (0.015)	3.1 (0.120)	4
TSV250-130	6.1 (0.240)	6.9 (0.270)	3.0 (0.126)	1.9 (0.075)	2.3 (0.091)	5
Coming Soon TSV250-130F	6.1 (0.240)	6.9 (0.270)	3.0 (0.126)	1.9 (0.075)	2.3 (0.091)	5

**TR600**

Figure 6

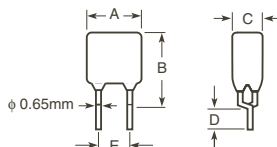

Part number	I <sub>H</sub> (A)	I <sub>T</sub> (A)	V max. Operating (Vdc)	V max. Interrupt (Vrms)	I max. (A)	R min. (Ω)	R max. (Ω)	R <sub>1</sub> max. (Ω)	Agency recognition	Fig.
TRF600-150*	0.150	0.300	250	600	3.0	6.0	10.0	17.0	Pending	6
New TRF600-150-RB*	0.130	0.260	250	600	3.0	9.0	12.0	20.0	UL, CSA	6
TR600-160	0.160	0.320	250	600	3.0	4.0	10.0	18.0	UL, CSA	6
TR600-160-RA	0.160	0.320	250	600	3.0	4.0	7.0	16.0	UL, CSA	6
TR600-160-R1	0.160	0.320	250	600	3.0	4.0	8.0	17.0	UL, CSA	6

These products are intended for telecom applications. For continuous line voltage applications, see LVR product line. Please see the Raychem Circuit Protection Databook for application details. Most products are available in binned versions for resistance-matched applications. Please see Raychem Circuit Protection Databook for performance details.

\* These parts are RoHS compliant. TRF600-150 replaces TR600-150 and TR600-150-RA devices in new designs. TRF600-150-RB replaces TR600-150-RB devices in new designs.

**Dimensions (millimeters/inches)**

Part number	A (max.)	B (max.)	C (max.)	D (min.)	E (max.)	Fig.
TRF600-150*	9.0 (0.354)	12.5 (0.492)	4.6 (0.180)	4.7 (0.185)	5.0 (0.197)	6
TR600-160	16.0 (0.630)	12.6 (0.496)	6.0 (0.236)	4.7 (0.185)	5.0 (0.197)	6

\* This part is RoHS compliant and replaces TR600-150 and TR600-150-RA devices in new designs.

## TS600

Figure 7

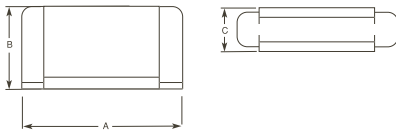
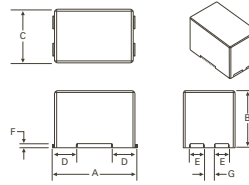

Figure 8



Part number	I <sub>H</sub> (A)	I <sub>T</sub> (A)	V max. Operating (Vdc)	V max. Interrupt (Vrms)	I max. (A)	R min. (Ω)	R max. (Ω)	R <sub>1</sub> max. (Ω)	Agency recognition	Fig.
TS600-170	0.170	0.400	60	600	3.0	4.0	9.0	18.0	UL, CSA	7
TS600-200-RA-B-0.5	0.200	0.400	60	600	3.0	4.0	7.5	13.5	UL, CSA	7
<b>New</b> TS600-170F*	0.170	0.400	60	600	3.0	4.0	9.0	18.0	UL, CSA	7
<b>New</b> TS600-200F-RA-B-0.5*	0.200	0.400	60	600	3.0	4.0	7.5	13.5	UL, CSA	7
TSM600-250	0.250	0.860	250	600	3.0	1.0	3.5 (typ.)	7.0	UL, CSA	8
TSM600-250-RA	0.250	0.860	250	600	3.0	1.0	3.0 (typ.)	5.0	UL, CSA	8
<b>New</b> TSM600-250F*	0.250	0.860	250	600	3.0	1.0	3.5 (typ.)	7.0	UL, CSA	8
<b>New</b> TSM600-250F-RA*	0.250	0.860	250	600	3.0	1.0	3.0 (typ.)	5.0	UL, CSA	8

These products are intended for telecom applications. For continuous line voltage applications, see LVR product line. Please see the Raychem Circuit Protection Databook for application details.

\* These parts are the RoHS compliant versions; they should be used for new designs.

### Dimensions (millimeters/inches)

Part number	A (max.)	B (max.)	C (max.)	Fig.
TS600-170	19.4 (0.765)	12.3 (0.485)	8.3 (0.325)	7
TS600-200-RA-B-0.5	19.4 (0.765)	12.3 (0.485)	8.3 (0.325)	7
<b>New</b> TS600-170F*	19.4 (0.765)	12.3 (0.485)	8.3 (0.325)	7
<b>New</b> TS600-200F-RA-B-0.5*	19.4 (0.765)	12.3 (0.485)	8.3 (0.325)	7

\* These parts are the RoHS compliant versions; they should be used for new designs.

### Dimensions (millimeters/inches)

Part number	A (max.)	B (max.)	C (max.)	D (max.)	E (max.)	F (max.)	G (min.)	Fig.
TSM600-250	17.6 (0.691)	11.7 (0.460)	11.2 (0.440)	5.2 (0.230)	2.8 (0.111)	1.0 (0.038)	2.0 (0.080)	8
TSM600-250-RA	17.6 (0.691)	11.7 (0.460)	11.2 (0.440)	5.2 (0.230)	2.8 (0.111)	1.0 (0.038)	2.0 (0.080)	8
<b>New</b> TSM600-250F*	17.6 (0.691)	11.7 (0.460)	11.2 (0.440)	5.2 (0.230)	2.8 (0.111)	1.0 (0.038)	2.0 (0.080)	8
<b>New</b> TSM600-250F-RA*	17.6 (0.691)	11.7 (0.460)	11.2 (0.440)	5.2 (0.230)	2.8 (0.111)	1.0 (0.038)	2.0 (0.080)	8

## BBR

Figure 9

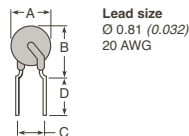

Part number	I <sub>H</sub> (A)	I <sub>T</sub> (A)	V max. (Vdc)	I max. (A)	R min. (Ω)	R max. (Ω)	R <sub>1</sub> max. (Ω)	Agency recognition	Fig.
BBR550	0.55	1.1	99	20	0.80	1.30	1.95	UL, CSA	9
BBR750	0.75	1.5	99	20	0.40	0.75	1.20	UL, CSA	9

These products are intended for telecom applications. For continuous line voltage applications, see LVR product line. Please see the Raychem Circuit Protection Databook for application details.

### Dimensions (millimeters/inches)

Part number	A (max.)	B (max.)	C (nom.)	D (min.)	Fig.
BBR550	10.9 (0.43)	14.0 (0.55)	5.80 (0.23)	7.6 (0.3)	9
BBR750	11.9 (0.47)	15.5 (0.61)	5.80 (0.23)	7.6 (0.3)	9

These product lines are designed for surface-mount applications. The variety of sizes enables installation in limited space applications such as crowded printed circuit boards, digital cameras, PC cards, subnotebook computers, computer peripheral equipment, and general electronics. These devices are designed for applications where such space is constrained and resettable circuit protection is desired.

Figure 1

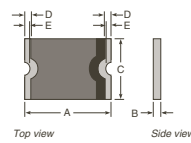

**nanoSMDC Series Size: 3216 (mm), 1206 (mils) ELV Compliant, RoHS Compliant**

Part number	I <sub>H</sub> (A)	I <sub>T</sub> (A)	V max. (Vdc)	I max. (A)	R <sub>min</sub> (Ω)	R <sub>1</sub> max. (Ω)	Agency recognition	Dimensions (millimeters/inches)					Fig.
								A (max.)	B (max.)	C (max.)	D (min.)	E (min.)	
Coming Soon nanoSMDC012F*	0.12	0.30	30	10	1.40	6.50	Pending	3.4 (0.134)	1.00 (0.039)	1.8 (0.071)	0.25 (0.010)	0.076 (0.003)	1
Coming Soon nanoSMDC016F*	0.16	0.40	30	10	1.10	5.00	Pending	3.4 (0.134)	1.00 (0.039)	1.8 (0.071)	0.25 (0.010)	0.076 (0.003)	1
nanoSMDC020F	0.20	0.42	24	100	0.65	2.60	UL, TÜV, CSA	3.4 (0.134)	0.64 (0.025)	1.8 (0.071)	0.25 (0.010)	0.076 (0.003)	1
nanoSMDC035F	0.35	0.75	16	20	0.45	1.40	UL, TÜV, CSA	3.4 (0.134)	0.64 (0.025)	1.8 (0.071)	0.25 (0.010)	0.076 (0.003)	1
nanoSMDC050F/13.2	0.50	1.10	13.2	100	0.20	0.80	UL, TÜV, CSA	3.4 (0.134)	0.64 (0.025)	1.8 (0.071)	0.25 (0.010)	0.076 (0.003)	1
nanoSMDC075F	0.75	1.50	6	100	0.12	0.40	UL, TÜV, CSA	3.4 (0.134)	0.48 (0.019)	1.8 (0.071)	0.25 (0.010)	0.076 (0.003)	1
nanoSMDC110F	1.10	2.20	6	100	0.07	0.20	UL, TÜV, CSA	3.4 (0.134)	1.00 (0.039)	1.8 (0.071)	0.25 (0.010)	0.076 (0.003)	1
nanoSMDC150F	1.50	3.00	6	100	0.04	0.11	UL, TÜV, CSA	3.4 (0.134)	0.89 (0.035)	1.8 (0.071)	0.25 (0.010)	0.076 (0.003)	1
Coming Soon nanoSMDC200F*	2.00	4.00	6	100	0.02	0.07	Pending	3.4 (0.134)	1.25 (0.049)	1.8 (0.071)	0.25 (0.010)	0.076 (0.003)	1

\* Data is preliminary.

**microSMD Series Size: 3225 (mm), 1210 (mils) ELV Compliant, RoHS Compliant**

Part number	I <sub>H</sub> (A)	I <sub>T</sub> (A)	V max. (Vdc)	I max. (A)	R <sub>min</sub> (Ω)	R <sub>1</sub> max. (Ω)	Agency recognition	Dimensions (millimeters/inches)					Fig.
								A (max.)	B (max.)	C (max.)	D (min.)	E (min.)	
microSMD005F	0.05	0.15	30	10	3.6	50.0	UL, TÜV, CSA	3.43 (0.135)	0.85 (0.034)	2.80 (0.110)	0.25 (0.010)	0.20 (0.008)	1
microSMD010F	0.10	0.25	30	10	2.10	15.00	UL, TÜV, CSA	3.43 (0.135)	0.85 (0.034)	2.80 (0.110)	0.25 (0.010)	0.20 (0.008)	1
microSMD035F	0.35	0.75	6	40	0.32	1.30	UL, TÜV, CSA	3.43 (0.135)	0.62 (0.025)	2.80 (0.110)	0.25 (0.010)	0.20 (0.008)	1
microSMD050F	0.50	1.00	13.2	40	0.25	0.90	UL, TÜV, CSA	3.43 (0.135)	0.62 (0.025)	2.80 (0.110)	0.25 (0.010)	0.20 (0.008)	1
microSMD075F	0.75	1.50	6	40	0.11	0.40	UL, TÜV, CSA	3.43 (0.135)	0.62 (0.025)	2.80 (0.110)	0.25 (0.010)	0.20 (0.008)	1
microSMD110F	1.10	2.20	6	40	0.07	0.21	UL, TÜV, CSA	3.43 (0.135)	0.48 (0.019)	2.80 (0.110)	0.25 (0.010)	0.20 (0.008)	1
microSMD150F	1.50	3.00	6	40	0.04	0.11	UL, TÜV, CSA	3.43 (0.135)	1.22 (0.048)	2.80 (0.110)	0.25 (0.010)	0.20 (0.008)	1
New microSMD175F	1.75	3.50	6	40	0.02	0.08	UL, TÜV, CSA	3.43 (0.135)	0.76 (0.030)	2.80 (0.110)	0.25 (0.010)	0.20 (0.008)	1

**miniSMDC Series Size: 4532 (mm), 1812 (mils) ELV Compliant, RoHS Compliant**

Part number	I <sub>H</sub> (A)	I <sub>T</sub> (A)	V max. (Vdc)	I max. (A)	R <sub>min</sub> (Ω)	R <sub>1</sub> max. (Ω)	Agency recognition	Dimensions (millimeters/inches)					Fig.
								A (max.)	B (max.)	C (max.)	D (min.)	E (min.)	
miniSMDC014F	0.14	0.34	60	10	1.500	6.000	UL, TÜV, CSA	4.73 (0.186)	0.89 (0.035)	3.41 (0.134)	0.25 (0.010)	0.20 (0.008)	1
miniSMDC020F	0.20	0.40	30	10	0.600	3.300	UL, TÜV, CSA	4.73 (0.186)	0.89 (0.035)	3.41 (0.134)	0.25 (0.010)	0.20 (0.008)	1
miniSMDC050F	0.50	1.00	24	100	0.150	1.000	UL, TÜV, CSA	4.73 (0.186)	0.62 (0.025)	3.41 (0.134)	0.25 (0.010)	0.20 (0.008)	1
miniSMDC075F	0.75	1.50	13.2	100	0.110	0.450	UL, TÜV, CSA	4.73 (0.186)	0.62 (0.025)	3.41 (0.134)	0.25 (0.010)	0.20 (0.008)	1
New miniSMDC075F/24	0.75	1.50	24	40	0.090	0.290	UL, TÜV, CSA	4.73 (0.186)	1.07 (0.042)	3.41 (0.134)	0.25 (0.010)	0.20 (0.008)	1
miniSMDC110F	1.10	2.20	8	100	0.040	0.210	UL, TÜV, CSA	4.73 (0.186)	0.62 (0.025)	3.41 (0.134)	0.25 (0.010)	0.20 (0.008)	1
miniSMDC110F/16	1.10	2.20	16	100	0.060	0.180	UL, TÜV, CSA	4.73 (0.186)	0.48 (0.019)	3.41 (0.134)	0.25 (0.010)	0.20 (0.008)	1
New miniSMDC110F/24	1.10	2.20	24	20	0.060	0.180	UL, TÜV, CSA	4.73 (0.186)	1.07 (0.042)	3.41 (0.134)	0.25 (0.010)	0.20 (0.008)	1
miniSMDC125F	1.25	2.50	6	100	0.050	0.140	UL, TÜV, CSA	4.73 (0.186)	0.48 (0.019)	3.41 (0.134)	0.25 (0.010)	0.20 (0.008)	1
miniSMDC125F/16	1.25	2.50	16	100	0.050	0.140	UL, TÜV, CSA	4.73 (0.186)	0.48 (0.019)	3.41 (0.134)	0.25 (0.010)	0.20 (0.008)	1
miniSMDC150F	1.50	3.00	6	100	0.040	0.110	UL, TÜV, CSA	4.73 (0.186)	0.48 (0.019)	3.41 (0.134)	0.25 (0.010)	0.20 (0.008)	1
New miniSMDC150F/12	1.50	3.00	12	100	0.040	0.110	UL, TÜV, CSA	4.73 (0.186)	0.48 (0.019)	3.41 (0.134)	0.25 (0.010)	0.20 (0.008)	1
New miniSMDC150F/24	1.50	3.00	24	20	0.040	0.120	UL, TÜV, CSA	4.73 (0.186)	1.50 (0.060)	3.41 (0.134)	0.25 (0.010)	0.20 (0.008)	1
miniSMDC160F	1.60	3.20	9	100	0.030	0.100	UL, TÜV, CSA	4.73 (0.186)	0.48 (0.019)	3.41 (0.134)	0.25 (0.010)	0.20 (0.008)	1
miniSMDC200F	2.00	4.00	8	100	0.020	0.070	UL, TÜV, CSA	4.73 (0.186)	1.22 (0.048)	3.41 (0.134)	0.25 (0.010)	0.20 (0.008)	1
miniSMDC260F	2.60	5.00	6	100	0.015	0.043	UL, TÜV, CSA	4.73 (0.186)	1.25 (0.050)	3.41 (0.134)	0.25 (0.010)	0.20 (0.008)	1
miniSMDC260F/12	2.60	5.00	12	100	0.015	0.047	UL, TÜV, CSA	4.73 (0.186)	1.25 (0.050)	3.41 (0.134)	0.25 (0.010)	0.20 (0.008)	1
Coming Soon miniSMDC260F/16*	2.60	5.00	16	100	0.015	0.047	Pending	4.73 (0.186)	1.25 (0.050)	3.41 (0.134)	0.25 (0.010)	0.20 (0.008)	1

\* Data is preliminary.

**miniSMDE Series Size: 11550 (mm), 4420 (mils) ELV Compliant, RoHS Compliant**

Part number	I <sub>H</sub> (A)	I <sub>T</sub> (A)	V max. (Vdc)	I max. (A)	R <sub>min</sub> (Ω)	R <sub>1</sub> max. (Ω)	Agency recognition	Dimensions (millimeters/inches)					Fig.
								A (max.)	B (max.)	C (max.)	D (min.)	E (min.)	
New miniSMDE190F	1.90	3.80	16	100	0.024	0.080	UL, TÜV, CSA	11.51 (0.453)	0.53 (0.021)	5.33 (0.210)	0.510 (0.020)	0.381 (0.015)	1

These product lines are also designed for surface-mount applications. The products range in hold currents from 0.3A to 3.0A and voltages from 6V to 60V. These devices are suited for high-density board applications in computer and computer peripheral products, telecommunications, and general electronics applications. They are designed to be reflowed onto a printed circuit board using standard surface-mount processes.

Figure 2

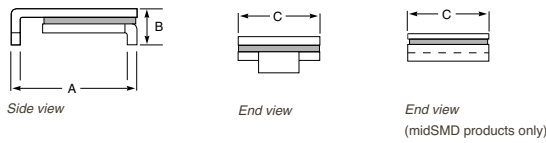

**midSMD Series Size: 5050 (mm), 2018 (mils)**

**ELV Compliant, RoHS Compliant**

Part number	I <sub>H</sub> (A)	I <sub>T</sub> (A)	V max. (Vdc)	I max. (A)	R <sub>min</sub> (Ω)	R <sub>1</sub> max. (Ω)	Agency recognition	Dimensions (millimeters/inches)					
								A (max.)	B (max.)	C (max.)	D (min.)	E (min.)	Fig.
SMD030F-2018	0.30	0.80	60	20	0.500	2.30	UL, TÜV, CSA	5.44 (0.214)	1.78 (0.070)	4.93 (0.194)			2
<b>New</b> decaSMD050F/60	0.55	1.10	60	10	0.40	1.10	UL, TÜV, CSA	5.31 (0.209)	0.89 (0.035)	4.80 (0.189)	0.25 (0.010)	0.20 (0.008)	1
SMD100F-2018	1.10	2.20	15	40	0.100	0.40	UL, TÜV, CSA	5.44 (0.214)	1.52 (0.060)	4.93 (0.194)			2
SMD150F-2018	1.50	3.00	15	40	0.070	0.18	UL, TÜV, CSA	5.44 (0.214)	1.52 (0.060)	4.93 (0.194)			2
SMD200F-2018	2.00	4.20	6	40	0.048	0.10	UL, TÜV, CSA	5.44 (0.214)	1.52 (0.060)	4.93 (0.194)			2

**SMD Series Size: 7555 (mm), 2920 (mils)**

**ELV Compliant, RoHS Compliant**

Part number	I <sub>H</sub> (A)	I <sub>T</sub> (A)	V max. (Vdc)	I max. (A)	R <sub>min</sub> (Ω)	R <sub>1</sub> max. (Ω)	Agency recognition	Dimensions (millimeters/inches)			
								A (max.)	B (max.)	C (max.)	Fig.
SMD030F	0.30	0.60	60	10	1.20	4.800	UL, TÜV, CSA	7.98 (0.314)	3.18 (0.125)	5.44 (0.214)	2
SMD050F	0.50	1.00	60	10	0.350	1.400	UL, TÜV, CSA	7.98 (0.314)	3.18 (0.125)	5.44 (0.214)	2
SMD075F	0.75	1.50	30	40	0.350	1.000	UL, TÜV, CSA	7.98 (0.314)	3.18 (0.125)	5.44 (0.214)	2
SMD075F/60	0.75	1.50	60	10	0.350	1.000	UL, TÜV, CSA	7.98 (0.314)	3.18 (0.125)	5.44 (0.214)	2
SMD100F	1.10	2.20	30	40	0.120	0.480	UL, TÜV, CSA	7.98 (0.314)	3.00 (0.118)	5.44 (0.214)	2
SMD100F/33	1.10	2.20	33	40	0.120	0.410	UL, TÜV, CSA	7.98 (0.314)	3.00 (0.118)	5.44 (0.214)	2
<b>New</b> SMDH120	1.20	1.50	16	50	0.150	0.340	Pending	7.98 (0.314)	3.00 (0.118)	5.44 (0.214)	2
SMD125F	1.25	2.50	15	40	0.070	0.250	UL, TÜV, CSA	7.98 (0.314)	3.00 (0.118)	5.44 (0.214)	2
SMD260F	2.60	5.20	6	40	0.025	0.075	UL, TÜV, CSA	7.98 (0.314)	3.00 (0.118)	5.44 (0.214)	2
SMD300F	3.00	6.00	6	40	0.015	0.048	UL, TÜV, CSA	7.98 (0.314)	3.00 (0.118)	5.44 (0.214)	2

**SMD2 Series Size: 8763 (mm), 3425 (mils)**

**ELV Compliant, RoHS Compliant**

Part number	I <sub>H</sub> (A)	I <sub>T</sub> (A)	V max. (Vdc)	I max. (A)	R <sub>min</sub> (Ω)	R <sub>1</sub> max. (Ω)	Agency recognition	Dimensions (millimeters/inches)			
								A (max.)	B (max.)	C (max.)	Fig.
SMD150F	1.50	3.00	15	40	0.060	0.250	UL, TÜV, CSA	9.40 (0.370)	3.00 (0.118)	6.71 (0.264)	2
SMD150F/33	1.50	3.00	33	40	0.080	0.230	UL, TÜV, CSA	9.40 (0.370)	3.00 (0.118)	6.71 (0.264)	2
SMDH160	1.60	3.20	16	70	0.050	0.150	Pending	9.40 (0.370)	3.00 (0.118)	6.71 (0.264)	2
SMD185F	1.80	3.60	33	40	0.065	0.165	UL, TÜV, CSA	9.40 (0.370)	3.00 (0.118)	6.71 (0.264)	2
SMD200F	2.00	4.00	15	40	0.050	0.125	UL, TÜV, CSA	9.40 (0.370)	3.00 (0.118)	6.71 (0.264)	2
SMD250F	2.50	5.00	15	40	0.035	0.085	UL, TÜV, CSA	9.40 (0.370)	3.00 (0.118)	6.71 (0.264)	2

**VLR: 85°C Typical Activation**

**ELV Compliant, RoHS Compliant**

This product line is designed for battery pack applications. Several material platforms are available to help meet the specific protection needs of different cell chemistries (e.g. Li-ion, NiMH, and NiCd). A variety of space efficient form factors helps the designer minimize pack size.

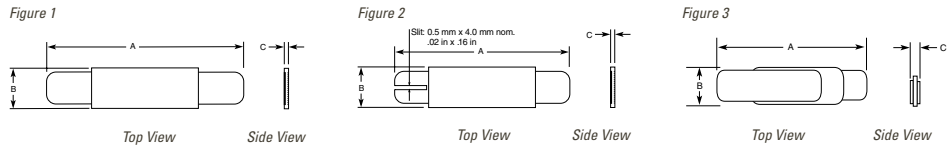

Part number	I <sub>H</sub> * (A)	I <sub>T</sub> (A)	V max. (Vdc)	I max. (A)	R max. initial (Ω)	Agency recognition	Dimensions (millimeters/inches)			Fig.
							A (max.)	B (max.)	C (max.)	
VLR170F	1.7	4.1	12	100	0.032	UL, TÜV, CSA	23.2 (0.913)	3.9 (0.153)	0.8 (0.032)	1
VLR170L†	1.7	4.1	12	100	0.032	UL, TÜV, CSA	41.2 (1.622)	3.9 (0.153)	0.8 (0.032)	1
VLR170UF	1.7	4.1	12	100	0.032	UL, TÜV, CSA	23.2 (0.913)	3.7 (0.146)	0.7 (0.028)	3
VLR175F	1.75	4.2	12	100	0.031	UL, TÜV, CSA	24.5 (0.965)	3.3 (0.130)	0.8 (0.032)	1
VLR175LF	1.75	4.2	12	100	0.031	UL, TÜV, CSA	31.7 (1.248)	3.3 (0.130)	0.8 (0.032)	1
VLR175UF	1.75	4.2	12	100	0.031	UL, TÜV, CSA	24.5 (0.96)	3.1 (0.12)	0.7 (0.028)	3
VLR230F	2.3	5	12	100	0.018	UL, TÜV, CSA	23.1 (0.909)	5.3 (0.208)	0.8 (0.032)	1
VLR230-C36†	2.3	5	12	100	0.018	UL, TÜV, CSA	27.7 (1.091)	3.9 (0.153)	0.8 (0.032)	1
VLR230S†	2.3	5	12	100	0.018	UL, TÜV, CSA	23.1 (0.909)	5.3 (0.208)	0.8 (0.032)	2
VLR230SU†	2.3	5	12	100	0.018	UL, TÜV, CSA	23.1 (0.909)	5.1 (0.201)	0.7 (0.028)	2
VLR230UF	2.3	5	12	100	0.018	UL, TÜV, CSA	23.1 (0.909)	5.1 (0.201)	0.7 (0.028)	3

\* Hold current @ 25°C.

† Please contact Raychem Circuit Protection for RoHS compliant version.

**VLP: 90°C Typical Activation**

**ELV Compliant, RoHS Compliant**

Providing both overcurrent and overtemperature protection, the low-resistance characteristics of the VLP devices help battery pack designers lower pack impedance. In addition, the VLP devices narrow, low-profile form factor and axial leads allow them to be welded directly to battery cells, conserving valuable space in portable electronics applications.

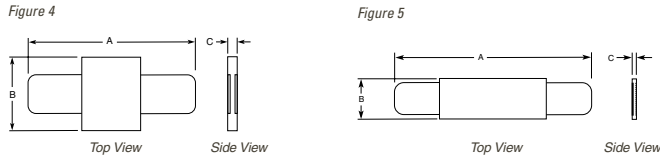

Part number	I <sub>H</sub> * (A)	I <sub>T</sub> (A)	V max. (Vdc)	I max. (A)	R max. initial (Ω)	Agency recognition	Dimensions (millimeters/inches)			Fig.
							A (max.)	B (max.)	C (max.)	
VLP210†	2.1	5	16	60	0.030	UL, TÜV, CSA	17.5 (0.689)	7.3 (0.287)	0.8 (0.032)	4
VLP220F	2.2	5.3	16	60	0.029	UL, TÜV, CSA	23.3 (0.917)	3.9 (0.154)	0.8 (0.032)	5
VLP270F	2.7	6.5	16	60	0.018	UL, TÜV, CSA	23.1 (0.909)	5.3 (0.208)	0.8 (0.032)	5

\* Hold current @ 25°C.

† Please contact Raychem Circuit Protection for RoHS compliant version.

## VTP: 90°C Typical Activation

### ELV Compliant, RoHS Compliant

The conductive polymer composite in the VTP battery overcurrent protection devices helps provide increased safety with extended battery run time. These devices reach a high-resistance state at lower temperatures in NiMH and rechargeable lithium temperature-sensitive chemistries.

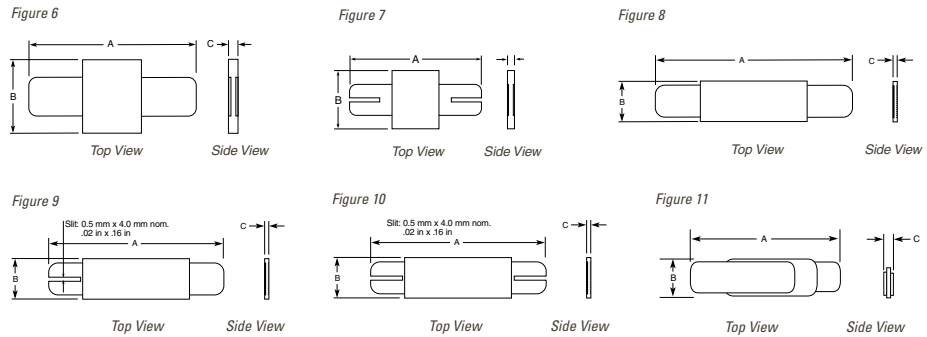

Part number	I <sub>H</sub> * (A)	I <sub>T</sub> (A)	V max. (Vdc)	I max. (A)	R max. initial (Ω)	Agency recognition	Dimensions (millimeters/inches)			Fig.
							A (max.)	B (max.)	C (max.)	
VTP110F	1.1	2.7	16	100	0.070	UL, TÜV, CSA	25.6 (1.007)	2.9 (0.114)	0.7 (0.028)	11
VTP170F	1.7	3.4	16	100	0.052	UL, TÜV, CSA	17.5 (0.689)	7.4 (0.292)	0.8 (0.03)	6
VTP170X†	1.7	3.4	16	100	0.052	UL, TÜV, CSA	22.9 (0.90)	5.3 (0.21)	0.8 (0.03)	8
VTP170XSF	1.7	3.4	16	100	0.052	UL, TÜV, CSA	22.9 (0.90)	5.3 (0.21)	0.8 (0.03)	9
VTP175LF	1.75	3.6	16	100	0.051	UL, TÜV, CSA	28.0 (1.10)	3.9 (0.15)	0.8 (0.03)	8
VTP175UF	1.75	3.6	16	100	0.051	UL, TÜV, CSA	23.2 (0.91)	3.7 (0.15)	0.7 (0.03)	11
VTP200GF	2.0	4.7	16	100	0.039	UL, TÜV, CSA	23.1 (0.91)	4.5 (0.18)	0.8 (0.03)	8
VTP200U†	2.0	4.7	16	100	0.039	UL, TÜV, CSA	23.1 (0.91)	4.3 (0.17)	0.7 (0.03)	11
VTP210GF	2.1	4.7	16	100	0.030	UL, TÜV, CSA	23.1 (0.91)	5.3 (0.21)	0.8 (0.03)	8
VTP210LF	2.1	4.7	16	100	0.030	UL, TÜV, CSA	26.0 (1.02)	5.3 (0.21)	0.8 (0.03)	8
VTP210SF	2.1	4.7	16	100	0.030	UL, TÜV, CSA	23.1 (0.91)	5.3 (0.21)	0.8 (0.03)	9
VTP210SLF	2.1	4.7	16	100	0.030	UL, TÜV, CSA	32.0 (1.26)	5.3 (0.21)	0.8 (0.03)	9
VTP210SL-19.2/5.8†	2.1	4.7	16	100	0.030	UL, TÜV, CSA	37.0 (1.46)	5.3 (0.21)	0.8 (0.03)	9
VTP210SSF	2.1	4.7	16	100	0.030	UL, TÜV, CSA	23.1 (0.91)	5.3 (0.21)	0.8 (0.03)	10
VTP210ULD†	2.1	4.7	16	100	0.030	UL, TÜV, CSA	25.2 (1.00)	5.1 (0.20)	0.8 (0.03)	11
VTP240F	2.4	5.9	16	100	0.026	UL, TÜV, CSA	26.2 (1.03)	5.3 (0.21)	0.8 (0.03)	8

\* Hold current @ 25°C.

† Please contact Raychem Circuit Protection for RoHS compliant version.

## LTP, miniSMDE: 110°C Typical Activation

### ELV Compliant, RoHS Compliant

LTP devices help provide reliable, noncycling protection for rechargeable batteries. LTP devices also help provide additional protection at elevated temperatures.

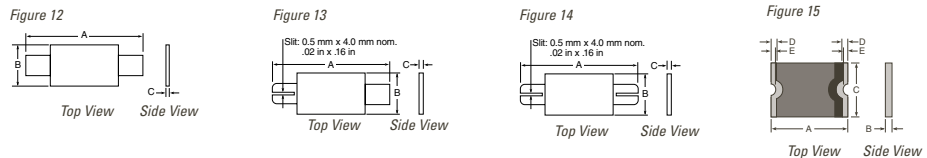

Part number	I <sub>H</sub> (A)	I <sub>T</sub> (A)	V max. (Vdc)	I max. (A)	R max. initial (Ω)	Agency recognition	Dimensions (millimeters/inches)			Fig.
							A (max.)	B (max.)	C (max.)	
<b>LTP</b>										
LTP070†	0.7	1.45	15	100	0.200	UL, TÜV, CSA	22.1 (0.87)	5.2 (0.20)	1.2 (0.048)	12
LTP070SF	0.7	1.45	15	100	0.200	UL, TÜV, CSA	22.1 (0.87)	5.2 (0.20)	1.2 (0.048)	13
LTP100F	1.0	2.5	24	100	0.130	UL, TÜV, CSA	23.1 (0.91)	5.2 (0.20)	1.0 (0.04)	12
LTP100SF	1.0	2.5	24	100	0.130	UL, TÜV, CSA	23.1 (0.91)	5.2 (0.20)	1.0 (0.04)	13
LTP100SL†	1.0	2.5	24	100	0.130	UL, TÜV, CSA	32.0 (1.26)	5.2 (0.20)	1.0 (0.04)	13
LTP100SS†	1.0	2.5	24	100	0.130	UL, TÜV, CSA	23.1 (0.91)	5.2 (0.20)	1.0 (0.04)	14
LTP180F	1.8	3.8	24	100	0.068	UL, TÜV, CSA	26.0 (1.02)	5.2 (0.20)	1.0 (0.04)	12
LTP180LF	1.8	3.8	24	100	0.068	UL, TÜV, CSA	37.5 (1.48)	5.2 (0.20)	1.0 (0.04)	12
LTP180S†	1.8	3.8	24	100	0.068	UL, TÜV, CSA	26.0 (1.02)	5.2 (0.20)	1.0 (0.04)	13
LTP190F	1.9	4.2	24	100	0.057	UL, TÜV, CSA	23.4 (0.92)	11.0 (0.43)	1.1 (0.04)	12
LTP260†	2.6	5.2	24	100	0.042	UL, TÜV, CSA	26.0 (1.02)	11.9 (0.47)	1.0 (0.04)	12
LTP300F	3.0	6.3	24	100	0.031	UL, TÜV, CSA	31.8 (1.25)	13.5 (0.53)	1.1 (0.04)	12
LTP340†	3.4	6.8	24	100	0.027	UL, TÜV, CSA	26.0 (1.02)	15.9 (0.63)	1.0 (0.04)	12
<b>miniSMDE</b>										
miniSMDE190F	1.9	3.8	16	100	0.040	UL, TÜV, CSA	11.51 (0.453)	0.53 (0.021)	5.33 (0.21)	15

† Please contact Raychem Circuit Protection for RoHS compliant version.



**LR4, SRP: 120°C Typical Activation**

**ELV Compliant, RoHS Compliant**

The LR4 devices' smaller thermal mass means reduced reaction time to over-current events. The LR4 devices are suited for battery packs intended for computer and camcorder applications. The SRP products help provide reliable, non-cycling protection for rechargeable batteries. Weldable nickel leads and a narrow, low-profile design make these devices easy to install directly onto battery cells.

Figure 16

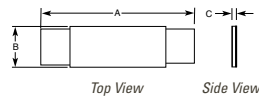

Figure 17

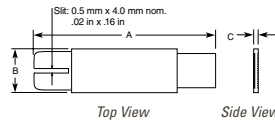

Figure 18

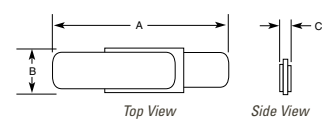

Figure 19

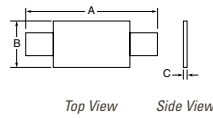

Figure 20

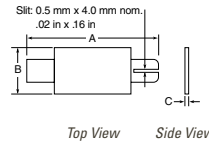
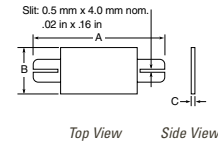

Figure 21



Part number	I <sub>H</sub> (A)	I <sub>T</sub> (A)	V max. (Vdc)	I max. (A)	R max. initial (Ω)	Agency recognition	Dimensions (millimeters/inches)			Fig.
							A (max.)	B (max.)	C (max.)	
<b>LR4</b>										
LR4-170UF	1.7	3.4	15	100	0.078	UL	21.0 (0.83)	4.0 (0.16)	0.7 (0.03)	18
LR4-190F	1.9	3.9	15	100	0.072	UL, TÜV, CSA	22.1 (0.87)	5.5 (0.22)	1.0 (0.04)	16
LR4-190S†	1.9	3.9	15	100	0.072	UL, TÜV, CSA	22.1 (0.87)	5.5 (0.22)	1.0 (0.04)	17
LR4-260F	2.6	5.8	15	100	0.042	UL, TÜV, CSA	23.1 (0.91)	5.5 (0.22)	1.0 (0.04)	16
LR4-260SF	2.6	5.8	15	100	0.042	UL, TÜV, CSA	23.1 (0.91)	5.5 (0.22)	1.0 (0.04)	17
LR4-380F	3.8	8.3	15	100	0.026	UL, TÜV, CSA	26.0 (1.02)	7.5 (0.30)	1.0 (0.04)	16
LR4-380X†	3.8	8.3	15	100	0.026	UL, TÜV, CSA	35.8 (1.41)	5.5 (0.22)	1.0 (0.04)	16
LR4-450F	4.5	8.9	20	100	0.020	UL, TÜV, CSA	26.0 (1.02)	10.5 (0.41)	1.0 (0.04)	16
LR4-550F	5.5	10.5	20	100	0.016	UL, TÜV, CSA	37.0 (1.46)	7.5 (0.30)	1.0 (0.04)	16
LR4-600F	6.0	11.7	20	100	0.014	UL, TÜV, CSA	26.0 (1.02)	14.5 (0.57)	1.0 (0.04)	16
LR4-600X†	6.0	11.7	20	100	0.014	UL, TÜV, CSA	42.7 (1.68)	7.5 (0.30)	1.0 (0.04)	16
LR4-730F	7.3	14.1	20	100	0.012	UL, TÜV, CSA	29.1 (1.15)	14.5 (0.57)	1.0 (0.04)	16
LR4-880SS†	8.8	16	20	100	0.0105	UL, TÜV, CSA	65.2 (2.57)	8.5 (0.33)	1.0 (0.04)	17
LR4-900F	9.0	16.7	20	100	0.010	UL, TÜV, CSA	47.6 (1.874)	8.5 (0.335)	1.3 (0.05)	16
LR4-1300SSF	13.0	21.2	20	100	0.0065	UL, TÜV, CSA	66.5 (2.62)	10.0 (0.39)	1.3 (0.05)	17
LR4-1410†	14.1	26.2	20	100	0.005	UL, TÜV, CSA	60.0 (2.36)	14.0 (0.55)	1.3 (0.05)	16
<b>SRP</b>										
SRP120F	1.2	2.7	15	100	0.160	UL, TÜV, CSA	22.1 (0.87)	5.2 (0.20)	1.0 (0.04)	19
SRP120L†	1.2	2.7	15	100	0.160	UL, TÜV, CSA	27.1 (1.07)	5.2 (0.20)	1.0 (0.04)	19
SRP120SF	1.2	2.7	15	100	0.160	UL, TÜV, CSA	22.1 (0.87)	5.2 (0.20)	1.0 (0.04)	20
SRP175F	1.75	3.8	15	100	0.090	UL, TÜV, CSA	23.1 (0.91)	5.2 (0.20)	1.0 (0.04)	19
SRP175LF	1.75	3.8	15	100	0.090	UL, TÜV, CSA	32.1 (1.26)	5.2 (0.20)	1.0 (0.04)	19
SRP175SF	1.75	3.8	15	100	0.090	UL, TÜV, CSA	23.1 (0.91)	5.2 (0.20)	1.0 (0.04)	20
SRP175SS†	1.75	3.8	15	100	0.090	UL, TÜV, CSA	23.1 (0.91)	5.2 (0.20)	1.0 (0.04)	21
SRP200F	2.0	4.4	30	100	0.060	UL, TÜV, CSA	23.4 (0.92)	11.0 (0.43)	1.1 (0.04)	19
SRP350F	3.5	6.3	30	100	0.031	UL, TÜV, CSA	31.8 (1.25)	13.5 (0.53)	1.1 (0.04)	19
SRP420F	4.2	7.6	30	100	0.024	UL, TÜV, CSA	32.4 (1.28)	13.6 (0.54)	1.1 (0.04)	19

† Please contact Raychem Circuit Protection for RoHS compliant version.

## Definitions

**$I_H$**  = Hold current—maximum current at which the device will not trip under specified conditions at 20°C unless otherwise specified.

**$I_{max}$**  = The highest fault current that can safely be used to trip a PolySwitch device under specified conditions.

**$V_{max}$**  = The highest voltage that can safely be dropped across a PolySwitch device continuously in its tripped state under specified fault conditions.

**$R_1max$**  = Maximum device resistance under specified conditions measured 1 hour post trip or post reflow.

**$R_a max$**  = Maximum device resistance under automotive conditions specified in PS400 measured 1 hour after stress has been removed.

**$Rmax, Initial$**  = Maximum device resistance under specified conditions as supplied.

**$I_T$**  = Minimum current at which a device will trip under specified conditions.

### WARNING!

- Operation beyond maximum ratings or improper use may result in device damage and possible electrical arcing and flame.
- These devices are intended for protection against occasional overcurrent or overtemperature fault conditions, and should not be used when repeated fault conditions are anticipated.
- TR and TS devices are not intended for continuous utility line voltage such as 120/220V or 240V.
- LVR Product Notes:
  1. A PTC device is not a fuse—it is a nonlinear thermistor that limits current. Because under a fault condition all PTC devices go into a high resistance state but not open circuit, hazardous voltage may be present at PTC locations.
  2. The devices are intended for protection against occasional overcurrent or overtemperature fault conditions and should not be used when repeated fault conditions or prolonged trip events are anticipated.
  3. Please refer to the SCD for complete information and applications limitations, which can be obtained from product management (650-361-6900) or the web: [www.circuitprotection.com/lvr/](http://www.circuitprotection.com/lvr/)

## Voltage Rating for Telecom Devices

For Raychem Circuit Protection telecom devices (TC, TGC, TRx, TSx) there are two applicable voltage ratings. These are  **$V_{max, Operating}$**  and  **$V_{max, Interrupt}$** . To help understand the nature of these two different voltage ratings the following definitions are provided:

**$V_{max, Interrupt}$** : Under specified conditions this is the highest voltage that can be applied to the device at the maximum current. Devices have been designed to trip safely under higher power level cross conditions, as listed above, to assist equipment in meeting the appropriate industry conditions.

**$V_{max, Operating}$** : For telecom devices this is the voltage we have used to obtain component recognition under UL1434. Most Raychem Circuit Protection devices (TC, TGC, TRx, TSx) are certified at 60V but can withstand higher  $V_{max}$ . TR600 and TS600 product families are certified at 250V but can withstand higher  $V_{max}$ . Interrupt conditions as noted above.

For the purposes of this brochure we have included in the table of electrical ratings the more applicable  $V_{max, Interrupt}$  value.

Standard PolySwitch product families include, RGEF, RHEF, RTEF, RUEF, RXEF, LVR, SMDF, nanoSMDF, microSMDF, miniSMDF, BBRF, LR4F, LTPF, SRPF, VTPF, VLRF, VLRF, AHRF, AGRF, and AHS. PolySwitch TS, TR and ASMD product families offer a selected number of RoHS compliant parts. In addition, special devices, such as speaker devices (SPK), terminal devices (TD) and custom chip devices, can be manufactured to meet performance requirements that could be outside of the performance band of the standard products listed in this short form catalog. Please contact a Raychem Circuit Protection Customer Service representative to discuss your special product needs.

## Agency approvals for PolySwitch devices:

PolySwitch devices, where appropriate, have been tested and have gained the following safety agency approvals:

- UL Component Recognition in Category XGPU2, Thermistor Type Devices
- CSA Component Acceptance Class 9073 32, Thermistors—PTC Type
- TÜV Rheinland Certification, PTC Resistors



**Worldwide Headquarters**

308 Constitution Drive, MS R21/2A  
Menlo Park, CA USA 94025-1164  
Tel (800) 227-7040  
(650) 361-6900  
Fax (650) 361-2508

www.circuitprotection.com  
www.circuitprotection.com.hk (Chinese)  
www.raychem.co.jp/polyswitch (Japanese)

**South America****Argentina**

Tel 54-11-4394-5150  
Fax 54-11-4326-9985

**Brazil**

Tel 55-11-5181-4788  
Fax 55-11-5181-4790

**Chile**

Tel 56-2-209-8211  
Fax 56-2-223-1477

**Colombia**

Tel 57-1-218-2460  
Fax 57-1-218-2472

**Peru**

Tel 51-1-221-4165  
Fax 51-1-421-0368

**Uruguay**

Tel 59-8-982-2428  
Fax 59-8-982-2430

**Venezuela**

Tel 58-2-242-6475  
Fax 58-2-241-8260

**Europe****UK/EIRE/****Nordic Countries**

Tel (32) 16-352028  
Fax (32) 16-351319

**Germany/Austria/****Switzerland/****Eastern Europe**

Tel (49) 89-6089386  
Fax (49) 89-6089394

**France/Benelux/****Italy/Iberia**

Tel (33) 1-34202114  
Fax (33) 1-34202324

**Other Countries**

Tel (32) 16-351321  
Fax (32) 16-351319

**Asia/Pacific****China, Beijing**

Tel 86-10-6581-5606  
Fax 86-10-6581-5608

**China, Guangzhou**

Tel 86-20-8330-9933  
Fax 86-20-8385-6139

**China, Hong Kong**

Tel 852-2738-3401  
Fax 852-2735-1185

**China, Shanghai**

Tel 86-21-6485-3288  
Fax 86-21-6485-5109

**China, Shenzhen**

Tel 86755-25154797  
Fax 86755-25980419

**India, Bangalore**

Tel 91-80-51121776  
Fax 91-80-25586039

**Japan**

Tel 81-44-900-5110  
Fax 81-44-900-5140

**Korea**

Tel 82-2-3415-4654  
Fax 82-2-3486-1786

**Malaysia**

Tel 6-04-611-2119  
Fax 6-04-644-9521

**Australia/Philippines**

Tel 63-2-848-0171  
Fax 63-2-867-8661

**Singapore**

Tel 65-6416-4205  
Fax 65-6484-0661

**Taiwan**

Tel 886-2-2662-9788  
Fax 886-2-2662-4684

**Thailand**

Tel 66-1-875-5758  
Fax 66-2-617-1939

*PolySwitch, SiBar, miniSMD, microSMD, and nanoSMD are trademarks of Tyco Electronics Corporation.*

*All information, including illustrations, is believed to be reliable. Users, however, should independently evaluate the suitability of each product for their application. Tyco Electronics Corporation makes no warranties as to the accuracy or completeness of the information, and disclaims any liability regarding its use. Tyco Electronics' only obligations are those in the Company's Standard Terms and Conditions of Sale for this product, and in no case will Tyco Electronics be liable for any incidental, indirect, or consequential damages arising from the sale, resale, use, or misuse of the product. Specifications are subject to change without notice. In addition, Tyco Electronics reserves the right to make changes—without notification to Buyer—to materials or processing that do not affect compliance with any applicable specification.*