

Features

- Specially suited for use in audio and telephone electret capacitor microphones
- Excellent voltage gain
- Very low noise
- High ESD voltage
- Ultra-small size package

Applications

- Cellular phones
- Portable audio
- PDAs
- MP3 players

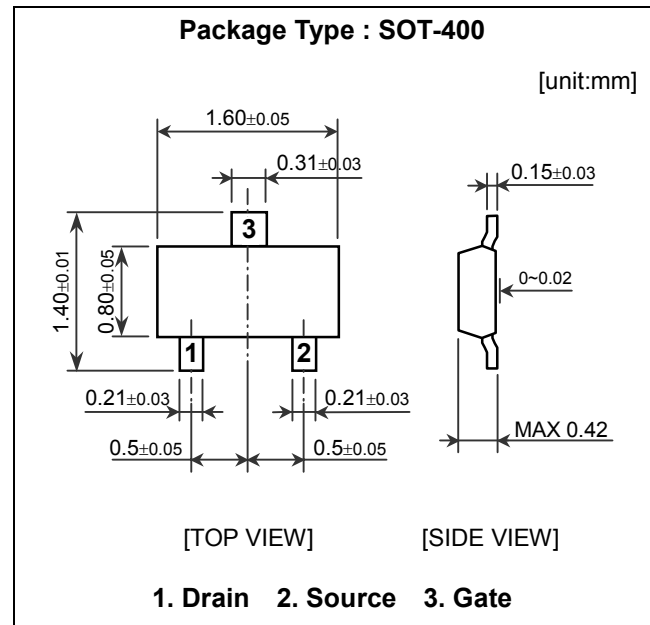

Absolute Maximum Ratings at Ta = 25 °C

Parameter	Symbol	Ratings	Unit
Gate-to-Drain Voltage	V_{GDO}	-20	V
Gate Current	I_G	10	mA
Drain Current	I_D	10	mA
Allowable Power Dissipation	P_D	100	mW
Junction Temperature	T_j	150	°C
Storage Temperature	T_{stg}	-55 to +150	°C

Electrical Characteristics at Ta = 25 °C

Parameter	Symbol	Conditions	Ratings			Unit
			Min	Typ	Max	
Gate-to-Drain Breakdown Voltage	$V_{(BR)GDO}$	$I_G = -100\mu A$	-20			V
Cutoff Voltage	$V_{GS(off)}$	$V_{DS} = 5V, I_D = 1\mu A$	-0.2	-0.6	-1.5	V
Zero-Gate Voltage Drain Current	I_{DSS}	$V_{DS} = 5V, V_{GS} = 0$	70*		430*	μA
Forward Transfer Admittance	$ y_{fs} $	$V_{DS} = 5V, V_{GS} = 0, f = 1kHz$	0.4	1.2		mS
Input Capacitance	C_{iss}	$V_{DS} = 5V, V_{GS} = 0, f = 1MHz$		3.5		pF
Reverse Transfer Capacitance	C_{rss}	$V_{DS} = 5V, V_{GS} = 0, f = 1MHz$		0.8		pF

* The RJN1164 is classified by I_{DSS} as follows

Classification	A1	A2	B	C	D
$I_{DSS}(\mu A)$	70~120	100~170	150~270	210~350	320~430

RJN1164

Electrical Characteristics

Parameter	Symbol	Conditions	Min	Typ	Max	Unit
[Ta = 25 °C, VCC = 4.5V, RL = 1kΩ, CIN = 15pF, See Specified Test Circuit.]						
Voltage Gain	G _V	V _{IN} = 10 mV, f = 1kHz		-3.0		dB
Reduced Voltage Characteristics	ΔG _{VV}	V _{IN} = 10 mV, V _{CC} = 4.5 → 1.5V		-1.2	-3.5	dB
Frequency Characteristics	ΔG _{Vf}	f = 1kHz to 110Hz			-1.0	dB
Input Impedance	Z _{IN}	f = 1kHz	30			MΩ
Output Impedance	Z _O	f = 1kHz			700	Ω
Total Harmonic Distortion	THD	V _{IN} = 10mV, f = 1kHz		1.0		%
Output Noise Voltage	V _{NO}	V _{IN} = 0, A curve			-110	dB

Test Circuit

- Voltage Gain
- Frequency Characteristics
- Distortion
- Reduced Voltage Characteristics

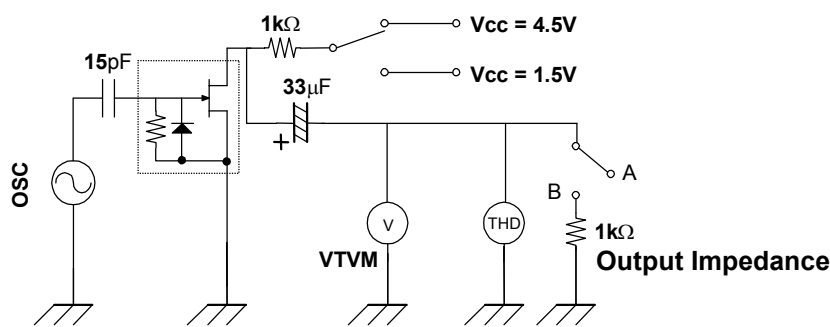

www.DataSheet4U.com

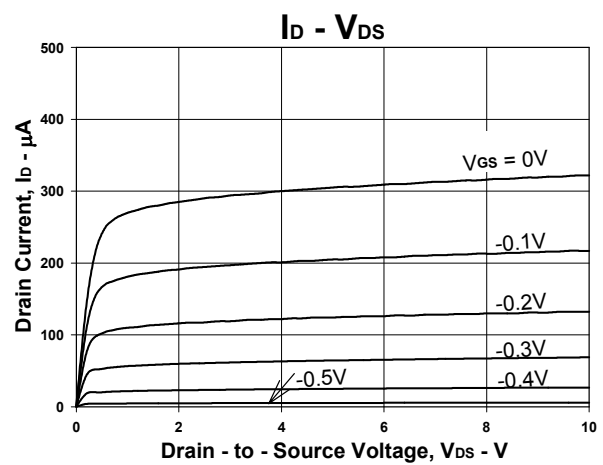
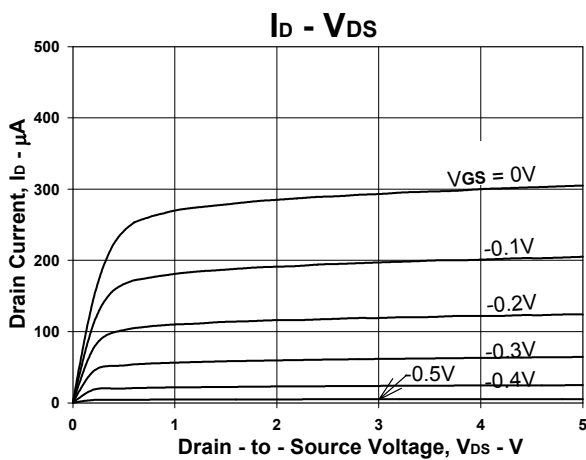

RJN1164

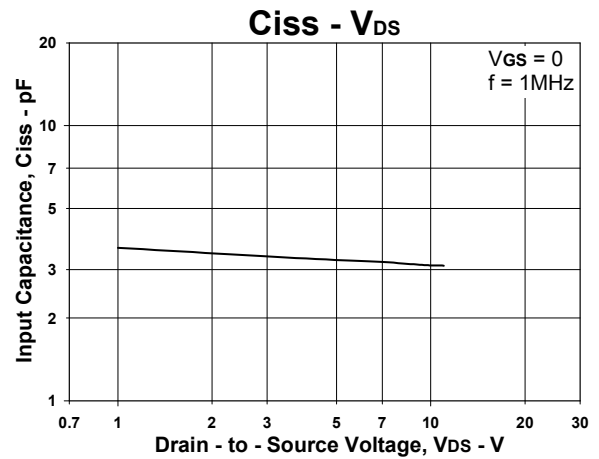
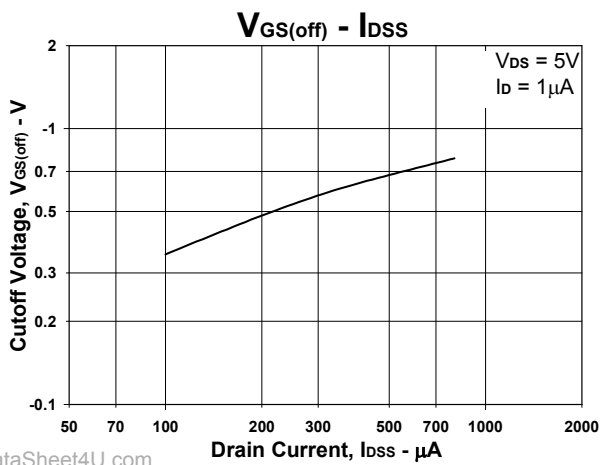
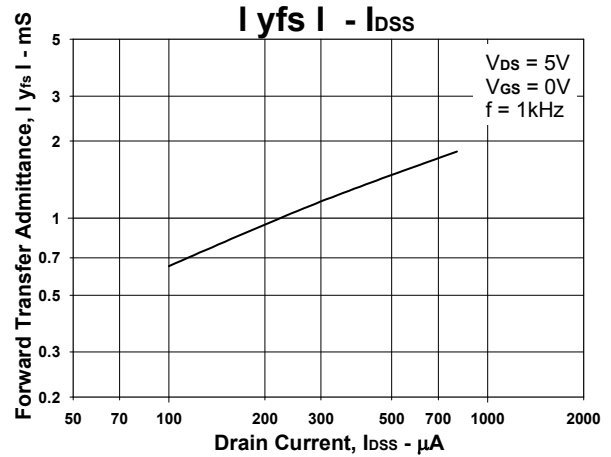
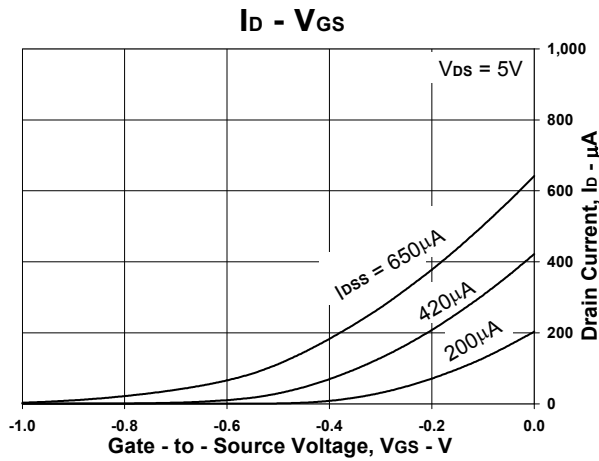

www.DataSheet4U.com

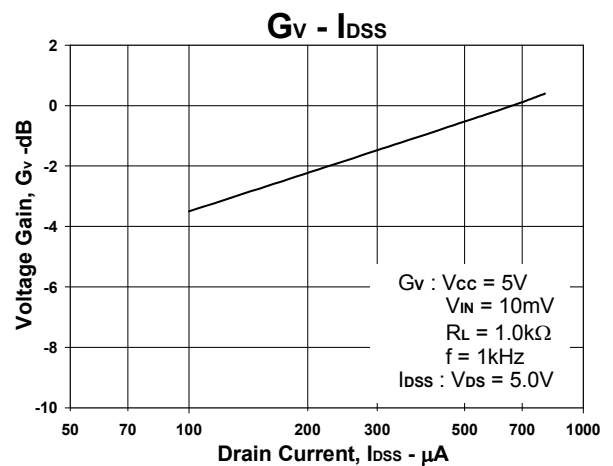
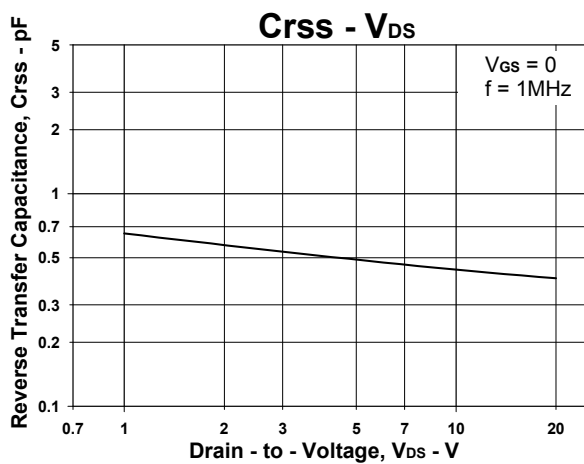

RJN1164

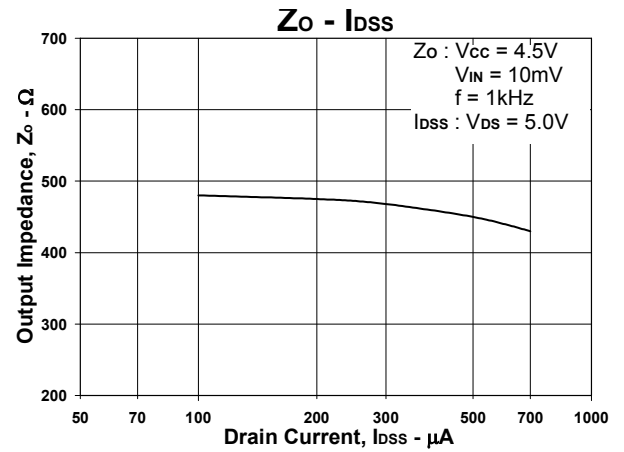
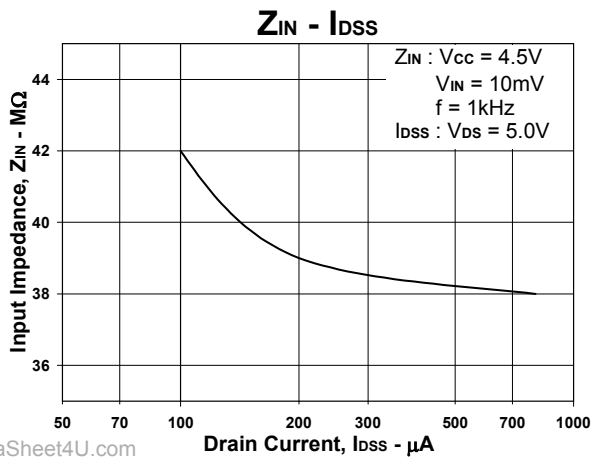
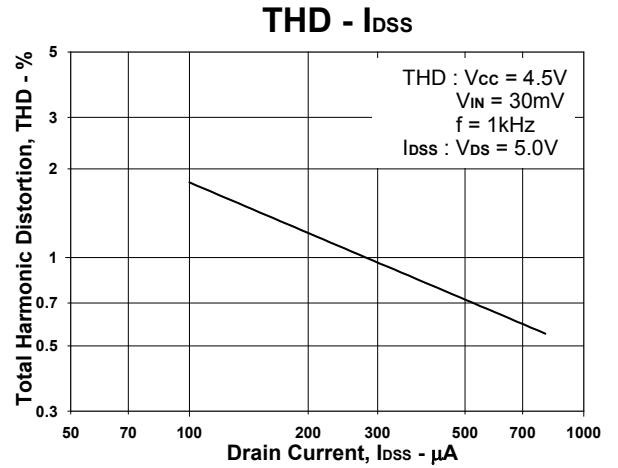
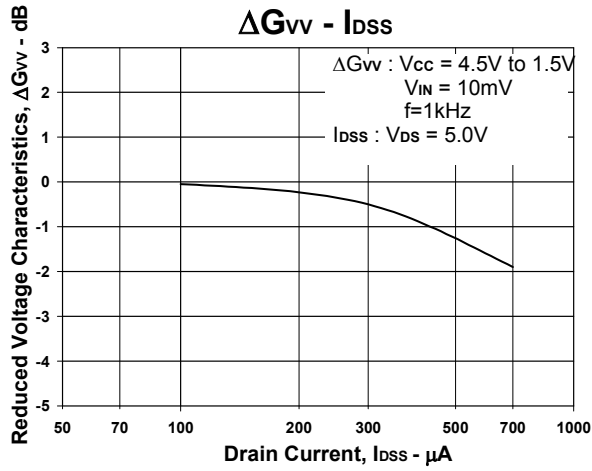

www.DataSheet4U.com

