



0.56" Dual Digit Display.

Part Number:

RL-D5610GDBW
 RL-D5620SBRW

RL-D5610YCBW
 RL-D5620RCBW

RL-D5620OCAW

Features

1. LOW POWER CONSUMPTION.
2. RELIABLE AND RUGGED.
3. EXCELLENT UNIFORMITY OF LIGHT OUTPUT.
4. SUITABLE FOR LEVEL INDICATOR.
5. I.C COMPATIBLE.
6. LONG LIFE-SOLIDSTATE RELIABILITY.

Notes:

1. All dimensions are in millimeters (inches)
2. Tolerance is $\pm 0.25(0.01)$ unless otherwise niter
3. Lead spacing is measured where the lead emerge package
4. Specifications are subject to change without notice

Package Dimensions & Internal Circuit Diagram.

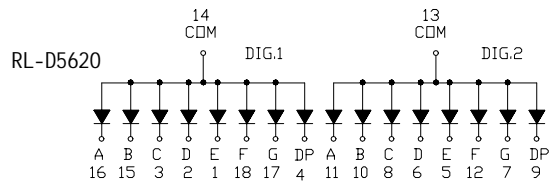
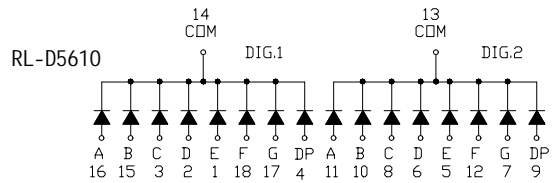
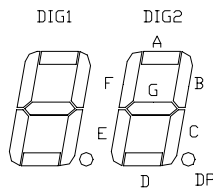
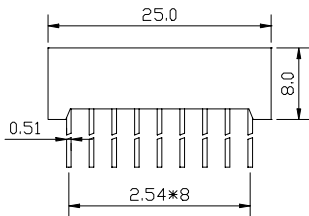
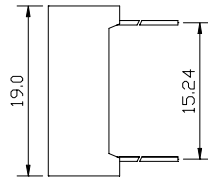
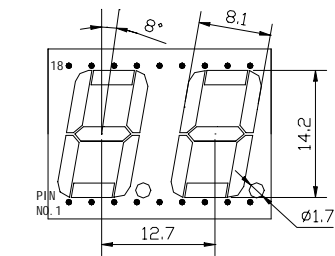

Selection Guide,

Part NO.	Chip			Vf (V)			Face Color	C.C Or CA
	Material	Emitted Color	λ_p (nm)	Typ.	Max	At IF=mA		
RL-D5610GDBW	GaP	Yellow Green	570	2000	3000	20	Black	C.C.
RL-D5610YCBW	GaAsP/GaP	Yellow	585	960	1440	20	Black	C.C
RL-D5620OCAW	GaAsP/GaP	Orange Red	630	1220	1830	20	Gray	C.A.
RL-D5620SBRW	GaAlAs	Super Red	660	2750	4120	20	Red	C.A.
RL-D5620RCBW	GaP/GaP	Bight Red	700	200	300	20	Black	C.A.

1. All dimensions are in millimeters (inches), Tolerance is $\pm 0.25(0.01)$ unless otherwise noted.
2. Specifications are subject to change without notice.



EXCEED PERSEVERANCE ELECTRONIC INDUSTRY CO., LTD.

深圳市超毅光电子有限公司

0.56" Dual Digit Display.

Part Number:

RL-D5611GDBW
RL-D5621SBRW

RL-D5611YCBW
RL-D5621RCBW

RL-D5621OCAW

Features

1. LOW POWER CONSUMPTION.
2. RELIABLE AND RUGGED.
3. EXCELLENT UNIFORMITY OF LIGHT OUTPUT.
4. SUITABLE FOR LEVEL INDICATOR.
5. I.C COMPATIBLE.
6. LONG LIFE-SOLIDSTATE RELIABILITY.

Notes:

1. All dimensions are in millimeters (inches)
2. Tolerance is $\pm 0.25(0.01'')$ unless otherwise niter
3. Lead spacing is measured where the lead emerge package
4. Specifications are subject to change without notice

Package Dimensions & Internal Circuit Diagram.

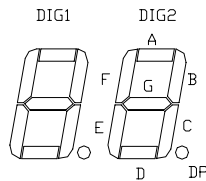
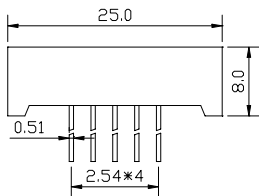
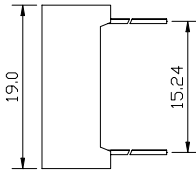
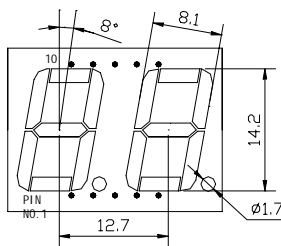

RL-D5611

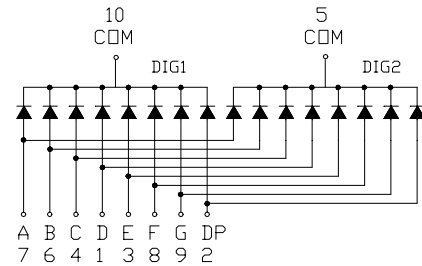

RL-D5621

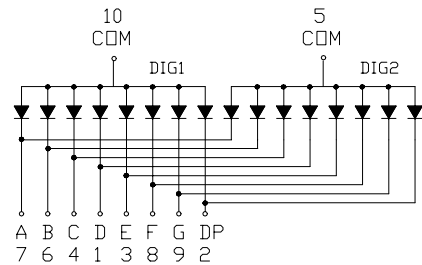

Selection Guide,

Part NO.	Chip			Vf (V)			Face Color	C.C Or CA
	Material	Emitted Color	Δp (nm)	Typ.	Max	At IF=mA		
RL-D5611GDBW	GaP	Yellow Green	570	2000	3000	20	Black	C.C.
RL-D5611YCBW	GaAsP/GaP	Yellow	585	960	1440	20	Black	C.C
RL-D5621OCAW	GaAsP/GaP	Orange Red	630	1220	1830	20	Gray	C.A.
RL-D5621SBRW	GaAlAs	Super Red	660	2750	4120	20	Red	C.A.
RL-D5621RCBW	GaP/GaP	Bight Red	700	200	300	20	Black	C.A.

1. All dimensions are in millimeters (inches), Tolerance is $\pm 0.25(0.01'')$ unless otherwise noted.
2. Specifications are subject to change without notice.



EXCEED PERSEVERANCE ELECTRONIC INDUSTRY CO., LTD.

深圳市超毅光电子有限公司

0.56" Dual Digit Display.

Part Number:

RL-D5613GDBW
RL-D5623SBRW

RL-D5613YCBW
RL-D5623RCBW

RL-D5623OCAW

Features

- 1.LOW POWER CONSUMPTION.
- 2.RELIABLE AND RUGGED.
- 3.EXCELLENT UNIFORMITY OF LIGHT OUTPUT.
- 4.SUITABLE FOR LEVEL INDICATOR.
- 5.I.C COMPATIBLE.
- 6.LONG LIFE-SOLIDSTATE RELIABILTY.

Notes:

- 1.All dimensions are in millimeters (inches)
- 2.Tolerance is $\pm 0.25(0.01'')$ unless otherwise niter
- 3.Lead spacing is measured where the lead emerge package
- 4.Specifications are subject to change without notice

Package Dimensions & Internal Circuit Diagram.

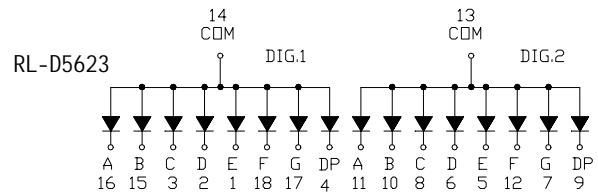
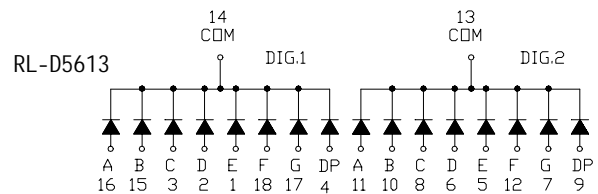
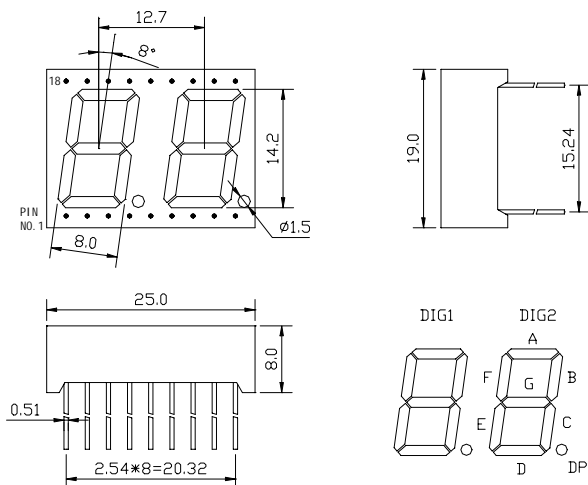

Selection Guide,

Part NO.	Chip			Vf (V)			Face Color	C.C Or CA
	Material	Emitted Color	Δp (nm)	Typ.	Max	At IF=mA		
RL-D5613GDBW	GaP	Yellow Green	570	2000	3000	20	Black	C.C.
RL-D5613YCBW	GaAsP/GaP	Yellow	585	960	1440	20	Black	C.C
RL-D5623OCAW	GaAsP/GaP	Orange Red	630	1220	1830	20	Gray	C.A.
RL-D5623SBRW	GaAlAs	Super Red	660	2750	4120	20	Red	C.A.
RL-D5623RCBW	GaP/GaP	Bight Red	700	200	300	20	Black	C.A.

1.All dimensions are in millimeters (inches), Tolerance is $\pm 0.25(0.01'')$ unless otherwise noted.

2.Specifications are subject to change without notice.



EXCEED PERSEVERANCE ELECTRONIC INDUSTRY CO., LTD.

深圳市超越光电子有限公司

Electrical optical characteristics at TA=25°C.

Symbol	Parameter	Device	Type.	Max.	Units	Test Conditions
λ_{peak}	Peak Wavelength	Yellow Green Yellow Orange Red Super Red Bright Red	570 585 630 660 700		nm	IF-20mA
λ_D	Dominate Wavelength	Yellow Green Yellow Orange Red Super Red Bright Red	560 580 610 640 690		nm	IF-20mA
$\Delta \lambda_{1/2}$	Spectral Line Halfwit	Yellow Green Yellow Orange Red Super Red Bright Red	30 35 45 20 45		nm	IF-20mA
C	Capacitance	Yellow Green Yellow Orange Red Super Red Bright Red	15 20 15 45 40		pF	VF=0V; f=1MHZ
VF	Forward Voltage	Yellow Green Yellow Orange Red Super Red Bright Red	2.1 2.0 2.0 1.7 2.1	2.8 2.8 2.8 2.8 2.8	V	IF-20mA
IR	Reverse Current	All		10	uA	VR=5V

Absolute Maximum Ratings at TA=25°C.

Parameter	Yellow Green	Yellow	Orange Red	Super Red	Bright Red	Units
Power dissipation	100	85	100	110	45	mW
DC Forward Current	25	25	25	25	25	mA
Peak Forward Current	160	160	160	200	50	mA
Reverse Voltage	5	5	5	5	5	V

NOTES:

1. Operating temperature: 40°C. TO 80°C.
2. Lead soldering: 260°C for 5 seconds.