



RLU4116E

- **Ultra Violet Radiation Source**
- **375 nm**
- **70 mW**
- **5.6mm TO, integrated PD**



Description

LD-375-70MG is an Ultra Violet Laser Diode emitting at 375 nm with rated output power of 70 mW in standard 5.6mm TO package. It features integrated photo diode and ESD protection circuit.

Maximum Ratings

Parameter	Symbol	Values		Unit
		Min.	Max.	
Optical Output Power	P_O		85	mW
PD Reverse Voltage	$V_R (PD)$		5	V
Reverse Current	I_R		85	mA
Operating Temperature	T_{CASE}	+ 10	+ 40	°C
Storage Temperature	T_{STG}	- 40	+ 85	°C
Soldering Temperature	T_{SOLDER}		260	°C

Laser Characteristics ($T_{CASE} = 25^\circ C, P_O = 70 \text{ mW}$)

Parameter	Symbol	Min.	Values		Unit
			Typ.	Max.	
Emission Wavelength	λ_{peak}	370	-	380	nm
Optical Output Power	P_O			70	mW
Spectral Width	$\Delta\lambda$		2		nm
Threshold Current	I_{th}		50	75	mA
Operating Current	I_F		110	140	mA
Operating Voltage	V_F		5.4	6.0	V
Beam Divergence (FWHM)	$\theta_{ } \times \theta_{\perp}$	6x19	9x22.5	11x26	deg.
Beam Pointing Accuracy (FWHM)	$\Delta\theta_{ } / \Delta\theta_{\perp}$	- 3 / -3	-	3 / 3	deg.
Slope Efficiency	η	0.9	1.2		W/A
Monitor Current*	I_m	0.05	0.2	2.0	mA

*Monitor current is short term power reference only. Not guaranteed for accuracy.



Performance Characteristics

Output Power vs. Forward Current

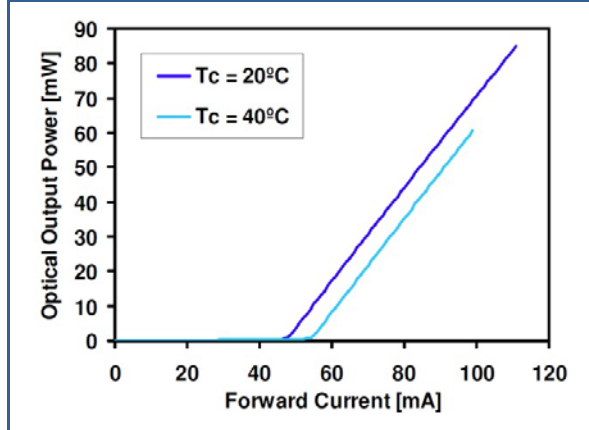

Forward Voltage vs. Forward Current

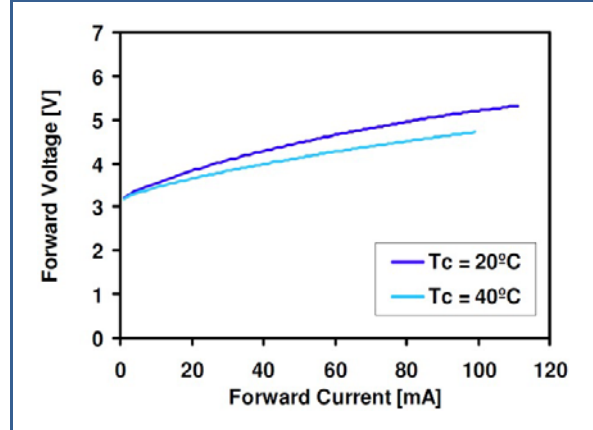

Output Power vs. Case Temperature

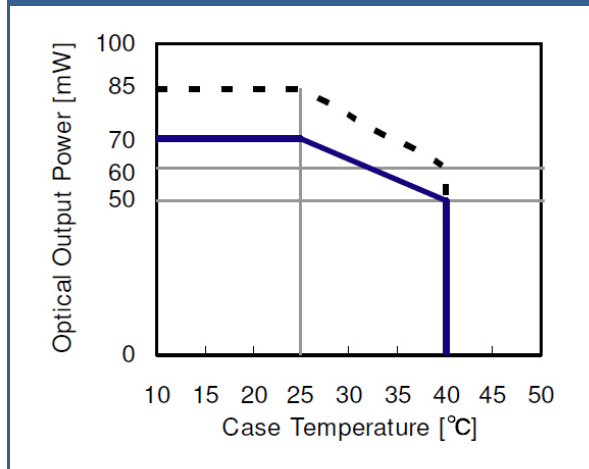

Peak Wavelength vs. Case Temperature

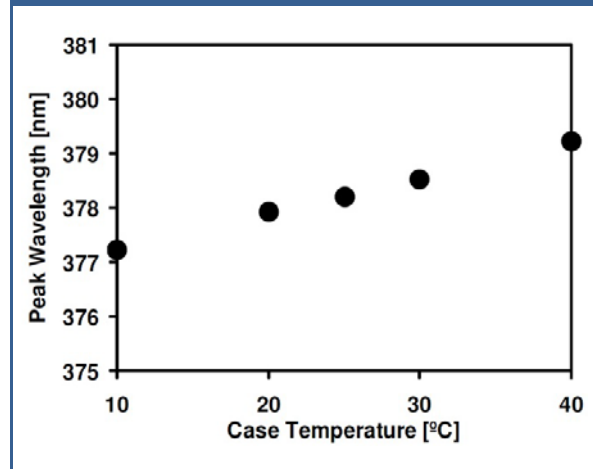

Far Field Pattern

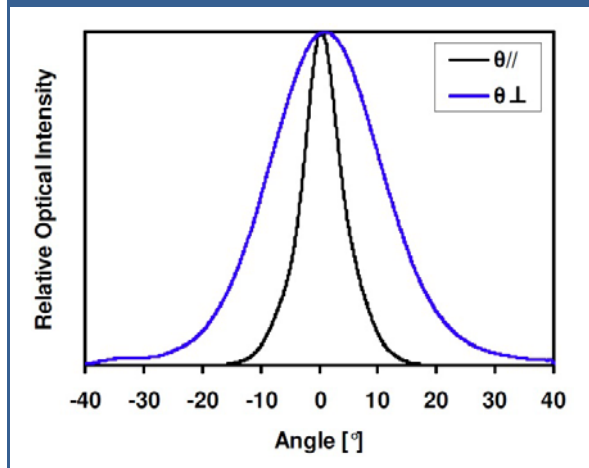

Spectrum

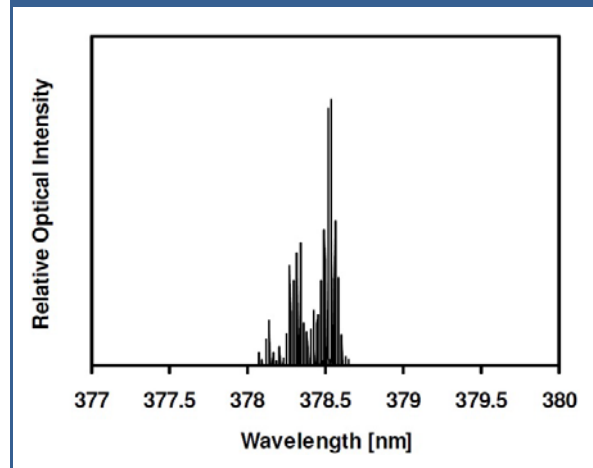



Drawing

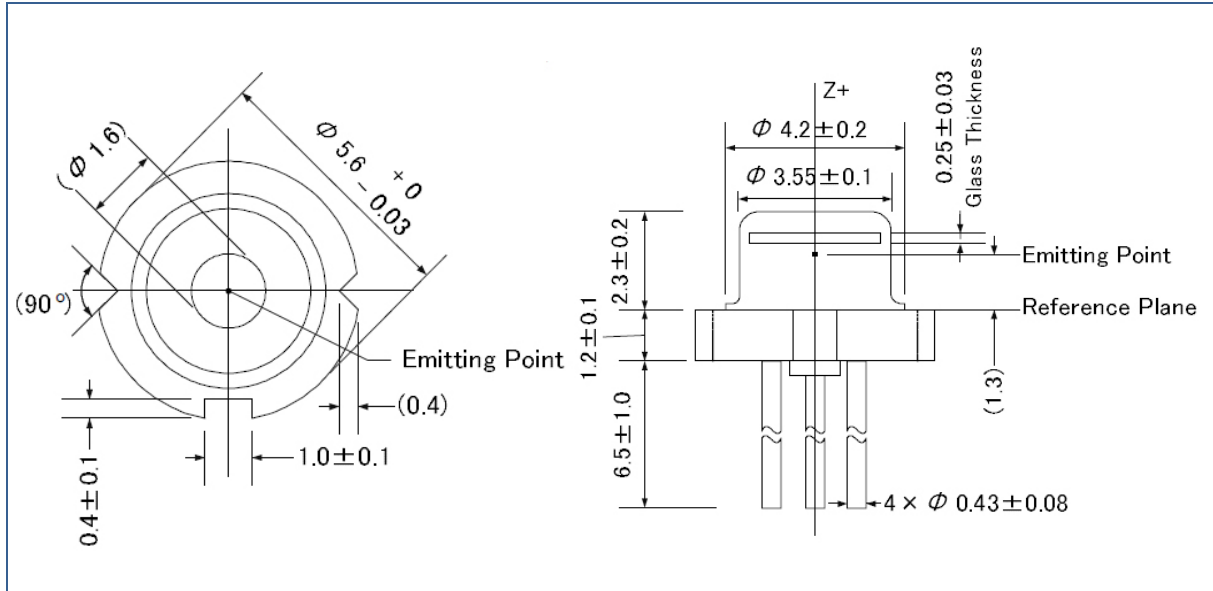

Dimensions in mm

Electrical Connection

Lead	Description
Pin 1	LD Anode
Pin 2	LD Cathode
Pin 3	PD Cathode
Pin 4	PD Anode

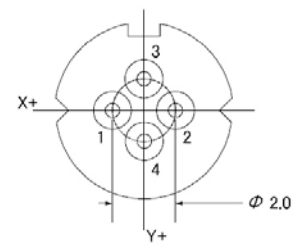
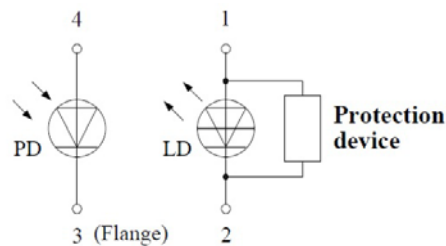

View from below, dimensions in mm



Mounting Instruction

In order to maintain lifetime and stability of the laser diode it is essential to provide efficient heat management. Heat dissipation is possible through the base plate only. For long time stable operation proper contact between laser diode base plate and heat sink is mandatory



Safety Advice

This laser diode emits highly concentrated ultra violet light which can be **hazardous to the human eye**. This diode is classified as **Class 3B laser product** according to **IEC 60825-1** and **21 CFR Part 1040.10 Safety Standards**. Actual laser light emitted and precautions necessary strongly depend on mode of operation.



This product is comply with 21 CFR Part 1040.10

© All Rights Reserved

The above specifications are for reference purpose only and subjected to change without prior notice