

◆DESCRIPTION

The Ramaxel RMT3160EB68FAW-1600 memory module family are low profile Unbuffered SODIMM modules with 30.00mm height based DDR3 technology. DIMMs are available as No-ECC (x64) modules.

The module family based on 16(x64) x8 DDR3L DRAM components, and the DIMMs feature serial presence detect based on a serial EEPROM device.

◆FEATURE

- 204-pin Dual-in-line DDR3L memory module.
- JEDEC Standard with 1.35V & 1.5 V (± 0.075 V) power supply
- 2 Ranks Organizations based x8 DDR3L DRAM components
- Fast data transfer rates: PC3(L)-12800
- Differential data strobe (DQS, DQS#) option
- Differential clock inputs (CK,CK#)
- Commands entered on each rising CK edge
- Eight-bit pre-fetch architecture
- DQS edge-aligned with data for READs
- DQS center-aligned with data for WRITEs
- DLL to align DQ and DQS transitions with CK
- Data mask (DM) for masking write data
- Programmable burst lengths: 4 or 8
- Adjustable data-output drive strength
- Concurrent auto pre-charge option is supported
- Auto Refresh (CBR) and Self Refresh Mode
- ZQ calibration
- On-die termination (ODT)
- Serial Presence Detect (SPD) with EEPROM
- Gold edge contacts
- For contact pads, electrolytic gold plating 0.76 micrometer minimum.
- Halogen-free

◆PART NUMBER DECODER

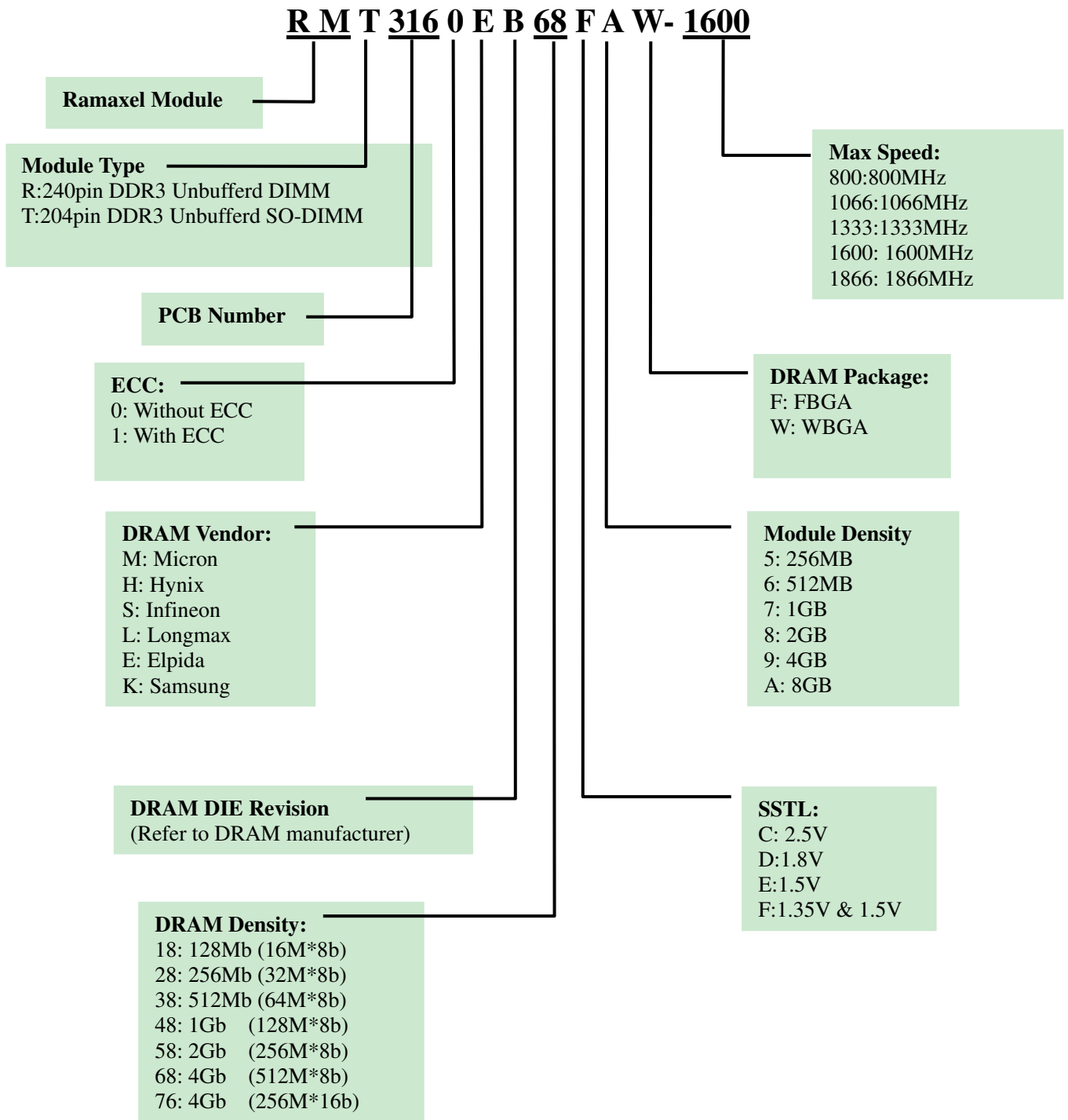

◆ PINOUT, PIN LOCATION and FUNCTIONAL DESCRIPTION

PINOUT

Pin	Front	Pin	Back	Pin	Front	Pin	Back	Pin	Front	Pin	Back	Pin	Front	Pin	Back
1	VREFDQ	2	VSS	53	DQ19	54	VSS	105	VDD	106	VDD	157	DQ42	158	DQ46
3	VSS	4	DQ4	55	VSS	56	DQ28	107	A10/AP	108	BA1	159	DQ43	160	DQ47
5	DQ0	6	DQ5	57	DQ24	58	DQ29	109	BA0	110	RFU	161	VSS	162	VSS
7	DQ1	8	VSS	59	DQ25	60	VSS	111	VDD	112	VDD	163	DQ48	164	DQ52
9	VSS	10	DQS0	61	VSS	62	DQS3	113	WE	114	CS0	165	DQ49	166	DQ53
11	DM0	12	DQS0	63	DM3	64	DQS3	115	CAS	116	ODT0	167	VSS	168	VSS
13	VSS	14	VSS	65	VSS	66	VSS	117	VDD	118	VDD	169	DQS6	170	DM6
15	DQ2	16	DQ6	67	DQ26	68	DQ30	119	A13 ³	120	ODT1	171	DQS6	172	VSS
17	DQ3	18	DQ7	69	DQ27	70	DQ31	121	CS1	122	NC ¹	173	VSS	174	DQ54
19	VSS	20	VSS	71	VSS	72	VSS	123	VDD	124	VDD	175	DQ50	176	DQ55
21	DQ8	22	DQ12	73	CKE0	74	CKE1	125	TEST ²	126	VREFCA	177	DQ51	178	VSS
23	DQ9	24	DQ13	75	VDD	76	VDD	127	VSS	128	VSS	179	VSS	180	DQ60
25	VSS	26	VSS	77	NC ¹	78	A15 ³	129	DQ32	130	DQ36	181	DQ56	182	DQ61
27	DQS1	28	DM1	79	BA2	80	A14 ³	131	DQ33	132	DQ37	183	DQ57	184	VSS
29	DQS1	30	RESET	81	VDD	82	VDD	133	VSS	134	VSS	185	VSS	186	DQ60
31	VSS	32	VSS	83	A12/EC	84	A11	135	DQS4	136	DM4	187	DM7	188	DQ61
33	DQ10	34	DQ14	85	A9	86	A7	137	DQS4	138	VSS	189	VSS	190	VSS
35	DQ11	36	DQ15	87	VDD	88	VDD	139	VSS	140	DQ38	191	DQ58	192	DQ62
37	VSS	38	VSS	89	A8	90	A6	141	DQ34	142	DQ39	193	DQ59	194	DQ63
39	DQ16	40	DQ20	91	A5	92	A4	143	DQ35	144	VSS	195	VSS	196	VSS
41	DQ17	42	DQ21	93	VDD	94	VDD	145	VSS	146	DQ44	197	SA0	198	EVENT
43	VSS	44	VSS	95	A3	96	A2	147	DQ40	148	DQ45	199	VDDSPD	200	SDA
45	DQS2	46	DM2	97	A1	98	A0	149	DQ41	150	VSS	201	SA1	202	SCL
47	DQS2	48	VSS	99	VDD	100	VDD	151	VSS	152	DQS5	203	VTT	204	VTT
49	VSS	50	DQ22	101	CK0	102	CK1	153	DM5	154	DQS5				
51	DQ18	52	DQ23	103	CK0	104	CK1	155	VSS	156	VSS				

Notes

1. NC = No Connect, NU = Not Useable, RFU = Reserved Future Use.
2. TEST(Pin 125) is reserved for bus analysis probes and is NC on normal memory modules.
3. This address might be connected to NC balls of the DRAMs(depending on density); either way they will be connected to the termination resistor.

◆ FUNCTIONAL DESCRIPTION

Symbol	Type	Polarity	Function
CK0/ $\overline{CK0}$ CK1/ $\overline{CK1}$	Input	Cross point	The system clock inputs. All address and command lines are sampled on the cross point of the rising edge of CK and falling edge of \overline{CK} . A Delay Locked Loop (DLL) circuit is driven from the clock inputs and output timing for read operations is synchronized to the input clock.
CKE[0:1]	Input	Active High	Activates the DDR3 SDRAM CK signal when high and deactivates the CK signal when low. By deactivating the clocks, CKE low initiates the Power Down mode or the Self Refresh mode.
\overline{CS} [1:0]	Input	Active Low	Enables the associated DDR3 SDRAM command decoder when low and disables the command decoder when high. When the command decoder is disabled, new commands are ignored but previous operations continue, Rank0 is selected by $\overline{CS}0$; Rank1 is selected by $\overline{CS}1$
\overline{RAS} , \overline{CAS} , \overline{WE}	Input	Active Low	When sampled at the positive rising edge of CK and falling edge of \overline{CK} , signals \overline{RAS} , \overline{CAS} , \overline{WE} define the operation to be executed by the SDRAM.
ODT[0:1]	Input	Active High	Asserts on-die termination for DQ, DM, DQS, and \overline{DQS} signals if enabled via the DDR3 SDRAM mode register.
DM[0:7]	Input	Active High	The data write masks, associated with one data byte. In Write mode, DM operates as a byte mask by allowing input data to be written if it is low but blocks the write operation if it is high. In Read mode, DM lines have no effect.
DQS[0:7] \overline{DQS} [0:7]	I/O	Cross point	The data strobes, associated with one data byte, sourced with data transfers. In Write mode, the data strobe is sourced by the controller and is centered in the data window. In Read mode, the data strobe is sourced by the DDR3 SDRAMs and is sent at the leading edge of the data window. \overline{DQS} signals are complements, and timing is relative to the cross point of respective DQS and \overline{DQS} .
BA[0:2]	Input	-	Selects which DDR3 SDRAM internal bank of four or eight is activated.
A0 ~ A9 A10/AP A11 A12/ \overline{BC} A13 ~ A15	Input	-	During a Bank Activate command cycle, defines the row address when sampled at the cross point of the rising edge of CK and falling edge of \overline{CK} . During a Read or Write command cycle, defines the column address when sampled at the cross point of the rising edge of CK and falling edge of \overline{CK} . In addition to the column address, AP is used to invoke autoprecharge operation at the end of the burst read or write cycle. If AP is high, autoprecharge is selected and BA0-BAn defines the bank to be precharged. If AP is low, autoprecharge is disabled. During a Precharge command cycle, AP is used in conjunction with BA0-BAn to control which bank(s) to precharge. If AP is high, all banks will be precharged regardless of the state of BA0-BAn inputs. If AP is low, then BA0-BAn are used to define which bank to precharge. A12/ \overline{BC} is sampled during READ and WRITE commands to determine if burst chop (on-the-fly) will be performed (HIGH, no burst chop; LOW, burst chopped)
DQ[0:63]	I/O	-	Data Input/Output pins.
VDD, VDDSPD, VSS	Supply	-	Power supplies for core, I/O, Serial Presence Detect, Temp sensor, and ground for the module.
VREFDQ, VREFCA	Supply	-	Reference voltage for inputs.
SDA	I/O	-	This is a bidirectional pin used to transfer data into or out of the SPD EEPROM and temp sensor. A resistor must be connected from the SDA bus line to VDDSPD on the system planar to act as a pull up.
SCL	Input	-	This pin is used to clock data into and out of the SPD EEPROM and Temp sensor. A resistor must be connected from the SCL bus line to VDDSPD on the system planar to act as a pull up
SA[0:2]	Input	-	Address pins used to select the Serial Presence Detect and Temp sensor base address.
TEST	I/O	-	The TEST pin reserved for bus analysis tools and is not connected on normal memory mouldels(SO-DIMMs).
\overline{EVENT}	Output	Active Low	The \overline{EVENT} pin is reserved for use to flag critical module temperature.
\overline{RESET}	Input	Active Low	This signal resets the DDR3 SDRAM
ZQ	Input	-	Reference pin for ZQ calibration

◆ COMMAND TRUTH TABLE

Function	Abbreviation	CKE		CS#	RAS#	CAS#	WE#	BA0-BA3	A13-A15	A12-BC#	A10-AP	A0-A9, A11	Notes
		Previous Cycle	Current Cycle										
Mode Register Set	MRS	H	H	L	L	L	L	BA	OP Code				
Refresh	REF	H	H	L	L	L	H	V	V	V	V	V	
Self Refresh Entry	SRE	H	L	L	L	L	H	V	V	V	V	V	7,9,12
Self Refresh Exit	SRX	L	H	H	V	V	V	V	V	V	V	V	7,8,9,12
				L	H	H	H						
Single Bank Precharge	PRE	H	H	L	L	H	L	BA	V	V	L	V	
Precharge all Banks	PREA	H	H	L	L	H	L	V	V	V	H	V	
Bank Activate	ACT	H	H	L	L	H	H	BA	Row Address (RA)				
Write (Fixed BL8 or BC4)	WR	H	H	L	H	L	L	BA	RFU	V	L	CA	
Write (BC4, on the Fly)	WRS4	H	H	L	H	L	L	BA	RFU	L	L	CA	
Write (BL8, on the Fly)	WRS8	H	H	L	H	L	L	BA	RFU	H	L	CA	
Write with Auto Precharge (Fixed BL8 or BC4)	WRA	H	H	L	H	L	L	BA	RFU	V	H	CA	
Write with Auto Precharge (BL4, on the Fly)	WRAS4	H	H	L	H	L	L	BA	RFU	L	H	CA	
Write with Auto Precharge (BL8, on the Fly)	WRAS8	H	H	L	H	L	L	BA	RFU	H	H	CA	
Read (Fixed BL8 or BC4)	RD	H	H	L	H	L	H	BA	RFU	V	L	CA	
Read (BC4, on the Fly)	RDS4	H	H	L	H	L	H	BA	RFU	L	L	CA	
Read (BL8, on the Fly)	RDS8	H	H	L	H	L	H	BA	RFU	H	L	CA	
Read with Auto Precharge (Fixed BL8 or BC4)	RDA	H	H	L	H	L	H	BA	RFU	V	H	CA	
Read with Auto Precharge (BC4, on the Fly)	RDAS4	H	H	L	H	L	H	BA	RFU	L	H	CA	
Read with Auto Precharge (BL8, on the Fly)	RDAS8	H	H	L	H	L	H	BA	RFU	H	H	CA	
No Operation	NOP	H	H	L	H	H	H	V	V	V	V	V	10
Device Deselected	DES	H	H	H	X	X	X	X	X	X	X	X	11
Power Down Entry	PDE	H	L	L	H	H	H	V	V	V	V	V	6,12
				H	V	V	V						
Power Down Exit	PDX	L	H	L	H	H	H	V	V	V	V	V	6,12
				H	V	V	V						
ZQ Calibration Long	ZQCL	H	H	L	H	H	L	X	X	X	H	X	

Function	Abbreviation	CKE		CS#	RAS#	CAS#	WE#	BA0-BA3	A13-A15	A12-BC#	A10-AP	A0-A9, A11	Notes
		Previous Cycle	Current Cycle										
ZQ Calibration Short	ZQCS	H	H	L	H	H	L	X	X	X	L	X	
Notes: 1. All DDR3 SDRAM commands are defined by states of CS#, RAS#, CAS#, WE# and CKE at the rising edge of the clock. The MSB of BA, RA and CA are device density and configuration dependant. 2. RESET# is Low enable command which will be used only for asynchronous reset so must be maintained HIGH during any function. 3. Bank addresses (BA) determine which bank is to be operated upon. For (E)MRS BA selects an (Extended) Mode Register. 4. "V" means "H or L (but a defined logic level)" and "X" means either "defined or undefined (like floating) logic level". 5. Burst reads or writes cannot be terminated or interrupted and Fixed/on-the-Fly BL will be defined by MRS. 6. The Power Down Mode does not perform any refresh operation. 7. The state of ODT does not affect the states described in this table. The ODT function is not available during Self Refresh. 8. Self Refresh Exit is asynchronous. 9. VREF(Both VrefDQ and VrefCA) must be maintained during Self Refresh operation. 10. The No Operation command should be used in cases when the DDR3 SDRAM is in an idle or wait state. The purpose of the No Operation command (NOP) is to prevent the DDR3 SDRAM from registering any unwanted commands between operations. A No Operation command will not terminate a previous operation that is still executing, such as a burst read or write cycle. 11. The Deselect command performs the same function as No Operation command. 12. Refer to the CKE Truth Table for more detail with CKE transition.													

◆BLOCK DIAGRAM

Block Diagram: Raw Card Version F(Populated as 2ranks of x8 SDRAMs)

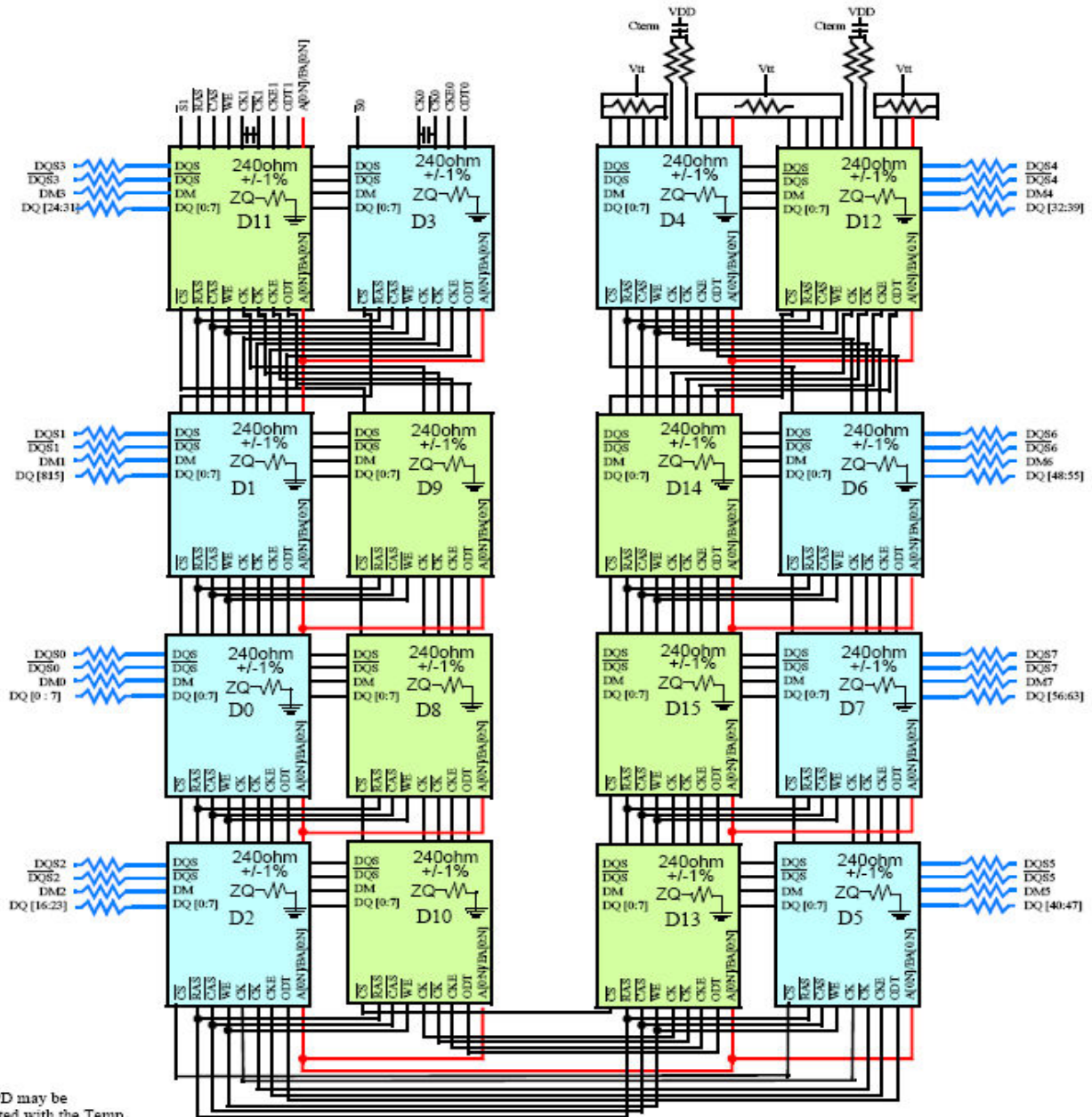

The SPD may be integrated with the Temp Sensor or may be a separate component.

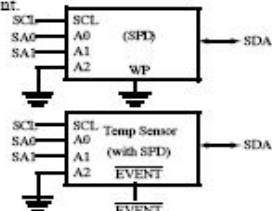

NOTES
1. DQ wiring may differ from that shown however, DQ, DM, DQS, and DQS relationships are maintained as shown

Rank 0
Rank 1

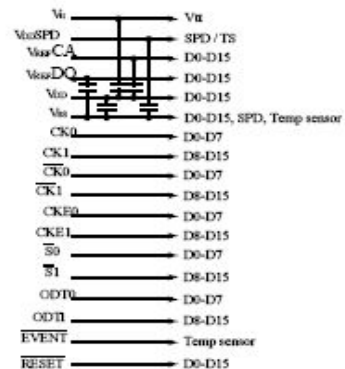
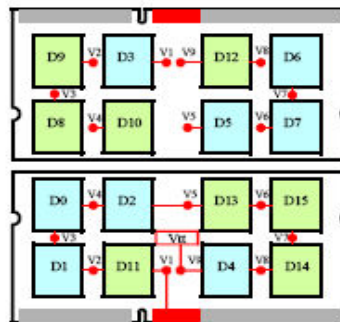

◆ ABSOLUTE MAXIMUM RATING

Symbol	Parameter	Rating	Units	Notes
VDD	Voltage on VDD pin relative to Vss	-0.4 V ~ 1.975 V	V	1,3
VDDQ	Voltage on VDDQ pin relative to Vss	-0.4 V ~ 1.975 V	V	1,3
V _{IN} , V _{OUT}	Voltage on any pin relative to Vss	-0.4 V ~ 1.975 V	V	1
T _{STG}	Storage Temperature	-55 to +100	°C	1,2
Notes: 1. Stresses greater than those listed under "Absolute Maximum Ratings" may cause permanent damage to the device. This is a stress rating only and functional operation of the device at these or any other conditions above those indicated in the operational sections of this specification is not implied. Exposure to absolute maximum rating conditions for extended periods may affect reliability				
2. Storage Temperature is the case surface temperature on the center/top side of the DRAM. For the measurement conditions, please refer to JEDEC51-2 standard.				
3. VDD and VDDQ must be within 300 mV of each other at all times; and VREF must be not greater than 0.6 x VDDQ. When VDD and VDDQ are less than 500 mV; VREF may be equal to or less than 300 mV				

◆ OPERATING TEMPERATURE and DC/AC OPERATING CONDITION

OPERATING TEMPERATURE

Parameter	Symbol	Rating	Units	Notes
Operating case temperature	TC	0 to +95	°C	1, 2, 3
Notes:				
1. Operating temperature is the case surface temperature on the center/top side of the DRAM.				
2. The Normal Temperature Range specifies the temperatures where all DRAM specifications will be supported. During operation, the DRAM case temperature must be maintained between 0° C to +85° C under all operating conditions.				
3. Some applications require operation of the DRAM in the Extended Temperature Range between +85° C and +95° C case temperature. Full specifications are guaranteed in this range, but the following additional conditions apply:				
a) Refresh commands must be doubled in frequency, therefore reducing the refresh interval tREFI to 3.9µs. (This double refresh requirement may not apply for some devices.)				
b) If Self-refresh operation is required in the Extended Temperature Range, then it is mandatory to either use the Manual Self-Refresh mode with Extended Temperature Range capability (MR2 bit [A6, A7] = [0, 1]) or enable the optional Auto Self-Refresh mode (MR2 bit [A6, A7] = [1, 0]).				

Note: Operating Temperature TOPER is the case surface temperature on the center / top side of the DRAM for measurement conditions.

DC/AC OPERATING CONDITION

Recommended DC Operating Conditions - DDR3L (1.35V) operation

Symbol	Parameter/Condition	Min	Typ	Max	Units	Notes
VDD	Supply voltage	1.283	1.35	1.45	V	1,2,3,4
VDDQ	Supply voltage for Output	1.283	1.35	1.45	V	1,2,3,4

NOTE 1 Maximum DC value may not be greater than 1.425V. The DC value is the linear average of VDD/VDDQ(t) over a very long period of time (e.g., 1 sec).

NOTE 2 If maximum limit is exceeded, input levels shall be governed by DDR3 specifications.

NOTE 3 Under these supply voltages, the device operates to this DDR3L specification.

NOTE 4 Once initialized for DDR3L operation, DDR3 operation may only be used if the device is in reset while VDD and VDDQ are changed for DDR3 operation.

Recommended DC Operating Conditions - DDR3 (1.5V) operation

Symbol	Parameter/Condition	Min	Typ	Max	Units	Notes
VDD	Supply voltage	1.425	1.5	1.575	V	1,2,3
VDDQ	Supply voltage for Output	1.425	1.5	1.575	V	1,2,3

NOTE 1 If minimum limit is exceeded, input levels shall be governed by DDR3L specifications.

NOTE 2 Under 1.5 V operation, this DDR3L device operates to the DDR3 specifications under the same speed timings as defined for this device.

NOTE 3 Once initialized for DDR3 operation, DDR3L operation may only be used if the device is in reset while VDD and VDDQ are changed for DDR3L operation.

Single Ended AC and DC Input Levels for Command and ADDRESS

Symbol	Parameter	DDR3L-800/1066/1333/1600		Unit	Notes
		Min	Max		
VIH.CA(DC100)	DC input logic high	Vref + 0.100	VDD	V	1, 5
VIL.CA(DC100)	DC input logic low	VSS	Vref - 0.100	V	1, 6
VIH.CA(AC175)	AC input logic high	Vref + 0.175	Note2	V	1, 2, 7
VIL.CA(AC175)	AC input logic low	Note2	Vref - 0.175	V	1, 2, 8
VIH.CA(AC150)	AC Input logic high	Vref + 0.150	Note2	V	1, 2, 7
VIL.CA(AC150)	AC input logic low	Note2	Vref - 0.150	V	1, 2, 8
VIH.CA(AC135)	AC input logic high	-	-	V	1, 2, 7
VIL.CA(AC135)	AC input logic low	-	-	V	1, 2, 8
VIH.CA(AC125)	AC Input logic high	-	-	V	1, 2, 7
VIL.CA(AC125)	AC input logic low	-	-	V	1, 2, 8
V _{RefCA(DC)}	Reference Voltage for ADD, CMD inputs	0.49 * VDD	0.51 * VDD	V	3, 4, 9

Notes:

- For input only pins except $\overline{\text{RESET}}$, Vref = VrefCA (DC).
- Refer to "Overshoot and Undershoot Specifications" in the device datasheet.
- The ac peak noise on V_{Ref} may not allow V_{Ref} to deviate from V_{RefCA(DC)} by more than +/-1% VDD (for reference: approx. +/- 15 mV).
- For reference: approx. VDD/2 +/- 15 mV.
- VIH(dc) is used as a simplified symbol for VIH.CA(DC100)
- VIL(dc) is used as a simplified symbol for VIL.CA(DC100)
- VIH(ac) is used as simplified symbol for VIH.CA(AC175), VIH.CA(AC150), VIH.CA(AC135), and VIH.CA(AC125); VIH.CA(AC175) value is used when Vref + 0.175V is referenced, VIH.CA(AC150) value is used when Vref + 0.150V is referenced, VIH.CA(AC135) value is used when Vref + 0.135V is referenced, and VIH.CA(AC125) value is used when Vref + 0.125V is referenced.
- VIL(ac) is used as simplified symbol for VIL.CA(AC175), VIL.CA(AC150), VIL.CA(AC135), and VIL.CA(AC125); VIL.CA(AC175) value is used when Vref - 0.175V is referenced, VIL.CA(AC150) value is used when Vref - 0.150V is referenced, VIL.CA(AC135) value is used when Vref - 0.135V is referenced, and VIL.CA(AC125) value is used when Vref - 0.125V is referenced.
- Vref is measured relative to VDD at the same point, time and same device.

Single Ended AC and DC Input Levels for DQ and DM

Symbol	Parameter	DDR3L-800/1066		DDR3L-1333/1600		Unit	Notes
		Min	Max	Min	Max		
VIH.DQ(DC100)	DC input logic high	Vref + 0.100	VDD	Vref + 0.100	VDD	V	1
VIL.DQ(DC100)	DC input logic low	VSS	Vref - 0.100	VSS	Vref - 0.100	V	1
VIH.DQ(AC175)	AC input logic high	Vref + 0.175	Note2	-	-	V	1, 2, 7
VIL.DQ(AC175)	AC input logic low	Note2	Vref - 0.175	-	-	V	1, 2, 8
VIH.DQ(AC150)	AC Input logic high	Vref + 0.150	Note2	Vref + 0.150	Note2	V	1, 2, 7
VIL.DQ(AC150)	AC input logic low	Note2	Vref - 0.150	Note2	Vref - 0.150	V	1, 2, 8
VIH.CA(AC135)	AC input logic high	-	-	-	-	V	1, 2, 7
VIL.CA(AC135)	AC input logic low	-	-	-	-	V	1, 2, 8
V _{RefDQ(DC)}	Reference Voltage for DQ, DM inputs	0.49 * VDD	0.51 * VDD	0.49 * VDD	0.51 * VDD	V	3, 4, 9

Notes:

- Vref = VrefDQ (DC).
- Refer to "Overshoot and Undershoot Specifications" in the device datasheet.
- The ac peak noise on V_{Ref} may not allow V_{Ref} to deviate from V_{RefDQ(DC)} by more than +/-1% VDD (for reference: approx. +/- 15 mV).
- For reference: approx. VDD/2 +/- 15 mV.
- VIH(dc) is used as a simplified symbol for VIH.DQ(DC100)
- VIL(dc) is used as a simplified symbol for VIL.DQ(DC100)
- VIH(ac) is used as simplified symbol for VIH.DQ(AC175), VIH.DQ(AC150), and VIH.DQ(AC135); VIH.DQ(AC175) value is used when Vref + 0.175V is referenced, VIH.DQ(AC150) value is used when Vref + 0.150V is referenced, and VIH.DQ(AC135) value is used when Vref + 0.135V is referenced.
- VIL(ac) is used as simplified symbol for VIL.DQ(AC175), VIL.DQ(AC150), and VIL.DQ(AC135); VIL.DQ(AC175) value is used when Vref - 0.175V is referenced, VIL.DQ(AC150) value is used when Vref - 0.150V is referenced, and VIL.DQ(AC135) value is used when Vref - 0.135V is referenced.
- Vref is measured relative to VDD at the same point, time and same device.

◆ DIMENSIONS (Unit: mm)

Front side

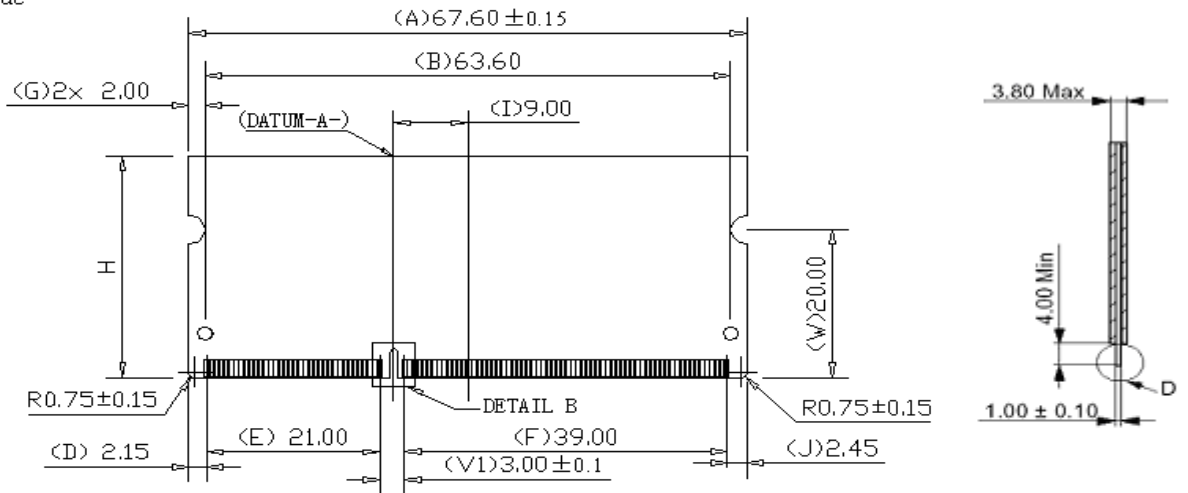

Back side

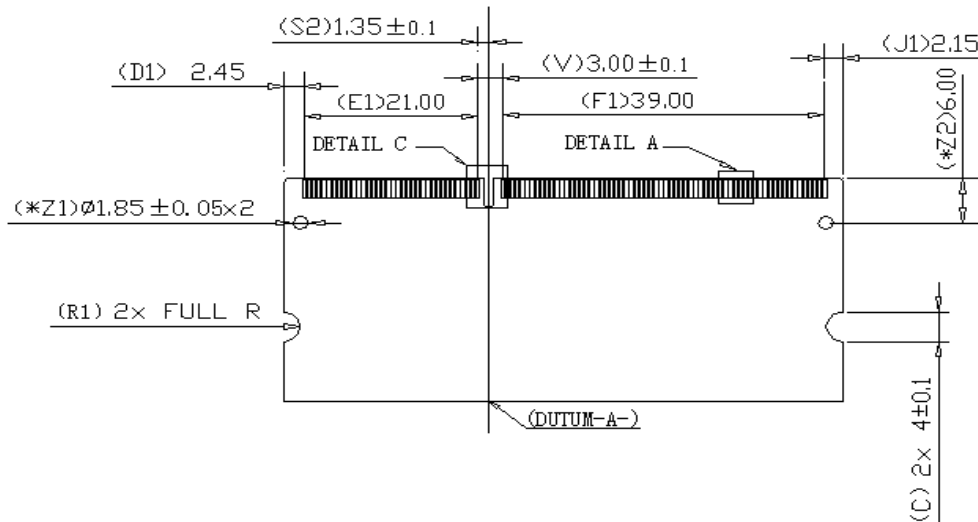

Detail A

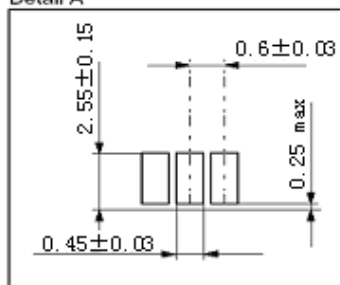

Detail B

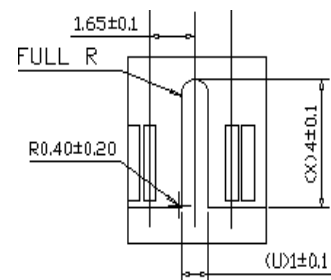
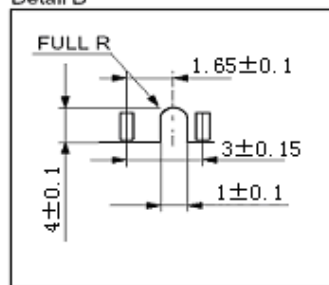

Detail C

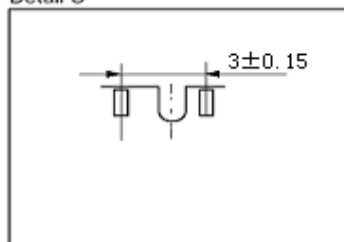

Detail D

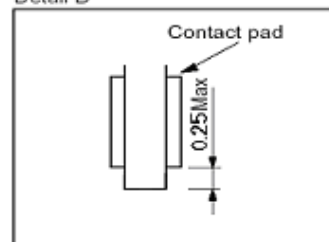

Note: Tolerances on all dimensions +0.15 unless otherwise specified.