

Wirewound/Metal Film Resistors, Commercial Power, Radial Lead

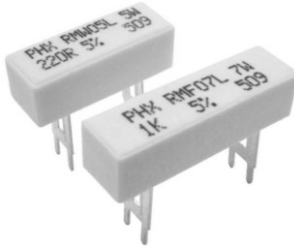

FEATURES

- High power dissipation in small volume
- Low solder spot temperature
- Very stable mounting
- Non-flammable
- High pulse load handling capabilities
- High heat and moisture resistance



RoHS
COMPLIANT

Please reference the Vishay Dale closest equivalents: CPR, CPR High Volume or CPR Special Terminals (for CPR datasheet please visit our website: <http://www.vishay.com/doc?30219>, for CPR High Volume datasheet: <http://www.vishay.com/doc?30261> and for CPR Special Terminals datasheet: <http://www.vishay.com/doc?30257>).

Note:

- There may be slight differences between the Vishay Phoenix and the Vishay Dale crosses

TECHNOLOGY

RMWL: The resistive element is a wire which is wound on a fiber glass core.

RMFL: The resistive element is a metal film resistor consisting of a metal layer deposited over a high grade ceramic rod.

The mounting terminations are crimped to the resistive body to assure good mechanical and electrical contact. To ensure a flexible assembling process, the resistors are offered in various terminals styles, such as long or short, one or two pins in stainless steel for lower solder spot. The resistor body and lead ends are housed within a rectangular ceramic case which is non-flammable, will not melt even at high overloads and is resistant to most commonly used cleaning solvents, in accordance with IEC 60068-2-45.

STANDARD ELECTRICAL SPECIFICATIONS

MODEL	POWER RATING $P_{70^{\circ}\text{C}}$ W	RESISTANCE RANGE ⁽¹⁾ Ω	TOLERANCE ⁽²⁾ %	E-SERIES Decade Values
RMW03L	3	0.22 - 1.5	± 10	24
RMF03L		1.6 - 3.9K	± 5	
RMW05L	5	-	± 10	
RMF05L		100 - 39K	± 5	
RMF05L		0.47 - 1.5	± 10	
RMW07L	7	1.6 - 4.7K	± 5	
RMF07L		-	± 10	
RMF07L		100 - 51K	± 5	
RMW10L	10	0.47 - 1.5	± 10	
RMF10L		1K - 100K	± 5	
RMF10L		0.47 - 1.5	± 10	
RMF10L		1.6 - 10K	± 5	
		-	± 10	
		1K - 150K	± 5	

Notes:

⁽¹⁾ Special resistance values available upon request

⁽²⁾ Other tolerances available upon request

TECHNICAL SPECIFICATIONS

PARAMETER	UNIT	RMWL	RMF03L	RMF05L	RMF07L	RMF10L
Limiting Voltage	V	$\sqrt{P_n} \times R$	750	1000	1200	1500
Insulation Voltage	V	> 2000				
Temperature Coefficient ⁽³⁾	ppm/ $^{\circ}\text{C}$	R < 10 Ω : 0 to 600; R \geq 10 Ω : - 80 to + 140;	± 250			
Operating Temperature	$^{\circ}\text{C}$	- 25 to + 155				
Short Time Overload	-	10 x rated power for 5 s				

Note:

⁽³⁾ Temperature Coefficient of $\pm 30, 50$ or 90 ppm/ $^{\circ}\text{C}$ available on RMW upon request



DIMENSIONS in millimeters (inches)					
			TERMINAL STYLE 1 (SINGLE PIN)	TERMINAL STYLE 2 (DOUBLE PIN)	
TYPE	L	P	W	H1	H2
RMW03L RMF03L	24.0 ± 1.0 (0.95 ± 0.04)	12.5 ± 1.0 (0.49 ± 0.04)	9.0 ± 1.0 (0.36 ± 0.04)	9.0 ± 1.0 (0.36 ± 0.04)	10.0 ± 1.5 (0.40 ± 0.06) or 25.0 ± 1.5 (0.99 ± 0.06)
RMW05L RMF05L	27.0 ± 1.0 (1.06 ± 0.04)	15.0 ± 1.0 (0.59 ± 0.04)	9.5 ± 1.0 (0.38 ± 0.04)	9.5 ± 1.0 (0.38 ± 0.04)	
RMW07L RMF07L	35.0 ± 1.0 (1.38 ± 0.04)	22.5 ± 1.0 (0.89 ± 0.04)	9.5 ± 1.0 (0.38 ± 0.04)	9.5 ± 1.0 (0.38 ± 0.04)	
RMW10L RMF10L	48.0 ± 1.0 (1.89 ± 0.04)	35.0 ± 1.0 (1.38 ± 0.04)	9.5 ± 1.0 (0.38 ± 0.04)	9.5 ± 1.0 (0.38 ± 0.04)	

OTHER DIMENSIONS in millimeters (inches)			
a	0.4 ± 0.02 (0.02 ± 0.008)	g	7.3 ± 0.30 (0.29 ± 0.012)
b	5.0 ± 0.50 (0.20 ± 0.020)	h	1.5 ± 0.10 (0.06 ± 0.004)
c	7.3 ± 0.30 (0.29 ± 0.012)	i	1.4 ± 0.10 (0.06 ± 0.004)
d	1.5 ± 0.10 (0.06 ± 0.004)	j	5.0 ± 0.10 (0.20 ± 0.004)
e	1.4 ± 0.10 (0.06 ± 0.004)	k	4.5 ± 0.20 (0.80 ± 0.008)
f	4.5 ± 0.20 (0.18 ± 0.008)		

ELECTRICAL CHARACTERISTICS

The power that the resistor can dissipate depends on the operating temperature.

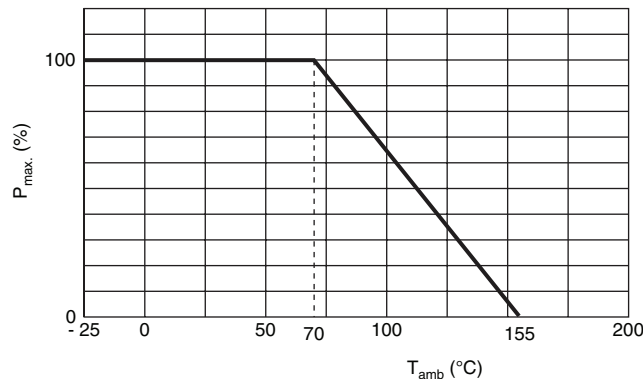

DERATING

Maximum dissipation (P_{max}) in percentage of rated power as a function of ambient temperature (T_{amb})

APPLICATION INFORMATION

The temperature rise of terminal (solder spot) and resistor body (hot spot) as a function of load for terminal styles 1 and 2.

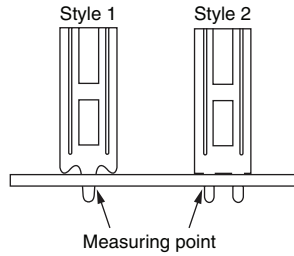

TERMINAL STYLE 1 (ONE PIN)

SOLDER SPOT

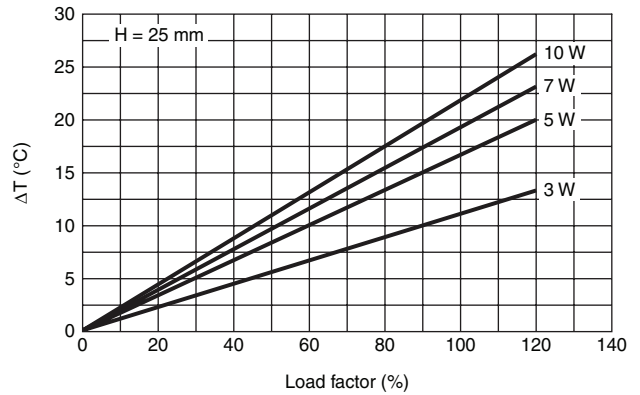
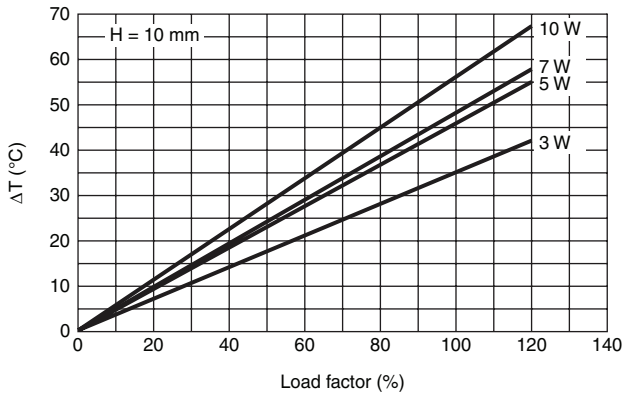

HOT SPOT

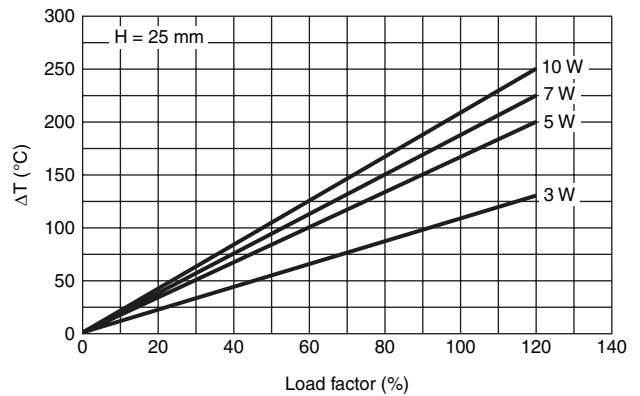
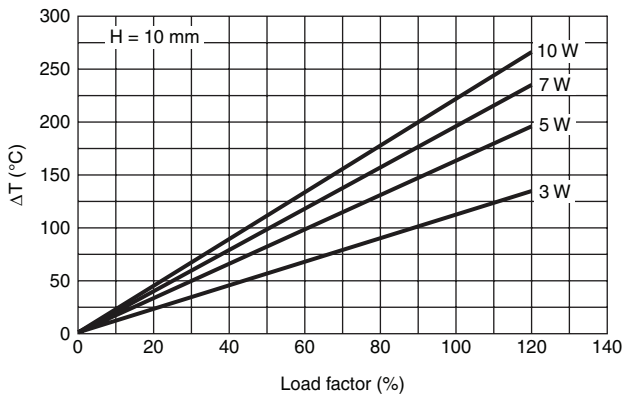



TERMINAL STYLE 2 (TWO PINS)

SOLDER SPOT

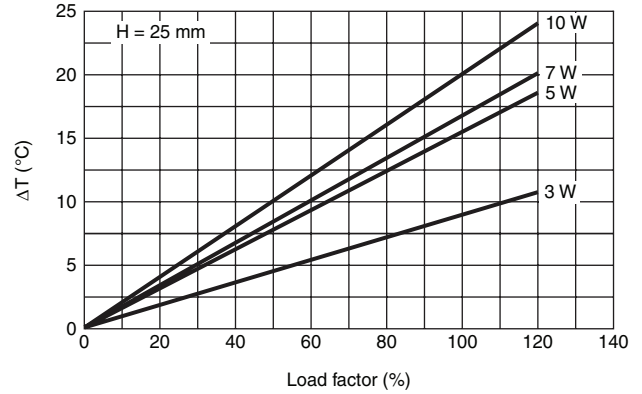
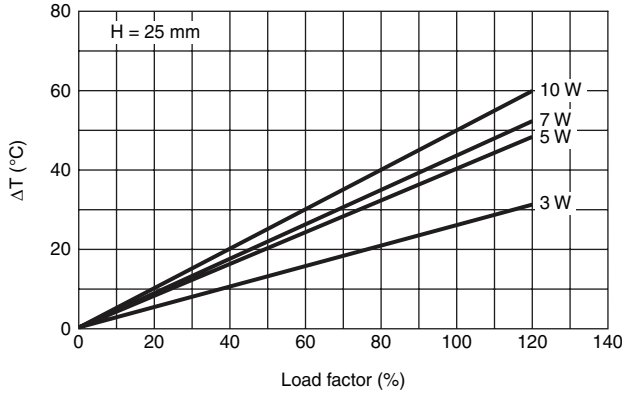

HOT SPOT

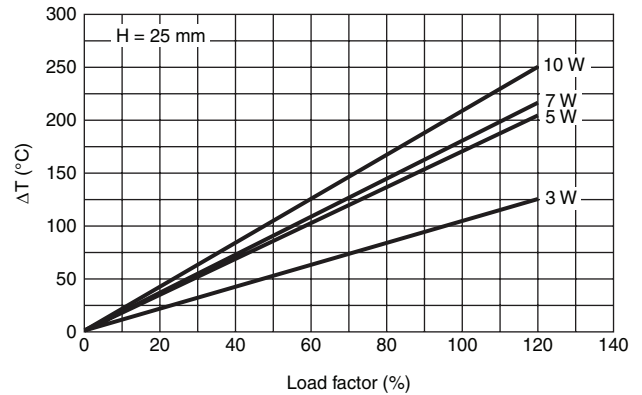
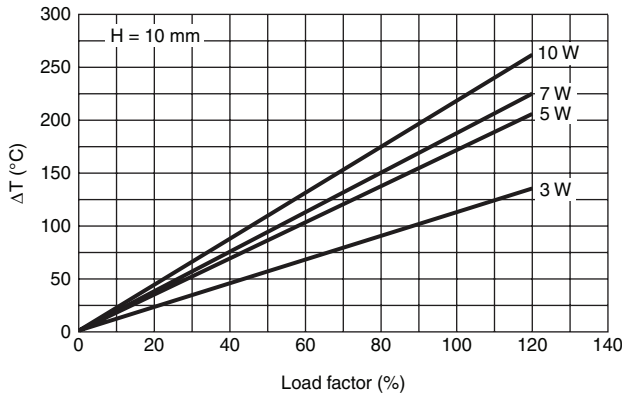

Notes:

Application information available on request:

- Pulse load behavior
- High frequency behavior (self inductance)

MARKING

The resistor is marked with the its type designation. The nominal resistance, the tolerance, the rated dissipation at $T_{amb} = 70\text{ }^{\circ}\text{C}$ and the production date (week and year), are printed in red on the resistor body. For values up to $910\ \Omega$ the R is used as a decimal point. For values of $1000\ \Omega$ or higher the letter K is used a decimal point.

Example:

PHX	RMW07L	7 W
2R2	5 %	221



ORDERING CODE NUMBER

The ordering code is indicating resistor type style/length of terminal and ohmic value.

2 3 2 2 2 5 X X X X X

PRODUCT TYPE	CODE	TYPE OF TERMINAL	CODE	TERMINAL LENGTH	CODE	OHMIC VALUE	RESISTANCE DECADE	LAST DIGIT
RMW03L	0	Style 1	3	10.0 mm (0.40")	1		0.22 Ω - 0.91 Ω	7
RMW05L	1	Style 2	4				1 Ω - 9.1 Ω	8
RMW07L	2						10 Ω - 91 Ω	9
RMW10L	3			25.0 mm (0.98")	2		100 Ω - 910 Ω	1
RMF03L	6						1 kΩ - 9.1 kΩ	2
RMF05L	7						10 kΩ - 91 kΩ	3
RMF07L	8						100 kΩ - 150 kΩ	4
RMF10L	9							

NAFTA ORDERING CODE NUMBER

The resistor have on ordering code with 18 digits, first 5 digits for product type and the subsequent digits indicate the resistance value, tolerance and terminal style.

R M W 0 5 W 4 7 R 0 0 J 2 5 S 2 S S

PRODUCT TYPES	POWER	CODE	VALUE	5 DIGITS	TOLERANCES	CODE	TERMINAL STYLES FOR 3 W UP TO 10 W	CODE	TERMINAL STAINLESS STEEL	CODE
RMW or RMF	3 W	03W	1 Ω	1R000	10 %	K	Terminal height 10 mm (0.394") one pin	10S1	SS	
	5 W	05W	10 Ω	10R00	5 %	J	Terminal height 10 mm (0.394") two pins	10S2		
	7 W	07W	100 Ω	100R0			Terminal height 25 mm (0.984") one pin	25S1		
	10 W	10W	1 kΩ	1K000			Terminal height 25 mm (0.984") two pins	25S2		
			10 kΩ	10K00						
	100 kΩ	100K0								



NAFTA ORDERING INFORMATION				
PRODUCT	TOLERANCE	NAFTA ORDERING CODE	PACKAGING	QUANTITY (pieces)
RMW03L	± 10 %	RMW03WxxxxxK10S1SS	BOX	500
	± 5 %	RMW03WxxxxxJ10S1SS		
	± 10 %	RMW03WxxxxxK25S1SS		
	± 5 %	RMW03WxxxxxJ25S1SS		
	± 10 %	RMW03WxxxxxK10S2SS		
	± 5 %	RMW03WxxxxxJ10S2SS		
	± 10 %	RMW03WxxxxxK25S2SS		
	± 5 %	RMW03WxxxxxJ25S2SS		
RMF03L	± 5 %	RMF03WxxxxxJ10S1SS		
		RMF03WxxxxxJ25S1SS		
		RMF03WxxxxxJ10S2SS		
		RMF03WxxxxxJ25S2SS		
RMW05L	± 10 %	RMW05WxxxxxK10S1SS		
	± 5 %	RMW05WxxxxxJ10S1SS		
	± 10 %	RMW05WxxxxxK25S1SS		
	± 5 %	RMW05WxxxxxJ25S1SS		
	± 10 %	RMW05WxxxxxK10S2SS		
	± 5 %	RMW05WxxxxxJ10S2SS		
	± 10 %	RMW05WxxxxxK25S2SS		
	± 5 %	RMW05WxxxxxJ25S2SS		
RMF05L	± 5 %	RMF05WxxxxxJ10S1SS		
		RMF05WxxxxxJ25S1SS		
		RMF05WxxxxxJ10S2SS		
		RMF05WxxxxxJ25S2SS		
RMW07L	± 10 %	RMW07WxxxxxK10S1SS		
	± 5 %	RMW07WxxxxxJ10S1SS		
	± 10 %	RMW07WxxxxxK25S1SS		
	± 5 %	RMW07WxxxxxJ25S1SS		
	± 10 %	RMW07WxxxxxK10S2SS		
	± 5 %	RMW07WxxxxxJ10S2SS		
	± 10 %	RMW07WxxxxxK25S2SS		
	± 5 %	RMW07WxxxxxJ25S2SS		
RMF07L	± 5 %	RMF07WxxxxxJ10S1SS		
		RMF07WxxxxxJ25S1SS		
		RMF07WxxxxxJ10S2SS		
		RMF07WxxxxxJ25S2SS		
RMW10L	± 10 %	RMW10WxxxxxK10S1SS		
	± 5 %	RMW10WxxxxxJ10S1SS		
	± 10 %	RMW10WxxxxxK25S1SS		
	± 5 %	RMW10WxxxxxJ25S1SS		
	± 10 %	RMW10WxxxxxK10S2SS		
	± 5 %	RMW10WxxxxxJ10S2SS		
	± 10 %	RMW10WxxxxxK25S2SS		
	± 5 %	RMW10WxxxxxJ25S2SS		
RMF10L	± 5 %	RMF10WxxxxxJ10S1SS		
		RMF10WxxxxxJ25S1SS		
		RMF10WxxxxxJ10S2SS		
		RMF10WxxxxxJ25S2SS		
RMW10L	± 10 %	RMW10WxxxxxK10S1SS	400	
	± 5 %	RMW10WxxxxxJ10S1SS		
	± 10 %	RMW10WxxxxxK25S1SS		
	± 5 %	RMW10WxxxxxJ25S1SS		
	± 10 %	RMW10WxxxxxK10S2SS		
	± 5 %	RMW10WxxxxxJ10S2SS		
	± 10 %	RMW10WxxxxxK25S2SS		
	± 5 %	RMW10WxxxxxJ25S2SS		



Composition of Ohmic Value

VALUE	5 DIGITS
1 Ω	1R000
10 Ω	10R00
100 Ω	100R0
1 kΩ	1K000
10 kΩ	10K00
100 kΩ	100K0
1 MΩ	1M000

The ohmic value in the NAFTA ordering code (see table NAFTA ORDERING INFORMATION) is represented by the “xxxxx” in the middle of the above ordering code. The table “Composition of Ohmic Value” gives some examples on how to use these 5 digits.

Example:

RMW05L, 47 Ω, 5 %, terminal 25 mm, two pins is
RMW05W47R00J25S2SS

PACKAGING in millimeters (inches)				
PRODUCT TYPE	P	M	N	QUANTITY (pieces)
RMW03L RMF03L	310 (12.2)	200 (7.9)	190 (7.5)	500
RMW05L RMF05L	310 (12.2)	200 (7.9)	190 (7.5)	
RMW07L RMF07L	300 (11.8)	250 (9.9)	215 (8.5)	
RMW10L RMF10L	300 (11.8)	250 (9.9)	215 (8.5)	400



TESTS AND REQUIREMENTS

Essentially all tests are carried out in accordance with the schedule of IEC publications 60115-1, category 25/155/56 (rated temperature range - 25 °C to + 155 °C; damp heat, long term, 56 days and along the lines of IEC publications 60068-2); "Recommended basic climatic and mechanical robustness testing procedure for electronic components" and under standard atmosphere conditions according to IEC 60068-1 subclause 5.3, unless otherwise specified. In some instances deviations from IEC applications were necessary for our specified method.

PERFORMANCE				
IEC 60115-1 CLAUSE	IEC 60068-2 TEST METHOD	TEST	PROCEDURE	REQUIREMENTS
4.6.1.1		Insulation resistance	500 V _{DC} during 1 min; V-block method	R _{ins min.} 100 MΩ
4.7		Voltage proof on insulation	1000 V _{RMS} during 1 min; V-block method	ΔR/R _{max.} ± 0.5 % + 0.05 Ω
4.8		Temperature coefficient	Between - 25 °C and + 155 °C RMWL R < 10 Ω R ≥ 10 Ω RMFL	0 to 600 ppm/°C; - 80 to 140 ppm/°C ± 250 ppm/°C
4.13		Short time overload	Room temperature P = 10 x P _n ; 5 s, V _{max.} for: RMF03L ≤ 1500 V RMF05L ≤ 2000 V RMF07L ≤ 2500 V RMF10L ≤ 3000 V	ΔR/R _{max.} ± 2 % + 0.1 Ω
4.16	21(U)	Robustness of terminations:		No damage
4.16.2	21(Ua1)	Tensile all samples	Load 45 N; 10 s	
4.17	20(Ta)	Solderability (after aging)	16 h at 155 °C; leads immersed in flux 600 for 2 ± 0.5 s in a solder bath at 235 ± 5 °C	Good tinning (≥ 95 % covered) no visible damage
4.18	20(Tb)	Resistance to soldering heat	Thermal shock: 3 s, 350 °C	ΔR/R _{max.} ± 1 % + 0.05 Ω
4.19	14(Na)	Rapid change of temperature	30 min at - 25 °C and 30 min + 275 °C; 5 cycles	No visible damage ΔR/R _{max.} ± 1 % + 0.05 Ω
4.22	6(Fc)	Vibration	Frequency 10 a 55 Hz, displacement 0.75 mm or acceleration 10 g, three directions; total 6 h (3 x 2 h)	No visible damage ΔR/R _{max.} ± 1 % + 0.05 Ω
4.23	2(Ba)	Climatic sequence: Dry heat	16 h, 155 °C	ΔR/R _{max.} ± 1 % + 0.05 Ω
4.23.2	30(Db)	Damp heat (accelerated) 1st cycle	24 h; 25 °C to 55 °C; 90 to 100 % RH	
4.23.3	1(Aa)	Cold	2 h; - 25 °C	
4.23.4	30 (Db)	Damp heat (accelerated) remaining cycles	5 days; 25 °C to 55 °C; 90 to 100 % RH	
4.23.6				
4.24	3 (Ca)	Damp heat (steady state)	56 days; 40 °C; 90 to 95 % RH; loaded with 0.01 P _n	ΔR/R _{max.} ± 3 % + 0.1 Ω
4.25.1		Endurance (at 70 °C)	1000 h load with P _n ; 1.5 h ON and 0.5 h OFF	ΔR/R _{max.} ± 5 % + 0.1 Ω

ADDITIONAL TESTS IN ACCORDANCE WITH BPV53-8.753/044			
1 ⁽¹⁾	Interruption after dump	<p>Simplified test circuit (safety box required): $V_1 = 256 V_{AC}$ $C = 100 \mu F$ Load = 1640Ω</p> <p>Procedure: Switch on the circuit; after warming up time minimum 5 s; short circuit one of the diodes in the bridge rectifier</p>	The resistor must interrupt without any sign of flame or material ejected from its body
2 ⁽¹⁾	Test of overload current	<p>Simplified test circuit (safety box required): $V_1 = 256 V_{AC}$ $C = 500 \mu F$ Load = 1640Ω</p> <p>Procedure: Pulse ON/OFF the circuit for 10 times; interval between pulses: 10 s maximum</p>	$\Delta R/R_{max.} \pm 2\% + 0.1 \Omega$

Note:

⁽¹⁾ Value range for RMW05L and RMW07L; $1 \Omega < \text{value range} \leq 10 \Omega$

TYPICAL CIRCUIT APPLICATION

The typical application for these resistors is inrush current limitation of line connected at input stage of power supplier.

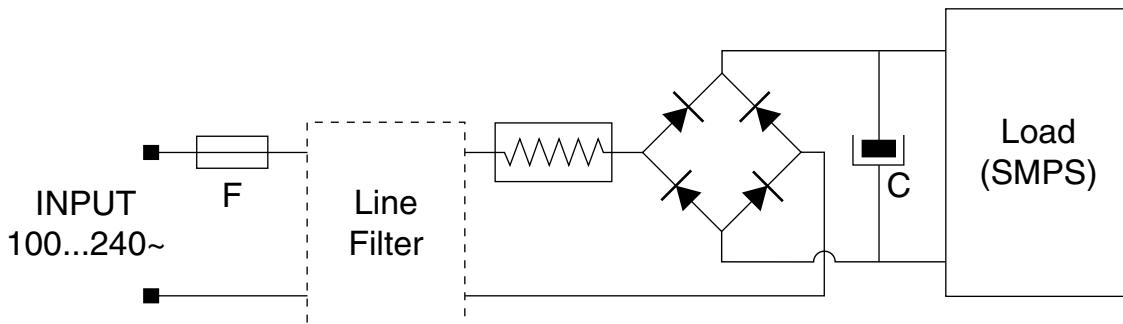



Disclaimer

All product specifications and data are subject to change without notice.

Vishay Intertechnology, Inc., its affiliates, agents, and employees, and all persons acting on its or their behalf (collectively, "Vishay"), disclaim any and all liability for any errors, inaccuracies or incompleteness contained herein or in any other disclosure relating to any product.

Vishay disclaims any and all liability arising out of the use or application of any product described herein or of any information provided herein to the maximum extent permitted by law. The product specifications do not expand or otherwise modify Vishay's terms and conditions of purchase, including but not limited to the warranty expressed therein, which apply to these products.

No license, express or implied, by estoppel or otherwise, to any intellectual property rights is granted by this document or by any conduct of Vishay.

The products shown herein are not designed for use in medical, life-saving, or life-sustaining applications unless otherwise expressly indicated. Customers using or selling Vishay products not expressly indicated for use in such applications do so entirely at their own risk and agree to fully indemnify Vishay for any damages arising or resulting from such use or sale. Please contact authorized Vishay personnel to obtain written terms and conditions regarding products designed for such applications.

Product names and markings noted herein may be trademarks of their respective owners.