SEI Electronics - Company Profile

- **A Little History . . .**

SEI Electronics started manufacturing resistors in 1928, as part of the Stackpole Carbon Company in St. Mary's Pennsylvania. To this day, SEI continues to focus on resistor products – and nothing else.

In 1986, the senior managers of Stackpole's resistor business bought the resistor operations from the Stackpole Corporation and established a separate company under the name Stackpole Electronics. Following a short transitional period, the name of the company was changed to SEI Electronics, Inc. to further establish a clearly independent identity.

In 1989, SEI strengthened its manufacturing base by becoming formally affiliated with Akahane Electronics in Japan, which has (resistor) manufacturing plants in Japan, Taiwan and mainland China. Today SEI is one of the largest exclusive resistor suppliers in the world, with headquarters in Raleigh, North Carolina and a large distribution facility and customer service center in El Paso, Texas. In addition, SEI is in the process of building a solid global presence with a new distribution center in Toronto (adding to our existing facility in Singapore).

SEI's products are used in virtually every segment of the electronics market – including computers and computer peripherals, telecommunications, automotive, consumer electronics, industrial controls, medical electronics, and measurement and testing equipment. The vast majority of these customers purchase products through SEI's network of national and regional electronics distributors. SEI also sells directly to a select group of original equipment manufacturers (OEM's) and to a growing base of contract electronics manufacturers (CEM's). Field sales activities are managed by SEI's sales staff and supported by an experienced group of sales representatives throughout North America.

- **Great Products, Great Quality**

SEI specializes in fixed resistors, and because of our specialization, we are able to supply an extensive range of surface mount and axial-leaded resistor products. We have significant market share in all of the "high demand" fixed resistor products, including Thick Film Chip, Thick Film Chip Arrays, Carbon Film, Metal Film, and Metal Oxide resistors. In addition, SEI is the only active supplier of Carbon Composition resistors remaining in North America.

We also take pride in our ability to support more specialized products, including our line of ultra-precision metal film resistors. Our focus on resistors allows us to offer inventory and short lead-time programs on these unique products when others cannot (or are unwilling to do so). And in case you're wondering, we are ISO 9002 certified and we're in the process of pursuing QS 9000 registration.

- **Superior Service**

We are proud of the fact that our distributors tell us that SEI is the best, most service-oriented supplier in the industry. We've earned this reputation by listening to our customers' needs, and then working very hard at every aspect of our business to address those needs. SEI realizes that success rarely happens by accident, and for that reason, there are a number of well-designed programs behind every "yes" we say to customers. One example is our extensive inventory (over 2 billion resistors in stock) of the products that we know the market demands, supported by the shortest manufacturing lead-times in the industry. We add to the effectiveness of our inventory by putting the systems and people in place to process and ship "same day" orders with ease. We realize that the market demands products "off the shelf", and we deliver, every day.

- **Leading Edge Technology for Our Customers**

And now SEI is changing the way engineers and buyers of resistors do business by providing the first truly functional WEB site in the industry. We were not satisfied with a web site that simply told a marketing story; we wanted one that provided real business tools. As a result, our customers can now do stock checks 24 hours a day, can access purchase order details right down to who signed for the shipment, and can review shipment schedules to guarantee that the products on order are exactly what production needs. Engineers can access product specifications fast, without having to click through a maze of pages of unimportant data. This is how the web should work! Check it out at www.seiselect.com.

When we look at the combination of everything we offer, we often refer to it as the ResistorPlus Program because we supply resistors plus all the service and support needed to effectively manage the supply chain. Give us a call today and see how we can make your life easier by servicing all of your resistor needs – no hassles, no problems. SEI Electronics, your primary source for quality resistor products.

www.DataSheet4U.com

SEI Electronics Inc. • P.O. Box 58789 • Raleigh, NC 27658-8789 • Telephone: (919) 850-9500 • FAX: (919) 850-9504
Toll Free: (888) SEI-SEI-SEI • www.seiselect.com • email: marketing@seiselect.com • ISO 9002 Registered

TABLE OF CONTENTS

A – Chip Resistors & Arrays

Thick Film Chip Resistors	RMC Series	A-1/4
High Value Chip Resistors	HMC Series	A-5
Thick Film Trimmable Chip Resistors	FCR Series	A-6
Thin Film Chip Resistors	RNC Series	A-7/8
Precision Thick Film Chip Resistors	RGC Series	A-9/10
Surface Mount Metal Element Resistors	SRL Series	A-11/12
Surface Mount Wirewound Resistors	SRW Series	A-13/14
Chip Resistor Array	RAC Series	A-15/16
Chip Resistor Array	RAV Series	A-17/18

B – SIP Networks

Thick Film Resistor Networks	LC & HC Series	B-1/2
Thick Film Resistor Networks	MC Series	B-3/4

C – Metal Resistors

Metal Film Resistors	RN Series	C-1
Metal Film Mini Series Resistors	RNM Series	C-2
Metal Film Resistors	MP Series	C-3
Low Value Metal Film Resistors	LV Series	C-4
Fusing Resistors	FRN Series	C-5
Metal Film Resistor Performance Curves		C-6
Metal Oxide Resistors	RS Series	C-7
Metal Oxide Mini Series Resistors	RSM Series	C-8
High Resistance Metal Oxide Mini Resistors	RLFS Series	C-9
Metal Oxide Resistor Performance Curves		C-10
Low Resistance Metal-Alloy Mini Resistors	RMF Series	C-11
High Resistance Metal (Glaze) Resistors	RMG Series	C-12
Pulse Metal (Glaze) Resistors	CRMG Series	C-13
Jumper Wire	JW Series	C-14
Zero-Ohm Resistors	CD Series	C-14

D – Carbon Resistors

Carbon Film Resistors	CF Series	D-1
Carbon Film Mini Series Resistors	CFM Series	D-2
Carbon Film Resistor Performance Curves		D-3/4
Carbon Composition Resistors	RC Series	D-5/6

E – Wirewound Resistors

Wirewound Resistors	WRF Series	E-1/2
Wirewound Ceramic Resistors	NSP1 Series	E-3
Vertical Mount Ceramic Wirewound Resistors	NSM Series	E-4

F – Packaging & Technical Information

Axial Lead		F-1
Radial Lead		F-2
Chip Resistors		F-3
Lead Forming Capabilities		F-4
General Product Information		F-5/6
Resistor Selection Guide		F-7/8

Thick Film Chip Resistors

SEI Type RMC

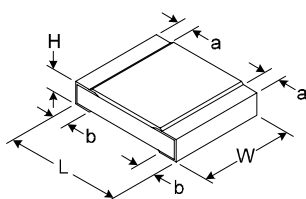

- Surface Mount Devices (SMD)
- Tolerances of $\pm 1\%$ and $\pm 5\%$
- Temperature Coefficients as Low as $\pm 100\text{ppm}/^\circ\text{C}$
- Precision Performance – Space Saving Construction
- Available from 0.02 ohm to 20 megohms

PERFORMANCE CHARACTERISTICS (TESTED PER MIL-STD-202)

ELECTRICAL (Operating Temperature Range: -55°C to $+125^\circ\text{C}$)

TYPE	Package Size	Power Rating (Watts)	Maximum Working Voltage	Maximum Overload Voltage	Resistance Temperature Coefficient	Resistance Range	Tolerance	Current Rating of Jumper ⁵
RMC 1/16S	0402	1/16 @ 70°C	50V	100V	$\pm 350\text{ppm}/^\circ\text{C}$ $\pm 200\text{ppm}/^\circ\text{C}$ $\pm 200\text{ppm}/^\circ\text{C}$	2.2 Ω – 9.1 Ω 10 Ω – 10M 10 Ω – 1M	$\pm 5\%$ $\pm 5\%$ $\pm 1\%$	1A max.
RMC 1/16	0603	1/16 ¹ @ 70°C	50V	100V	$\pm 350\text{ppm}/^\circ\text{C}$ $\pm 200\text{ppm}/^\circ\text{C}$ $\pm 350\text{ppm}/^\circ\text{C}$ $\pm 100\text{ppm}/^\circ\text{C}$	1.0 Ω – 9.1 Ω 10 Ω – 1M 1.1M – 20M 10 Ω – 3.24M	$\pm 5\%$ $\pm 5\%$ $\pm 5\%$ $\pm 1\%$	1A max.
RMC 1/10	0805	1/10 ² @ 70°C	150V	300V	$\pm 350\text{ppm}/^\circ\text{C}$ $\pm 200\text{ppm}/^\circ\text{C}$ $\pm 350\text{ppm}/^\circ\text{C}$ $\pm 350\text{ppm}/^\circ\text{C}$ $\pm 100\text{ppm}/^\circ\text{C}$ $\pm 350\text{ppm}/^\circ\text{C}$	0.02 Ω – 9.1 Ω 10 Ω – 1M 1.1M – 20M 1.0 Ω – 9.76 Ω 10 Ω – 1M 1.02M – 3.24M	$\pm 5\%$ $\pm 5\%$ $\pm 5\%$ $\pm 1\%$ $\pm 1\%$ $\pm 1\%$	2A max.
RMC 1/8	1206	1/8 ³ @ 70°C	200V	400V	$\pm 350\text{ppm}/^\circ\text{C}$ $\pm 200\text{ppm}/^\circ\text{C}$ $\pm 500\text{ppm}/^\circ\text{C}$ $\pm 350\text{ppm}/^\circ\text{C}$ $\pm 100\text{ppm}/^\circ\text{C}$ $\pm 350\text{ppm}/^\circ\text{C}$	0.02 Ω – 9.1 Ω 10 Ω – 1M 1.1M – 33M 1.0 Ω – 9.76 Ω 10 Ω – 1M 1.02M – 20M	$\pm 5\%$ $\pm 5\%$ $\pm 5\%$ $\pm 1\%$ $\pm 1\%$ $\pm 1\%$	2A max.
RMC 1/4	1210	1/4 ⁴ @ 70°C	200V	400V	$\pm 350\text{ppm}/^\circ\text{C}$ $\pm 200\text{ppm}/^\circ\text{C}$ $\pm 350\text{ppm}/^\circ\text{C}$ $\pm 100\text{ppm}/^\circ\text{C}$	1.0 Ω – 9.1 Ω 10 Ω – 1M 1.1M – 10M 10 Ω – 1M	$\pm 5\%$ $\pm 5\%$ $\pm 5\%$ $\pm 1\%$	3A max.
RMC 1/2	2010	1/2 @ 70°C	200V	400V	$\pm 350\text{ppm}/^\circ\text{C}$ $\pm 200\text{ppm}/^\circ\text{C}$ $\pm 100\text{ppm}/^\circ\text{C}$	0.02 Ω – 9.1 Ω 10 Ω – 1M 10 Ω – 1M	$\pm 5\%$ $\pm 5\%$ $\pm 1\%$	3A max.
RMC 1	2512	1 @ 70°C	200V	400V	$\pm 350\text{ppm}/^\circ\text{C}$ $\pm 200\text{ppm}/^\circ\text{C}$ $\pm 100\text{ppm}/^\circ\text{C}$	0.02 Ω – 9.1 Ω 10 Ω – 8.2M 10 Ω – 1M	$\pm 5\%$ $\pm 5\%$ $\pm 1\%$	3A max.

DIMENSIONS: Inches (mm)

FEATURE	RMC 1/16S	RMC 1/16	RMC 1/10	RMC 1/8
L – Body Length	.039 +.004/-.002 (1.00 +0.10/-0.05)	.063 \pm .004 (1.60 \pm 0.10)	.078 \pm .008 (2.00 \pm 0.20)	.122 \pm .004 (3.10 \pm 0.10)
W – Body Width	.020 +.004/-.002 (0.50 +0.10/-0.05)	.031 +.006/-.002 (0.80 +0.15/-0.05)	.049 \pm .008 (1.25 \pm 0.20)	.061 \pm .004 (1.55 \pm 0.10)
H – Body Height	.014 \pm .002 (0.35 \pm 0.05)	.018 \pm .004 (0.45 \pm 0.10)	.018 \pm .004 (0.45 \pm 0.10)	.021 +.004/-.002 (0.55 +0.10/-0.05)
a – Top Termination	.008 \pm .004 (0.20 \pm 0.10)	.010 \pm .004 (0.25 \pm 0.10)	.016 \pm .008 (0.40 \pm 0.20)	.018 \pm .008 (0.45 \pm 0.20)
b – Bottom Termination	.010 +.008/-.004 (0.25 +0.20/-0.10)	.012 +.008/-.004 (0.30 +0.20/-0.10)	.012 +.008/-.004 (0.30 +0.20/-0.10)	.012 +.008/-.004 (0.30 +0.20/-0.10)
FEATURE	RMC 1/4	RMC 1/2	RMC 1	
L – Body Length	.122 \pm .004 (3.10 \pm 0.10)	.197 \pm .008 (5.00 \pm 0.20)	.248 \pm .008 (6.30 \pm 0.20)	
W – Body Width	.100 \pm .004 (2.55 \pm 0.10)	.098 \pm .008 (2.50 \pm 0.20)	.124 \pm .008 (3.15 \pm 0.20)	
H – Body Height	.021 +.004/-.002 (0.55 +0.10/-0.05)	.021 \pm .004 (0.55 \pm 0.10)	.021 \pm .004 (0.55 \pm 0.10)	
a – Top Termination	.018 \pm .008 (0.45 \pm 0.20)	.020 \pm .008 (0.50 \pm 0.20)	.020 \pm .008 (0.50 \pm 0.20)	
b – Bottom Termination	.012 +.008/-.004 (0.30 +0.20/-0.10)	.020 \pm .008 (0.50 \pm 0.20)	.020 \pm .008 (0.50 \pm 0.20)	

www.DataSheet4U.com

SEI Electronics Inc. • P.O. Box 58789 • Raleigh, NC 27658-8789 • Telephone: (919) 850-9500 • FAX: (919) 850-9504
Toll Free: (888) SEI-SEI-SEI • www.seielect.com • email: marketing@seielect.com • ISO 9002 Registered

Thick Film Chip Resistors

SEI Type RMC

PERFORMANCE CHARACTERISTICS

ENVIRONMENTAL	Specification Requirement	Tested per EIA J-RC-2690A	Typical
Moisture Resistance, Thermal Shock	$\pm(1\% +0.05\Omega)$, No Mechanical Damage	-55°C to +125°C, 5 cycles	Within $\pm 0.2\%$
Low Temperature Exposure	$\pm(3\% +0.1\Omega)$, No Mechanical Damage	-55°C, 1,000 hours	Within $\pm 0.5\%$
Load Life	$<1\text{ meg } \pm(3\% +0.1\Omega)$, $\geq 1\text{ meg } \pm 5\%$	70°C, rated voltage, 1.5hr on/0.5hr off, 1000 hrs	See graph
Load Life in Moisture	$<1\text{ meg } \pm(3\% +0.1\Omega)$, $\geq 1\text{ meg } \pm 5\%$	40°C, 95% R.H., 1.5hr on/0.5hr off, 1,000 hrs	See graph
Vibration	$\pm(1\% +0.05\Omega)$, No Mechanical Damage	10-55 Hz, 3 direction, each 2 hours	Within $\pm 0.1\%$
Resistance to Soldering Heat	$\pm(1\% +0.05\Omega)$, No Mechanical Damage	270°C, 10 seconds	See graph
Solderability	min. 95% coverage	230°C, 3 seconds, flux applied ¹	More than 97%
Heat Resistance	Adhesion Curing Dry Heat	$\pm(1\% +0.05\Omega)$ -125°C , 1,000 hours	Within $\pm 0.3\%$ Within $\pm 0.5\%$
Terminal Strength	Pull Board Bending	500G load, 30 seconds 1/45mm bend, 10 seconds	Within $\pm 0.2\%$ Within $\pm 0.2\%$
Dielectric Withstanding Voltage	No insulation breakdown	500V, 1 minute	Above 900V
Short Time Overload	$\pm(1\% +0.05\Omega)$, No evidence of arc	2 ¹ / ₂ times rated voltage, 5 seconds	Within $\pm 0.4\%$
Insulation Resistance	1,000 meg minimum	500V, 1 minute	Above 10 ⁶ meg
Voltage Coefficient	+0/-100ppm/V (above 1K \pm)	Rated voltage & 1/10 times rated voltage	Within -90ppm/V

Note 1. Maximum solder flow process "Normal" 275°C, 30 seconds or the "SM10" process @ 310°C for 10 seconds.

MATERIALS

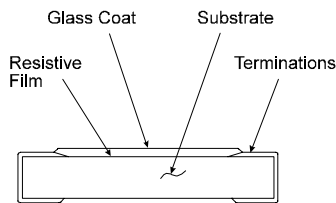

Feature	Material	Remarks (Reference Only)
Substrate	Alumina Porcelain	Purity 96% min.
Resistive Film	Ruthenium-Oxide Film	20 Microns Thick
Coating	Boro-Silicated Acid Lead Glass	20 Microns Thick
Terminations	90/10 Tin-Lead (Electrical Plated) over Nickel (Electrical Plated) over AG-PD (Silver-Palladium[Glaze Printed])	3 Microns Thick 3 Microns Thick 8 Microns Thick

MARKING

Marking



Resistance value in three-digit designation system is marked on the glasscoat. Illustrated is a resistor of 15K Ω . Four-digit resistance designation system is applied to RMC 1/8 and E-96 Series. For example, 1502 designated 15K Ω . (The last digit specifies the number of zeros.)

5% 3-digit	1% 4-digit
0603*	0805
0805	1206
1206	1210
1210	2010
2010	2512
2512	

* For 1%, a 3-digit alpha-numeric marking system is used. Contact factory for details.

ORDERING INFORMATION

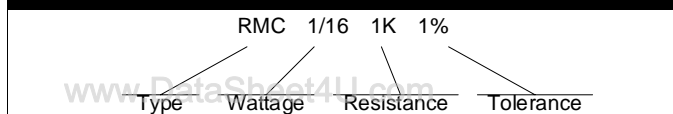

NOTES

1. RMC 1/16 is Dual Rated at 1/10W.
2. RMC 1/10 is Dual Rated at 1/8W.
3. RMC 1/8 is Dual Rated at 1/4W.
4. RMC 1/4 is Dual Rated at 3/4W.
5. Zero ohm (0.05 Ω max.) jumper available in all sizes.

Thick Film Chip Resistors

SEI Type RMC

PERFORMANCE CURVES

Power - Temperature Derating

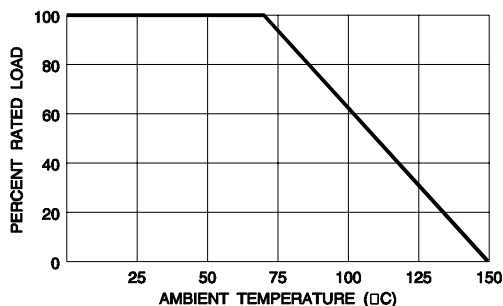

Current Noise

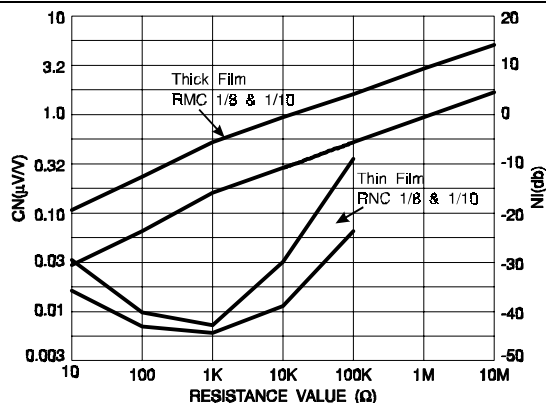

NOTE: RNC is Thin Film (see page A-7)

Load Life in Moisture (1,000 hrs)

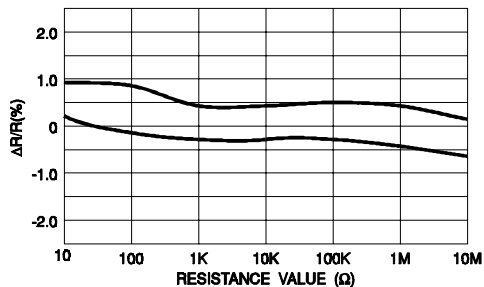

Load Life (1,000 hrs)

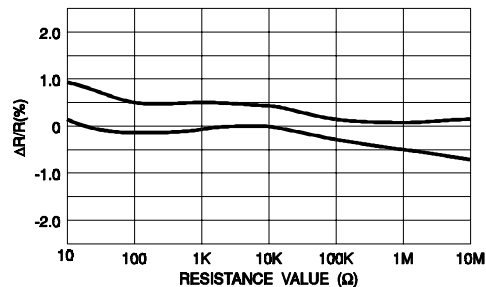

High Frequency Characteristics

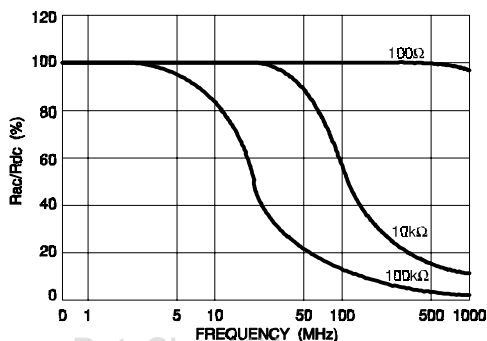

Resistance to Soldering Heat

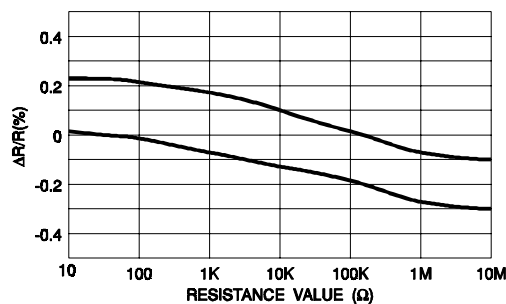

www.DataSheet4U.com

Thick Film Chip Resistors

SEI Type RMC

PERFORMANCE CURVES

Surface Temperature Rise vs. Load – RMC-1/10



Surface Temperature Rise vs. Load – RMC-1/8

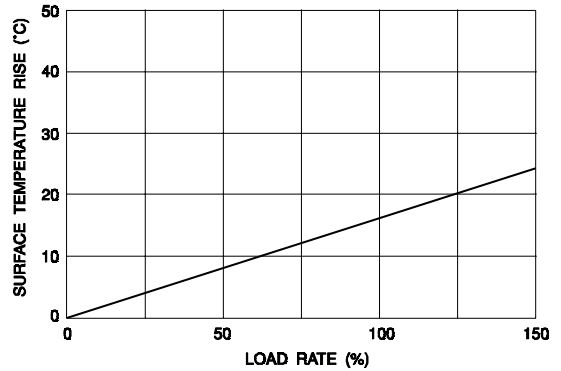

Surface Temperature Rise vs. Load – RMC-1/4

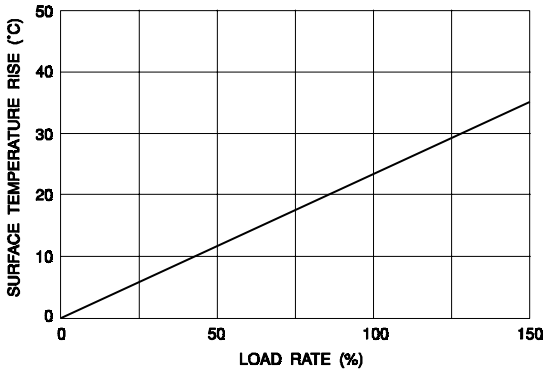

Surface Temperature Rise vs. Load – RMC-1/2

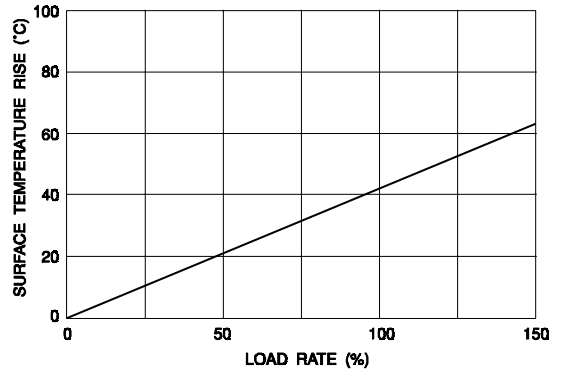

Surface Temperature Rise vs. Load – RMC-1

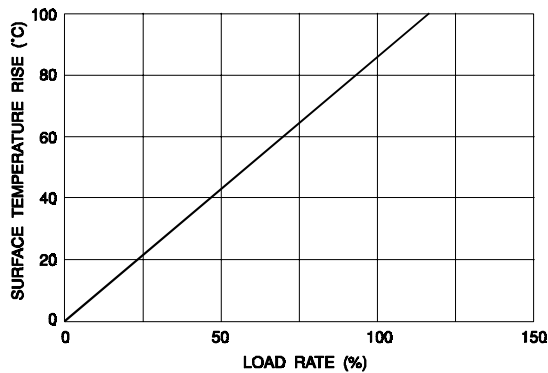

High Value Chip Resistors

SEI Type HMC

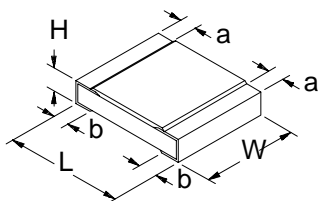

- R Value extension of RMC product
- Small in size, lightweight, and ideal for application in labor-saving equipment
- A wide range of operating temperatures
- Stable performance obtained because of minimized changes with age

PERFORMANCE CHARACTERISTICS

ELECTRICAL						
Type	Package Size	Power Rating (Watts)	Maximum Working Voltage (DC)	Maximum Overload Voltage (DC)	Resistance Range (Ω) ¹	Resistance Tolerance
HMC 1/16	0805	1/16	75V	150V	$10^6 - 10^{11}$	$\pm 5\%$
HMC 1/8	1206	1/8	150V	300V	$10^6 - 10^{11}$	$\pm 5\%$
ENVIRONMENTAL		Characteristics		Test Method		
Long-term stability		$\pm 0.5\%$		Normal temperature & humidity for 1,000 hours		
High Temperature Loading		$\pm 1\%$		15V DC, 1.5hr ON, 0.5hr OFF, 1,000hr 70°C		
Resistance to Soldering Heat		$\pm 1\%$		260°C $\pm 5^\circ\text{C}$, 10 seconds +1/-0		
Short Time Overload		$\pm 2\%$		5 seconds at maximum overload voltage		

Temperature Coefficient (TCR) 25°C–125°C

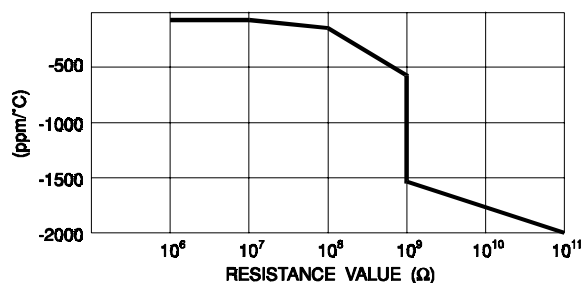

Voltage Coefficient (VCR) 5V–15V

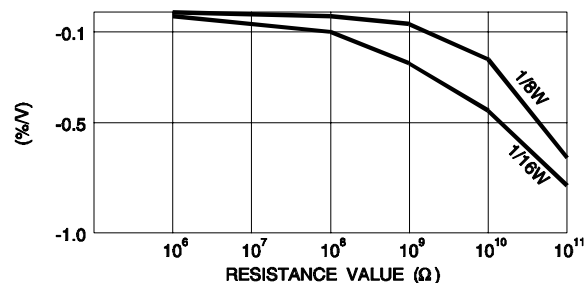

DIMENSIONS: Inches (mm)

FEATURE	HMC 1/16	HMC 1/8
L – Body Length	.079 \pm .008 (2.0 \pm 0.2)	.125 \pm .008 (3.2 \pm 0.2)
W – Body Width	.049 \pm .008 (1.25 \pm 0.2)	.063 \pm .008 (1.6 \pm 0.2)
H – Body Height	.016 \pm .004 (0.4 \pm 0.1)	.020 \pm .004 (0.5 \pm 0.1)
a – Top Termination	.016 \pm .008 (0.4 \pm 0.2)	.020 \pm .012 (0.5 \pm 0.3)
b – Bottom Termination	.016 \pm .008 (0.4 \pm 0.2)	.020 \pm .012 (0.5 \pm 0.3)

ORDERING INFORMATION

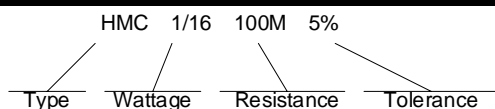

NOTES

1. Contact factory for additional resistance tolerances.

Thick Film Trimmable Chip Resistors

SEI Type FCR

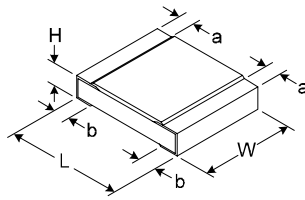

- Surface Mount Device (SMD)
- Laser Trimmable in Circuit
- Tolerances of $\pm 15\%$ and $+0/-30\%$
- Temperature Coefficients of $\pm 200\text{ppm}/^\circ\text{C}$
- Precision Performance – Space Saving Construction
- Available from 10 ohm to 1 megohm

PERFORMANCE CHARACTERISTICS (TESTED PER MIL-STD-202)

ELECTRICAL (Operating Temperature Range: -55°C to $+155^\circ\text{C}$)

TYPE	Package Size	Power Rating (Watts)	Maximum Working Voltage	Maximum Overload Voltage	Resistance Temperature Coefficient	Resistance Range ¹	Tolerance
FCR 1/10	0805	1/10 @ 70°C	150V	300V	$\pm 200\text{ppm}/^\circ\text{C}$	10 Ω – 1M	$\pm 15\%$ or $+0/-30\%$
FCR 1/8	1206	1/8 @ 70°C	200V	400V	$\pm 200\text{ppm}/^\circ\text{C}$	10 Ω – 1M	$\pm 15\%$ or $+0/-30\%$
FCR 1/4	1210	1/4 @ 70°C	200V	400V	$\pm 200\text{ppm}/^\circ\text{C}$	10 Ω – 1M	$\pm 15\%$ or $+0/-30\%$

TRIMMING RATIO

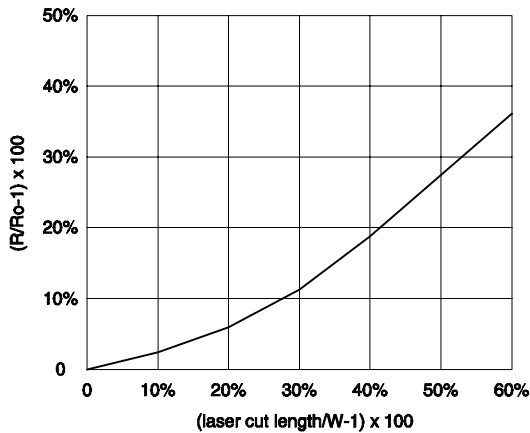

MATERIALS

Feature	Material	Remarks (Reference Only)
Substrate	Alumina Porcelain	Purity 96% min.
Resistive Film	Ruthenium-Oxide Film	20 Microns Thick
Coating	Boro-Silicated Acid Lead Glass	20 Microns Thick
Terminations	90/10 Tin-Lead (Electrical Plated) over Nickel (Electrical Plated) over AG-PD (Silver-Palladium [Glaze Printed])	3 Microns Thick 3 Microns Thick 8 Microns Thick

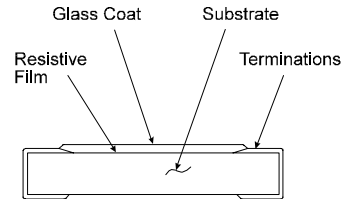

DIMENSIONS: Inches (mm)

FEATURE	FCR 1/10	FCR 1/8	FCR 1/4
L – Body Length	.078 \pm .008 (2.00 \pm 0.20)	.122 \pm .004 (3.10 \pm 0.10)	.122 \pm .004 (3.10 \pm 0.10)
W – Body Width	.049 \pm .008 (1.25 \pm 0.20)	.061 \pm .004 (1.55 \pm 0.10)	.100 \pm .004 (2.55 \pm 0.10)
H – Body Height	.018 \pm .004 (0.45 \pm 0.10)	.021 \pm .004/-0.002 (0.55 \pm 0.10/-0.05)	.021 \pm .004/-0.002 (0.55 \pm 0.10/-0.05)
a – Top Termination	.016 \pm .008 (0.40 \pm 0.20)	.018 \pm .008 (0.45 \pm 0.20)	.018 \pm .008 (0.45 \pm 0.20)
b – Bottom Termination	.012 \pm .008/-0.004 (0.30 \pm 0.20/-0.10)	.012 \pm .008/-0.004 (0.30 \pm 0.20/-0.10)	.012 \pm .008/-0.004 (0.30 \pm 0.20/-0.10)

ORDERING INFORMATION

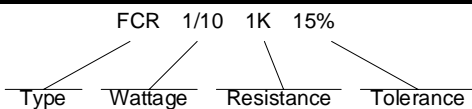

NOTES

1. E-24 resistance ranges apply.

Thin Film Chip Resistors

SEI Type RNC

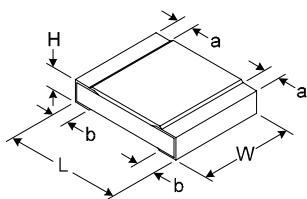

- Surface Mount Devices (SMD)
- Precision Tolerances of $\pm 0.5\%$ to $\pm 0.1\%$
- Temperature Coefficients of $\pm 50\text{ppm}/^\circ\text{C}$ and $\pm 25\text{ppm}/^\circ\text{C}$
- Precision Performance
- E96 Resistance Values

PERFORMANCE CHARACTERISTICS (TESTED PER MIL-STD-202)

ELECTRICAL (Operating Temperature Range: -55°C to $+155^\circ\text{C}$)

TYPE	Package Size	Power Rating (Watts)	Maximum Working Voltage	Maximum Overload Voltage	Resistance Temperature Coefficient	Resistance Range ³	Tolerance ¹
RNC 16 (T2) (T9)	0603	1/16 @ 70°C	50V	100V	$\pm 50\text{ppm}/^\circ\text{C}$ $\pm 25\text{ppm}/^\circ\text{C}$	10 Ω – 33K 100 Ω – 33K	$\pm 0.5\%$, $\pm 0.1\%$
RNC 20 (T2) (T9)	0805	1/10 @ 70°C	75V	150V	$\pm 50\text{ppm}/^\circ\text{C}$ $\pm 25\text{ppm}/^\circ\text{C}$	10 Ω – 100K 10 Ω – 100K	$\pm 0.5\%$, $\pm 0.25\%$, $\pm 0.1\%$
RNC 32 (T2) (T9)	1206	1/8 @ 70°C	150V	300V	$\pm 50\text{ppm}/^\circ\text{C}$ $\pm 25\text{ppm}/^\circ\text{C}$	10 Ω – 100K 10 Ω – 100K	$\pm 0.5\%$, $\pm 0.25\%$, $\pm 0.1\%$

ENVIRONMENTAL	Specification	Typical	Test Method
Moisture Resistance, Thermal Shock	$\pm(0.25\% + 0.05\Omega)$	$\leq 0.1\%$	JIS C 5202 7.4
Load Life	$\pm(0.5\% + 0.05\Omega)$	$\leq 0.2\%$	JIS C 5202 7.10
Load Life in Moisture	$\pm(0.5\% + 0.05\Omega)$	$\leq 0.25\%$	JIS C 5202 7.9
Resistance to Soldering Heat	$\pm(0.25\% + 0.05\Omega)$	$\leq 0.05\%$	JIS C 5202 6.4, $260\pm 5^\circ\text{C}$, 10 seconds
Solderability	min. 95% coverage	$\geq 95\%$	JIS C 5202 6.5
Terminal Strength	$\pm(0.2\% + 0.05\Omega)$	$\leq 0.05\%$	EIAJ RC-2609A 6.6
Dielectric Withstanding Voltage	$\pm(0.25\% + 0.05\Omega)$	$\leq 0.05\%$	EIAJ RC-2690A 6.5 Test Voltage: RNC 20 @ 150VAC, RNC 32 @ 300VAC
Short Time Overload	$\pm(0.25\% + 0.05\Omega)$	$\leq 0.05\%$	JIS C 5202 5.5
Insulation Resistance	1,000 meg minimum	$\geq 1,000$ meg	EIAJ RC-2690A 6.4

MATERIALS

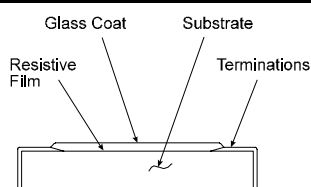

Feature	Material	Remarks (Reference Only)
Substrate	Alumina Porcelain	Purity 96% min.
Resistive Film	Nickel-Chromium Film	20 Microns Thick
Coating	Boro-Silicated Acid Lead Glass	20 Microns Thick
Terminations	90/10 Tin-Lead (Electrical Plated) over Nickel (Electrical Plated) over AG-PD (Silver-Palladium [Glaze Printed])	3 Microns Thick 3 Microns Thick 8 Microns Thick

DIMENSIONS: Inches (mm)

FEATURE	RNC 16	RNC 20	RNC 32
L – Body Length	.063 \pm .004 (1.60 \pm 0.10)	.078 \pm .008 (2.00 \pm 0.20)	.122 \pm .004 (3.10 \pm 0.10)
W – Body Width	.031 +.006/- .002 (0.80 +0.15/-0.05)	.049 \pm .008 (1.25 \pm 0.20)	.061 \pm .004 (1.55 \pm 0.10)
H – Body Height	.018 \pm .004 (0.45 \pm 0.10)	.018 \pm .004 (0.45 \pm 0.10)	.021 +.004/- .002 (0.55 +0.10/-0.05)
a – Top Termination	.010 \pm .004 (0.25 \pm 0.10)	.016 \pm .008 (0.40 \pm 0.20)	.018 \pm .008 (0.45 \pm 0.20)
b – Bottom Termination	.012 +.008/- .004 (0.30 +0.20/-0.10)	.012 +.008/- .004 (0.30 +0.20/-0.10)	.012 +.008/- .004 (0.30 +0.20/-0.10)

ORDERING INFORMATION

RNC 20 T2 1K 0.5%				
Type	Wattage	T.C.	Resistance	Tolerance

NOTES

1. 100 Ω minimum for $\pm 0.1\%$ tolerance.
2. Embossed taping available on RNC 32 only.
3. E96 Values only.

Thin Film Chip Resistors

SEI Type RNC

PERFORMANCE CURVES

Power - Temperature Derating

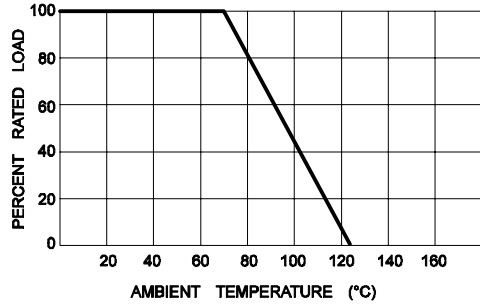

Resistance Temp. Coefficient (25°C/125°C)

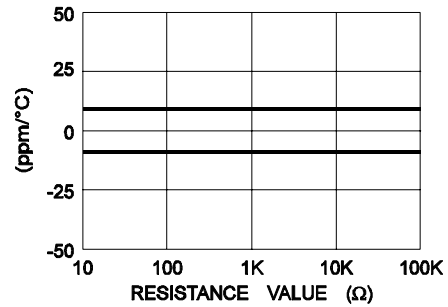

Load Life in Moisture (1,000 hrs)

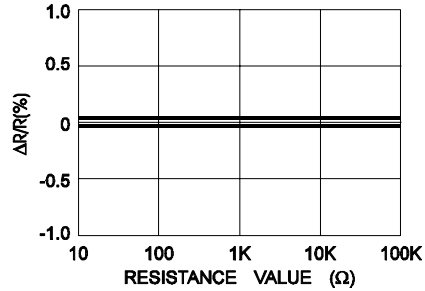

Short-Time Overload

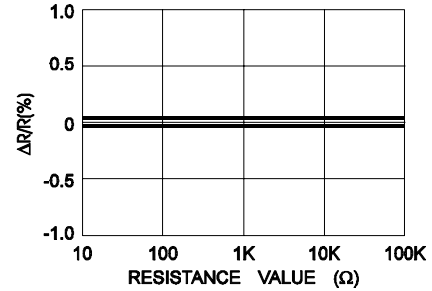

Temperature Cycle (-55°C/125°C, 5 cycles)

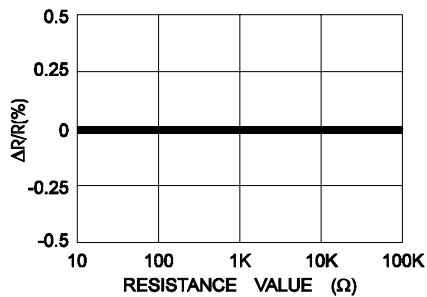

Resistance to Soldering Heat (260°C, 10 sec.)

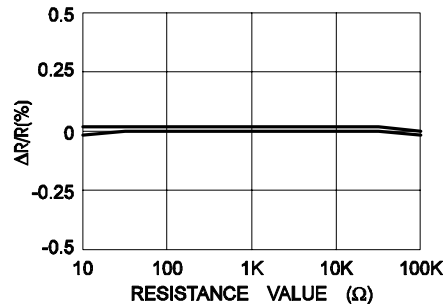

www.DataSheet4U.com

Precision Thick Film Chip Resistors

SEI Type RGC

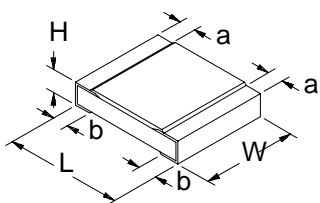

- Surface Mount Devices (SMD)
- Precision Tolerances of $\pm 1\%$ to $\pm 0.5\%$
- Temperature Coefficients of $\pm 100\text{ppm}/^\circ\text{C}$ and $\pm 50\text{ppm}/^\circ\text{C}$
- Precision Performance
- Less Sensitive to Electro-Static Discharge (ESD)
Than Comparable Thin Film Devices

PERFORMANCE CHARACTERISTICS (TESTED PER MIL-STD-202)

ELECTRICAL (Operating Temperature Range: -55°C to $+155^\circ\text{C}$)

TYPE	Package Size	Power Rating (Watts)	Maximum Working Voltage	Maximum Overload Voltage	Resistance Temperature Coefficient	Resistance Range ³	Tolerance
RGC 1/16S ¹ (T1)	0402	1/16 @ 70°C	50V	100V	$\pm 100\text{ppm}/^\circ\text{C}$	47.5 Ω – 3.24M	$\pm 1\%$
RGC 1/16 (T1) (T2)	0603	1/16 @ 70°C	50V	100V	$\pm 100\text{ppm}/^\circ\text{C}$ $\pm 50\text{ppm}/^\circ\text{C}$	47.5 Ω – 3.24M 100 Ω – 1M	$\pm 1\%$ $\pm 1\%, \pm 0.5\%$
RGC 1/10 (T1) (T2)	0805	1/10 @ 70°C	150V	300V	$\pm 100\text{ppm}/^\circ\text{C}$ $\pm 50\text{ppm}/^\circ\text{C}$	47.5 Ω – 3.24M 100 Ω – 1M	$\pm 1\%$ $\pm 1\%, \pm 0.5\%$
RGC 1/8 (T1) (T2)	1206	1/8 @ 70°C	200V	400V	$\pm 100\text{ppm}/^\circ\text{C}$ $\pm 50\text{ppm}/^\circ\text{C}$	47.5 Ω – 4.64M 100 Ω – 1M	$\pm 1\%$ $\pm 1\%, \pm 0.5\%$

MATERIALS

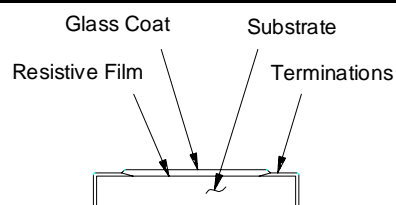

Feature	Material	Remarks (Reference Only)
Substrate	Alumina Porcelain	Purity 96% min.
Resistive Film	Ruthenium Dioxide Film	25 Microns Thick
Coating	Boro-Silicated Acid Lead Glass	20 Microns Thick
Terminations	90/10 Tin-Lead (Electrical Plated) over Nickel (Electrical Plated) over AG-PD (Silver-Palladium [Glaze Printed])	3 Microns Thick 3 Microns Thick 8 Microns Thick

DIMENSIONS: Inches (mm)

FEATURE	RGC 1/16S	RGC 1/16	RGC 1/10	RGC 1/8
L – Body Length	.040 \pm .002 (1.00 \pm 0.05)	.068 \pm .004 (1.60 \pm 0.10)	.078 \pm .008 (2.00 \pm 0.20)	.122 \pm .008 (3.10 \pm 0.20)
W – Body Width	.020 \pm .002 (0.50 \pm 0.05)	.031 +.006/-.002 (0.80 + 0.15/-0.05)	.049 +.004/-.002 (1.25 + 0.10/-0.05)	.061 \pm .004 (1.55 \pm 0.10)
H – Body Height	.014 \pm .002 (0.35 \pm 0.05)	.018 \pm .004 (0.45 \pm 0.10)	.021 \pm .004 (0.60 \pm 0.10)	.021 \pm .004 (0.60 \pm 0.10)
a – Top Termination	.008 \pm .004 (0.20 \pm 0.10)	.010 \pm .004 (0.25 \pm 0.10)	.016 \pm .008 (0.40 \pm 0.20)	.018 \pm .008 (0.45 \pm 0.20)
b – Bottom Termination	.010 \pm .002 (0.25 \pm 0.05)	.008 +.006/-.004 (0.20 + 0.15/-0.10)	.012 +.008/-.004 (0.30 + 0.20/-0.10)	.012 +.008/-.004 (0.30 + 0.20/-0.10)

ORDERING INFORMATION

RGC 1/10 T2 1K 0.5%				
Type	Wattage	T.C.	Resistance	Tolerance

NOTES

1. RGC 1/16S is dual rated – 0402 size but with 0603 power.
2. Embossed taping available on RGC 1/8 only.
3. E96 Values only.

Precision Thick Film Chip Resistors

SEI Type RGC

PERFORMANCE CURVES

Resistance Temperature Coefficient

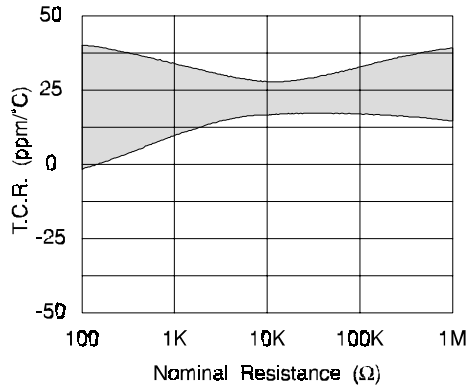

Short Time Overload

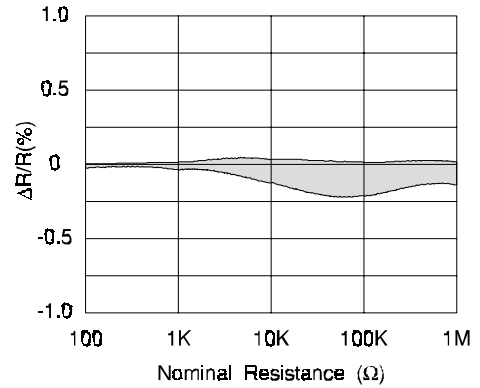

Solder Heat Resistance (260°C, 10 sec)

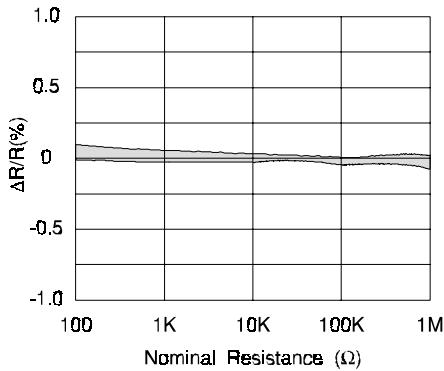

Temperature Cycle (-55°C/125°C, 5 cycles)

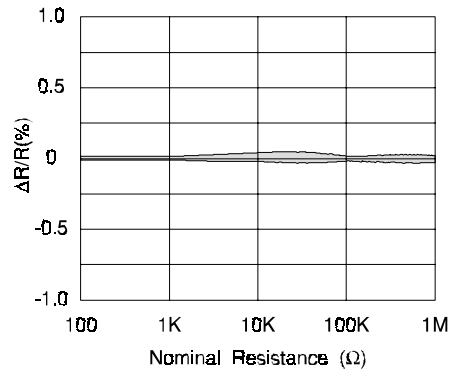

Load Life (Rated Load) (70°C, RCWV 1,000 hrs)

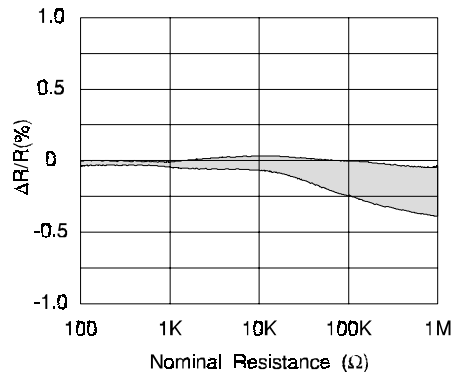

www.DataSheet4U.com

Surface Mount Metal Element Resistors

SEI Type SRL

- Very Low Values
- All Welded Construction
- Low Inductance
- Temperature Coefficient of $\pm 100\text{ppm}/^\circ\text{C}$

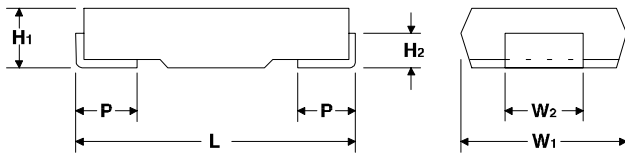

PERFORMANCE CHARACTERISTICS

ELECTRICAL	SRL 1S	SRL 2	SRL 3
Power Rating (Watts)	1 @ 70°C	2 @ 70°C	3 @ 70°C
Derated to 0 Load at	180°C	180°C	180°C
Maximum Working Voltage	\sqrt{PR}	\sqrt{PR}	\sqrt{PR}
Operating Temperature Range	-55°C to +180°C	-55°C to +180°C	-55°C to +180°C
Resistance Range	0.003 – 0.51Ω	0.005 – 1.0Ω	0.008 – 1.8Ω
Tolerance	±1% & ±5%	±1% & ±5%	±1% & ±5%
Dielectric Withstand Voltage	500 volts RMS	500 volts RMS	500 volts RMS
Insulation Resistance	100 meg min.	100 meg min.	100 meg min.
ENVIRONMENTAL (Operating Temperature Range: -55°C to +180°C)			
Moisture Resistance	±2%	±2%	±2%
Load Life @ 70°C – 1,000 hrs	±2%	±2%	±2%

DERATING CURVE

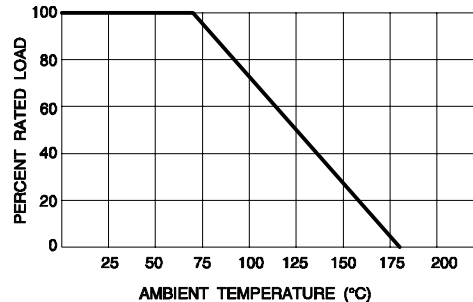

DIMENSIONS:

FEATURE	Inches (mm)		
	SRL 1S	SRL 2	SRL 3
L – Body Length	.30 ±.02 (7.5 ±0.5)	.49 ±.02 (12.5 ±0.5)	.57 ±.02 (14.5 ±0.5)
W ₁ – Body Width	.18 ±.01 (4.5 ±0.3)	.24 ±.01 (6.0 ±0.3)	.32 ±.01 (8.0 ±0.3)
W ₂ – Terminal Width	.10 ±.01 (2.5 ±0.3)	.16 ±.01 (4.0 ±0.3)	.24 ±.01 (6.0 ±0.3)
H ₁ – Body Height	.08 ±.01 (2.0 ±0.3)	.12 ±.01 (3.0 ±0.3)	.12 ±.01 (3.0 ±0.3)
H ₂ – Side Termination	.04 ±.01 (1.1 ±0.3)	.06 ±.01 (1.5 ±0.3)	.06 ±.01 (1.5 ±0.3)
P – Bottom Termination	.05 ±.01 (1.2 ±0.3)	.08 ±.01 (2.0 ±0.3)	.08 ±.01 (2.0 ±0.3)

ORDERING INFORMATION

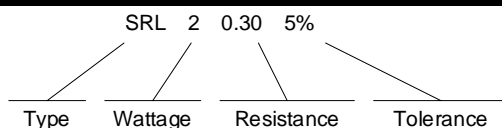

NOTES

1. Excellent current sensing application product.

www.DataSheet4U.com

Surface Mount Metal Element Resistors

SEI Type SRL

PERFORMANCE DATA

Temperature Rise Curves

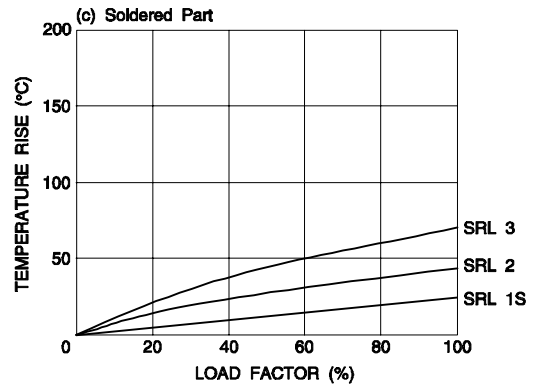
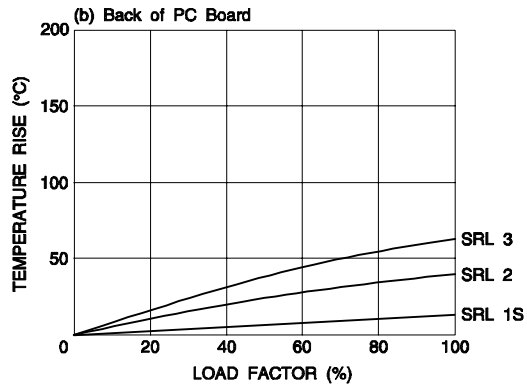
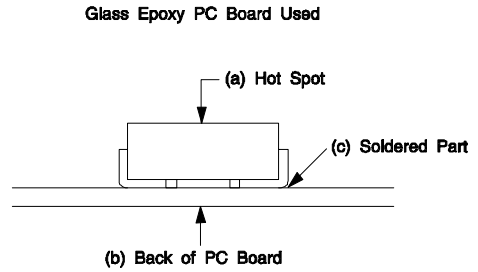
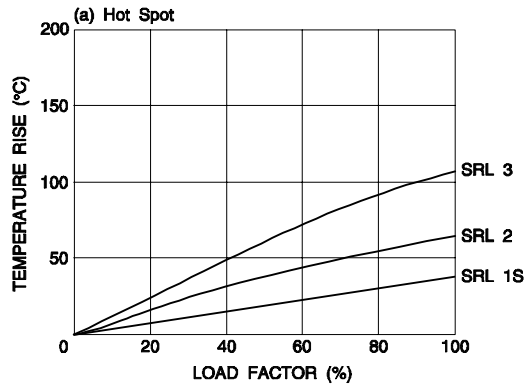

PACKAGING – Inches (mm)

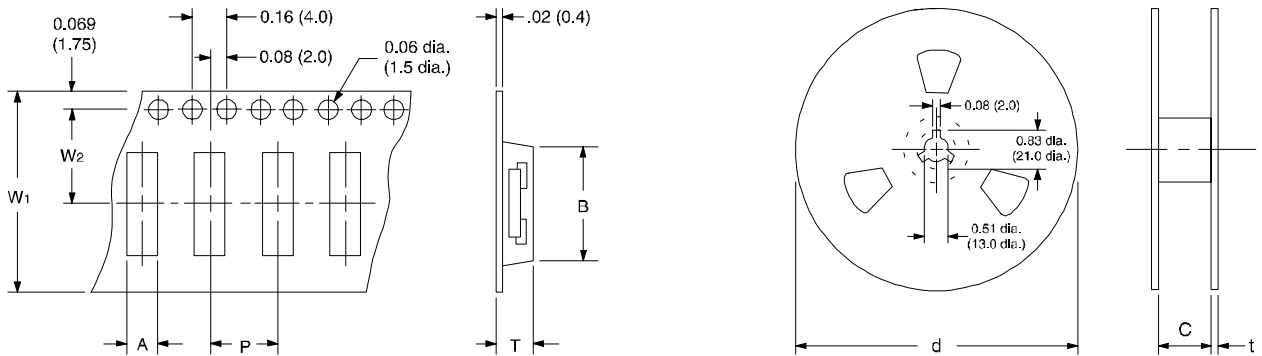

Packaging: 1,000 pc reel quantities

Style	A	B	W1	W2	P	T	d	C	t
SRL 1S	0.20 (5.1)	0.32 (8.2)	0.63 (16.0)	0.30 (7.5)	0.31 (8.0)	0.10 (2.5)	7.0 (178)	0.69 (17.5)	0.06 (1.6)
SRL 2	0.26 (6.6)	0.52 (13.2)	0.94 (24.0)	0.45 (11.5)	0.31 (8.0)	0.14 (3.5)	13.0 (330)	1.00 (25.5)	0.06 (1.6)
SRL 3	0.34 (8.6)	0.60 (15.2)	0.94 (24.0)	0.45 (11.5)	0.47 (12.0)	0.14 (3.5)	13.0 (330)	1.00 (25.5)	0.06 (1.6)

Surface Mount Wirewound Resistors

SEI Type SRW

- Molded Encapsulation
- Temperature Coefficient of $\pm 100\text{ppm}/^\circ\text{C}$
- Complements SRL Series for Resistance Values Above 0.51Ω

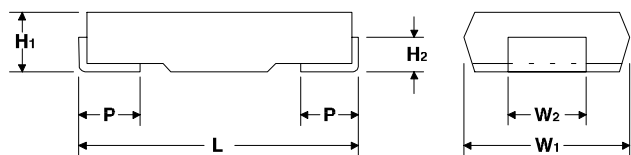

PERFORMANCE CHARACTERISTICS

ELECTRICAL	SRW 1	SRW 2
Power Rating (Watts)	1 @ 70°C	2 @ 70°C
Derated to 0 Load at	180°C	180°C
Maximum Working Voltage	$\sqrt{\text{PR}}$	$\sqrt{\text{PR}}$
Operating Temperature Range	-55°C to +180°C	-55°C to +180°C
Resistance Range	0.51 – 100Ω	1 – 100Ω
Tolerance	$\pm 1\%$ & $\pm 5\%$	$\pm 1\%$ & $\pm 5\%$
Dielectric Withstand Voltage	500 volts RMS	500 volts RMS
Insulation Resistance	100 meg min.	100 meg min.
ENVIRONMENTAL (Operating Temperature Range: -55°C to +180°C)		
Moisture Resistance	$\pm 2\%$	$\pm 2\%$
Load Life @ 70°C – 1,000 hrs	$\pm 2\%$	$\pm 2\%$
Resistance to Soldering Heat	$\pm 0.5\%$	$\pm 0.5\%$
Short Time Overload	$\pm 0.5\%$	$\pm 0.5\%$

DERATING CURVE

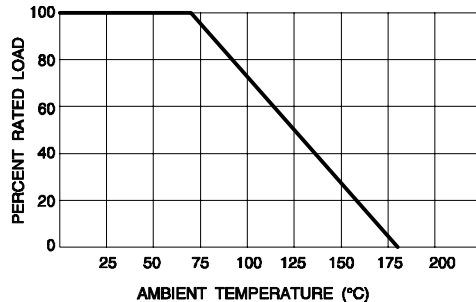

DIMENSIONS: Inches (mm)

FEATURE	SRW 1	SRW 2
L – Body Length	.30 ±.02 (7.5 ±0.5)	.49 ±.02 (12.5 ±0.5)
W ₁ – Body Width	.18 ±.01 (4.5 ±0.3)	.24 ±.01 (6.0 ±0.3)
W ₂ – Terminal Width	.10 ±.01 (2.5 ±0.3)	.16 ±.01 (4.0 ±0.3)
H ₁ – Body Height	.14 ±.01 (3.5 ±0.3)	.16 ±.01 (4.0 ±0.3)
H ₂ – Side Termination	.09 ±.01 (2.2 ±0.3)	.09 ±.01 (2.4 ±0.3)
P – Bottom Termination	.05 ±.01 (1.2 ±0.3)	.08 ±.01 (2.0 ±0.3)

ORDERING INFORMATION

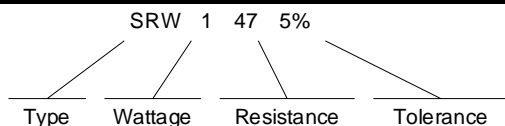

NOTES

1. See SRL Series for lower R-values.

www.DataSheet4U.com

Surface Mount Wirewound Resistors

SEI Type SRW

PERFORMANCE DATA

Temperature Rise Curves

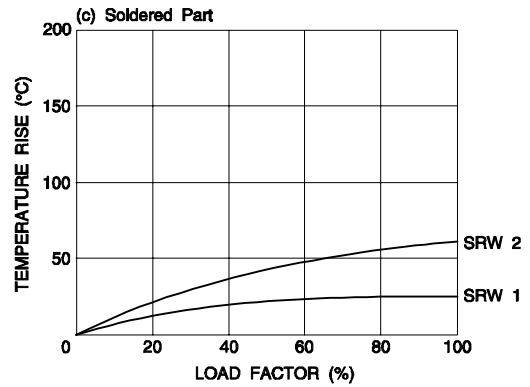
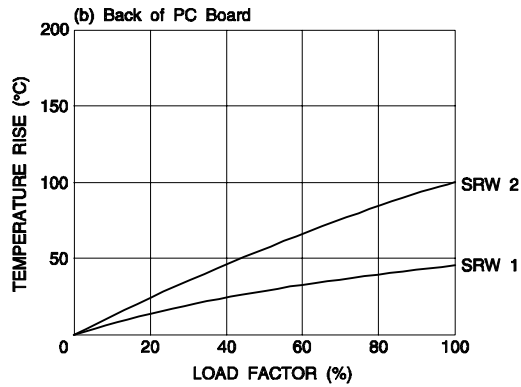
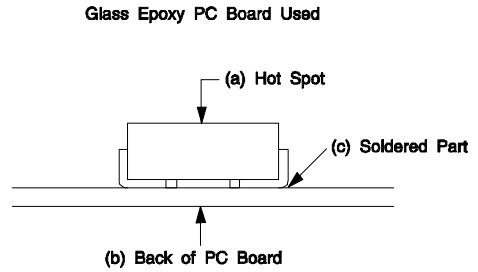
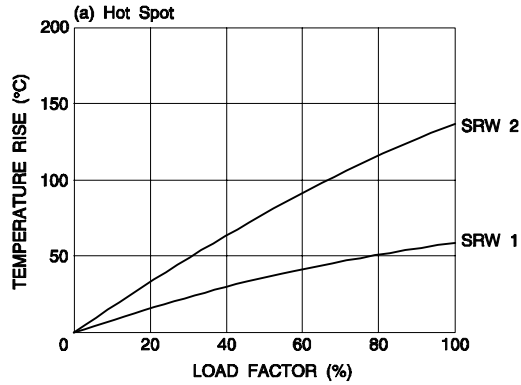

PACKAGING – Inches (mm)

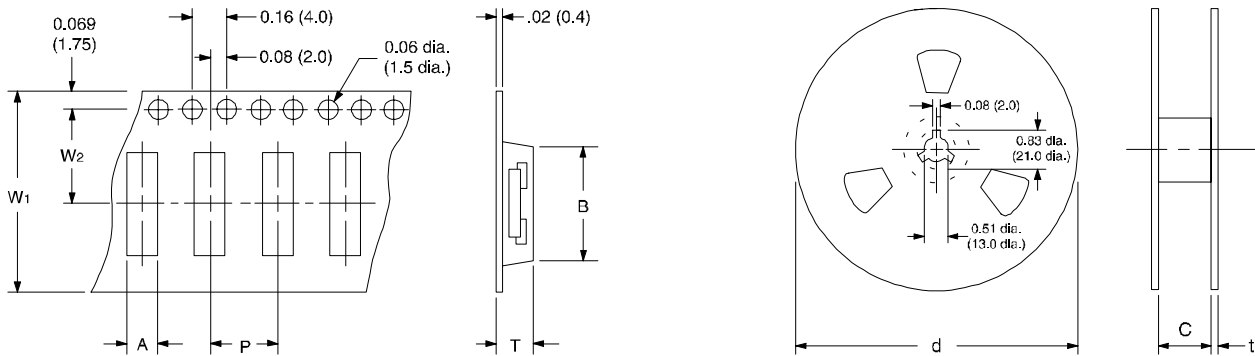

Packaging: 1,000 pc reel quantities

Style	A	B	W1	W2	P	T	d	C	t
SRW 1	0.20 (5.1)	0.32 (8.2)	0.63 (16.0)	0.30 (7.5)	0.31 (8.0)	0.16 (4.0)	13.0 (330)	0.69 (17.5)	0.06 (1.6)
SRW 2	0.26 (6.6)	0.52 (13.2)	0.94 (24.0)	0.45 (11.5)	0.31 (8.0)	0.18 (4.5)	13.0 (330)	1.00 (25.5)	0.06 (1.6)

www.DataSheet4U.com

Chip Resistor Array

SEI Type RAC

- Concave Termination
- Square Corner Construction
- Thick Film Ruthenium Oxide Element
- Multiple Circuit Types Available

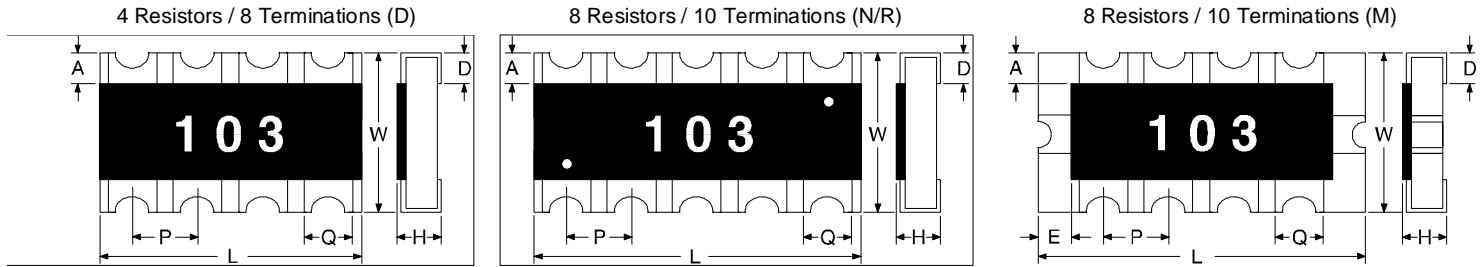

PERFORMANCE CHARACTERISTICS (TESTED PER MIL-STD-202)

ELECTRICAL	RAC 16-4D	RAC 32-4D	RAC 40-8M	RAC 64-8N/R
Power Rating (Watts) @ 70°C	0.063W / Element	0.125W / Element	0.063W / Element	0.063W / Element
Maximum Working Voltage	50V	75V	25V	50V
Maximum Overload Voltage	100V	150V	50V	100V
Tolerance	±5%, ±2% ³	±5%	±5%	±5%
Resistance Range	10Ω–1M	10Ω–1M	56Ω–220K	100Ω–470K
Resistance Temperature Coefficient	±200ppm/°C	±200ppm/°C	±200ppm/°C	±200ppm/°C
ENVIRONMENTAL	Per EIA-575 and JIS C5202			
Load Life in Moisture	±3.0%			
Temperature Cycle	±1.0%			
Load Life	±3.0%			
Resistance to Solder Heat	±1.0%			
Terminal Adhesion	±1.0%			
Short Time Overload	±2.0%			
Operating Temperature Range	-55°C to +125°C			

DIMENSIONS: Inches (mm)

FEATURE	RAC 16-4D	RAC 32-4D	RAC 40-8M	RAC 64-8N/R
L – Body Length	.126 ±.008 (3.20 ±0.20)	.200 ±.008 (5.08 ±0.20)	.157 ±.008 (4.00 ±0.20)	.252 ±.008 (6.40 ±0.20)
W – Body Width	.063 ±.006 (1.60 ±0.15)	.118 ±.008 (3.00 ±0.20)	.083 ±.008 (2.10 ±0.20)	.122 ±.008 (3.10 ±0.20)
H – Body Height	.024 ±.004 (0.60 ±0.10)	.024 ±.004 (0.60 ±0.10)	.024 ±.004 (0.60 ±0.10)	.024 ±.004 (0.60 ±0.10)
P – Element Spacing *	.032 (0.80)	.050 (1.27)	.032 (0.80)	.050 (1.27)
Q – Termination Width	.016 ±.006 (0.40 ±0.15)	.032 ±.004 (0.80 ±0.10)	.020 ±.008 (0.50 ±0.20)	.040 ±.008 (1.00 ±0.20)
D – Bottom Termination	.016 ±.008 (0.40 ±0.20)	.020 ±.008 (0.50 ±0.20)	.016 ±.008 (0.40 ±0.20)	.024 ±.008 (0.60 ±0.20)
A – Top Termination	.012 ±.008 (0.30 ±0.20)	.022 ±.008 (0.55 ±0.20)	.010 ±.008 (0.25 ±0.20)	.024 ±.008 (0.60 ±0.20)
E – End Termination	–	–	.012 ±.008 (0.30 ±0.20)	–
Circuit Schematic	D	D	M	N or R

* reference only

ORDERING INFORMATION

Type	Package Size	# Elements	Circuit Type	Resistance Value	Tolerance
RAC	16	4	D	10K	5%
		4 resistors	D = Isolated		
		8 resistors	M = Bussed		
			N = Bussed		
			R = Bussed		

NOTES

1. E24 Standard Values.
2. Zero ohm jumpers available in all sizes.
3. 39Ω minimum value.

Chip Resistor Array

SEI Type RAC

SCHEMATICS

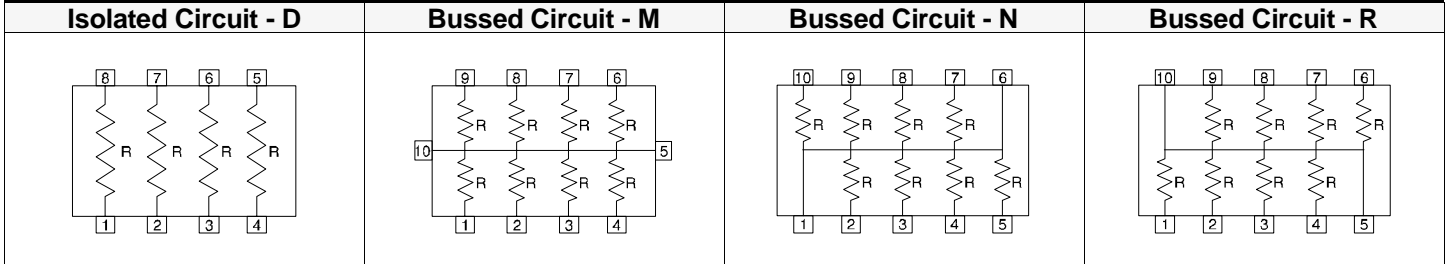

DERATING CURVE

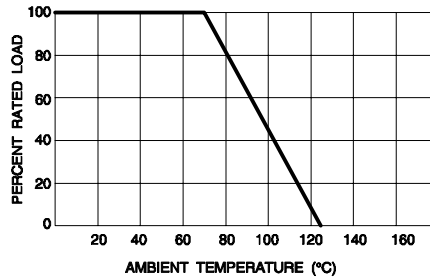

PACKAGING SPECIFICATIONS: Inch (mm)

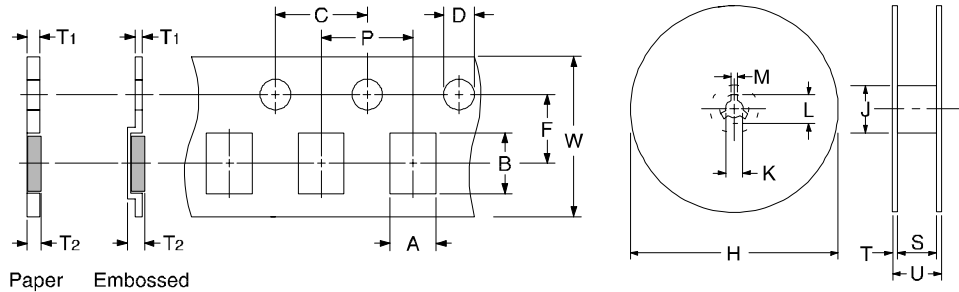

FEATURE	RAC 16-4D	RAC 32-4D	RAC 40-8M	RAC 64-8N/R
A – Pocket Width	.079 ±.008 (2.00 ±0.20)	.138 ±.004 (3.50 ±0.10)	.098 ±.004 (2.50 ±0.10)	.138 ±.004 (3.50 ±0.10)
B – Pocket Length	.142 ±.008 (3.60 ±0.20)	.224 ±.004 (5.70 ±0.10)	.173 ±.004 (4.40 ±0.10)	.266 ±.004 (6.75 ±0.10)
P – Pocket Spacing	.157 ±.004 (4.00 ±0.10)	.157 ±.004 (4.00 ±0.10)	.157 ±.004 (4.00 ±0.10)	.157 ±.004 (4.00 ±0.10)
C – Pin Spacing	.157 ±.004 (4.00 ±0.10)	.157 ±.004 (4.00 ±0.10)	.157 ±.004 (4.00 ±0.10)	.157 ±.004 (4.00 ±0.10)
D – Pin Diameter	.06 +.004/-0 (1.5 +0.1/-0)	.06 +.004/-0 (1.5 +0.1/-0)	.06 +.004/-0 (1.5 +0.1/-0)	.06 +.004/-0 (1.5 +0.1/-0)
F – Pin-to-Pocket Center	.138 ±.002 (3.50 ±0.05)	.217 ±.002 (5.50 ±0.05)	.217 ±.002 (5.50 ±0.05)	.217 ±.002 (5.50 ±0.05)
W – Strip Width	.315 ±.008 (8.00 ±0.20)	.472 ±.008 (12.00 ±0.20)	.472 ±.008 (12.00 ±0.20)	.472 ±.008 (12.00 ±0.20)
T1 – Strip Thickness	.02 max. (0.5 max.)	.010 ±.002 (0.25 ±0.05)	.010 ±.002 (0.25 ±0.05)	.010 ±.002 (0.25 ±0.05)
T2 – Total Thickness	.04 max. (1.0 max.)	.043 max. (1.10 max.)	.043 max. (1.10 max.)	.043 max. (1.10 max.)
Material	Paper	Embossed	Embossed	Embossed
Pieces/Reel	5,000	4,000	4,000	4,000
H – Reel Diameter	7.00 ±.08 (178.0 ±2.0)	7.09 +0/- .12 (180.0 +0/-3.0)	7.09 +0/- .12 (180.0 +0/-3.0)	7.09 +0/- .12 (180.0 +0/-3.0)
J – Hub Diameter	2.0 (50) approx.	2.4 +.04/-0 (60 +1.0/-0)	2.4 +.04/-0 (60 +1.0/-0)	2.4 +.04/-0 (60 +1.0/-0)
K – Hole Diameter	.51 ±.04 (13.0 ±1.0)	.51 ±.01 (13.0 ±0.2)	.51 ±.01 (13.0 ±0.2)	.51 ±.01 (13.0 ±0.2)
L – Key Diameter	.83 ±.04 (21.0 ±1.0)	.83 ±.03 (21.0 ±0.8)	.83 ±.03 (21.0 ±0.8)	.83 ±.03 (21.0 ±0.8)
M – Key Width	.08 ±.04 (2.0 ±1.0)	.08 ±.02 (2.0 ±0.5)	.08 ±.02 (2.0 ±0.5)	.08 ±.02 (2.0 ±0.5)
S – Reel Inside Width	.53 ±.08 (13.5 ±2.0)	.35 ±.01 (9.0 ±0.3)	.35 ±.01 (9.0 ±0.3)	.35 ±.01 (9.0 ±0.3)
T – Reel Side Thickness	.03 ±.01 (0.8 ±0.2)	–	–	–
U – Reel Outside Width	–	.45 ±.04 (11.4 ±1.0)	.45 ±.04 (11.4 ±1.0)	.45 ±.04 (11.4 ±1.0)

Chip Resistor Array

SEI Type RAV

- Convex Termination
- Square Corner Construction
- Thick Film Ruthenium Oxide Element
- Multiple Circuit Types Available

2 Resistors / 4 Terminations (D)

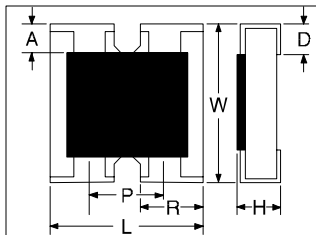

4 Resistors / 8 Terminations (D)

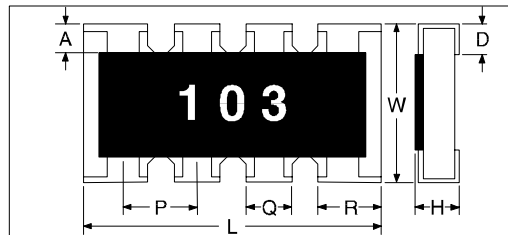

8 Resistors / 10 Terminations (N/R)

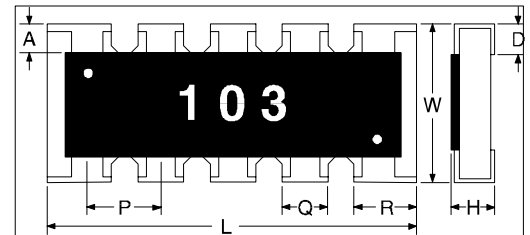

PERFORMANCE CHARACTERISTICS (TESTED PER MIL-STD-202)

ELECTRICAL	RAV 10-2D	RAV 10-4D	RAV 16-2D	RAV 16-4D	RAV 32-4D	RAV 32-8N/R
Power Rating (Watts) @ 70°C	0.031W /Element	0.031W /Element	0.063W /Element	0.063W /Element	0.125W /Element	0.031W /Element
Maximum Working Voltage	25V	25V	50V	50V	200V	25V
Maximum Overload Voltage	50V	50V	100V	100V	400V	50V
Tolerance	±5%	±5%	±5%	±5%	±5%	±5%
Resistance Range	10Ω-1M	10Ω-1M	10Ω-1M	10Ω-1M	10Ω-1M	100Ω-100K
Resistance Temperature Coefficient	±250ppm/°C	±250ppm/°C	±200ppm/°C	±200ppm/°C	±200ppm/°C	±250ppm/°C
ENVIRONMENTAL	Per EIA-575 and JIS C5202			NOTES		
Load Life in Moisture	±3.0%			1. E24 Standard Values.		
Temperature Cycle	±1.0%			2. Zero ohm jumpers available in all sizes.		
Load Life	±3.0%					
Resistance to Solder Heat	±1.0%					
Terminal Adhesion	±1.0%					
Short Time Overload	±2.0%					
Operating Temperature Range	-55°C to +125°C					

DIMENSIONS: Inches (mm)

FEATURE	RAV 10-2D	RAV 10-4D	RAV 16-2D	RAV 16-4D
L – Body Length	.039 ±.004 (1.00 ±0.10)	.079 ±.008 (2.00 ±0.20)	.063 ±.004 (1.60 ±0.10)	.126 ±.008 (3.20 ±0.20)
W – Body Width	.039 ±.004 (1.00 ±0.10)	.039 ±.006 (1.00 ±0.15)	.063 ±.004 (1.60 ±0.10)	.063 ±.004 (1.60 ±0.10)
H – Body Height	.014 ±.004 (0.35 ±0.10)	.014 ±.004 (0.35 ±0.10)	.020 ±.004 (0.50 ±0.10)	.020 ±.004 (0.50 ±0.10)
P – Element Spacing *	.026 (0.65)	.020 ±.006 (0.50 ±0.15)	.032 (0.80)	.032 (0.80)
Q – Termination Width	–	.012 ±.006 (0.30 ±0.15)	–	.016 ±.006 (0.40 ±0.15)
R – Termination Width	.013 ±.002 (0.33 ±0.05)	–	.020 ±.004 (0.50 ±0.10)	.024 ±.006 (0.60 ±0.15)
D – Bottom Termination	.010 ±.004 (0.25 ±0.10)	.010 ±.004 (0.25 ±0.10)	.010 ±.004 (0.25 ±0.10)	.010 ±.004 (0.25 ±0.10)
A – Top Termination	.006 (0.15)	.006 (0.15)	.006 (0.15)	.012 ±.008 (0.30 ±0.20)
Circuit Schematic	D	D	D	D

* reference only

ORDERING INFORMATION

Type	Package Size	# Elements	Circuit Type	Resistance Value	Tolerance
RAV	16	4	D	10K	5%
		2 resistors	D = Isolated		
		4 resistors	N = Bussed		
		8 resistors	R = Bussed		

FEATURE	RAV 32-4D	RAV 32-8N/R
L – Body Length	.200 ±.008 (5.08 ±0.20)	.126 ±.008 (3.20 ±0.20)
W – Body Width	.122 ±.008 (3.10 ±0.20)	.063 ±.008 (1.60 ±0.20)
H – Body Height	.022 ±.004 (0.55 ±0.10)	.020 ±.004 (0.50 ±0.10)
P – Element Spacing *	.050 (1.27)	.025 (0.64)
Q – Termination Width	.032 ±.008 (0.80 ±0.20)	.013 ±.006 (0.34 ±0.15)
R – Termination Width	.043 ±.006 (1.10 ±0.15)	.019 ±.006 (0.49 ±0.15)
D – Bottom Termination	.012 ±.008 (0.30 ±0.20)	.010 ±.004 (0.25 ±0.10)
A – Top Termination	–	.012 ±.008 (0.30 ±0.20)
Circuit Schematic	D	N or R

* reference only

Chip Resistor Array

SEI Type RAV

SCHEMATICS

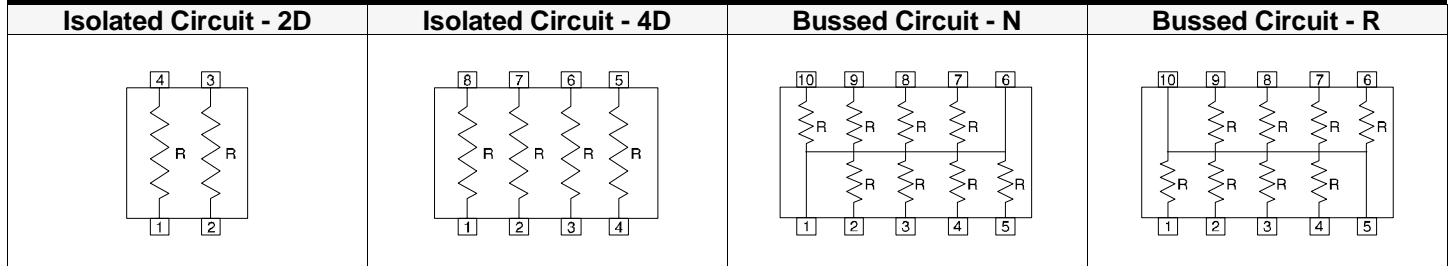

DERATING CURVE

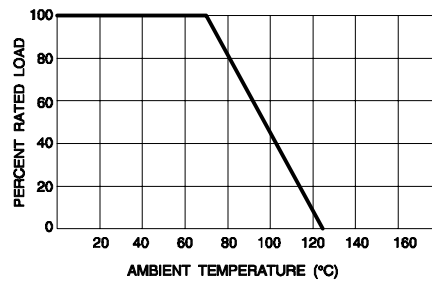

PACKAGING SPECIFICATIONS: Inch (mm)

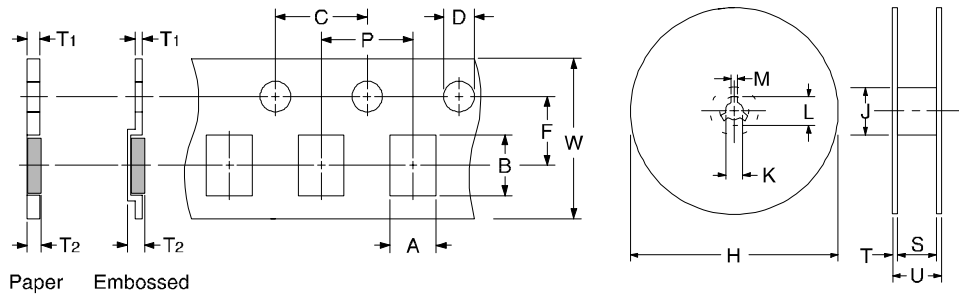

FEATURE	RAV 10-2D	RAV 10-4D	RAV 16-2D	RAV 16-4D & 32-8	RAV 32-4D
A – Pocket Width	.046 ±.004 (1.17 ±0.10)	.051 ±.008 (1.30 ±0.20)	.071 ±.004 (1.80 ±0.10)	.079 ±.008 (2.00 ±0.20)	.134 ±.004 (3.40 ±0.10)
B – Pocket Length	.046 ±.004 (1.17 ±0.10)	.091 ±.008 (2.30 ±0.20)	.071 ±.004 (1.80 ±0.10)	.142 ±.008 (3.60 ±0.20)	.220 ±.004 (5.60 ±0.10)
P – Pocket Spacing	.079 ±.002 (2.00 ±0.05)	.079 ±.002 (2.00 ±0.05)	.157 ±.004 (4.00 ±0.10)	.157 ±.004 (4.00 ±0.10)	.157 ±.004 (4.00 ±0.10)
C – Pin Spacing	.157 ±.004 (4.00 ±0.10)	.157 ±.004 (4.00 ±0.10)	.157 ±.004 (4.00 ±0.10)	.157 ±.004 (4.00 ±0.10)	.157 ±.004 (4.00 ±0.10)
D – Pin Diameter	.06 +.004/-0 (1.5)	.06 +.004/-0 (1.5)	.06 +.004/-0 (1.5)	.06 +.004/-0 (1.5)	.06 +.004/-0 (1.5)
F – Pin-Pocket C/L	+0.1/-0)	+0.1/-0)	+0.1/-0)	+0.1/-0)	+0.1/-0)
W – Strip Width	.138 ±.002 (3.50 ±0.05)	.138 ±.002 (3.50 ±0.05)	.138 ±.002 (3.50 ±0.05)	.138 ±.002 (3.50 ±0.05)	.217 ±.002 (5.50 ±0.05)
T1 – Strip Thickness	.315 ±.008 (8.00 ±0.20)	.315 ±.008 (8.00 ±0.20)	.315 ±.008 (8.00 ±0.20)	.315 ±.008 (8.00 ±0.20)	.472 ±.008 (12.00 ±0.20)
T2 – Total Thickness	.04 max. (1.0 max.) .06 max. (1.4 max.)	.04 max. (1.0 max.) .06 max. (1.4 max.)	.02 max. (0.5 max.) .04 max. (1.0 max.)	.04 max. (1.0 max.) .06 max. (1.4 max.)	.010 ±.002 (0.25 ±0.05) .043 max. (1.10 max.)
Material	Paper	Paper	Paper	Paper	Embossed
Pieces/Reel	10,000	10,000	5,000	5,000	4,000
H – Reel Diameter	7.00 ±.08 (178.0 ±2.0)	7.00 ±.08 (178.0 ±2.0)	7.00 ±.08 (178.0 ±2.0)	7.00 ±.08 (178.0 ±2.0)	7.1 +0/- .12 (180+0/-3.0)
J – Hub Diameter	2.0 (50) approx.	2.0 (50) approx.	2.0 (50) approx.	2.0 (50) approx.	2.4 +0.4/-0 (60 +1.0/-0)
K – Hole Diameter	.51 ±.04 (13.0 ±1.0)	.51 ±.04 (13.0 ±1.0)	.51 ±.04 (13.0 ±1.0)	.51 ±.04 (13.0 ±1.0)	.51 ±.01 (13.0 ±0.2)
L – Key Diameter	.83 ±.04 (21.0 ±1.0)	.83 ±.04 (21.0 ±1.0)	.83 ±.04 (21.0 ±1.0)	.83 ±.04 (21.0 ±1.0)	.83 ±.03 (21.0 ±0.8)
M – Key Width	.08 ±.04 (2.0 ±1.0)	.08 ±.04 (2.0 ±1.0)	.08 ±.04 (2.0 ±1.0)	.08 ±.04 (2.0 ±1.0)	.08 ±.02 (2.0 ±0.5)
S – Reel Inside Width	.53 ±.08 (13.5 ±2.0)	.53 ±.08 (13.5 ±2.0)	.53 ±.08 (13.5 ±2.0)	.53 ±.08 (13.5 ±2.0)	.35 ±.01 (9.0 ±0.3)
T – Side Thickness	.03 ±.01 (0.8 ±0.2)	.03 ±.01 (0.8 ±0.2)	.03 ±.01 (0.8 ±0.2)	.03 ±.01 (0.8 ±0.2)	–
U – Reel Outside Width	–	–	–	–	.45 ±.04 (11.4 ±1.0)

SEI Electronics Inc. • P.O. Box 58789 • Raleigh, NC 27658-8789 • Telephone: (919) 850-9500 • FAX: (919) 850-9504
 Toll Free: (888) SEI-SEI-SEI • www.seielect.com • email: marketing@seielect.com • ISO 9002 Registered

Thick Film Resistor Networks

Single Inline Package SEI Types LC & HC

- Low Profile Standard — High Profile Available
- 6, 8 or 10 Pins Standard — 4, 5, 7, 9, 11 or 12 Pin Available
- Copper Leads Standard — Steel Leads Optional
- Black Body Color, Conformal Coating

PERFORMANCE CHARACTERISTICS

ELECTRICAL	Low-Profile	High-Profile
Power Rating (Watts)	1/8W each resistor @ 70°C	1/5W each resistor @ 70°C
Derated to 0 Load at	125°C	125°C
Maximum Working Voltage	200V	200V
Operating Temperature Range	-55°C to +125°C	-55°C to +125°C
Resistance Range	22Ω – 1 meg	22Ω – 1 meg
Tolerance (%)	±2% ^{1,3}	±2% ^{1,3}
Temperature Coefficient	±100ppm/°C ²	±100ppm/°C ²
Temperature Coefficient of Resistance Tracking	<50ppm	<50ppm
Storage Temperature	-65°C to +150°C	-65°C to +150°C
ENVIRONMENTAL	Tested per MIL-R-83401 (%ΔR max.)	NOTES
Thermal Shock	±0.5%	1. ±1%, ±5% and ±10% tolerances available. 2. ±50ppm and ±200ppm T.C. available. 3. Below 100 ohm ±2 ohm is standard. For ±2% contact factory.
Low Temperature Operation	±0.5%	
Short Time Overload	±0.5%	
Moisture Resistance	±0.5%	
Load Life @ 70°C – 1,000 hours	±1%	
Resistance to Soldering Heat	±0.25%	
Terminal Strength	±0.25%	
Shock (Specified Pulse)	±0.25%	
Vibration (High Frequency)	±0.25%	

DIMENSIONS: Inches (mm)

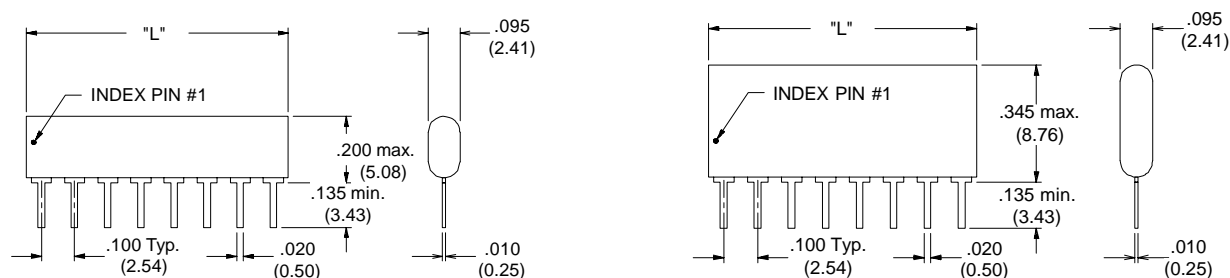

No. of Pins	"L" Max.
4	.390 (9.91)
5	.490 (12.45)
6	.590 (14.99)
7	.690 (17.53)
8	.790 (20.07)
9	.890 (22.61)
10	.990 (25.15)
11	1.090 (27.69)
12	1.190 (30.23)

www.DataSheet4U.com

Thick Film Resistor Networks

Single Inline Package

SEI Types LC & HC

STANDARD CONFIGURATIONS – LOW-PROFILE SIP PACKAGE

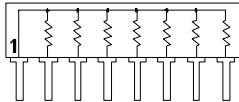

SINGLE COMMON
(BUSSED)
Pull-Up/Pull-Down

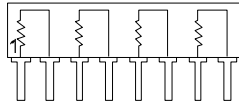

DISCRETE
(ISOLATED)
Terminator

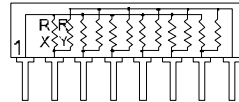

DUAL TERMINATION

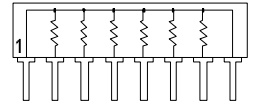

DUAL COMMON

STANDARD CONFIGURATIONS – HIGH-PROFILE SIP PACKAGE

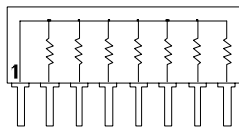

SINGLE COMMON
(BUSSED)
Pull-Up/Pull-Down

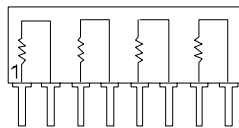

DISCRETE
(ISOLATED)
Terminator

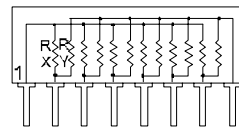

DUAL TERMINATION

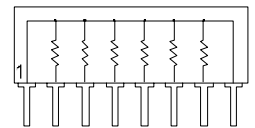

DUAL COMMON

ORDERING INFORMATION

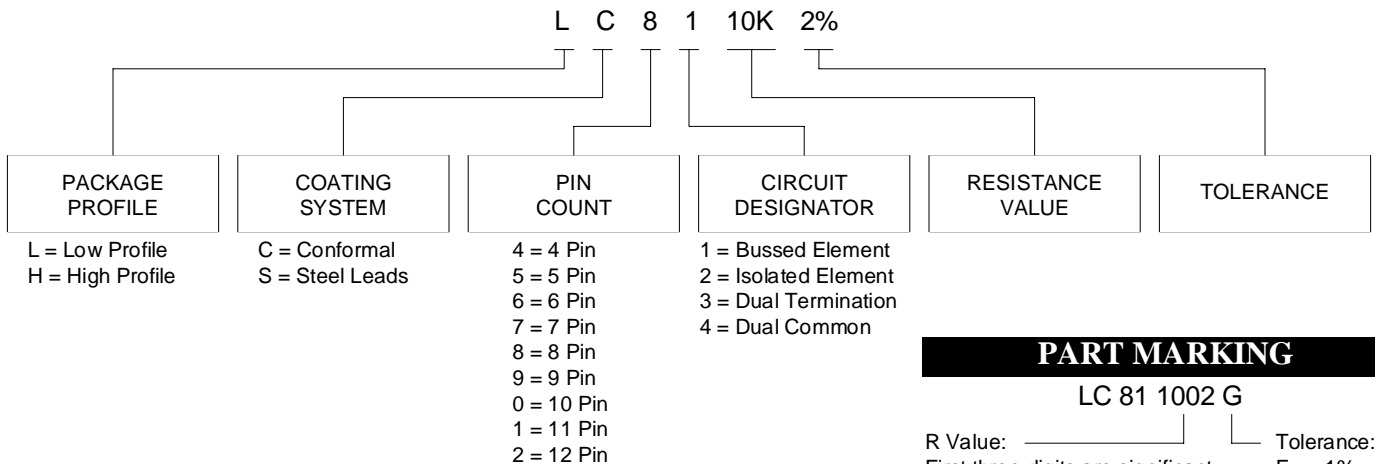

PART MARKING

LC 81 1002 G

R Value: _____ Tolerance: _____
 First three digits are significant figures. Fourth digit is multiplier.
 22R0 = 22 Ohm
 1000 = 100 Ohm
 1001 = 1 K Ohm
 1002 = 10 K Ohm
 1003 = 100 K Ohm
 1004 = 1 Megohm
 F = 1%
 G = 2%
 J = 5%
 M = 10%

Thick Film Resistor Networks

Single Inline Package – R/2R Ladder

SEI Type MC

- Medium Profile Standard
- 4, 6, 8, 10 or 12 Pins Standard
- Black Body Color, Conformal Coating

PERFORMANCE CHARACTERISTICS

ELECTRICAL	
Power Rating (Watts)	1/8W each resistor @ 70°C
Derated to 0 Load at	125°C
Maximum Working Voltage	100V
Operating Temperature Range	-55°C to +125°C
Resistance Range	22Ω – 1 meg
Tolerance (%)	±2%
Accuracy of Linearity	±1/2 LSB
Temperature Coefficient	±200ppm/°C
Temperature Coefficient of Resistance Tracking	<50ppm
Storage Temperature	-65°C to +150°C
ENVIRONMENTAL	
Tested per MIL-R-83401 (%ΔR max.)	
Thermal Shock	±0.5%
Low Temperature Operation	±0.25%
Short Time Overload	±0.5%
Moisture Resistance	±0.5%
Load Life @ 70°C – 1,000 hours	±1%
Resistance to Soldering Heat	±0.25%
Terminal Strength	±0.25%
Shock (Specified Pulse)	±0.25%
Vibration (High Frequency)	±0.25%

DIMENSIONS: Inches (mm)

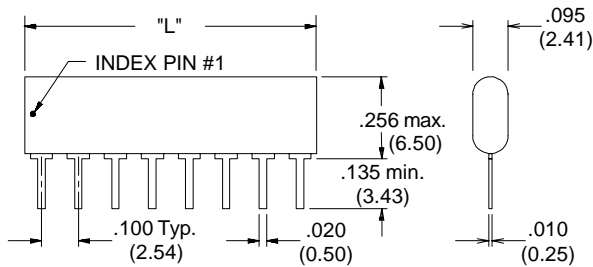

No. of Pins	"L" Max.
4	.390 (9.91)
6	.590 (14.99)
8	.790 (20.07)
10	.990 (25.15)
12	1.190 (30.23)

ORDERING INFORMATION

STANDARD CONFIGURATION

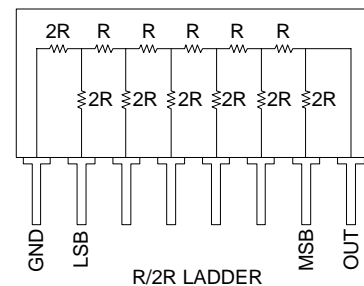
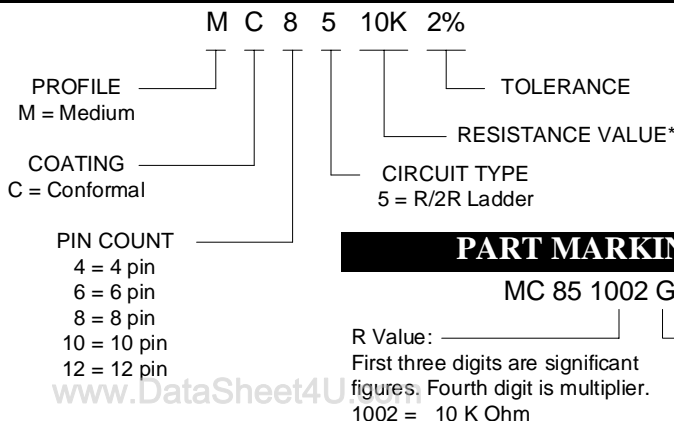

* Designate resistance value R when ordering.

Metal Film Resistors

SEI Type RN

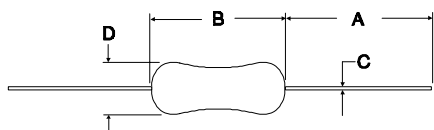

- Precision Metal Film
- Meets Requirements of MIL-R-10509
- Flame-retardant Coatings are Standard, Flame Proof Optional
- Pana-Sert Available (1/4W) – See F-2 for Specifications
- Blue Body Color

PERFORMANCE CHARACTERISTICS (TESTED PER MIL-STD-202)

ELECTRICAL	RN 1/8			RN 1/4			RN 1/2		
Power Rating (Watts)	1/8 @ 70°C (1/10 @ 125°C)			1/4 @ 70°C (1/8 @ 125°C)			1/2 @ 70°C (1/4 @ 125°C)		
Military Reference	RN 50			RN 55			RN 60		
Military Power Rating (Watts)	1/10 @ 70°C (1/20 @ 125°C)			1/8 @ 70°C (1/10 @ 125°C)			1/4 @ 70°C (1/8 @ 125°C)		
Maximum Working Voltage	200V			250V			350V		
Tolerance (%)	±1	±.5	±.25, ±.1	±1	±.5	±.25, ±.1	±1	±.5	±.25, ±.1
Resistance Range by T.C.	(T1) 10Ω–2.37M (T2) 10Ω–1M (T9) 49.9Ω–499K	10Ω–499K 10Ω–499K 49.9Ω–499K	100Ω–100K 100Ω–100K 100Ω–100K	10Ω–10M 10Ω–4.99M 30Ω–499K	10Ω–499K 10Ω–499K 30Ω–499K	30Ω–300K 30Ω–300K 30Ω–300K	10Ω–10M 10Ω–4.99M 49.9Ω–499K	10Ω–499K 10Ω–499K 49.9Ω–499K	100Ω–100K 100Ω–100K 100Ω–100K
Resistance Temperature Coefficient	±100ppm/°C (T1) ±50ppm/°C (T2) ±25ppm/°C (T9)			±100ppm/°C ±50ppm/°C ±25ppm/°C			±100ppm/°C ±50ppm/°C ±25ppm/°C		
Voltage Coefficient	±10 ppm/V			±10 ppm/V			±10 ppm/V		
Maximum Pulse Voltage	400V			500V			600V		
Insulation Resistance	10,000 meg min.			10,000 meg min.			10,000 meg min.		
ENVIRONMENTAL (%ΔR)	TYPICAL			MIL-R-10509		EIA RS-196			
				Char. D	Char. C	Class 1			
Moisture Resistance	±0.5			±1.5	±0.5	±1.5			
Thermal Shock	±0.25			±0.5	±0.25	—			
Load Life @ 70°C — 1,000 hrs	±0.5			±1.0	±0.5	±2.0			
Shock and Vibration	±0.25			±0.5	±0.25	—			
Resistance to Soldering Heat	±0.1			±0.5	±0.1	—			
Terminal Strength	±0.2			±0.2	±0.2	—			
Dielectric Withstand Voltage	±0.25			±0.5	±0.25	±0.5			
Short Time Overload	±0.25			±0.5	±0.25	±0.5			
Operating Temperature Range	-55°C to +165°C			-55°C to +165°C	-55°C to +175°C	—			

DIMENSIONS: Inches (mm)

FEATURE	RN 1/8	RN 1/4	RN 1/2
A – Lead Length (typ.) ⁶	1.10 ±.08 (28.0 ±2.0)	1.10 ±.08 (28.0 ±2.0)	1.10 ±.08 (28.0 ±2.0)
B – Body Length	.13 +.01/-0 (3.2 +0.2/-0)	.24 ±.01 (6.0 ±0.3)	.33 ±.02 (8.5 ±0.5)
C – Lead Diameter	.018 ±.002 (0.45 ±0.05)	.023 ±.002 (0.60 ±0.05)	.027 ±.002 (0.70 ±0.05)
D – Body Diameter	.073 ±.006 (1.85 ±0.15)	.09 ±.01 (2.4 ±0.2)	.11 ±.01 (2.8 ±0.3)

ORDERING INFORMATION

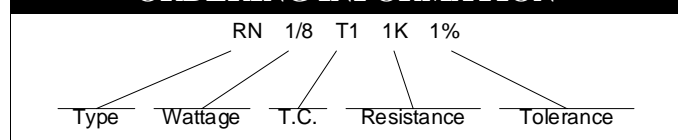

www.DataSheet4U.com

NOTES

1. 1Ω-9.76Ω available. See page C-4.
2. Cut and formed leads available (see Section F).
3. T2 marking – red dash between 4th & 5th bands.
4. T9 marking – white dash between 4th & 5th bands.
5. TC marking only on RN 1/4 & RN 1/2.
6. Dimensions are for bulk packaged product only.

Metal Film Mini Series Resistors

SEI Type RNM

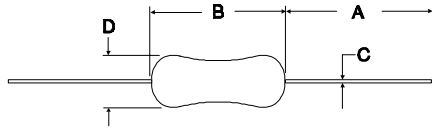

- Precision Metal Film
- Ideal Substitute Where Size Restraints Apply¹
- Meets Requirements of MIL-R-10509
- 10 ohm – 1 megohm Resistance Range
- Flame-retardant Coatings are Standard
- Temperature Coefficients from ± 50 to ± 100 ppm/ $^{\circ}$ C
- Blue Body Color
- Pana-Sert Available (1/2W) – See F-2 for Specifications

PERFORMANCE CHARACTERISTICS (TESTED PER MIL-STD-202)

ELECTRICAL		RNM 1/4			RNM 1/2		
Power Rating (Watts)		1/4 @ 70°C (1/8 @ 125°C)			1/2 @ 70°C (1/4 @ 125°C)		
Maximum Working Voltage		250V			350V		
Tolerance ⁶	(%)	± 1	$\pm .5$	$\pm .25, \pm 1$	± 1	$\pm .5$	$\pm .25, \pm 1$
Resistance Range by T.C.	(T1)	10 Ω –2.15M	10 Ω –499K	100 Ω –100K	10 Ω –10M	10 Ω –499K	100 Ω –100K
	(T2)	10 Ω –1M	10 Ω –499K	100 Ω –100K	10 Ω –2.15M	10 Ω –499K	100 Ω –100K
	(T9)	49.9 Ω –1M	49.9 Ω –499K	100 Ω –100K	49.9 Ω –499K	49.9 Ω –499K	100 Ω –100K
Resistance Temperature Coefficient	(T1) ²	± 100 ppm/ $^{\circ}$ C			± 100 ppm/ $^{\circ}$ C		
	(T2) ³	± 50 ppm/ $^{\circ}$ C			± 50 ppm/ $^{\circ}$ C		
	(T9) ⁴	± 25 ppm/ $^{\circ}$ C			± 25 ppm/ $^{\circ}$ C		
Voltage Coefficient		± 10 ppm/V			± 10 ppm/V		
Maximum Pulse Voltage		400V			500V		
Insulation Resistance		10,000 meg min.			10,000 meg min.		
ENVIRONMENTAL (% Δ R)	TYPICAL	MIL-R-10509		EIA RS-196			
		Char. D	Char. C	Class 1			
Moisture Resistance	± 0.5	± 1.5	± 0.5	± 1.5			
Thermal Shock	± 0.25	± 0.5	± 0.25	—			
Load Life @ 70°C — 1,000 hrs	± 0.5	± 1.0	± 0.5	± 2.0			
Shock and Vibration	± 0.25	± 0.5	± 0.25	—			
Resistance to Soldering Heat	± 0.1	± 0.5	± 0.1	—			
Terminal Strength	± 0.2	± 0.2	± 0.2	—			
Dielectric Withstand Voltage	± 0.25	± 0.5	± 0.25	± 0.5			
Short Time Overload	± 0.25	± 0.5	± 0.25	± 0.5			
Operating Temperature Range	-55°C to +165°C	-55°C to +165°C	-55°C to +175°C	—			

DIMENSIONS: Inches (mm)

FEATURE	RNM 1/4	RNM 1/2
A – Lead Length (typ.)	1.10 \pm .08 (28.0 \pm 2.0)	1.10 \pm .08 (28.0 \pm 2.0)
B – Body Length	.13 \pm .01/-0 (3.2 \pm 0.2/-0)	.24 \pm .01 (6.0 \pm 0.3)
C – Lead Diameter	.018 \pm .002 (0.45 \pm 0.05)	.023 \pm .002 (0.60 \pm 0.05)
D – Body Diameter	.073 \pm .006 (1.85 \pm 0.15)	.09 \pm .01 (2.4 \pm 0.2)

ORDERING INFORMATION

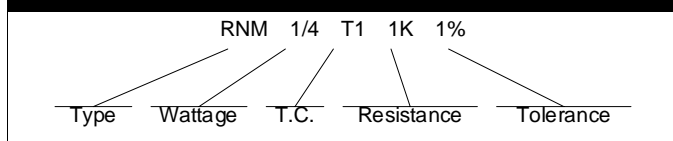

NOTES

1. 1/2W rating in 1/4W package size and 1/4W rating in 1/8W size.
2. T1 marking – black dash between 4th & 5th bands.
3. T2 marking – green dash between 4th & 5th bands.
4. T9 marking – silver dot on body.
5. Cut and formed leads available (see Section F).

www.DataSheet4U.com

Metal Film Resistors

SEI Type MP

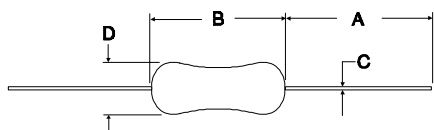

- General Purpose Metal Film
- Meets Requirements of MIL-R-22684
- Flame-retardant Coatings are Standard
- Temperature Coefficient of $\pm 100\text{ppm}/^\circ\text{C}$
- Resistance Range Tolerance of $\pm 2\%$ and $\pm 5\%$
- Blue Body Color

PERFORMANCE CHARACTERISTICS (TESTED PER MIL-STD-202)

ELECTRICAL	MP 1/8	MP 1/4	MP 1/2
Power Rating (Watts)	1/8 @ 70°C	1/4 @ 70°C	1/2 @ 70°C
Military Reference	RL 05	RL 07	RL 20
Maximum Working Voltage	200V	250V	350V
Tolerance (%)	$\pm 2, \pm 5$	$\pm 2, \pm 5$	$\pm 2, \pm 5$
Resistance Range	10 Ω –2.2M	10 Ω –10M	10 Ω –10M
Resistance Temperature Coefficient	$\pm 100\text{ppm}/^\circ\text{C}$	$\pm 100\text{ppm}/^\circ\text{C}$	$\pm 100\text{ppm}/^\circ\text{C}$
Voltage Coefficient	$\pm 10\text{ ppm}/\text{V}$	$\pm 10\text{ ppm}/\text{V}$	$\pm 10\text{ ppm}/\text{V}$
Maximum Pulse Voltage	400V	500V	600V
Insulation Resistance	10,000 meg min.	10,000 meg min.	10,000 meg min.
ENVIRONMENTAL (% Δ R)	TYPICAL	MIL-R-22684(RL)	EIA RS-196 Class 1
Moisture Resistance	± 0.5	± 1.5	± 1.5
Thermal Shock	± 0.25	± 0.5	—
Load Life @ 70°C — 1,000 hrs	± 0.5	± 2.0	± 2.0
Shock and Vibration	± 0.25	± 0.5	—
Resistance to Soldering Heat	± 0.1	± 0.5	—
Terminal Strength	± 0.2	± 0.2	—
Dielectric Withstand Voltage	± 0.25	± 0.5	± 0.5
Short Time Overload	± 0.25	± 0.5	± 0.5
Operating Temperature Range	-55°C to +155°C		

DIMENSIONS: Inches (mm)

FEATURE	MP 1/8	MP 1/4	MP 1/2
A – Lead Length (typ.)	1.10 \pm 0.08 (28.0 \pm 2.0)	1.10 \pm 0.08 (28.0 \pm 2.0)	1.10 \pm 0.08 (28.0 \pm 2.0)
B – Body Length	.13 \pm .01/-0 (3.2 \pm 0.2/-0)	.24 \pm .01 (6.0 \pm 0.3)	.33 \pm .02 (8.5 \pm 0.5)
C – Lead Diameter	.018 \pm .002 (0.45 \pm 0.05)	.023 \pm .002 (0.60 \pm 0.05)	.027 \pm .002 (0.70 \pm 0.05)
D – Body Diameter	.073 \pm .006 (1.85 \pm 0.15)	.09 \pm .01 (2.4 \pm 0.2)	.11 \pm .01 (2.8 \pm 0.3)

ORDERING INFORMATION

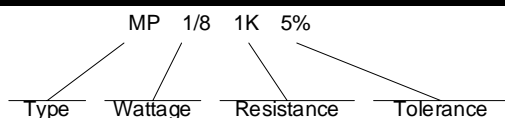

NOTES

1. Cut and formed leads available (see Section F).
2. Mini Series Type MPM available – please consult factory.

www.DataSheet4U.com

SEI Electronics Inc. • P.O. Box 58789 • Raleigh, NC 27658-8789 • Telephone: (919) 850-9500 • FAX: (919) 850-9504
Toll Free: (888) SEI-SEI-SEI • www.seielect.com • email: marketing@seielect.com • ISO 9002 Registered

Low Value Metal Film Resistors

SEI Type LV

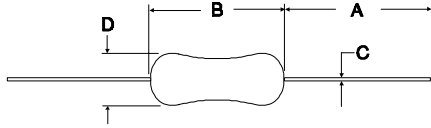

- Precision Performance
- 1 ohm – 9.76 ohm Resistance Range
- Temperature Coefficients of $\pm 100\text{ppm}/^\circ\text{C}$ (Standard) and $\pm 50\text{ppm}/^\circ\text{C}$ Available
- Replacement Potential of Low Value Wirewounds
- $\pm 1\%$ Tolerance is Standard – $\pm 2\%$ and $\pm 5\%$ Available
- Flame-retardant Coatings are Standard
- Blue Body Color
- Pana-Sert Available (1/4W) – See F-2 for Specifications

PERFORMANCE CHARACTERISTICS (TESTED PER MIL-STD-202)

ELECTRICAL	LV 1/4	LV 1/2
Power Rating (Watts)	1/4 @70°C	1/2
Derated to 0 Load at	155°C	155°C
Maximum Working Voltage	250V	350V
Operating Temperature Range	-55°C to +155°C	-55°C to +155°C
Resistance Range	1Ω – 9.76Ω	1Ω – 9.76Ω
Resistance Tolerance	$\pm 1\%$, $\pm 2\%$, $\pm 5\%$	$\pm 1\%$
Resistance Temperature (T1) Coefficient (T2)	$\pm 100\text{ppm}/^\circ\text{C}$ $\pm 50\text{ppm}/^\circ\text{C}^1$	$\pm 100\text{ppm}/^\circ\text{C}$ $\pm 50\text{ppm}/^\circ\text{C}^1$
ENVIRONMENTAL		
Moisture Resistance	$\pm 1.5\%$	$\pm 1.5\%$
Temperature Cycling	$\pm 0.35\%$	$\pm 0.35\%$
Load Life @ 70°C — 1,000 hrs	$\pm 1.0\%$	$\pm 1.0\%$
Low Temp. Operation	$\pm 0.35\%$	$\pm 0.35\%$
STOL	$\pm 0.25\%$	$\pm 0.25\%$
Effect of Soldering	$\pm 0.3\%$	$\pm 0.3\%$

DIMENSIONS: Inches (mm)

FEATURE	LV 1/4	LV 1/2
A – Lead Length (typ.)	1.10 \pm .08 (28.0 \pm 2.0)	1.10 \pm .08 (28.0 \pm 2.0)
B – Body Length	.24 \pm .01 (6.0 \pm 0.3)	.33 \pm .02 (8.5 \pm 0.5)
C – Lead Diameter	.023 \pm .002 (0.60 \pm 0.05)	.027 \pm .002 (0.70 \pm 0.05)
D – Body Diameter	.09 \pm .01 (2.4 \pm 0.2)	.11 \pm .01 (2.8 \pm 0.3)

ORDERING INFORMATION

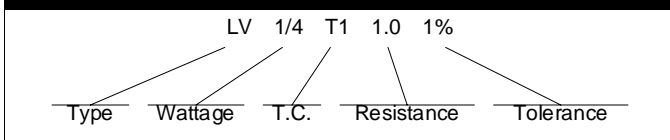

NOTES

1. T2 marking – red dash between 4th & 5th bands.
2. Cut and formed leads available (see Section F).
3. 1/2W mini size available.

Fusing Resistors

SEI Type FRN

- Coating Meets UL 94V-0
- Flameproof – Meets Overload Test of UL #1412
- Consistent Performance and Reliability

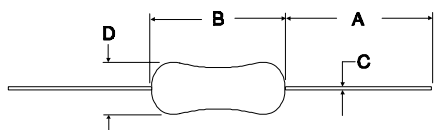

PERFORMANCE CHARACTERISTICS (TESTED PER MIL-R-22684)

ELECTRICAL	FRN 1/4	FRN 1/2	FRN 1	FRN 2
Power Rating (Watts)	1/4 @ 70°C	1/2 @ 70°C	1 @ 70°C	2 @ 70°C
Maximum Overload Voltage	300V	400V	600V	600V
Maximum Working Voltage	200V	250V	300V	300V
Operating Temperature Range	-40°C to +155°C	-40°C to +155°C	-40°C to +155°C	-40°C to +155°C
Resistance Range ^{1,2}	0.22Ω – 10K	0.47Ω – 10K	0.47Ω – 10K	1.0Ω – 3K
Tolerance	±5%	±5%	±5%	±5%
ENVIRONMENTAL (Operating Temperature Range: -40°C to +155°C)				
Moisture Resistance	±3%	±3%	±3%	±3%
Thermal Shock	±1%	±1%	±1%	±1%
Load Life @ 70°C – 1,000 hrs	±3%	±3%	±3%	±3%
Resistance Temperature Coefficient	0.22Ω – 9.1Ω ±500ppm/°C 10Ω – 10K ±300ppm/°C	0.22Ω – 9.1Ω ±500ppm/°C 10Ω – 10K ±300ppm/°C	0.22Ω – 9.1Ω ±500ppm/°C 10Ω – 10K ±300ppm/°C	0.22Ω – 9.1Ω ±500ppm/°C 10Ω – 10K ±300ppm/°C
Resistance to Soldering Heat Short Time Overload	±1% ±2%	±1% ±2%	±1% ±2%	±1% ±2%

FUSING CHARACTERISTICS

TYPE	MAGNIFICATION OF POWER RATING					FUSING TIME
	x30	x25	x18	x15	x12	
Characteristic	F	E	D	C	B	30 sec. MAX.
FRN 1/4	0.22Ω – 0.43Ω	0.47Ω – 0.91Ω	—	1Ω – 4.7Ω 2.4K – 10K	5.1Ω – 2.2K	
FRN 1/2	—	—	—	0.47Ω – 2Ω 1.1K – 10K	2.2Ω – 1K	
FRN 1	—	—	—	0.47Ω – 2Ω 1.1K – 10K	2.2Ω – 1K	
FRN 2	—	—	1Ω – 3.6Ω	1.1K – 3K	3.9Ω – 1K	

DIMENSIONS: Inches (mm)

FEATURE	FRN 1/4	FRN 1/2	FRN 1	FRN 2
A – Lead Length (typ.)	1.10 ±.08 (28.0 ±2.0)	1.10 ±.08 (28.0 ±2.0)	1.10 ±.08 (28.0 ±2.0)	1.38 ±.12 (35.0 ±3.0)
B – Body Length	.24 ±.01 (6.0 ±0.3)	.35 ±.02 (9.0 ±0.5)	.43 ±.02 (11.0 ±0.5)	.59 ±.04 (15.0 ±1.0)
C – Lead Diameter	.022±.002 (0.55±0.05)	.028±.002 (0.70±0.05)	.028±.002 (0.70±0.05)	.031±.002(0.80±0.05)
D – Body Diameter	.09 ±.01 (2.3 ±0.2)	.11 ±.02 (2.8 ±0.5)	.16 ±.02 (4.0 ±0.5)	.22 ±.02 (5.5 ±0.5)

ORDERING INFORMATION

FRN	1/2	10M	5%	B
Type	Wattage	Resistance	Tolerance	Fusing Char.

NOTES

1. Tape and reel packaging per RS-296.
2. E24 values for 5%.

www.DataSheet4U.com

Metal Film Resistors

Performance Curves/Construction

PERFORMANCE CURVES

High-Frequency Characteristics (Typical)

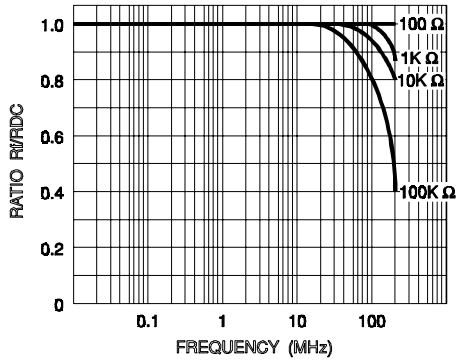

Derating Curve (Typical)

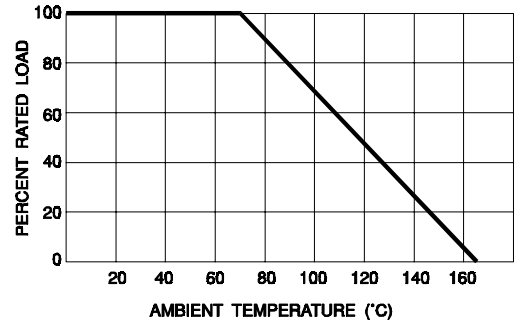

Current Noise (Typical)

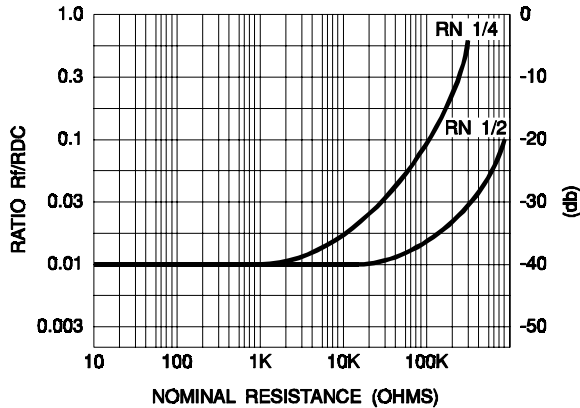

CONSTRUCTION

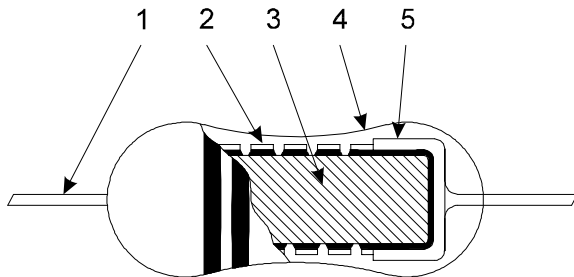

1. LEADS. Tinned copper leads.
2. METAL FILM. Evaporated metal film.
3. CERAMIC. Specially developed ceramic substrate.
4. EPOXY COATING. Conformal epoxy coating.
5. END CAP. End caps expansion fitted.

The average voltage coefficient is less than $\pm 10\text{ppm/V}$ between one-tenth and full-rated voltage.

The average change of resistance is less than 0.1% over a one-year period.

www.DataSheet4U.com

Metal Oxide Resistors

SEI Type RS

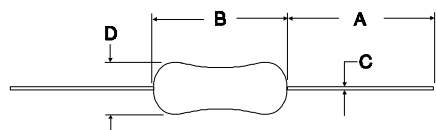

- Low Cost Alternative for Power Carbon Composition and Wirewounds
- Flameproof – Meets Overload Test of UL #1412
- Meets Solvent Test of Method 215 of MIL-STD-202
- Temperature Coefficient of ± 200 ppm/ $^{\circ}$ C
- Blue Body Color
- Coating Meets UL 94V-0

PERFORMANCE CHARACTERISTICS (TESTED PER MIL-R-22684)

ELECTRICAL	RS 1/2	RS 1	RS 2	RS 3	RS 5
Power Rating (Watts) Derated to 0 Load at Maximum Working Voltage	1/2 @70°C 200°C 250V	1 @70°C 200°C 350V	2 @70°C 200°C 350V	3 @70°C 200°C 500V	5 @70°C 200°C 750V
Operating Temperature Range Tolerance	-55°C to +200°C $\pm 5\%$ and $\pm 1\%$	-55°C to +200°C $\pm 5\%$ and $\pm 1\%$	-55°C to +200°C $\pm 5\%$ and $\pm 1\%$	-55°C to +200°C $\pm 5\%$ and $\pm 2\%$	-55°C to +200°C $\pm 5\%$ and $\pm 2\%$
Resistance Range ¹	0.1 Ω – 75K ($\pm 5\%$) 0.1 Ω – 75K ($\pm 1\%$)	0.1 Ω – 120K ($\pm 5\%$) 0.1 Ω – 100K ($\pm 1\%$)	0.1 Ω – 150K ($\pm 5\%$) 0.1 Ω – 120K ($\pm 1\%$)	1 Ω – 150K ($\pm 5\%$) 10 Ω – 10K ($\pm 2\%$)	1 Ω – 180K ($\pm 5\%$) 10 Ω – 10K ($\pm 2\%$)
Dielectric Withstand Voltage ² Maximum Pulse Voltage Insulation Resistance (Dry) (Wet) ³	400 volts RMS 400V 10,000 meg min. 100 meg min.	700 volts RMS 750V 10,000 meg min. 100 meg min.	700 volts RMS 1000V 10,000 meg min. 100 meg min.	800 volts RMS 1500V 10,000 meg min. 100 meg min.	800 volts RMS 1500V 10,000 meg min. 100 meg min.
ENVIRONMENTAL (Operating Temperature Range: -55°C to +200°C)					
Moisture Resistance Thermal Shock Load Life @ 70°C — 1,000 hrs	$\pm 1.5\%$ $\pm 1\%$ $\pm 2\%$	$\pm 1.5\%$ $\pm 1\%$ $\pm 2\%$	$\pm 1.5\%$ $\pm 1\%$ $\pm 2\%$	$\pm 1.5\%$ $\pm 1\%$ $\pm 2\%$	$\pm 1.5\%$ $\pm 1\%$ $\pm 2\%$
Shock and Vibration Resistance to Soldering Heat Terminal Strength	$\pm 0.5\%$ $\pm (0.5\% + 0.05\Omega)$ $\pm 0.5\%$	$\pm 0.5\%$ $\pm (0.5\% + 0.05\Omega)$ $\pm 0.5\%$	$\pm 0.5\%$ $\pm (0.5\% + 0.05\Omega)$ $\pm 0.5\%$	$\pm 0.5\%$ $\pm (0.5\% + 0.05\Omega)$ $\pm 0.5\%$	$\pm 0.5\%$ $\pm (0.5\% + 0.05\Omega)$ $\pm 0.5\%$
Voltage Coefficient Short Time Overload Low Temperature Operation	.001%/V $\pm (0.5\% + 0.05\Omega)$ $\pm 0.5\%$.001%/V $\pm (0.5\% + 0.05\Omega)$ $\pm 0.5\%$.001%/V $\pm (0.5\% + 0.05\Omega)$ $\pm 0.5\%$.001%/V $\pm (0.5\% + 0.05\Omega)$ $\pm 0.5\%$.001%/V $\pm (0.5\% + 0.05\Omega)$ $\pm 0.5\%$

DIMENSIONS: Inches (mm)

FEATURE	RS 1/2	RS 1	RS 2	RS 3	RS 5
A – Lead Length (typ.)	1.10 \pm .08 (28.0 \pm 2.0)	1.10 \pm .08 (28.0 \pm 2.0)	1.50 \pm .12 (38.0 \pm 3.0)	1.50 \pm .12 (38.0 \pm 3.0)	1.50 \pm .12 (38.0 \pm 3.0)
B – Body Length	.35 \pm .02 (9.0 \pm 0.5)	.43 \pm .02 (11.0 \pm 0.5)	.59 \pm .02 (15.0 \pm 0.5)	.98 \pm .08 (25.0 \pm 2.0)	1.61 \pm .08 (41.0 \pm 2.0)
C – Lead Diameter	.028 \pm .002 (0.70 \pm 0.05)	.031 \pm .002 (0.80 \pm 0.05)	.031 \pm .002 (0.80 \pm 0.05)	.031 \pm .002 (0.80 \pm 0.05)	.031 \pm .002 (0.80 \pm 0.05)
D – Body Diameter	.12 \pm .02 (3.0 \pm 0.5)	.16 \pm .02 (4.0 \pm 0.5)	.22 \pm .02 (5.5 \pm 0.5)	.34 \pm .06 (8.5 \pm 1.5)	.34 \pm .06 (8.5 \pm 1.5)

ORDERING INFORMATION

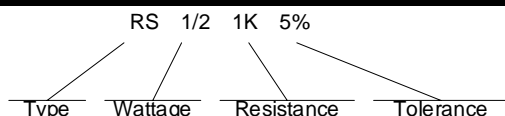

NOTES

1. E96 values for 1%, E24 values for 5%
2. $\pm 0.5\%$
3. After moisture resistance.
4. Available with swaged leads (see Section F).

Metal Oxide Mini Series Resistors

SEI Type RSM

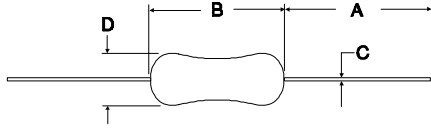

- Ideal Substitute Where Size Restraints Apply¹
- Low Cost Alternative for Power Carbon Composition and Wirewounds
- Flameproof – Meets Overload Test of UL #1412
- Meets Solvent Test of Method 215 of MIL-STD-202
- Temperature Coefficient of ± 200 ppm/ $^{\circ}$ C
- Green Body Color
- Coating Meets UL 94V-0

PERFORMANCE CHARACTERISTICS (TESTED PER MIL-R-22684)

ELECTRICAL	RSM 1/2	RSM 1	RSM 2	RSM 3	RSM 5
Power Rating (Watts) Derated to 0 Load at Maximum Working Voltage	1/2 @70°C 200°C 250V	1 @70°C 200°C 350V	2 @70°C 200°C 350V	3 @70°C 200°C 350V	5 @70°C 200°C 500V
Operating Temperature Range Tolerance	-55°C to +200°C $\pm 5\%$ and $\pm 1\%$	-55°C to +200°C $\pm 5\%$ and $\pm 1\%$	-55°C to +200°C $\pm 5\%$ and $\pm 1\%$	-55°C to +200°C $\pm 5\%$ and $\pm 1\%$ ³	-55°C to +200°C $\pm 5\%$ and $\pm 1\%$ ³
Resistance Range ²	0.1 Ω – 47K ($\pm 5\%$) 0.1 Ω – 47K ($\pm 1\%$)	0.1 Ω – 75K ($\pm 5\%$) 0.1 Ω – 75K ($\pm 1\%$)	0.1 Ω – 100K ($\pm 5\%$) 0.1 Ω – 100K ($\pm 1\%$)	0.1 Ω – 120K ($\pm 5\%$) 0.1 Ω – 120K ($\pm 1\%$)	1 Ω – 150K ($\pm 5\%$) 100 Ω – 4.99K ($\pm 1\%$)
Dielectric Withstand Voltage ³ Maximum Pulse Voltage Insulation Resistance (Dry) (Wet) ⁴	400 volts RMS 400V 10,000 meg min. 100 meg min.	600 volts RMS 750V 10,000 meg min. 100 meg min.	600 volts RMS 750V 10,000 meg min. 100 meg min.	600 volts RMS 750V 10,000 meg min. 100 meg min.	800 volts RMS 1000V 10,000 meg min. 100 meg min.
ENVIRONMENTAL (Operating Temperature Range: -55°C to +200°C)					
Moisture Resistance Thermal Shock Load Life @ 70°C — 1,000 hrs	$\pm 1.5\%$ $\pm 1\%$ $\pm 2\%$	$\pm 1.5\%$ $\pm 1\%$ $\pm 2\%$	$\pm 1.5\%$ $\pm 1\%$ $\pm 2\%$	$\pm 1.5\%$ $\pm 1\%$ $\pm 2\%$	$\pm 1.5\%$ $\pm 1\%$ $\pm 2\%$
Shock and Vibration Resistance to Soldering Heat Terminal Strength	$\pm 0.5\%$ $\pm (0.5\% + 0.05\Omega)$ $\pm 0.5\%$	$\pm 0.5\%$ $\pm (0.5\% + 0.05\Omega)$ $\pm 0.5\%$	$\pm 0.5\%$ $\pm (0.5\% + 0.05\Omega)$ $\pm 0.5\%$	$\pm 0.5\%$ $\pm (0.5\% + 0.05\Omega)$ $\pm 0.5\%$	$\pm 0.5\%$ $\pm (0.5\% + 0.05\Omega)$ $\pm 0.5\%$
Voltage Coefficient Short Time Overload Low Temperature Operation	.001%/V $\pm (0.5\% + 0.05\Omega)$ $\pm 0.5\%$.001%/V $\pm (0.5\% + 0.05\Omega)$ $\pm 0.5\%$.001%/V $\pm (0.5\% + 0.05\Omega)$ $\pm 0.5\%$.001%/V $\pm (0.5\% + 0.05\Omega)$ $\pm 0.5\%$.001%/V $\pm (0.5\% + 0.05\Omega)$ $\pm 0.5\%$

DIMENSIONS: Inches (mm)

FEATURE	RSM 1/2	RSM 1	RSM 2	RSM 3	RSM 5
A – Lead Length (typ.)	1.10 \pm .08 (28.0 \pm 2.0)	1.10 \pm .08 (28.0 \pm 2.0)	1.10 \pm .08 (28.0 \pm 2.0)	1.50 \pm .12 (38.0 \pm 3.0)	1.50 \pm .12 (38.0 \pm 3.0)
B – Body Length	.24 \pm .01 (6.0 \pm 0.3)	.35 \pm .02 (9.0 \pm 0.5)	.43 \pm .02 (11.0 \pm 0.5)	.59 \pm .02 (15.0 \pm 0.5)	.98 \pm .08 (25.0 \pm 2.0)
C – Lead Diameter	.024 \pm .002 (0.60 \pm 0.05)	.028 \pm .002 (0.70 \pm 0.05)	.031 \pm .002 (0.80 \pm 0.05)	.031 \pm .002 (0.80 \pm 0.05)	.031 \pm .002 (0.80 \pm 0.05)
D – Body Diameter	.09 \pm .01 (2.3 \pm 0.2)	.12 \pm .01 (3.0 \pm 0.3)	.16 \pm .02 (4.0 \pm 0.5)	.22 \pm .04 (5.5 \pm 1.0)	.34 \pm .06 (8.5 \pm 1.5)

ORDERING INFORMATION

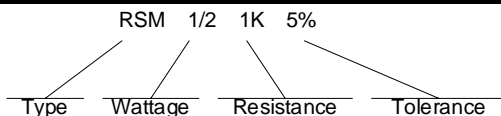

NOTES

1. SEI Type RSM is smaller than the industry standard.
2. E96 values for 1%, E24 values for 5%
3. $\pm 0.5\%$
4. After moisture resistance.
5. Available with swaged leads (see Section F).

High Resistance Metal Oxide Mini Resistors

SEI Type RLFS

- Extends Resistance Value of RS Series Above 100K (up to 1M)
- Temperature Coefficient of $\pm 200\text{ppm}/^\circ\text{C}$
- Coating Meets UL 94V-0

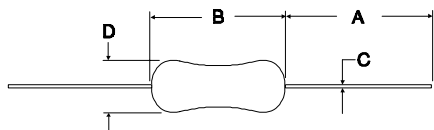

PERFORMANCE CHARACTERISTICS (TESTED PER EIAJ RC-2655)

ELECTRICAL	RLFS 1/2	RLFS 1	RLFS 2	RLFS 3	RLFS 5
Power Rating (Watts)	1/2 @ 70°C	1 @ 70°C	2 @ 70°C	3 @ 70°C	5 @ 70°C
Derated to 0 Load at	200°C	200°C	200°C	200°C	200°C
Maximum Working Voltage	350V	350V	350V	350V	500V
Operating Temperature Range	-55°C to +200°C	-55°C to +200°C	-55°C to +200°C	-55°C to +200°C	-55°C to +200°C
Resistance Range ¹	$\pm 1\%$ 47.5K – 200K $\pm 5\%$ 51K – 1M	76.8K – 200K 82K – 1M	102K – 200K 110K – 1M	121K – 200K 130K – 1M	154K – 200K 160K – 1M
Dielectric Withstand Voltage	350 volts RMS	350 volts RMS	600 volts RMS	700 volts RMS	800 volts RMS
Maximum Overload Voltage	600V	600V	700V	700V	1000V
Insulation Resistance	1,000 meg min.	1,000 meg min.	10,000 meg min.	10,000 meg min.	10,000 meg min.
ENVIRONMENTAL (Operating Temperature Range: -55°C to +200°C)					
Moisture Resistance	$\pm(5\%+0.05\Omega)$	$\pm(5\%+0.05\Omega)$	$\pm(5\%+0.05\Omega)$	$\pm(5\%+0.05\Omega)$	$\pm(5\%+0.05\Omega)$
Thermal Shock	$\pm(1\%+0.05\Omega)$	$\pm(1\%+0.05\Omega)$	$\pm(1\%+0.05\Omega)$	$\pm(1\%+0.05\Omega)$	$\pm(1\%+0.05\Omega)$
Load Life @ 70°C – 1,000 hrs	$\pm(5\%+0.05\Omega)$	$\pm(5\%+0.05\Omega)$	$\pm(5\%+0.05\Omega)$	$\pm(5\%+0.05\Omega)$	$\pm(5\%+0.05\Omega)$
Shock and Vibration	$\pm(1\%+0.05\Omega)$	$\pm(1\%+0.05\Omega)$	$\pm(1\%+0.05\Omega)$	$\pm(1\%+0.05\Omega)$	$\pm(1\%+0.05\Omega)$
Resistance to Soldering Heat	$\pm(1\%+0.05\Omega)$	$\pm(1\%+0.05\Omega)$	$\pm(1\%+0.05\Omega)$	$\pm(1\%+0.05\Omega)$	$\pm(1\%+0.05\Omega)$
Short Time Overload	$\pm 1\%$	$\pm 1\%$	$\pm 1\%$	$\pm 1\%$	$\pm 1\%$

DERATING CURVE

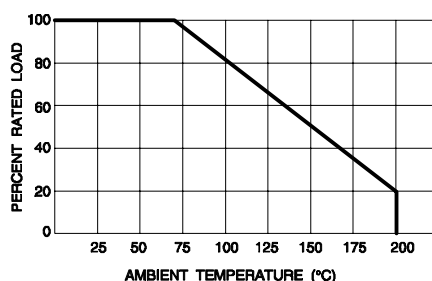

DIMENSIONS: Inches (mm)

FEATURE	RLFS 1/2	RLFS 1	RLFS 2	RLFS 3	RLFS 5
A – Lead Length (typ.)	1.18 ±.12 (30.0 ±3.0)	1.18 ±.12 (30.0 ±3.0)	1.18 ±.12 (30.0 ±3.0)	1.50 ±.12 (38.0 ±3.0)	1.50 ±.12 (38.0 ±3.0)
B – Body Length	.25 ±.02 (6.3 ±0.5)	.35 ±.04 (9.0 ±1.0)	.43 ±.04 (11.0 ±1.0)	.59 ±.04 (15.0 ±1.0)	.96 ±.04 (24.5 ±1.0)
C – Lead Diameter	.024 ±.002 (0.60 ±0.05)	.024 ±.002 (0.60 ±0.05)	.031 ±.002 (0.80 ±0.05)	.031 ±.002 (0.80 ±0.05)	.031 ±.002 (0.80 ±0.05)
D – Body Diameter	.09 ±.02 (2.3 ±0.5)	.14 ±.02 (3.5 ±0.5)	.16 ±.02 (4.0 ±0.5)	.24 ±.04 (6.0 ±1.0)	.35 ±.04 (9.0 ±1.0)

ORDERING INFORMATION

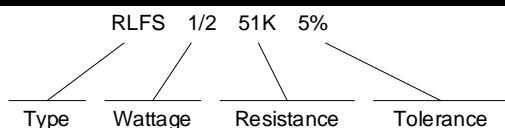

NOTES

1. E96 values for 1%, E24 values for 5%.
2. Tape and reel packaging per RS-296.

www.DataSheet4U.com

Metal Oxide Resistors

Performance Curves

PERFORMANCE CURVES

Power - Temperature Derating

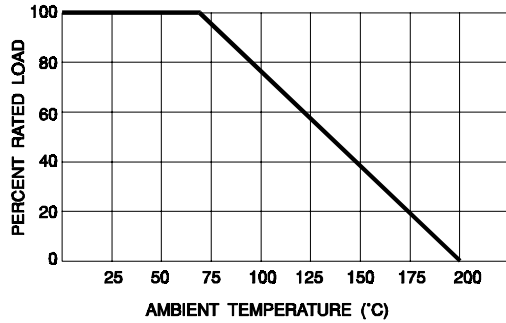

Current Noise

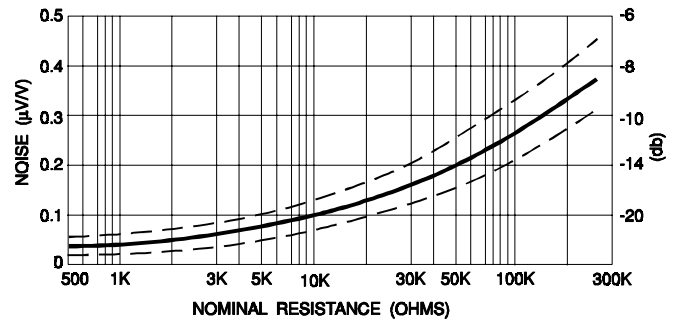

Surface Temperature Rise vs. Load - Type RS

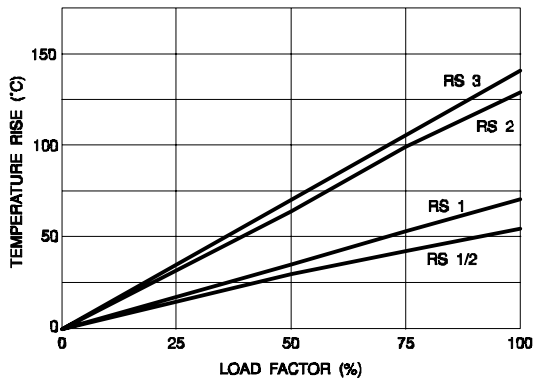

Surface Temperature Rise vs. Load - Type RSM

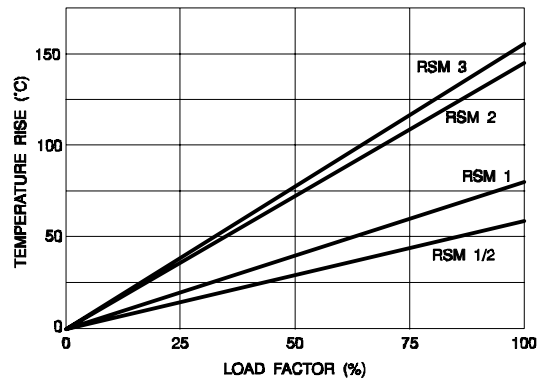

Low Resistance Metal-Alloy Mini Resistors

SEI Type RMF

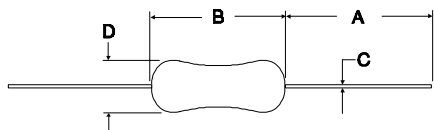

- Very Low Resistance Values
- Reduced Size
- Temperature Coefficient of $\pm 350\text{ppm}/^\circ\text{C}$
- Coating Meets UL 94V-0

PERFORMANCE CHARACTERISTICS

ELECTRICAL	RMF 1/2	RMF 1	RMF 2	RMF 3	RMF 5
Power Rating (Watts)	1/2 @ 70°C	1 @ 70°C	2 @ 70°C	3 @ 70°C	5 @ 70°C
Derated to 0 Load at	200°C	200°C	200°C	200°C	200°C
Maximum Working Voltage	350V	350V	350V	350V	500V
Operating Temperature Range	-55°C to +200°C	-55°C to +200°C	-55°C to +200°C	-55°C to +200°C	-55°C to +200°C
Resistance Range ¹	0.01 – 0.091Ω	0.01 – 0.091Ω	0.01 – 0.091Ω	0.01 – 0.091Ω	0.01 – 0.091Ω
Tolerance	±5% & ±10%	±5% & ±10%	±5% & ±10%	±5% & ±10%	±5% & ±10%
Dielectric Withstand Voltage	350V	350V	600V	700V	800V
Insulation Resistance, Dry	1,000 meg min.	1,000 meg min.	1,000 meg min.	1,000 meg min.	1,000 meg min.
ENVIRONMENTAL (Operating Temperature Range: -55°C to +200°C)					
Moisture Resistance	±5%	±5%	±5%	±5%	±5%
Thermal Shock	±2%	±2%	±2%	±2%	±2%
Load Life @ 70°C – 1,000 hrs	±5%	±5%	±5%	±5%	±5%
Shock and Vibration	±1%	±1%	±1%	±1%	±1%
Resistance to Soldering Heat	±0.5%	±0.5%	±0.5%	±0.5%	±0.5%
Terminal Strength	±0.5%	±0.5%	±0.5%	±0.5%	±0.5%
Short Time Overload	±2%	±2%	±2%	±2%	±2%

DERATING CURVE

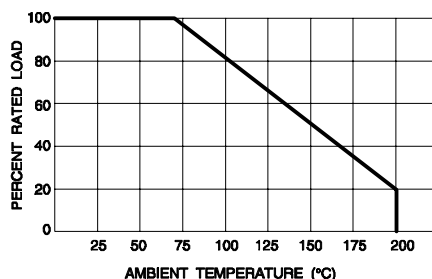

DIMENSIONS: Inches (mm)

FEATURE	RMF 1/2	RMF 1	RMF 2	RMF 3	RMF 5
A – Lead Length (typ.)	1.18 ±.12 (30.0 ±3.0)	1.18 ±.12 (30.0 ±3.0)	1.18 ±.12 (30.0 ±3.0)	1.50 ±.12 (38.0 ±3.0)	1.50 ±.12 (38.0 ±3.0)
B – Body Length	.25 ±.02 (6.3 ±0.5)	.35 ±.02 (9.0 ±0.5)	.43 ±.04 (11.0 ±1.0)	.59 ±.04 (15.0 ±1.0)	.96 ±.04 (24.5 ±1.0)
C – Lead Diameter	.024±.002 (0.60±0.05)	.024±.002 (0.60±0.05)	.031±.002 (0.80±0.05)	.031±.002 (0.80±0.05)	.031±.002(0.80±0.05)
D – Body Diameter	.09 ±.02 (2.3 ±0.5)	.12 ±.01 (3.0 ±0.3)	.16 ±.02 (4.0 ±0.5)	.24 ±.04 (6.0 ±1.0)	.35 ±.04 (9 ±1.0)

ORDERING INFORMATION



NOTES

1. E24 values for 5%, E12 values for 10%.
2. Tape and reel packaging per RS-296.

www.DataSheet4U.com

High Resistance Metal (Glaze) Resistors

SEI Type RMG

- High Resistance Values
- Tight Tolerance
- Temperature Coefficient of $\pm 100\text{ppm}/^\circ\text{C}$
- Excellent Pulse Voltage Capability

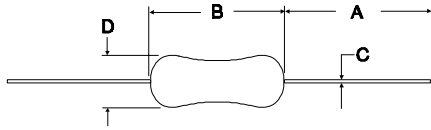

PERFORMANCE CHARACTERISTICS (TESTED PER MIL-R-22684 Rev. C)					
ELECTRICAL	RMG 1/6	RMG 1/4	RMG 1/2	RMG 1	RMG 2
Power Rating (Watts)	1/6 @ 70°C	1/4 @ 70°C	1/2 @ 70°C	1 @ 70°C	2 @ 70°C
Derated to 0 Load at	125°C	125°C	125°C	125°C	125°C
Maximum Working Voltage	300V	500V	1000V	2000V	3000V
Operating Temperature Range	-30°C to +125°C	-30°C to +125°C	-30°C to +125°C	-30°C to +125°C	-30°C to +125°C
Resistance Range ¹	100K – 500M	100K – 1,000M	100K – 10,000M	100K – 10,000M	100K – 10,000M
Tolerance ^{2,5}	$\pm 1\%$ & $\pm 5\%$	$\pm 1\%$ & $\pm 5\%$	$\pm 1\%$ & $\pm 5\%$	$\pm 1\%$ & $\pm 5\%$	$\pm 1\%$ & $\pm 5\%$
Maximum Pulse Voltage ³	1,000V	1,250V	2,500V	5,000V	7,500V
Insulation Resistance, Dry	10,000 meg min.	10,000 meg min.	10,000 meg min.	10,000 meg min.	10,000 meg min.
ENVIRONMENTAL (Operating Temperature Range: -30°C to +125°C)					
Moisture Resistance	$\pm 5\%$	$\pm 5\%$	$\pm 5\%$	$\pm 5\%$	$\pm 5\%$
Thermal Shock	$\pm 3\%$	$\pm 3\%$	$\pm 3\%$	$\pm 3\%$	$\pm 3\%$
Load Life @ 70°C – 1,000 hrs	$\pm 5\%$	$\pm 5\%$	$\pm 5\%$	$\pm 5\%$	$\pm 5\%$
Resistance to Soldering Heat	$\pm 2\%$	$\pm 2\%$	$\pm 2\%$	$\pm 2\%$	$\pm 2\%$
Short Time Overload	$\pm 2\%$	$\pm 2\%$	$\pm 2\%$	$\pm 2\%$	$\pm 2\%$

DERATING CURVE

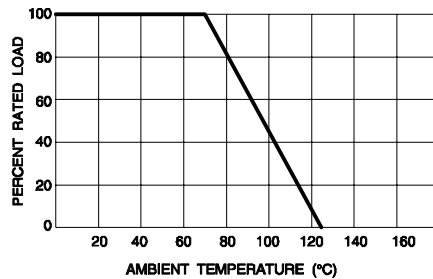

FEATURE	DIMENSIONS: Inches (mm)				
	RMG 1/6	RMG 1/4	RMG 1/2	RMG 1	RMG 2
A – Lead Length (typ.)	1.18 ±.12 (30.0 ±3.0)	1.18 ±.12 (30.0 ±3.0)	1.18 ±.12 (30.0 ±3.0)	1.18 ±.12 (30.0 ±3.0)	1.50 ±.12 (38.0 ±3.0)
B – Body Length	.13 ±.01 (3.3 ±0.2)	.25 ±.02 (6.3 ±0.5)	.35 ±.02 (9.0 ±0.5)	.43 ±.04 (11.0 ±1.0)	.59 ±.04 (15.0 ±1.0)
C – Lead Diameter	.020±.002 (0.50±0.05)	.024±.002 (0.60±0.05)	.024±.002 (0.60±0.05)	.031±.002 (0.80±0.05)	.031±.002(0.80±0.05)
D – Body Diameter	.07 ±.01 (1.7 ±0.2)	.09 ±.02 (2.3 ±0.5)	.14 ±.02 (3.5 ±0.5)	.16 ±.02 (4.0 ±0.5)	.24 ±.04 (6 ±1.0)

ORDERING INFORMATION

RMG 1/2 10M 5%

Type Wattage Resistance Tolerance

NOTES

1. E96 values for 1%, E24 values for 5%.
2. Tighter tolerance & T.C. available – contact factory.
3. Pulse voltage is under standard waveform of 1x40μs.
4. Tape and reel packaging per RS-296.
5. $\pm 1\%$ tolerance to 100 Meg max.

Pulse Metal (Glaze) Resistors

SEI Type CRMG

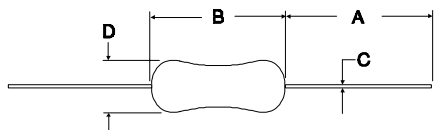

- High Resistance With Stability
- Withstands High Voltage
- E24 Standard Values Available
- Temperature Coefficient of $\pm 100\text{ppm}/^\circ\text{C}$

PERFORMANCE CHARACTERISTICS

ELECTRICAL		CRMG 1/2
Power Rating (Watts) Derated to 0 Load at Maximum Working Voltage		1/2 @ 70°C 125°C 1000V
Operating Temperature Range Resistance Range ^{1,2} Tolerance		-30°C to +125°C 0.33Ω – 33M ±5%
Maximum Overload Voltage Maximum Pulse Voltage Insulation Resistance, Dry		2,000V 3,000V 10,000 meg min.
ENVIRONMENTAL (Operating Temperature Range: -30°C to +125°C)		
Moisture Resistance Thermal Shock Load Life @ 70°C – 1,000 hrs		±5% ±3% ±5%
Resistance to Soldering Heat Short Time Overload		±2% ±2%

PULSE CHARACTERISTICS

Applied Voltage (AC)	5KV
Pulse Test	1 sec ON 1 sec OFF 5 cycles
Resistance Change	±5% Max.

DERATING CURVE

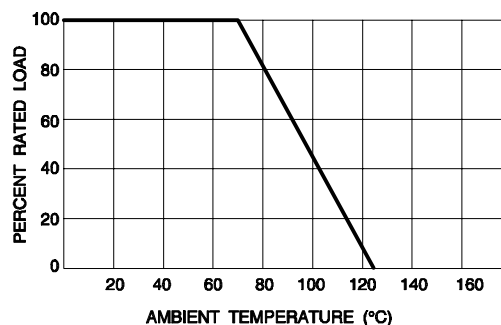

DIMENSIONS:

FEATURE	Inches (mm)
	CRMG 1/2
A – Lead Length (typ.)	1.18 ±.12 (30.0 ±3.0)
B – Body Length	.35 ±.02 (9.0 ±0.5)
C – Lead Diameter	.024±.002 (0.60±0.05)
D – Body Diameter	.14 ±.02 (3.5 ±0.5)

ORDERING INFORMATION

CRMG	1/2	1M	5%
Type	Wattage	Resistance	Tolerance

NOTES

1. 1M–10M UL Recognized (UL 1676, File No. E159237) and CSA C22.2 No. 1-M90.
2. Tape and reel packaging per RS-296.

www.DataSheet4U.com

Jumper Wire

SEI Type JW

- Ideally Suited for “Crossovers” or “Jumpers” on PCBs with Auto Insertion Capability

SPECIFICATIONS				
TYPE	JW50	JW55	JW60	JW80
Diameter - Inches (mm)	.020 ±.001 (0.50 ±0.02)	.022 ±.001 (0.55 ±0.03)	.024 ±.001 (0.60 ±0.03)	.031 ±.002 (0.80 ±0.05)
Gauge Reference	24	23	22	20
Max. Current	2 Amp.	3 Amp.	3 Amp.	4 Amp.

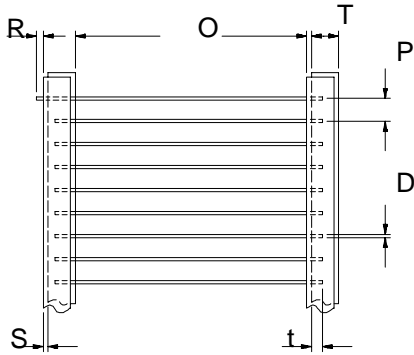

DIMENSIONS:		Inches (mm)					
O	P	T	R	D	t	S	
2.047 ±.039 (52.00 ±1.00)	.200 ±.016 (5.00 ±0.40)	.236 ±.039 (6.00 ±1.00)	0	See TYPE above	.118 min. (3.00) min.	.020 max. (0.50) max.	

NOTES
1. JW50 & JW55 in 10,000 piece Ammo Box or Lead Tape Reel.
2. JW60 available in 10,000 piece Lead Tape Reel only.
2. JW80 available in 8,000 piece Lead Tape Reel or Ammo Box.
3. Contact factory for JW55 in 20,000 piece Lead Tape Reels.

Zero-Ohm Resistors

SEI Type CD

- “Crossover” or “Jumper” Applications

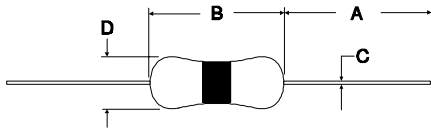

SPECIFICATIONS		
TYPE	CD 1/8Z	CD 1/4Z
Size	1/8W	1/4W
Resistance	0.01Ω or less	0.01Ω or less
Dielectric Withstand Voltage	300V RMS min.	500V RMS min.
Operating Temperature	-55°C to +155°C	-55°C to +155°C
Marking	Single Black Band	Single Black Band
Current Rating	2A @ 70°C	3A @ 70°C

DIMENSIONS:		Inches (mm)	
FEATURE	CD 1/8Z	CD 1/4Z	
A – Lead Length (typ.)	1.10 ±.08 (28.0 ±2.0)	1.10 ±.08 (28.0 ±2.0)	
B – Body Length	.12 +.01/-0.00 (3.2 +0.2/-0.0)	.24 ±.01 (6.0 ±0.3)	
C – Lead Diameter	.018 ±.001 (0.45 ±0.02)	.022 ±.001 (0.55 ±0.03)	
D – Body Diameter	.07 ±.01 (1.8 ±0.2)	.09 ±.01 (2.3 ±0.2)	

www.DataSheet4U.com

SEI Electronics Inc. • P.O. Box 58789 • Raleigh, NC 27658-8789 • Telephone: (919) 850-9500 • FAX: (919) 850-9504
Toll Free: (888) SEI-SEI-SEI • www.seielect.com • email: marketing@seielect.com • ISO 9002 Registered

Carbon Film Resistors

SEI Type CF

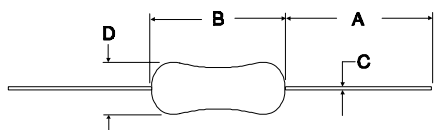

- General Purpose Type
- Meets Requirements of MIL-R-22684
- Ideal for Commercial/Industrial Applications
- Auto Sequencing/Insertion Compatible
- Flame Retardant Coatings Standard, Flame Proof⁴ Optional
- Pana-Sert Available (1/4W) – See F-2 for Specifications

PERFORMANCE CHARACTERISTICS (TESTED PER MIL-STD-202)

ELECTRICAL	CF 1/8	CF 1/4	CF 1/2
Power Rating (Watts)	1/8 @70°C	1/4 @70°C	1/2 @70°C
Derated to 0 Load at	155°C	155°C	155°C
Maximum Working Voltage	200V	250V	350V
Operating Temperature Range	-55°C to +155°C	-55°C to +155°C	-55°C to +155°C
Resistance Range (±5%)	1.0Ω – 22M	1.0Ω – 22M	1.0Ω – 22M
(±2%)	10Ω – 1M	10Ω – 4.7M	10Ω – 4.7M
Dielectric Withstand Voltage	300 volts RMS min.	500 volts RMS min.	700 volts RMS min.
Maximum Pulse Voltage	400V	600V	700V
Insulation Resistance	10,000 meg min.	10,000 meg min.	10,000 meg min.
ENVIRONMENTAL			
Moisture Resistance	<100K ±(3%+0.05Ω) ≥100K ±(5%+0.05Ω)	<100K ±(3%+0.05Ω) ≥100K ±(5%+0.05Ω)	<100K ±(3%+0.05Ω) ≥100K ±(5%+0.05Ω)
Thermal Shock	±0.5%	±0.5%	±0.5%
Load Life @ 70°C — 1,000 hrs	<100K ±(2%+0.05Ω) ≥100K ±(3%+0.05Ω)	<100K ±(2%+0.05Ω) ≥100K ±(3%+0.05Ω)	<100K ±(2%+0.05Ω) ≥100K ±(3%+0.05Ω)
Shock and Vibration	±0.2%	±0.2%	±0.2%
Resistance to Soldering Heat	±0.5%	±0.5%	±0.5%
Terminal Strength	±0.5%	±0.5%	±0.5%
Voltage Coefficient	-10 ppm/V max.	-10 ppm/V max.	-10 ppm/V max.
Short Time Overload	±(0.75%+0.05Ω)	±(0.75%+0.05Ω)	±(0.75%+0.05Ω)

DIMENSIONS: Inches (mm)

FEATURE	CF 1/8	CF 1/4	CF 1/2
A – Lead Length (typ.)	1.10 ±.08 (28.0 ±2.0)	1.10 ±.08 (28.0 ±2.0)	1.10 ±.08 (28.0 ±2.0)
B – Body Length	.13 +.01/-0 (3.2 +0.2/-0)	.24 ±.01 (6.0 ±0.3)	.33 ±.02 (8.5 ±0.5)
C – Lead Diameter	.018 ±.001 (0.45 ±0.02)	.022 ±.001 (0.55 ±0.03)	.026 ±.002 (0.65 ±0.05)
D – Body Diameter	.07 ±.01 (1.8 ±0.15)	.09 ±.01 (2.3 ±0.2)	.11 ±.01 (2.8 ±0.3)

ORDERING INFORMATION

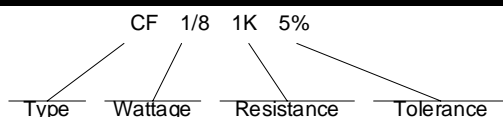

NOTES

1. 1/4W available in Panasert (10Ω – 1 meg range standard).
2. Cut and formed leads available (see Section F).
3. Tan body color introduced in 3rd quarter 1995.
4. Add "F" suffix to Type. Example "CFF"

Carbon Film Mini Series Resistors

SEI Type CFM

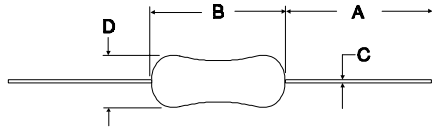

- Ideal Substitute Where Size Restrictions Apply¹
- General Purpose Type
- Ideal for Commercial/Industrial Applications
- Auto Sequencing/Insertion Compatible
- Flame Retardant Coatings Standard, Flame Proof Optional
- Light Brown Body Color
- Pana-Sert Available (1/2W) – See F-2 for Specifications

PERFORMANCE CHARACTERISTICS (TESTED PER MIL-STD-202)

ELECTRICAL	CFM 1/4	CFM 1/2
Power Rating (Watts)	1/4 @70°C	1/2 @70°C
Derated to 0 Load at	155°C	155°C
Maximum Working Voltage	250V	350V
Operating Temperature Range	-55°C to +155°C	-55°C to +150°C
Resistance Range (±5%) ³	1Ω – 22M	1Ω – 22M
Dielectric Withstand Voltage	500 volts RMS min.	500 volts RMS min.
Maximum Pulse Voltage	600V	700V
Insulation Resistance	10,000 meg min.	10,000 meg min.
ENVIRONMENTAL		
Moisture Resistance	<100K ±(3%+0.05Ω) ≥100K ±(5%+0.05Ω)	<100K ±(3%+0.05Ω) ≥100K ±(5%+0.05Ω)
Thermal Shock	±0.5%	±0.5%
Load Life @ 70°C — 1,000 hrs	<100K ±(2%+0.05Ω) ≥100K ±(3%+0.05Ω)	<100K ±(2%+0.05Ω) ≥100K ±(3%+0.05Ω)
Shock and Vibration	±0.2%	±0.2%
Resistance to Soldering Heat	±0.5%	±0.5%
Terminal Strength	±0.5%	±0.5%
Voltage Coefficient	-10 ppm/V min.	-10 ppm/V min.
Short Time Overload	±(0.75%+0.05Ω)	±(0.75%+0.05Ω)

DIMENSIONS: Inches (mm)

FEATURE	CFM 1/4	CFM 1/2
A – Lead Length (typ.)	1.10 ±.08 (28.0 ±2.0)	1.10 ±.08 (28.0 ±2.0)
B – Body Length	.13 ±.01/-0 (3.2 ±0.2/-0)	.24 ±.01 (6.0 ±0.3)
C – Lead Diameter	.018 ±.001 (0.45 ±0.02)	.022 ±.001 (0.55 ±0.03)
D – Body Diameter	.07 ±.01 (1.9 ±0.1)	.09 ±.01 (2.3 ±0.2)

ORDERING INFORMATION

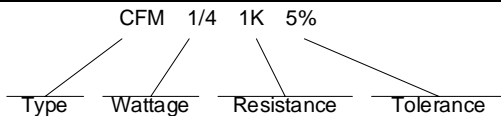

NOTES

1. 1/2W rating in 1/4W package size and 1/4W rating in 1/8W size.
2. Cut and formed leads available (see Section F).
3. ±2% tolerance available (10Ω - 1meg).

Carbon Film Resistors

Performance Curves/Construction

PERFORMANCE CURVES

Temperature Coefficient (Typical)

Note: Typical T/C for 11-22M is -2,800 ppm/°C.

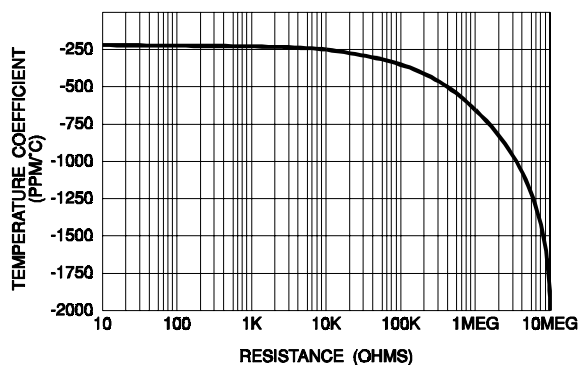

Derating Curve (Typical)

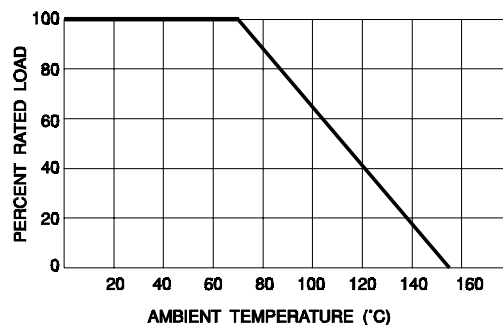

Current Noise (Typical)

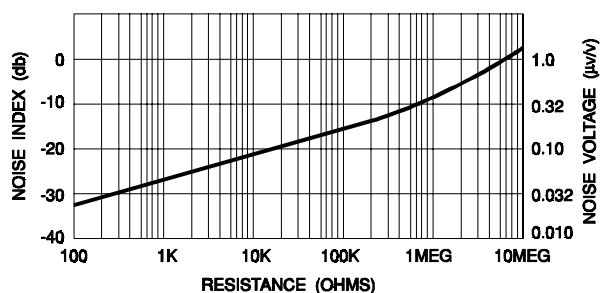

Surface Temperature Rise vs. Load

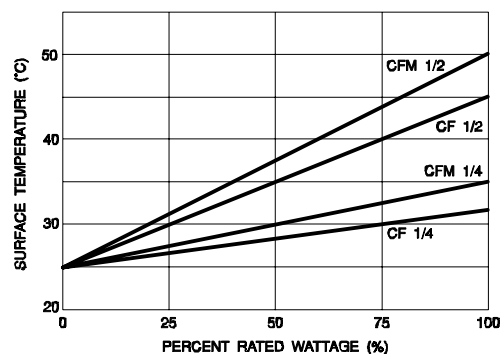

CONSTRUCTION

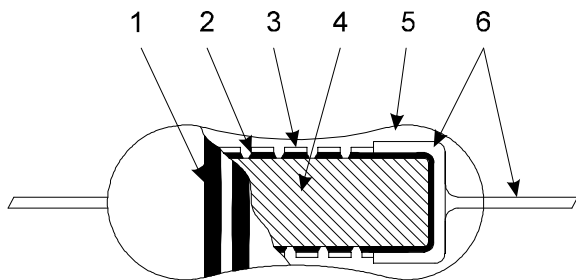

- COLOR BANDS.** The resistors are permanently color banded for resistance value and tolerance in accordance with EIA specifications.
- HELIXING.** The units are helixed to a predetermined base to final value ratio to obtain the best TCR, noise and stability characteristics.
- FILM.** Carbon-film resistors have a homogeneous film of pure carbon deposited by a pyrolytic process at carefully controlled temperatures.
- SUBSTRATES.** The substrates are of a proprietary nonalkaline ceramic,

prepared and processed under exacting conditions to guarantee the utmost in uniformity and surface characteristics.

- INSULATION.** The resistors are coated with multiple layers of a baked-on fire-retardant synthetic resin which provides the units with a high degree of mechanical and electrical protection in the most adverse operating conditions.
- TERMINATIONS.** Positive contact is provided to the resistant element by precision-made end caps. The lead wires are attached by using proprietary welding techniques.

www.DataSheet4U.com

Carbon Film Resistors

Performance Curves/Notes

PERFORMANCE CURVES

Surface Temperature Rise vs. Load - Type CF

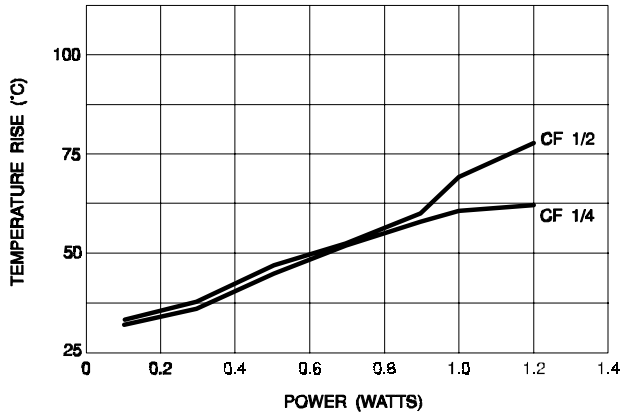

Surface Temperature Rise vs. Load - Type CFM

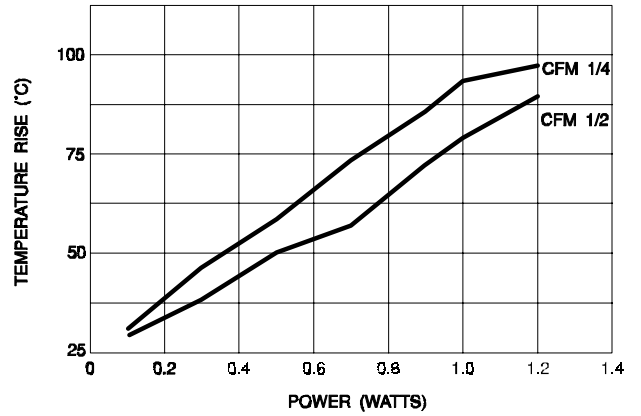

NOTES

Carbon Composition Resistors

SEI Type RC

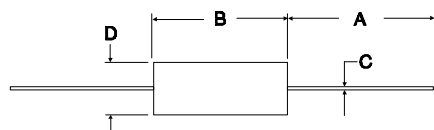

- Non-Inductive Design
- Meets Performance Standards of EIA RS-172
- Hot Molded Process for Product Uniformity
- Ideal for Pulse-Load Handling
- Brown Body Color

PERFORMANCE CHARACTERISTICS (TESTED PER MIL-STD-202)

ELECTRICAL	RC 1/4	RC 1/2
Power Rating (Watts) Derated to 0 Load at Rated Continuous Working Voltage (RCWW)	1/4 @70°C 130°C $\sqrt{P_x R}$ or 250V whichever is less	1/2 @70°C 130°C $\sqrt{P_x R}$ or 350V whichever is less
Dielectric Withstand Voltage	500V (325V @ 3.4"Hg)	700V (450V @ 3.4"Hg)
Resistance Range	1.0Ω – 5.6 meg	1.0Ω – 20 meg ¹
Tolerance	±5% and ±10%	±5% and ±10%
Maximum Pulse Voltage	400 volts RMS	700 volts RMS
Insulation Resistance	10,000 meg min.	10,000 meg min.
ENVIRONMENTAL		
Moisture Resistance	±5% typ. (1% to 7% max.)	±4% typ. (1% to 6% max.)
Thermal Shock	±1% typ. (±2% max.)	±1% typ. (±2% max.)
Load Life @ 70°C — 1,000 hrs	-3% typ. (2% to -5% max.)	-3% typ. (2% to -5% max.)
Vibration (High-Frequency)	±1% max.	±1% max.
Shock (Specified Pulse)	±2% max.	±2% max.
Resistance to Soldering Heat	-0.5% to +2% typ. (±3% max.)	-0.5% to +2% typ. (±3% max.)
Terminal Strength	±1% max.	±1% max.
Low-Temperature Operation	±0.5% typ. (±2% max.)	±0.5% typ. (±2% max.)
Voltage Coefficient (1K - 20 meg)	-0.005%/V to -0.032%/V	-0.005%/V to -0.032%/V
Short Time Overload	±0.5% typ. (±2% max.)	±0.5% typ. (±2% max.)

RESISTANCE TEMPERATURE CHARACTERISTICS

	Resistance Range	-55°C	+105°C
Maximum % resistance change from room temperature (+25°C) value.	under 1K	+2.0 to +5.0	-4.0 to -2.0
	1K to 9.1K	+5.0 to +9.0	-5.0 to -3.0
	10K to 91K	+8.0 to +11.0	-7.0 to -5.0
	100K to 910K	+10.0 to +14.0	-9.0 to -7.0
	1 meg to 10 meg	+13.0 to +20.0	-14.0 to -9.0

DIMENSIONS: Inches (mm)

FEATURE	RC 1/4	RC 1/2
A – Lead Length (typ.)	1.102 ±.032 (28.0 ±0.80)	1.024 ±.032 (26.0 ±0.80)
B – Body Length	.248 ±.028 (6.30 ±0.70)	.374 +.032/-.028 (9.50 +0.80/-0.70)
C – Lead Diameter	.024 ±.002 (0.60 ±0.05)	.027 ±.002 (0.7 ±0.05)
D – Body Diameter	.094 ±.004 (2.40 ±0.10)	.142 ±.008 (3.60 ±0.20)

ORDERING INFORMATION

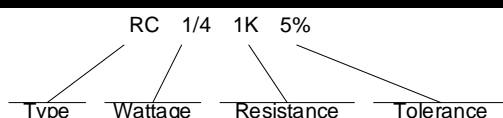

NOTES

1. Special 1Ω ±5% resistor available in 1/2W only. Contact factory.
2. Cut and formed leads available (see Section F).

www.DataSheet4U.com

SEI Electronics Inc. • P.O. Box 58789 • Raleigh, NC 27658-8789 • Telephone: (919) 850-9500 • FAX: (919) 850-9504
Toll Free: (888) SEI-SEI-SEI • www.seielect.com • email: marketing@seielect.com • ISO 9002 Registered

Carbon Composition Resistors

SEI Type RC

PERFORMANCE CURVES

Surge Resistance Characteristics (RC 1/4)

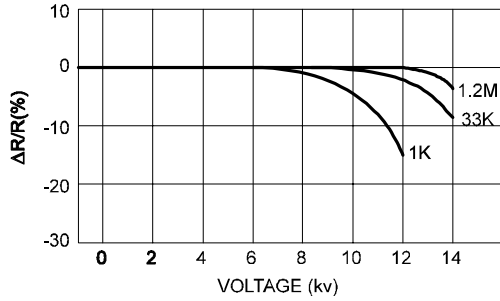

Surge Resistance Characteristics (RC 1/2)

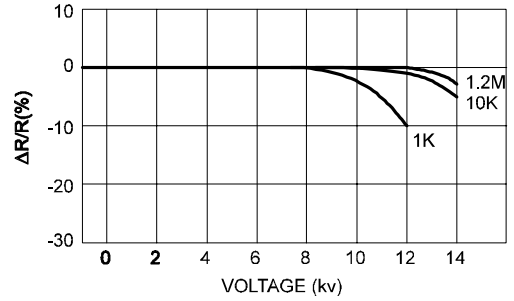

Load Ratio vs. Temperature

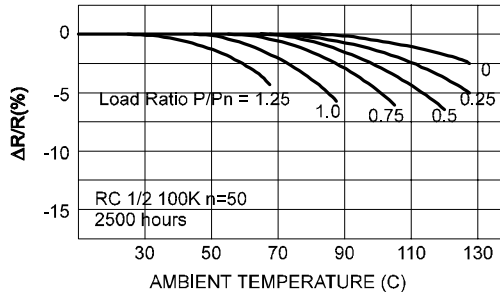

Load Life (Rated Load)

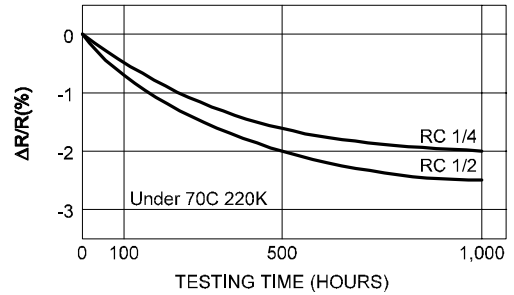

Variation With Time

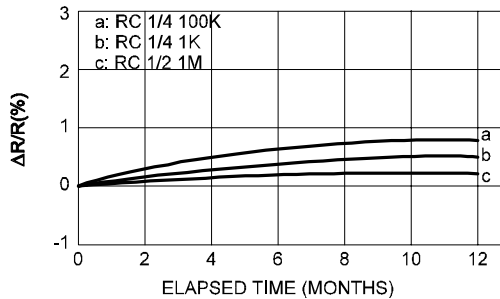

Frequency Characteristics

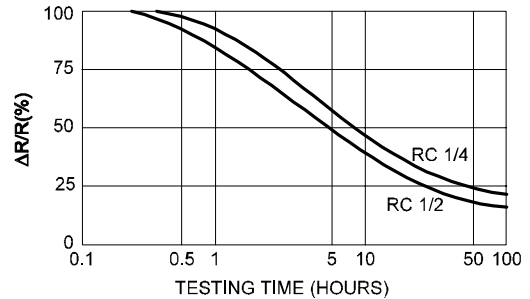

RELIABILITY TEST – Load Life in Moisture

Criterion (%)	Load Ratio P/Pn (%)	Total Testing Time (Hrs)	Number of Fractures(pcs)	Failure Ratio		Average Lifetime (60% reliability level) (Hrs)
				λ	$\lambda_{CL} (60\%)$	
$\Delta R/R$	± 5	0	6	0.201	0.244	4.098×10^5
		20	4	0.134	0.176	5.682×10^5
		60	2	0.067	0.104	9.615×10^5
		100	3	0.100	0.139	7.194×10^5
		Total	15	0.125	0.138	7.209×10^5
	± 10	Total	0	0.0055	0.0077	1.299×10^7

www.DataSheet4U.com

Wirewound Resistors

SEI Type WRF

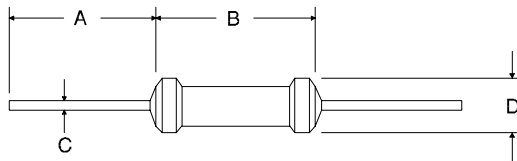

- Conformal Coated
- Flame Proof
- Temperature Coefficient of $\pm 100\text{ppm}/^\circ\text{C}$

PERFORMANCE CHARACTERISTICS

ELECTRICAL	WRF 1	WRF 2	WRF 3
Power Rating (Watts) Derated to 0 Load at Maximum Working Voltage	1 @ 85°C 250°C $\sqrt{\text{PR}}$	2 @ 85°C 250°C $\sqrt{\text{PR}}$	3 @ 85°C 250°C $\sqrt{\text{PR}}$
Operating Temperature Range	-55°C to +250°C	-55°C to +250°C	-55°C to +250°C
Resistance Range	0.1Ω – 180Ω ²	0.1Ω – 1.2K ²	0.1Ω – 1.2K ²
Tolerance	±5%	±5%	±5%
Dielectric Withstand Voltage	700 volts RMS	700 volts RMS	700 volts RMS
Insulation Resistance	100 meg min.	100 meg min.	100 meg min.
ENVIRONMENTAL (Operating Temperature Range: -55°C to +250°C)			
Moisture Resistance	±(5%+0.05Ω)	±(5%+0.05Ω)	±(5%+0.05Ω)
Thermal Shock	±(2%+0.05Ω)	±(2%+0.05Ω)	±(2%+0.05Ω)
Load Life @ 70°C – 1,000 hrs	±(5%+0.05Ω)	±(5%+0.05Ω)	±(5%+0.05Ω)
Shock and Vibration	±(1%+0.05Ω)	±(1%+0.05Ω)	±(1%+0.05Ω)
Resistance to Soldering Heat	±(2%+0.05Ω)	±(2%+0.05Ω)	±(2%+0.05Ω)
Short Time Overload	±(3%+0.05Ω)	±(3%+0.05Ω)	±(3%+0.05Ω)

DERATING CURVE

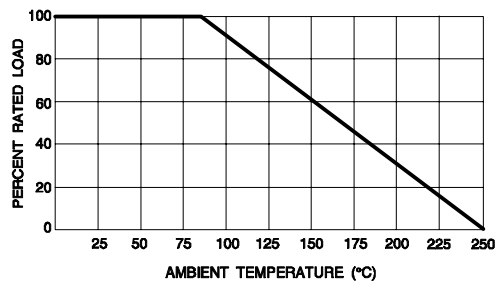

SURFACE TEMPERATURE RISE

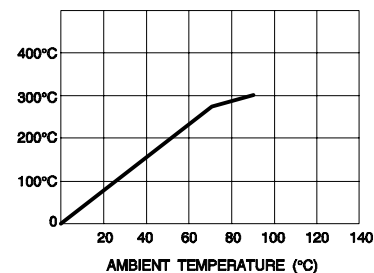

DIMENSIONS: Inches (mm)

FEATURE	WRF 1	WRF 2	WRF 3
A – Lead Length (typ.)	1.10 ±.08 (28.0 ±2.0)	1.10 ±.08 (28.0 ±2.0)	1.10 ±.08 (28.0 ±2.0)
B – Body Length	.39 max. (9.9 max.)	.55 max. (14.0 max.)	.59 max. (15.0 max.)
C – Lead Diameter	.026±.002 (0.65±0.05)	.031±.002 (0.80±0.05)	.031±.002 (0.80±0.05)
D – Body Diameter	.14 ±.02 (3.5 ±0.5)	.18 ±.02 (4.5 ±0.5)	.18 ±.02 (4.5 ±0.5)

ORDERING INFORMATION

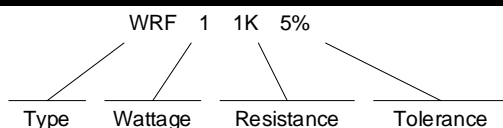

NOTES

1. Tape and reel packaging per RS-296.
2. Contact factory for higher ohmic value consideration.

www.DataSheet4U.com

Wirewound Ceramic Resistors

SEI Type NSP1

- Flame Proof Construction
- Temperature Coefficient of $\pm 200\text{ppm}/^\circ\text{C}$
- Low Resistance Values

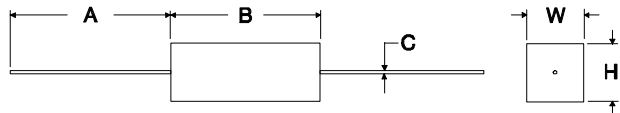

PERFORMANCE CHARACTERISTICS

ELECTRICAL	NSP1-2	NSP1-3	NSP1-5	NSP1-7	NSP1-10	NSP1-15	NSP1-20
Power Rating (Watts)	2 @ 25°C	3 @ 25°C	5 @ 25°C	7 @ 25°C	10 @ 25°C	15 @ 25°C	20 @ 25°C
Derated to 0 Load at	250°C	250°C	250°C	250°C	250°C	250°C	250°C
Maximum Working Voltage	100V	200V	300V	350V	500V	600V	700V
Operating Temperature Range	-55 to +250°C	-55 to +200°C	-55 to +200°C	-55 to +200°C	-55 to +200°C	-55 to +200°C	-55 to +200°C
Resistance Range	0.1Ω – 680Ω	0.1Ω – 510Ω	0.1Ω – 510Ω	0.1Ω – 1.5K	0.1Ω – 2K	0.15Ω – 2K	0.2Ω – 2K
Tolerance	±5%	±5%	±5%	±5%	±5%	±5%	±5%
Insulation Resistance	100 meg min.	100 meg min.	100 meg min.	100 meg min.	100 meg min.	100 meg min.	100 meg min.
ENVIRONMENTAL (Operating Temperature Range: -55°C to +250°C)							
Moisture Resistance	±5%	±5%	±5%	±5%	±5%	±5%	±5%
Thermal Shock	±2%	±2%	±2%	±2%	±2%	±2%	±2%
Load Life @ 70°C – 1,000 hrs	±5%	±5%	±5%	±5%	±5%	±5%	±5%
Resistance to Soldering Heat	±2%	±2%	±2%	±2%	±2%	±2%	±2%
Short Time Overload	±2%	±2%	±2%	±2%	±2%	±2%	±2%
Dielectric Withstand Voltage	±2%	±2%	±2%	±2%	±2%	±2%	±2%

DERATING CURVE

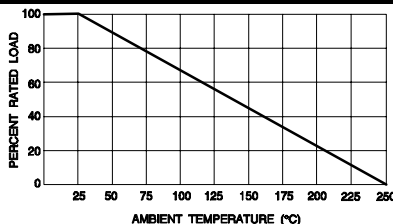

DIMENSIONS: Inches (mm)

FEATURE	NSP1-2	NSP1-3	NSP1-5	NSP1-7	NSP1-10	NSP1-15	NSP1-20
A – Lead Length	1.38 ±.12 (35.0 ±3.0)	1.38 ±.12 (35.0 ±3.0)	1.38 ±.12 (35.0 ±3.0)	1.38 ±.12 (35.0 ±3.0)	1.38 ±.12 (35.0 ±3.0)	1.38 ±.12 (35.0 ±3.0)	1.38 ±.12 (35.0 ±3.0)
B – Body Length	.71 ±.02 (18.0 ±0.5)	.87 ±.02 (22.0 ±0.5)	.87 ±.02 (22.0 ±0.5)	1.38 ±.02 (35.0 ±0.5)	1.89 ±.02 (48.0 ±0.5)	1.89 ±.02 (48.0 ±0.5)	2.56 ±.02 (65.0 ±0.5)
C – Lead Diameter	.026 ±.002 (0.65 ±0.05)	.032 ±.002 (0.80 ±0.05)	.032 ±.002 (0.80 ±0.05)	.032 ±.002 (0.80 ±0.05)	.032 ±.002 (0.80 ±0.05)	.032 ±.002 (0.80 ±0.05)	.032 ±.002 (0.80 ±0.05)
H – Body Height	.28 ±.02 (7.0 ±0.5)	.32 ±.02 (8.0 ±0.5)	.40 ±.02 (10.0 ±0.5)	.40 ±.02 (10.0 ±0.5)	.40 ±.02 (10.0 ±0.5)	.49 ±.02 (12.5 ±0.5)	.49 ±.02 (12.5 ±0.5)
W – Body Width	.28 ±.02 (7.0 ±0.5)	.32 ±.02 (8.0 ±0.5)	.40 ±.02 (10.0 ±0.5)	.40 ±.02 (10.0 ±0.5)	.40 ±.02 (10.0 ±0.5)	.49 ±.02 (12.5 ±0.5)	.49 ±.02 (12.5 ±0.5)

ORDERING INFORMATION

NSP1 7 1K 5%			
Type	Wattage	Resistance	Tolerance

www.DataSheet4U.com

NOTES

1. Bulk packaging only.

Vertical Mount Ceramic Wirewound Resistors

SEI Type NSM

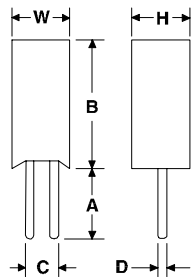

- Flame Proof Construction
- Low Ohmic Values
- Wound on Fiberglass Core
- Temperature Coefficient of $\pm 200 \text{ppm}/^\circ\text{C}$

PERFORMANCE CHARACTERISTICS

ELECTRICAL	NSM 2	NSM 3	NSM 5	NSM 7
Power Rating (Watts)	2 @ 25°C	3 @ 25°C	5 @ 25°C	7 @ 25°C
Derated to 0 Load at	250°C	250°C	250°C	250°C
Maximum Working Voltage	100V	200V	300V	350V
Operating Temperature Range	-55°C to +250°C	-55°C to +250°C	-55°C to +250°C	-55°C to +250°C
Resistance Range	0.1 – 680Ω	0.1 – 510Ω	0.1 – 510Ω	0.1Ω – 2K
Tolerance	±5%	±5%	±5%	±5%
Dielectric Withstand Voltage	500 volts RMS	500 volts RMS	500 volts RMS	500 volts RMS
ENVIRONMENTAL (Operating Temperature Range: -55°C to +250°C)				
Moisture Resistance	±5%	±5%	±5%	±5%
Thermal Shock	±2%	±2%	±2%	±2%
Load Life @ 70°C – 1,000 hrs	±5%	±5%	±5%	±5%
Resistance to Soldering Heat	±2%	±2%	±2%	±2%
Short Time Overload	±2%	±2%	±2%	±2%

DERATING CURVE

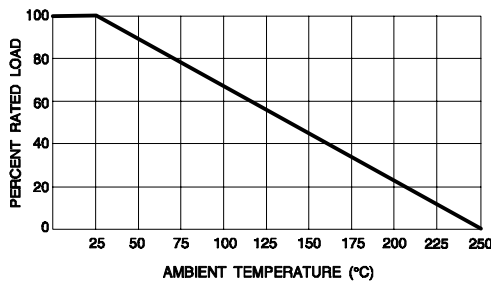

DIMENSIONS: Inches (mm)

FEATURE	NSM 2	NSM 3	NSM 5	NSM 7
A – Lead Length (typ.)	.20 min. (5.1 min.)	.20 min. (5.1 min.)	.20 min. (5.1 min.)	.20 min. (5.1 min.)
B – Body Length	.81 max. (20.5 max.)	.98 max. (25.0 max.)	1.00 max. (25.4 max.)	1.54 max. (39.0 max.)
C – Lead Spacing	.20 ±.01 (5.0 ±0.3)	.20 ±.01 (5.0 ±0.3)	.20 ±.01 (5.0 ±0.3)	.20 ±.01 (5.0 ±0.3)
D – Lead Diameter	.031 ±.002 (0.80 ±0.05)	.031 ±.002 (0.80 ±0.05)	.031 ±.002 (0.80 ±0.05)	.031 ±.002 (0.80 ±0.05)
H – Body Thickness	.38 max. (9.5 max.)	.38 max. (9.5 max.)	.38 max. (9.5 max.)	.38 max. (9.5 max.)
W – Body Width	.43 max. (11.0 max.)	.47 max. (12.0 max.)	.51 max. (13.0 max.)	.51 max. (13.0 max.)

ORDERING INFORMATION

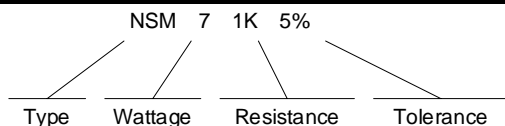

NOTES

1. Bulk packaging only.

Packaging – Axial Lead

PACKAGING & IDENTIFICATION VARIATIONS

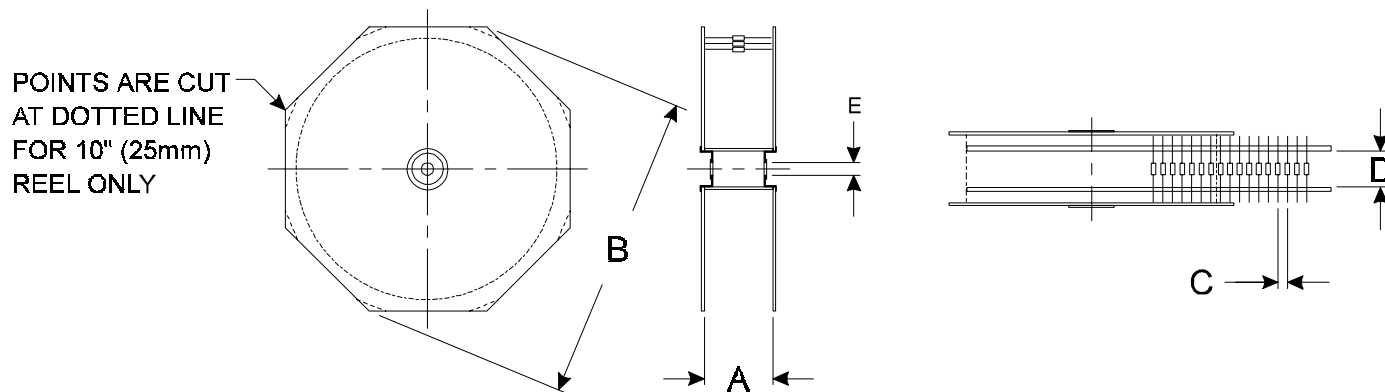

LEAD TAPE SPECIFICATIONS: Reeled in accordance with RS-296-E Inch (mm)

DIMENSIONS	A max.	B max.	C	D	E	Tape
Class I	See Note 1	13 ¹ / ₂ (343)	See Note 2	2 ¹ / ₁₆ (52.4)	⁹ / ₁₆ (14.3)	¹ / ₄ (6.35)
Class II	See Note 1	13 ¹ / ₂ (343)	See Note 2	2 ¹ / ₂ (63.5)	⁹ / ₁₆ (14.3)	¹ / ₄ (6.35)
Class III	See Note 1	13 ¹ / ₂ (343)	See Note 2	2 ⁷ / ₈ (73)	⁹ / ₁₆ (14.3)	¹ / ₄ (6.35)

Note 1. The A dimension shall be governed by the overall length of the taped component. The distance between flanges shall be .059 (1.50) to .315 (8.00) greater than the overall component.

Note 2.

<u>Component Diameter</u>	<u>Component Pitch</u>
0 to .197 (0 to 5.0)	.200 ±.020 (5.0 ±0.5)
.197 to .394 (5.0 to 10.0)	.400 ±.020 (10.0 ±0.5)

REEL QUANTITIES:

COMPONENT	Standard Qty / Reel	Opt. Qty at Additional Cost
RC 1/4, RC 1/2	5,000	2,500
RC 1/4 (with Kraft paper)	5,000	2,500
RC 1/2 (with Kraft paper)	2,500	—
CD, CF 1/8, 1/4, 1/2	5,000	—
LV, RN, MP 1/8, 1/4, RSM 1/2, RLFS 1/2, RMF 1/2, RMG 1/16, RMG 1/4, FRN 1/4	5,000	2,500
RLFS 1, RLFS 2, RMF 1, RMF 2, RMG 1/2, CRMG 1/2	3,000	N/A
LV, RN, MP 1/2, RS 1/2, RS 1, RSM 1, RSM 2, FRN 1/2, FRN 1	2,500	N/A
RS 2, RSM 3, FRN 2, RLFS 3, RMF 3, RMG 1, RMG 2	1,000	N/A
RS 3, RSM 5	500	N/A
WRF 1, WRF 2, WRF 3	2,000	N/A

Note: SEI resistors are reeled per Class I, RS-296-E with the following exceptions:
 RS 2, RS 3, RSM 3, RSM 5, RLFS 3, RMF 3, RMG 2, FRN 2, WRF 2 & WRF 3 – Standard per Class II.
 RMG 2 – Standard per Class III
 RS 2, RSM 3 – Class III available at additional cost.
 RS 5, RLFS 5 & RMF 5 – Available bulk package only.

PACKAGING: NETWORKS

- All SEI networks are bulk packed (1,000 pieces standard).
- Optional lead taping is now available.

PACKAGING: BULK

1,000 piece quantity is standard.

Packaging – Radial Lead

RADIAL LEAD TAPING SPECIFICATION – PANA-SERT Carbon Film & Metal Film Resistors (1/4W Body Size)

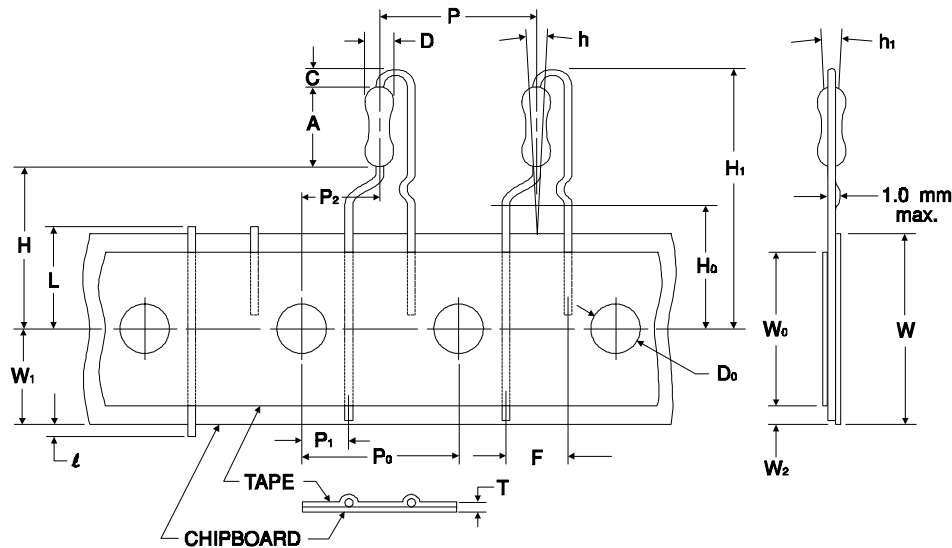

Description	Symbol	PANA-SERT Inches (mm)
Resistor body diameter	D	.090 ±.008 (2.3 ±0.2)
Resistor body length	A	.256 ±.020 (6.5 ±0.5)
Resistor pitch ¹	P	.500 ±.039 (12.7 ±1.0)
Sprocket-hole pitch ¹	P ₀	.500 ±.012 (12.7 ±0.3)
Sprocket-hole center to lead center	P ₁	.152 ±.028 (3.85 ±0.7)
Sprocket-hole center to resistor center ¹	P ₂	.250 ±.051 (6.35 ±1.3)
Resistor lead spacing	F	.197 ±.039 (5.0 ±1.0)
Resistor alignment	h	0.0 ±.079 [0 ±5°] (0 ±2.0 [0 ±5°])
Chipboard width ¹	W	.709 +.039/-0.020 (18.0 +1.0/-0.5)
Hold-down tape width	W ₀	.492 (12.5) min.
Sprocket-hole position	W ₁	.354 +.030/-0.020 (0.9 +0.75/-0.5)
Hold-down tape position	W ₂	.118 (3.0) max.
Height to bottom of resistor	H	.748 ±.039 (19.0 ±1.0)
Height to lead clinch	H ₀	.630 ±.020 (16.0 ±0.5)
Lead protrusion	l	.079 (2.0) max.
Sprocket-hole diameter	D ₀	.157 ±.012 (4.0 ±0.3)
Thickness (chipboard and tape)	T	.028 ±.008 (0.7 ±0.2)
Cutout length ¹	L	.433 (11.0) max.
Height of resistor	H ₁	1.122 (28.5) max.
Height of bending	C	.098 ±.020 (2.5 ±0.5)
Resistor alignment	h ₁	0.0 ±.079 [0 ±5°] (0 ±2.0 [0 ±5°])

Note 1. Cumulative pitch tolerances not to exceed ±.039 (±1.0) over 20 consecutive pitches.
2500 pieces per reel.

Note 2. Product only available from 10Ω to 1 meg in 5% or 1% tolerances.

Packaging – Chip Resistors

CHIP RESISTOR REEL NOMINAL DIMENSIONS Inches (mm)

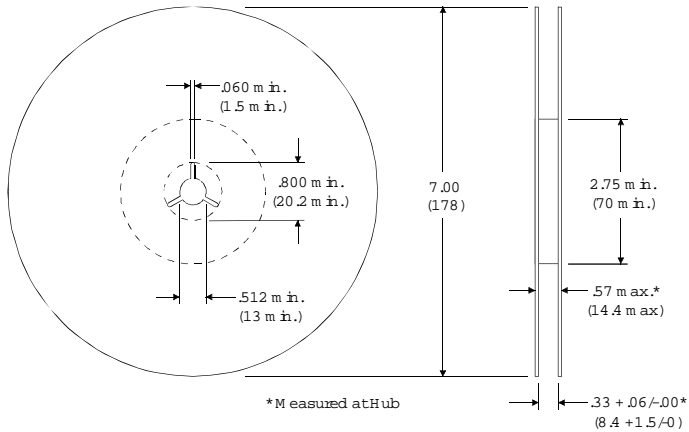

PACKAGING: CHIPS Per EIA Standard RS-481

A	B	C	D	E	F	G	H	J ¹		
.16 ±.01 (4.0 ±0.1)	.08 ±.01 (2.0 ±0.1)	.16 ±.01 (4.0 ±0.1)	.06 +.01/-0 (1.5 +0.1/-0)	.04 (1.0)	.069 (1.75)	.20 (5.0)	.138 ±.002 (3.50 ±0.05)	.32 ±.01 (8.0 ±0.1)		
						K1	K2	L	M	
						RGC 1/16, RMC 1/16, RNC 16	.04 max. (1.1 max.)	—	.04 ±.01 (1.1 ±0.2)	.08 ±.01 (1.9 ±0.2)
						RGC 1/10, RMC 1/10, HMC 1/16, FCR 1/10	.04 max. (1.1 max.)	—	.065 ±.008 (1.65 ±0.20)	.09 ±.01 (2.4 ±0.2)
						RGC 1/8, RMC 1/8, HMC 1/8, FCR 1/8	.04 max. (1.1 max.)	.09 max. (2.4 max.)	.08 ±.01 (2.0 ±0.1)	.138 ±.002 (3.50 ±0.05)
						RMC 1/4, FCR 1/4	—	.09 max. (2.4 max.)	.11 ±.01 (2.8 ±0.2)	.14 ±.01 (3.6 ±0.2)
						RMC 1/2	—	.09 max. (2.4 max.)	.11 ±.01 (2.8 ±0.2)	.21 ±.01 (5.3 ±0.2)
						RMC 1	—	.09 max. (2.4 max.)	.15 ±.01 (3.8 ±0.2)	.26 ±.01 (6.6 ±0.2)
						RNC 20	.04 max. (1.1 max.)	—	.065 ±.008 (1.65 ±0.20)	.09 ±.01 (2.4 ±0.2)
						RNC 32	.04 max. (1.1 max.)	.09 max. (2.4 max.)	.08 ±.01 (2.0 ±0.1)	.138 ±.002 (3.50 ±0.05)

- Notes: 1. Dimensions are 0.47 ±.01 (12.0 ±0.1) for 1/2 and 1 Watt.
2. 5,000 per (7") reel – 1/16, 1/10 & 1/8 Watt. 4,000 per (7") reel – 1/4, 1/2 & 1 Watt.
3. Available Options – 10,000 piece (13") reels. Embossed tape (standard on 1/4, 1/2 & 1 Watt; optional on 1/8 Watt).

PACKAGING: RMC 1/16S and RGC 1/16S CHIPS (2mm Pitch)

A	B	C	D	E
.026+.004/-0.002 (0.65+0.10/-0.05)	.045+.004/-0.002 (1.15+0.10/-0.05)	.315 ±.008 (8.00 ±0.20)	.138 ±.002 (3.50 ±0.05)	.069 ±.004 (1.75 ±0.10)
F	G	J	K	L
.079 ±.002 (2.00 ±0.05)	.039 ±.002 (1.00 ±0.05)	.059+.004/-0.000 (1.50+0.10/-0.00)	.016+.002/-0.000 (0.40+0.05/-0.00)	.020 max. (0.50 max.)

Standard Tape Packaging
2mm Pitch – 10,000 per reel
Reel diameter – 7.0 (178)
Reel width – .315 (8.0)

Note: Packaging specifications for RAC, RAV, SRL, and SRW are provided on the individual product data sheets.

Packaging – Lead Forming Capabilities

CUT & FORMED LEADS

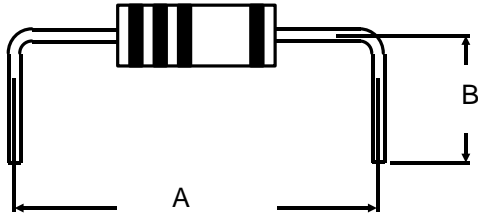

TYPE	A ±.015	B ±.015
RC 1/4, CF 1/4, CF 1/8, RN 1/4 & RN 1/8	.375 min. / 1.540 max. ² (9.53 min. / 39.12 max. ²)	.190 min. / .610 max. ² (4.83 min. / 15.49 max. ²)
RC 1/2, CF 1/2 & RN 1/2	.510 min. / 1.540 max. ² (12.95 min. / 39.12 max. ²)	.190 min. / .610 max. ² (4.83 min. / 15.49 max. ²)

NOTES

1. Horizontal cuts only.
2. Maximum combined dimensions = 1.970 (50.00).
3. 5,000 piece minimum per item & value with 25,000 piece minimum release per schedule date.
4. Contact factory for adder.

PREFORMED SWAGED LEADS

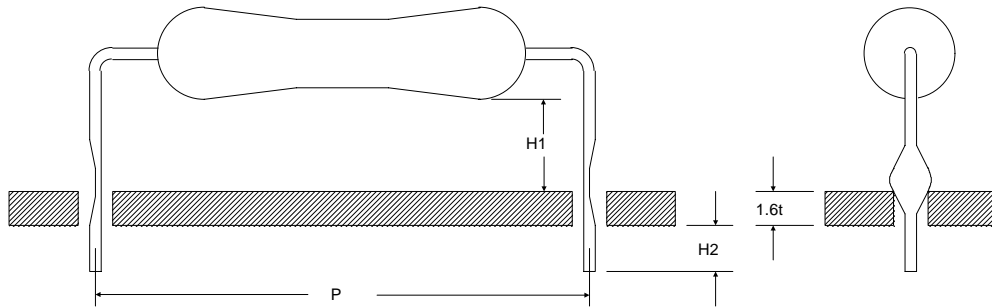

All tolerances ±.04 (1.0)	P	.49 (12.5)	.59 (15.0)	.79 (20.0)	.98 (25.0)	1.18 (30.0)
RSM 1/2	H1	.26 (6.5)				
	H2	.18 (4.5)				
RSM 1, RS 1/2	H1	.30 (7.5)	.30 (7.5)			
	H2	.18 (4.5)	.18 (4.5)			
RSM 2, RS 1	H1		.33 (8.5)	.33 (8.5)		
	H2		.18 (4.5)	.18 (4.5)		
RSM 3, RS 2	H1			.30 (7.5)	.30 (7.5)	
	H2			.18 (4.5)	.18 (4.5)	
RSM 5, RS 3	H1					.30 (7.5)
	H2					.18 (4.5)

NOTES

1. Contact factory for adder.

General Product Information

TEMPERATURE COEFFICIENT CODES

SEI Code	MIL Code	Temperature Coefficient	Temperature Span	Marking Method
T00	N/A	±200ppm/°C	-55°C to +150°C	N/A
T0	N/A	±150ppm/°C	-55°C to +165°C	N/A
T1	D	±100ppm/°C	-55°C to +165°C	N/A
T2	C	±50ppm/°C	-55°C to +175°C	Red dash between 4th & 5th color band
T9	E	±25ppm/°C	-55°C to +175°C	White dash between 4th & 5th color band

TOLERANCE CODES

SEI/MIL Reference	Tolerance
K	±10%
J	±5%
G	±2%
F	±1%
D	±0.5%
C	±0.25%
B	±0.1%

RESISTANCE VALUES

SEI Standard for Nominal Values & Tolerances	
Series	Tolerance
E12	±10%
E24	±5%, ±2%
E96	±1%
E192	±0.5%, ±0.25%, ±0.1%

Notes: 1. Non-standard R values are available. Consult factory for minimum order quantities.

COMPONENT FLAMMABILITY

SEI Electronics Product Type	Polymer Type	IEC 695-2-2	UL94V Rating	Total Polymer Mass	Oxygen Index
Carbon Films					
CF 1/8 (CFM 1/4)	Epoxy	*	N/A	3 mg	N/A
CF 1/4 (CFM 1/2)	Epoxy	*	N/A	15 mg	N/A
CF 1/2	Epoxy	*	N/A	20 mg	N/A
Metal Films					
RN 1/8 (RNM 1/4)	Epoxy	*	N/A	3 mg	N/A
RN 1/4 (RNM 1/2)	Epoxy	*	N/A	15 mg	N/A
RN 1/2	Epoxy	*	N/A	20 mg	N/A
Metal Oxides					
RSM 1/2	Silicone		94V-0	20 mg	46 - 48%
RSM 1 (RS 1/2)	Silicone		94V-0	30 mg	46 - 48%
RSM 2 (RS 1)	Silicone		94V-0	50 mg	46 - 48%
RSM 3 (RS 2)	Silicone		94V-0	130 mg	46 - 48%
RSM 5 (RS 3)	Silicone		94V-0	500 mg	46 - 48%
RS 5	Silicone		94V-0	400 mg	46 - 48%
Chip Resistors					
RMC Series	Boro-Silicated Acid Lead Glass	*	94V-0	N/A	N/A
Resistor Networks					
LC5X	Epoxy	*	94V-0	70 mg	N/A
LC6X	Epoxy	*	94V-0	80 mg	N/A
LC7X	Epoxy	*	94V-0	90 mg	N/A
LC8X	Epoxy	*	94V-0	110 mg	N/A
LC9X	Epoxy	*	94V-0	120 mg	N/A
LC0X	Epoxy	*	94V-0	140 mg	N/A
Chip Networks					
RAC Series	Boro-Silicated Acid Lead Glass	*	94V-0	N/A	N/A
RAV Series	Boro-Silicated Acid Lead Glass	*	94V-0	N/A	N/A

* Meets Specification

Resistor Selection Guide

FOR SEI 1/4 WATT GENERAL PURPOSE RESISTORS

PERFORMANCE	CARBON COMPOSITION RC 1/4	CARBON FILM CF 1/4	METAL FILM MP 1/4
Power Rating	1/4W @ 70°C	1/4W @ 70°C	1/4W @ 70°C
Dimensions: Inches (mm) Body Length x Diameter Lead Length x Diameter Clean Lead to Clean Lead	.248 x .094 (6.30 x 2.40) 1.10 x .024 (28.0 x 0.60) .276 (7.0)	.24 x .09 (6.0 x 2.3) 1.10 x .022 (28.0 x 0.55) .281 (7.14) max.	.24 x .09 (6.0 x 2.3) 1.10 x .022 (28.0 x 0.55) .281 (7.14) max.
1000 hour Load Life (1/4W @ 70°C)	±5% ΔR	±3% ΔR	±0.5% ΔR
Temperature Coefficient	+500 to -1100ppm/°C (varies with resistance value)	-300 to -2000ppm/°C (varies with resistance value)	±100ppm/°C
Moisture Resistance	±5% ΔR	±3% ΔR	±0.5% ΔR
Shelf Drift	±2%/year ΔR	±0.25%/year ΔR	±0.1%/year ΔR
Current Noise	-25db to +30db	-35db to 0db	-40db to -5db
Resistance Range	2.2Ω to 5.6 megohms	1.0Ω to 10 megohms	1.0Ω to 10 megohms
Resistance Tolerance	±5%	±5%	±5%
Short Time Overload	±2% ΔR	±0.75% ΔR	±0.25% ΔR
Maximum Continuous Working Voltage	250V RMS	250V RMS	250V RMS
Dielectric Withstanding Voltage	500V RMS	500V RMS	500V RMS
Temperature Cycling	±2% ΔR	±1% ΔR	±0.25% ΔR
Resistance to Soldering Heat	±3% ΔR	±0.5% ΔR	±0.1% ΔR
For additional information, refer to: Carbon Composition Resistors on page D-5 Carbon Film Resistors on pages D-1 Metal Film Resistors on pages C-3			

www.DataSheet4U.com

SEI Electronics Inc. • P.O. Box 58789 • Raleigh, NC 27658-8789 • Telephone: (919) 850-9500 • FAX: (919) 850-9504
Toll Free: (888) SEI-SEI-SEI • www.seielect.com • email: marketing@seielect.com • ISO 9002 Registered

Resistor Selection Guide

PERFORMANCE/APPLICATION CONSIDERATIONS				
	CARBON COMPOSITION	CARBON FILM	METAL FILM	METAL OXIDE
POWER RATING RANGE	2	2	2	1
RESISTANCE VALUE RANGE	2	1	3	4
TOLERANCE	4	3	1	2
STABILITY	4	3	1	2
TCR	4	3	1	2
VOLTAGE COEFFICIENT	3	2	1	1
NOISE	4	3	1	2
FREQUENCY RESPONSE	2	1	1	1
DIELECTRIC STRENGTH	1	2	3	3
INSULATION RESISTANCE	1	2	2	2
TEMPERATURE CYCLING	3	2	1	2
LOW TEMPERATURE OPERATION	3	2	1	2
MOISTURE RESISTANCE	3	2	1	2
EFFECT OF SOLDERING	3	2	1	2
SHELF DRIFT	3	2	1	2
FLAMMABILITY	3	2	2	1
PULSE LOAD CAPACITY	1	3	3	2
RELIABILITY	1	3	2	2
COST	4	1	2	3
AVAILABILITY	4	1	2	3
COST-AVAILABILITY-PERFORMANCE BALANCE	4	3	1	2

* Lowest number is best

www.DataSheet4U.com