

# ROV14, ROV14H, ROV14E

## 14mm Series Metal Oxide Varistors

www.tycopowercomponents.com

Document: SCD 25483  
 Status: Released  
 Rev.: A June 30, 2003

### GENERAL DESCRIPTION

The ROV14-XXX (**R**adial-leaded Metal **O**xide **V**aristor) products are 14mm radial leaded varistor devices suitable for protection of overvoltage transients.

ROV devices can provide protection for a wide variety of power systems against overvoltage faults such as lightning, power contact and power induction. Suitable for a broad range of applications including, but not limited to security, power supplies, surge strips, etc., the ROV device helps to protect valuable equipment from potential power surge damage by clamping high energy, short duration impulses. The ROV devices have high current handling and energy absorption capability and fast response times to help protect against transient faults.

### FEATURES

- Radial leaded
- Broad Varistor voltage and  $V_{rms}$  range
  - Varistor voltage : 18V - 1800V
  - $V_{rms}$  voltage : 11V - 1000V
- Three surge capability series
  - Standard series, High surge series, Extra high surge Series
- Various lead types
  - Straight, Kinked, Other
- Various packaging options
  - Bulk, Tape & Reel, Ammo Pack
- Helps designers meet the following standards
  - UL, CSA, VDE
- Fast response time
- High current and energy absorption capability

### APPLICATIONS

- Power supplies and power systems
- Line voltage
- Telecommunications systems
- Automotive systems
- Appliances

### TYPICAL APPLICATION SCHEMATIC

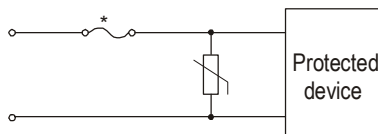

\*In some applications, a polymeric PTC device such as a Tyco Electronics PolySwitch device may be used instead of a fuse to provide a preferred solution.

# ROV14, ROV14H, ROV14E

## 14mm Series Metal Oxide Varistors

www.tycopowercomponents.com

Document: SCD 25483  
Status: Released  
Rev.: A June 30, 2003

### PART NUMBERING

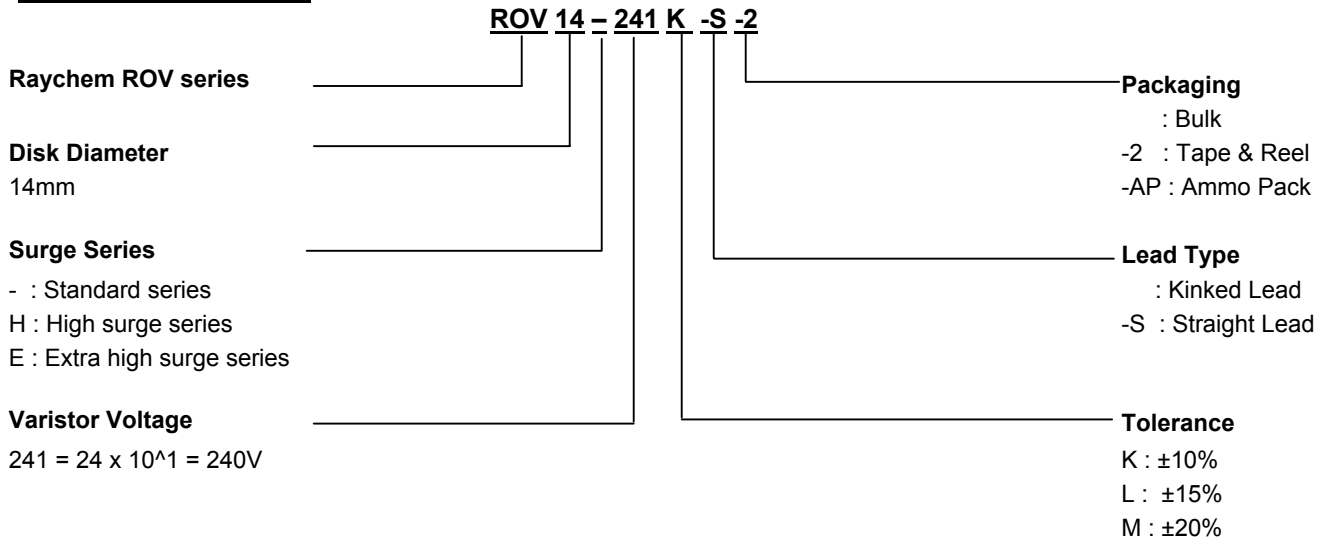

### DEVICE MARKING

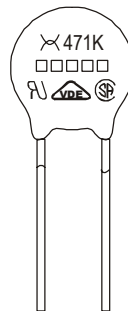
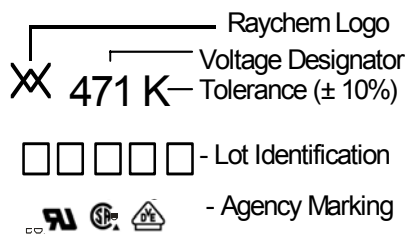

### GENERAL CHARACTERISTICS

Storage temperature:	-40°C ... +125°C
Maximum operating temperature:	-40°C ... +125°C
Maximum working surface temperature:	+115°C
Temperature coefficient of voltage:	0....+0.05% / °C max.
Insulation resistance of coating (@ 500 VDC):	Over 1000MΩ
Maximum response time:	25ns
Lead Material:	22 AWG Sn/Pb Plated Copper

### AGENCY RECOGNITION

Device Ratings and Characteristics Tables contain specific recognition information for each individual part. The table below details marking symbols for each agency recognition type.

UL1414	UL1449 (2nd Edition)	CSA	VDE
◆	●	▲	■

# ROV14, ROV14H, ROV14E

## 14mm Series Metal Oxide Varistors

www.tycopowercomponents.com

Document: SCD 25483  
 Status: Released  
 Rev.: A June 30, 2003

### DEVICE RATINGS AND CHARACTERISTICS

#### STANDARD SERIES

Part Number	Varistor Voltage V@1.0mA		Maximum Allowable Voltage		Maximum Clamping Voltage V@50A	Maximum Surge Current (8x20us)		Rated Wattage	Energy (10x1000us)	Capacitance (Typical)	Certifications
	(V <sub>DC</sub> )	Tolerance	V <sub>rms</sub> (V <sub>AC</sub> )	(V <sub>DC</sub> )	(V <sub>DC</sub> )	1 Time (A)	2 Times (A)	(W)	(J)	@1kHz (pF)	
			(V <sub>DC</sub> )	(V <sub>DC</sub> )	(V <sub>DC</sub> )	(A)	(A)	(W)	(J)	(pF)	
ROV14-180M	18	± 20%	11	14	36 <sup>1)</sup>	1000	500	0.10	4.7	14898	● ■
ROV14-220L	22	± 15%	14	18	43 <sup>1)</sup>				5.4	11957	● ■
ROV14-270K	27	± 10%	17	22	53 <sup>1)</sup>				6.9	9731	● ■
ROV14-330K	33		20	26	65 <sup>1)</sup>				8.8	7704	● ■
ROV14-390K	39		25	31	77 <sup>1)</sup>				9.4	7622	● ■
ROV14-470K	47		30	38	93 <sup>1)</sup>				12.0	6417	● ■
ROV14-560K	56		35	45	110 <sup>1)</sup>				14.0	5184	● ■
ROV14-680K	68		40	56	135 <sup>1)</sup>				17.0	5099	● ■
ROV14-820K	82		50	65	135				22.0	2965	● ■
ROV14-101K	100		60	85	165				28.0	2221	● ■
ROV14-121K	120		75	100	200	32.0	1742	● ■			
ROV14-151K	150		95	125	250	44.0	1510	● ■			
ROV14-181K	180	115	150	300	52.0	922	● ■				
ROV14-201K	200	130	170	340	57.0	845	◆ ● ▲ ■				
ROV14-221K	220	140	180	360	62.0	713	◆ ● ▲ ■				
ROV14-241K	240	150	200	395	67.0	769	◆ ● ▲ ■				
ROV14-271K	270	175	225	455	79.0	655	◆ ● ▲ ■				
ROV14-301K	300	195	250	505	84.0	650	◆ ● ▲ ■				
ROV14-331K	330	210	275	550	92.0	613	◆ ● ▲ ■				
ROV14-361K	360	230	300	595	104.0	465	◆ ● ▲ ■				
ROV14-391K	390	250	320	650	120.0	458	◆ ● ▲ ■				
ROV14-431K	430	275	350	710	132.0	454	◆ ● ▲ ■				
ROV14-471K	470	300	385	775	140.0	413	◆ ● ▲ ■				
ROV14-511K	510	320	418	842	148.0	374	◆ ● ▲ ■				
ROV14-561K	560	350	460	920	156.0	398	◆ ● ▲ ■				
ROV14-621K	620	385	505	1025	164.0	305	◆ ● ▲ ■				
ROV14-681K	680	420	560	1120	172.0	312	◆ ● ▲ ■				
ROV14-751K	750	460	615	1240	180.0	270	◆ ● ▲ ■				
ROV14-781K	780	485	640	1290	184.0	252	◆ ● ▲ ■				
ROV14-821K	820	510	670	1355	188.0	265	◆ ● ▲ ■				
ROV14-911K	910	550	745	1500	204.0	240	◆ ● ▲ ■				
ROV14-102K	1000	625	825	1650	224.0	200	◆ ● ▲ ■				
ROV14-112K	1100	680	895	1815	248.0	180	◆ ● ▲ ■				
ROV14-182K	1800	1000	1465	2970	348.0	118					

1). The clamping voltage for devices ROV14-180M to ROV14-680K is tested with 10A current.

# ROV14, ROV14H, ROV14E 14mm Series Metal Oxide Varistors

www.tycopowercomponents.com

Document: SCD 25483  
Status: Released  
Rev.: A June 30, 2003

## PULSE LIFETIME RATING CURVES STANDARD SERIES

## V-I CHARACTERISTIC CURVES STANDARD SERIES

**ROV14-180M – ROV14-680K**

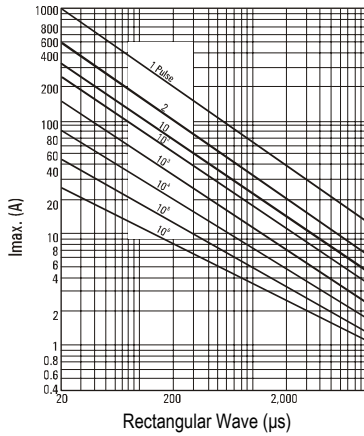

**ROV14-180M – ROV14-680K**

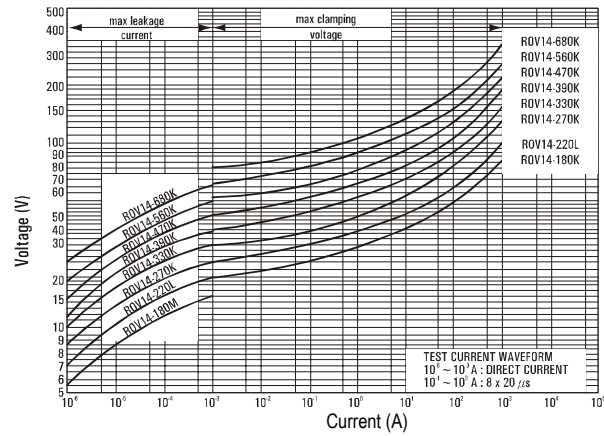

**ROV14-820K – ROV14-511K**

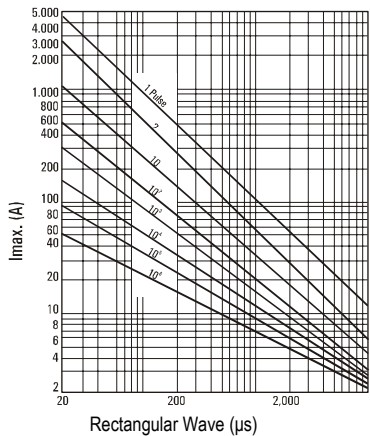

**ROV14-820K – ROV14-511K**

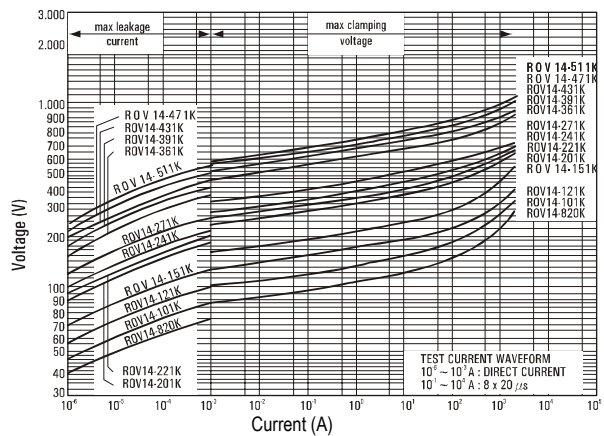

**ROV14-561K – ROV14-182K**

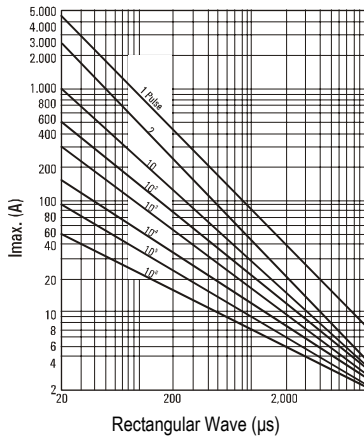

**ROV14-561K – ROV14-182K**

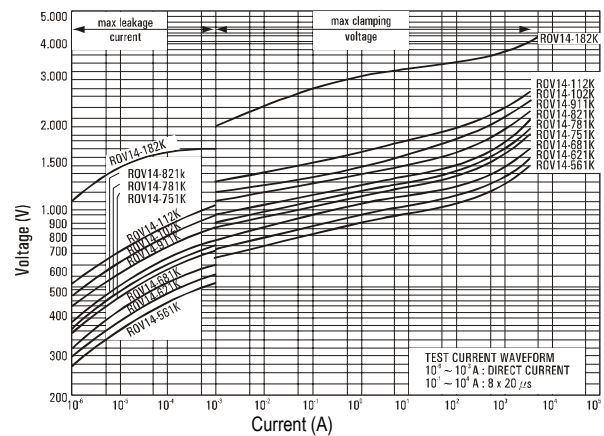

# ROV14, ROV14H, ROV14E

## 14mm Series Metal Oxide Varistors

www.tycopowercomponents.com

Document: SCD 25483  
 Status: Released  
 Rev.: A June 30, 2003

### DEVICE RATINGS AND CHARACTERISTICS

#### HIGH SURGE SERIES

Part Number	Varistor Voltage V@1.0mA		Maximum Allowable Voltage		Maximum Clamping Voltage V@50A	Maximum Surge Current (8x20us)		Rated Wattage	Energy (10x1000us)	Capacitance (Typical)	Certifications
	(V <sub>DC</sub> )	Tolerance	V <sub>rms</sub> (V <sub>AC</sub> )	(V <sub>DC</sub> )	(V <sub>DC</sub> )	1 Time (A)	2 Times (A)	(W)	(J)	@1kHz (pF)	
ROV14H180M	18	± 20%	11	14	36 <sup>1)</sup>	2000	1000	0.10	5.2	14890	● ■
ROV14H220L	22	± 15%	14	18	43 <sup>1)</sup>				6.3	11960	● ■
ROV14H270K	27	± 10%	17	22	53 <sup>1)</sup>				7.8	9730	● ■
ROV14H330K	33		20	26	65 <sup>1)</sup>				9.5	7700	● ■
ROV14H390K	39		25	31	77 <sup>1)</sup>				11.0	7620	● ■
ROV14H470K	47		30	38	93 <sup>1)</sup>				14.0	6420	● ■
ROV14H560K	56		35	45	110 <sup>1)</sup>				16.0	5180	● ■
ROV14H680K	68		40	56	135 <sup>1)</sup>				20.0	5100	● ■
ROV14H820K	82		50	65	135				28.0	2970	● ■
ROV14H101K	100		60	85	165				36.0	2220	● ■
ROV14H121K	120		75	100	200	44.0	1740	● ■			
ROV14H151K	150		95	125	250	53.0	1510	● ■			
ROV14H181K	180	115	150	300	65.0	920	● ■				
ROV14H201K	200	130	170	340	70.0	840	◆ ● ▲ ■				
ROV14H221K	220	140	180	360	78.0	710	◆ ● ▲ ■				
ROV14H241K	240	150	200	395	84.0	770	◆ ● ▲ ■				
ROV14H271K	270	175	225	455	99.0	650	◆ ● ▲ ■				
ROV14H301K	300	195	250	505	105.0	650	◆ ● ▲ ■				
ROV14H331K	330	210	275	550	115.0	610	◆ ● ▲ ■				
ROV14H361K	360	230	300	595	130.0	470	◆ ● ▲ ■				
ROV14H391K	390	250	320	650	140.0	460	◆ ● ▲ ■				
ROV14H431K	430	275	350	710	155.0	450	◆ ● ▲ ■				
ROV14H471K	470	300	385	775	175.0	420	◆ ● ▲ ■				
ROV14H511K	510	320	418	842	190.0	370	◆ ● ▲ ■				
ROV14H561K	560	350	460	920	205.0	400	◆ ● ▲ ■				
ROV14H621K	620	385	505	1025	215.0	300	◆ ● ▲ ■				
ROV14H681K	680	420	560	1120	225.0	310	◆ ● ▲ ■				
ROV14H751K	750	460	615	1240	230.0	270	◆ ● ▲ ■				
ROV14H781K	780	485	640	1290	233.0	250	◆ ● ▲ ■				
ROV14H821K	820	510	670	1355	235.0	260	◆ ● ▲ ■				
ROV14H911K	910	550	745	1500	255.0	240	◆ ● ▲ ■				
ROV14H102K	1000	625	825	1650	283.0	200	◆ ● ▲ ■				
ROV14H112K	1100	680	895	1815	310.0	180	◆ ● ▲ ■				

1). The clamping voltage for devices ROV14H180M to ROV14H680K is tested with 10A current.

# ROV14, ROV14H, ROV14E

## 14mm Series Metal Oxide Varistors

www.tycopowercomponents.com

Document: SCD 25483  
Status: Released  
Rev.: A June 30, 2003

### PULSE LIFETIME RATING CURVES HIGH SURGE SERIES

### V-I CHARACTERISTIC CURVES HIGH SURGE SERIES

**ROV14H180M – ROV14H680K**

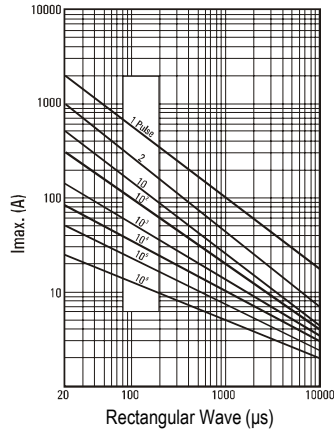

**ROV14H180M – ROV14H680K**

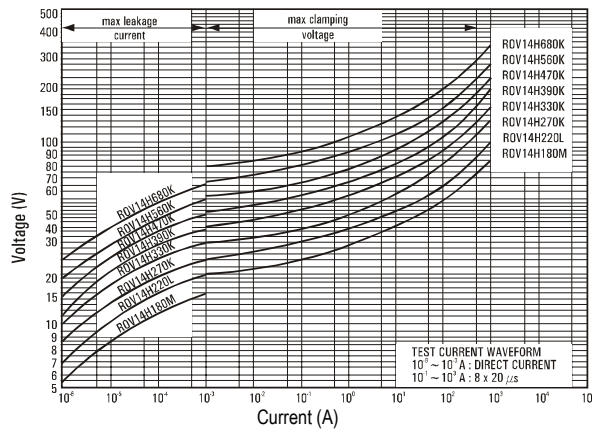

**ROV14H820K – ROV14H511K**

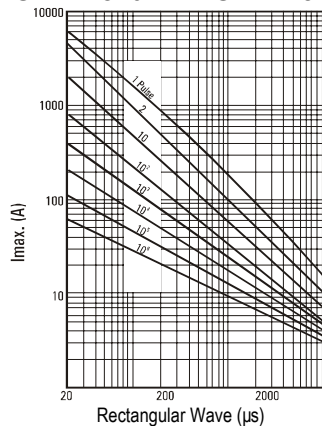

**ROV14H820K – ROV14H511K**

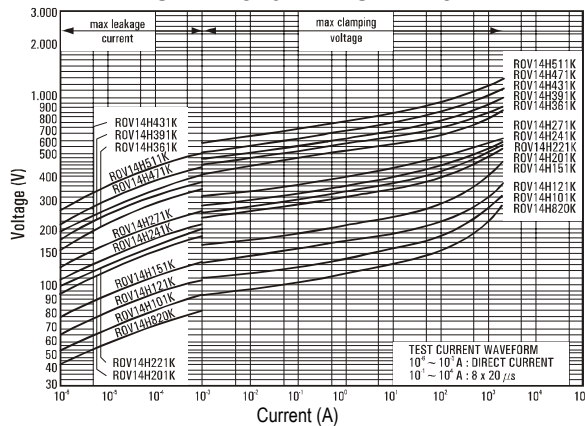

**ROV14H561K – ROV14H182K**

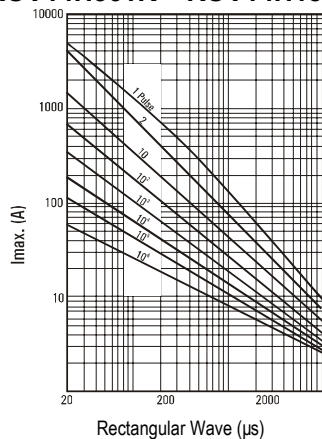

**ROV14H561K – ROV14H182K**

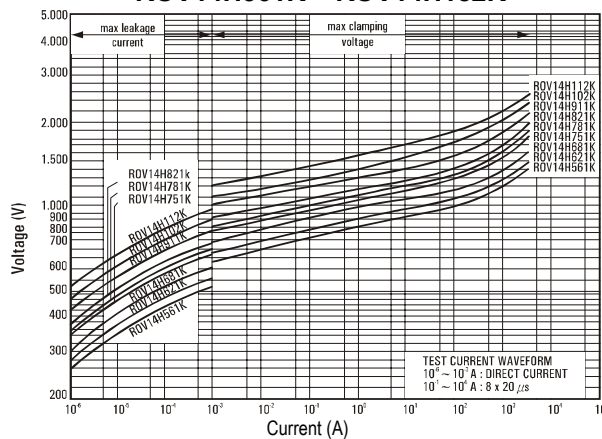

# ROV14, ROV14H, ROV14E

## 14mm Series Metal Oxide Varistors

www.tycopowercomponents.com

Document: SCD 25483  
Status: Released  
Rev.: A June 30, 2003

### DEVICE RATINGS AND CHARACTERISTICS

#### EXTRA HIGH SURGE SERIES

Part Number	Varistor Voltage V@1.0mA		Maximum Allowable Voltage		Maximum Clamping Voltage V@50A	Maximum Surge Current (8x20us)		Rated Wattage	Energy (10x1000us)	Capacitance (Typical)	Certifications
	(V <sub>DC</sub> )	Tolerance	V <sub>rms</sub> (V <sub>AC</sub> )	(V <sub>DC</sub> )	(V <sub>DC</sub> )	1 Time (A)	2 Times (A)	(W)	(J)	@1kHz (pF)	
ROV14E201K	200	± 10%	130	170	340	6500	6000	0.60	84.0	840	● ▲
ROV14E221K	220		140	180	360				93.0	710	● ▲
ROV14E241K	240		150	200	395				101.0	770	● ▲
ROV14E271K	270		175	225	455				113.0	-----	
ROV14E301K	300		195	250	505				126.0	-----	
ROV14E331K	330		210	275	550				138.0	-----	
ROV14E361K	360		230	300	595				151.0	-----	

# ROV14, ROV14H, ROV14E

## 14mm Series Metal Oxide Varistors

www.tycopowercomponents.com

Document: SCD 25483  
 Status: Released  
 Rev.: A June 30, 2003

### DIMENSIONS

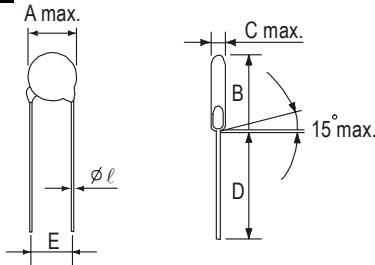

**KINKED LEAD TYPE**  
 Dimension Table

A max.	16.5
$l \pm 0.05$	0.8
$E \pm 1.0$	7.5
B max.	22.0
$D_1$ min.	25.0
D min.	24.0

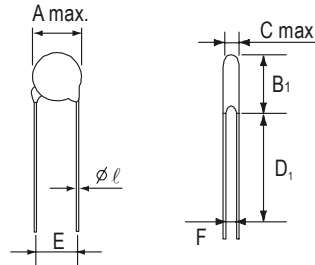

**STRAIGHT LEAD TYPE (-S)**  
 Table of C max., F, and B<sub>1</sub> max.

Type No.	C max.	F±0.8	B <sub>1</sub> max.
180M	5.0	0.9	19.5
220L	5.0	1.0	19.5
270K	5.2	1.1	19.5
330K	5.2	1.2	19.5
390K	5.2	1.4	19.5
470K	5.6	1.4	19.5
560K	5.6	1.6	19.5
680K	6.1	1.9	19.5
820K	4.4	1.0	19.5
101K	4.5	1.0	19.5
121K	4.6	1.1	19.5
151K	5.1	1.4	19.5
181K	4.7	1.2	19.5
201K	4.8	1.2	19.5
221K	4.9	1.3	19.5
241K	5.0	1.5	19.5
271K	5.2	1.5	19.5
301K	5.4	1.7	19.5
331K	5.5	1.7	19.5
361K	5.7	2.1	19.5
391K	5.9	2.2	20.0
431K	6.7	2.5	20.0
471K	7.0	2.7	20.0
511K	7.2	3.1	20.5
561K	7.5	3.4	20.5
621K	7.8	3.8	20.5
681K	8.2	4.1	20.5
751K	8.6	4.3	20.5
781K	8.8	4.6	20.5
821K	9.0	4.6	20.5
911K	9.6	5.4	20.5
102K	10.1	5.6	20.5
112K	10.7	6.1	20.5
182K	12.8	10.2	22.5



# ROV14, ROV14H, ROV14E

## 14mm Series Metal Oxide Varistors

www.tycopowercomponents.com

Document: SCD 25483  
Status: Released  
Rev.: A June 30, 2003

### PACKAGING

in mm

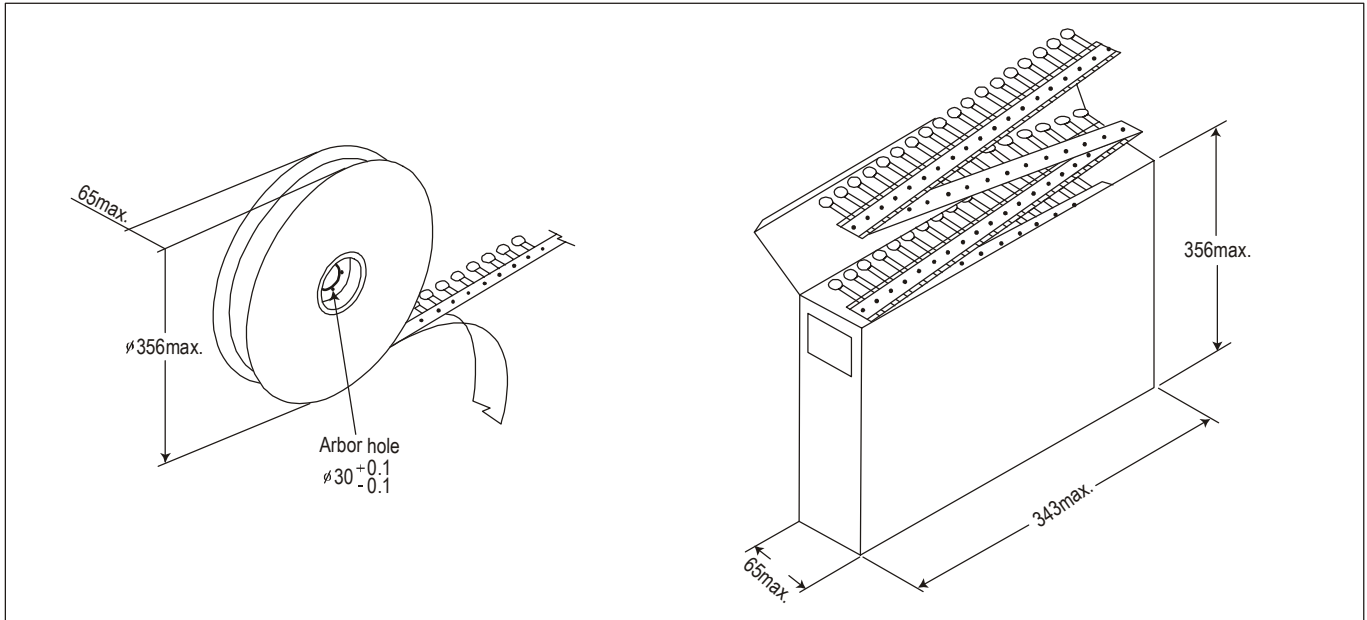

Packaging	Bulk (box)	Reel	Ammo
Box size (mm)	290 x 155 x 110	350 x 350 x 74	350 x 260 x 65
Carton size (mm)	310 x 328 x 250	370 x 370 x 468	365 x 535 x 275
One carton with	4 Boxes	6 Boxes (6 reels)	8 Boxes

Part Number	Bulk (box)	Reel	Ammo
ROV14-180M to ROV14-470K, ROV14H180M to ROV14H470K	1500	750	500
ROV14-560K to ROV14-680K, ROV14H560K to ROV14H680K	1500	750	500
ROV14-820K to ROV14-331K, ROV14H820K to ROV14H331K	1500	750	500
ROV14-361K to ROV14-391K, ROV14H361K to ROV14H391K	1500	750	500
ROV14-431K to ROV14-471K, ROV14H431K to ROV14H471K	1500	750	500
ROV14-511K to ROV14-751K, ROV14H511K to ROV14H751K	750	500	500
ROV14-751K to ROV14-182K, ROV14H751K to ROV14H112K	750	500	500

# ROV14, ROV14H, ROV14E

## 14mm Series Metal Oxide Varistors

www.tycopowercomponents.com

Document: SCD 25483

Status: Released

Rev.: A June 30, 2003

### TAPE AND REEL DIMENSIONS

1/2" Pitch

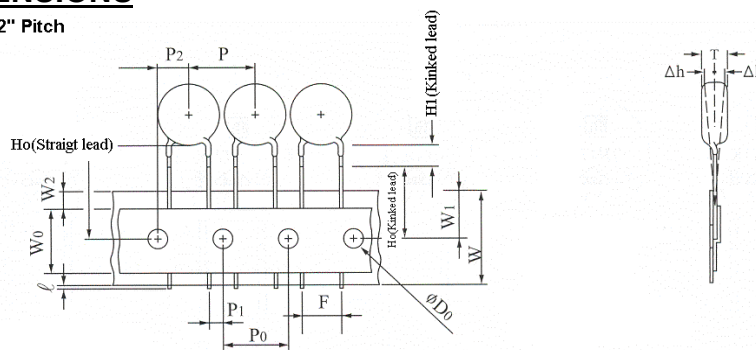

1.0" Pitch

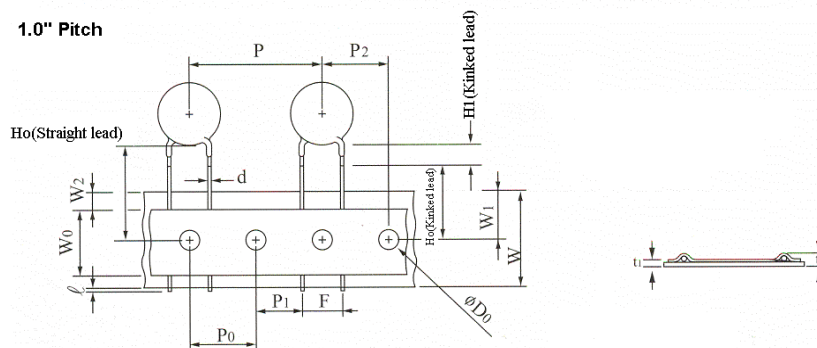

Symbols	Item	Value
$\ell$	Cut out length	1.1mm max.
$H_1$ (Kinked type)	Height of kink	5.0mm max.
$H_0$ (Kinked type)	Height to seating plane	$16.0 \pm 0.5$ mm
$H_0$ (Straight type)	Height of component from hole center	16.0-21.0mm
$\Delta h$	Front to back deviation	$0.0 \pm 2.0$ mm
$W$	Carrier tape width	$18.0^{+1.0}_{-0.5}$ mm
$W_0$	Hold down tape width	12.0mm
$W_1$	Sprocket hole position	$9.0^{+0.75}_{-0.5}$ mm
$W_2$	Adhesive tape position	3.0mm max.
$F$	Component lead spacing	$7.5^{+0.8}_{-0.2}$ mm
$P$	Pitch of component	$25.4 \pm 1.0$ mm
$P_0$	Sprocket hole pitch	$12.7 \pm 0.3$ mm
$P_1$	Lead length from hole center to lead	$7.7 \pm 0.7$ mm, $8.95 \pm 0.7$ mm
$P_2$	Length from hole center to disk center	$12.7 \pm 1.3$ mm
$D_0$	Sprocket hole diameter	$4.0 \pm 0.2$ mm
$d$	Lead wire diameter	$0.8 \pm 0.05$ mm, $1.0 \pm 0.05$ mm
$T$	Disk thickness	See C. max table
$t_1$	Total thickness tape	$0.7 \pm 0.05$ mm
$t_2$	Total thickness	1.8mm max.



# ROV14, ROV14H, ROV14E

## 14mm Series Metal Oxide Varistors

www.tycopowercomponents.com

Document: SCD 25483  
Status: Released  
Rev.: A June 30, 2003

---

Information furnished is believed to be accurate and reliable. However, users should independently evaluate the suitability of each product for their applications. Tyco Electronics Corporation assumes no responsibility for the use of its product or for any infringement of patents or other rights of third parties resulting from the use of its product. No license is granted by implication or otherwise under any patent or proprietary right of Tyco Electronics except the right to use such product for the purpose for which it is sold. Tyco Electronics reserves the right to change or update, without notice, any information contained in this publication; to change, without notice, the design, construction, processing, or specification of any product; and to discontinue or limit production or distribution of any product. This publication supersedes and replaces all information previously supplied. Without express written consent by an officer of Tyco Electronics, Tyco Electronics does not authorize the use of any its products as components in nuclear facility applications, aerospace, or in critical life support devices or systems. Tyco Electronics' only obligations are those in the Tyco Electronics Standard Terms and Conditions of Sale and in no case will Tyco Electronics be liable for any incidental, indirect, or consequential damages arising from the sale, resale, use, or misuse of its products.

**Raychem** is a trademark of Tyco Electronics Corporation

© 2003 Tyco Electronics Corporation