

2 A PWM/VFM Step-down DC/DC Converter with Synchronous Rectifier

NO.EA-296-130925

OUTLINE

The RP506x are low supply current CMOS-based PWM/VFM step-down DC/DC converters with synchronous rectifier featuring 2 A^{*1} output current. Internally, a single converter consists of an oscillator, a reference voltage unit, an error amplifier, a switching control circuit, a mode control circuit, a soft start circuit, a latch type protection circuit, an under-voltage lockout (UVLO) circuit, a thermal shutdown circuit, and switching transistors.

The RP506x is employing synchronous rectification for improving the efficiency of rectification by replacing diodes with built-in switching transistors. Using synchronous rectification not only increases circuit performance but also allows a design to reduce parts count.

Power controlling method can be selected from forced PWM control type or PWM/VFM auto switching control type by inputting a signal to the MODE pin. In low output current, forced PWM control switches at fixed frequency rate in order to reduce noise. Likewise, in low output current, PWM/VFM auto switching control automatically switches from PWM mode to VFM mode in order to achieve high efficiency.

Output voltage type can be selected from an internally fixed output voltage type (RP506Kxx1A/B/D/E) or an externally adjustable output voltage type (RP506K001C/F). The output voltage of the RP506Kxx1A/B/D/E can be set by 0.1 V step and the output voltage accuracy is as high as $\pm 1.5\%$ or ± 18 mV. The output voltage of the RP506K001C/F can be set by using the external resistors.

Oscillator frequency can be selected from 2.25 MHz (RP506Kxx1A/B/C) or 1.2 MHz (RP506Kxx1D/E/F). Soft-start time is Typ. 0.15 ms, and by connecting an external capacitor to the T_{SS} pin, soft-start time is adjustable.

Power good (PG) function monitors the V_{OUT} pin voltage or the feedback pin voltage (V_{FB}), and switches the PG pin to low if any abnormal condition is detected.

Protection circuits included in the RP506x are over current protection circuit, latch type protection circuit and thermal shutdown circuit. Over current protection circuit supervises the inductor peak current in each switching cycle, and if the current exceeds the L_x current limit (I_{LXLIM}), it turns off Pch Tr. Latch type protection circuit latches the built-in driver to the OFF state and stops the operation of the step-down DC/DC converter if the over current status continues or V_{OUT} continues being the half of the setting voltage for equal or longer than protection delay time (t_{prot}). Thermal shutdown circuit detects overheating of the converter if the output pin is shorted to the ground pin (GND) etc. and stops the converter operation to protect it from damage if the junction temperature exceeds the specified temperature.

The RP506x is available in DFN(PLP)2527-10 which achieves high-density mounting on boards.

^{*1} This is an approximate value. The output current is dependent on conditions and external components.

FEATURES

- Supply Current..... Typ. 48 μ A (VFM mode, Lx at no load)
- Standby Current..... Max. 5 μ A
- Input Voltage Range 2.5 V to 5.5 V (Absolute Maximum Ratings: 6.5 V)
- Output Voltage Range^{*1}

| Version | Forced PWM Control | PWM/VFM Auto Switching Control |
|---------------------|--------------------|--------------------------------|
| RP506Kxx1A/B | 1.1 V to 3.3 V | 0.8 V to 3.3 V |
| RP506K001C | 1.1 V to 4.0 V | 0.8 V to 4.0 V |
| RP506Kxx1D/E | 0.6 V to 3.3 V | |
| RP506K001F | 0.6 V to 4.0 V | |

- Output Voltage Accuracy $\pm 1.5\%$ ($V_{SET}^{*2} \geq 1.2$ V),
..... ± 18 mV ($V_{SET} < 1.2$ V) (RP506Kxx1A/B/D/E)
- Feedback Voltage Accuracy ± 9 mV ($V_{FB} = 0.6$ V) (RP506K001C/F)
- Output Voltage/Feedback Voltage
Temperature Coefficient..... ± 100 ppm/ $^{\circ}$ C
- Oscillator Frequency..... Typ. 2.25 MHz (RP506Kxx1A/B/C)
..... Typ. 1.2 MHz (RP506Kxx1D/E/F)
- Oscillator Maximum Duty..... Min. 100%
- Built-in Driver ON Resistance..... Typ. Pch. 0.130 Ω , Nch. 0.125 Ω ($V_{IN} = 3.6$ V)
- UVLO Detector Threshold Typ. 2.2 V
- Inductor Current Limit Circuit..... Current limit Typ. 2.8 A
- Latch Type Protection Circuit..... Typ. 1.5 ms
- Package..... DFN(PLP)2527-10

^{*1} Refer to *Selection Guide* for detailed information. Fixed output voltage type (RP506Kxx1A/B/D/E) can be set by 0.1 V step.

^{*2} V_{SET} = Set Output Voltage

APPLICATION

- Power source for Li-ion battery-used equipment
- Power source for portable communication equipment, camcorder, DSC, Notebook PC
- Power source for HDD, WLAN

BLOCK DIAGRAM

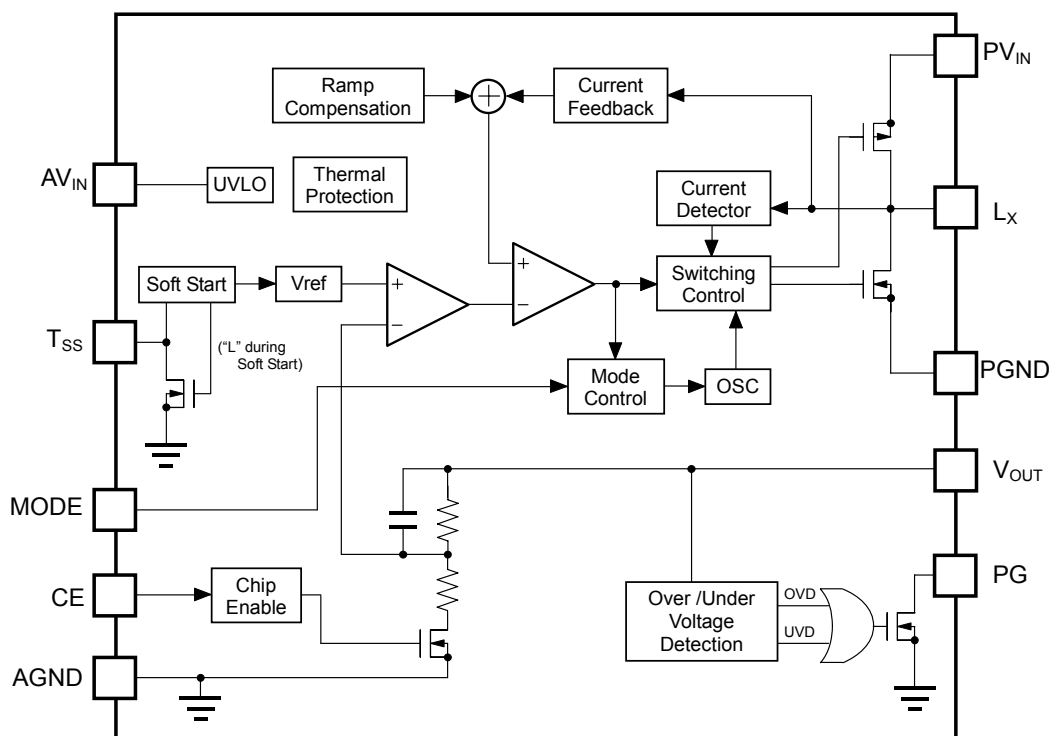

RP506Kxx1A/D

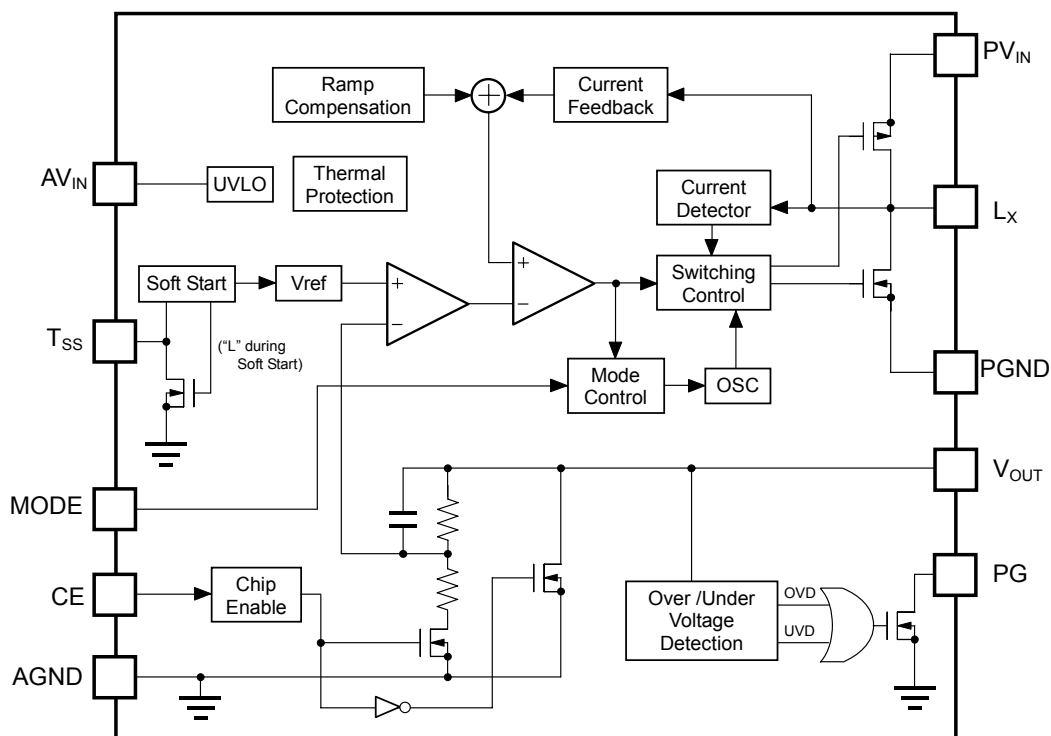

RP506Kxx1B/E

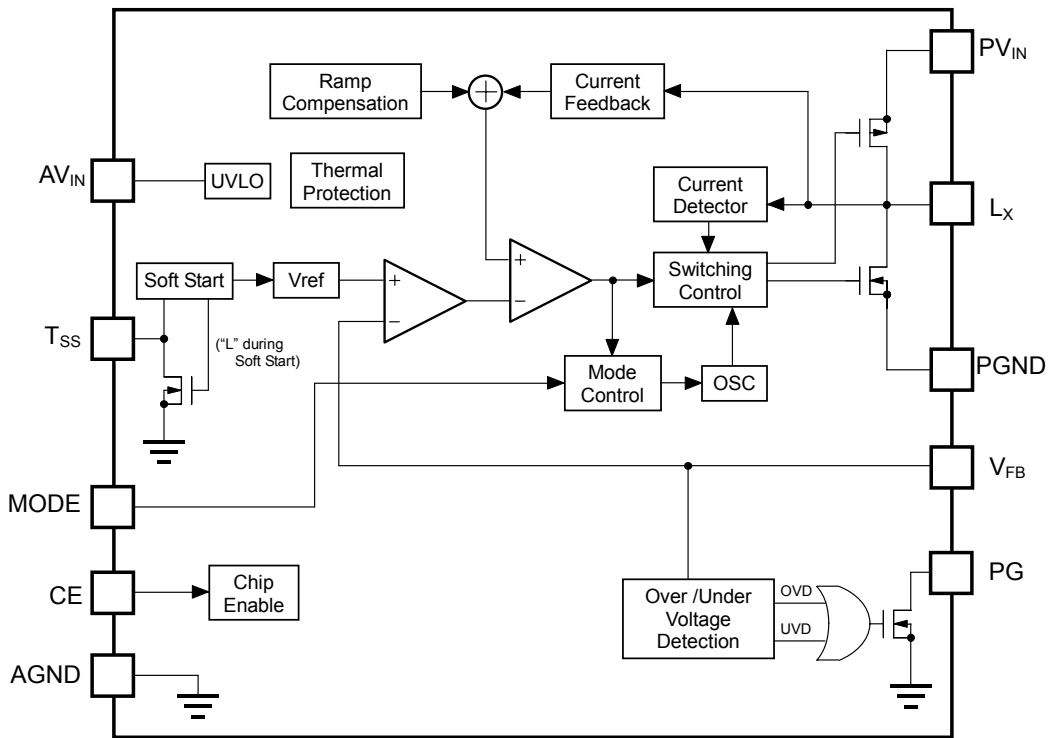

RP506K001C/F

SELECTION GUIDE

The set output voltage, the output voltage type, the auto-discharge function^{*1}, and the oscillator frequency for the ICs are user-selectable options.

Selection Guide

| Product Name | Package | Quantity per Reel | Pb Free | Halogen Free |
|-------------------|-----------------|-------------------|---------|--------------|
| RP506Kxx1\$(y)-TR | DFN(PLP)2527-10 | 5,000 pcs | Yes | Yes |

xx: Designation of the set output voltage (V_{SET}).
 For Fixed Output Voltage Type: 0.6 V (06)^{*2} to 3.3 V (33) in 0.1 V steps^{*3}
 For Adjustable Output Voltage Type: 001 only

(y): If V_{SET} includes the 3rd digit, indicate the digit of 0.01 V.
 (1.25 V)
 Ex. If V_{SET} is 1.25 V, RP506K121\$5-TR-FE.

\$: Designation of Version

| Version | Output Voltage Type | Auto-discharge Function | Oscillator Frequency | V_{SET} | |
|------------|---------------------|-------------------------|----------------------|----------------|------------------------|
| | | | | Forced PWM | PWM/VFM Auto Switching |
| RP506Kxx1A | Fixed | No | 2.25 MHz | 1.1 V to 3.3 V | 0.8 V to 3.3 V |
| RP506Kxx1B | | Yes | | | |
| RP506K001C | Adjustable | No | 1.2 MHz | 1.1 V to 4.0 V | 0.8 V to 4.0 V |
| RP506Kxx1D | Fixed | | | | |
| RP506Kxx1E | | Yes | 0.6 V to 3.3 V | | |
| RP506K001F | Adjustable | No | | 0.6 V to 4.0 V | |

^{*1} Auto-discharge function quickly lowers the output voltage to 0 V, when the chip enable signal is switched from the active mode to the standby mode, by releasing the electrical charge accumulated in the external capacitor.

^{*2} V_{SET} can be set only within the specified range of voltage. Refer to *Designation of Version* for detailed information.

^{*3} 0.05 V step is also available as a custom code.

PIN DESCRIPTION

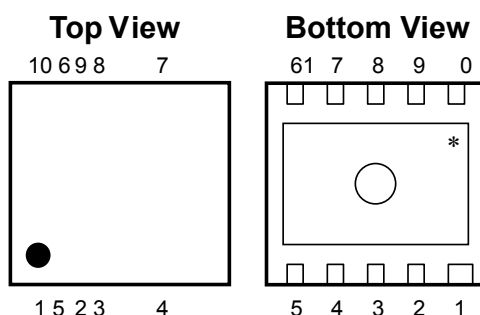

DFN(PLP)2527-10 Pin Configurations

DFN(PLP)2527-10 Pin Description

| Pin No. | Symbol | Description |
|---------|------------------|--|
| 1 | PV_{IN} | PV_{IN} Input Voltage Pin ^{*1} |
| 2 | AV_{IN} | AV_{IN} Input Voltage Pin ^{*1} |
| 3 | PG | Power Good Pin |
| 4 | CE | Chip Enable Pin (Active "H") |
| 5 | MODE | Mode Control Pin ("H": forced PWM control, "L": PWM/VFM auto switching control) |
| 6 | T_{SS} | Soft-start Pin |
| 7 | V_{OUT}/V_{FB} | Output/ Feedback Voltage Pin |
| 8 | AGND | Analog Ground Pin ^{*2} |
| 9 | L_X | Switching Pin |
| 10 | PGND | Power Ground Pin ^{*2} |

* The tab on the bottom of the package enhances thermal performance and is electrically connected to GND (substrate level). It is recommended that the tab be connected to the ground plane on the board, or otherwise be left floating.

^{*1} No.1 pin and No.2 pin must be wired to the V_{IN} plane when mounting on boards.

^{*2} No.8 pin and No.10 pin must be wired to the GND plane when mounting on boards.

ABSOLUTE MAXIMUM RATINGS

Absolute Maximum Ratings

(AGND=PGND=0V)

| Symbol | Item | Rating | Unit | | |
|------------------|-----------------------------------|---------------------------------|---------------------------|------|----|
| V_{IN} | A/PV _{IN} Pin Voltage | -0.3 to 6.5 | V | | |
| V_{LX} | L _X Pin Voltage | -0.3 to A/PV _{IN} +0.3 | V | | |
| V_{CE} | CE Pin Voltage | -0.3 to 6.5 | V | | |
| V_{OUT}/V_{FB} | V_{OUT}/V_{FB} Pin Voltage | -0.3 to 6.5 | V | | |
| V_{MODE} | MODE Pin Voltage | -0.3 to 6.5 | V | | |
| V_{PG} | PG Pin Voltage | -0.3 to 6.5 | V | | |
| V_{TSS} | T _{SS} Pin Voltage | -0.3 to AV _{IN} +0.3 | V | | |
| I_{LX} | L _X Pin Output Current | 2.8 | A | | |
| P_D | Power Dissipation ^{*1} | DFN(PLP)2527-10 | Standard Land Pattern | 910 | mW |
| | | | High Wattage Land Pattern | 1400 | mW |
| T_a | Operating Temperature Range | -40 to +85 | °C | | |
| T_{stg} | Storage Temperature Range | -55 to +125 | °C | | |

^{*1} Refer to *PACKAGE INFORMATION* for detailed information about Power Dissipation.

ABSOLUTE MAXIMUM RATINGS

Electronic and mechanical stress momentarily exceeded absolute maximum ratings may cause the permanent damages and may degrade the lifetime and safety for both device and system using the device in the field. The functional operation at or over these absolute maximum ratings is not assured.

RECOMMENDED OPERATING CONDITIONS (ELECTRICAL CHARACTERISTICS)

All of electronic equipment should be designed that the mounted semiconductor devices operate within the recommended operating conditions. The semiconductor devices cannot operate normally over the recommended operating conditions, even if when they are used over such conditions by momentary electronic noise or surge. And the semiconductor devices may receive serious damage when they continue to operate over the recommended operating conditions.

ELECTRICAL CHARACTERISTICS

RP506Kxx1 Electrical Characteristics

(Ta = 25°C)

| Symbol | Item | Conditions | Min. | Typ. | Max. | Unit |
|---|--|--|------|-------|------|------|
| Istandby | Standby Current | A/PV _{IN} = 5.5 V, V _{CE} = 0 V | | 0 | 5 | μA |
| I _{CEH} | CE "H" Input Current | A/PV _{IN} = V _{CE} = 5.5 V | -1 | 0 | 1 | μA |
| I _{CEL} | CE "L" Input Current | A/PV _{IN} = 5.5 V, V _{CE} = 0 V | -1 | 0 | 1 | μA |
| I _{MODEH} | MODE "H" Input Current | A/PV _{IN} = V _{MODE} = 5.5 V, V _{CE} = 0 V | -1 | 0 | 1 | μA |
| I _{MODEL} | MODE "L" Input Current | A/PV _{IN} = 5.5 V, V _{CE} = V _{MODE} = 0 V | -1 | 0 | 1 | μA |
| I _{LXLEAKH} | L _X Leakage Current "H" | A/PV _{IN} = V _{LX} = 5.5 V, V _{CE} = 0 V | -1 | 0 | 6 | μA |
| I _{LXLEAKL} | L _X Leakage Current "L" | A/PV _{IN} = 5.5 V, V _{CE} = V _{LX} = 0 V | -6 | 0 | 1 | μA |
| V _{CEH} | CE "H" Input Voltage | A/PV _{IN} = 5.5 V | 1.0 | | | V |
| V _{CEL} | CE "L" Input Voltage | A/PV _{IN} = 2.5 V | | | 0.4 | V |
| V _{MODEH} | MODE "H" Input Voltage | A/PV _{IN} = 5.5 V | 1.0 | | | V |
| V _{MODEL} | MODE "L" Input Voltage | A/PV _{IN} = 2.5 V | | | 0.4 | V |
| R _{ONP} | On Resistance of Pch Transistor | A/PV _{IN} = 3.6 V, I _{LX} = -100 mA | | 0.130 | | Ω |
| R _{ONN} | On Resistance of Nch Transistor | A/PV _{IN} = 3.6 V, I _{LX} = -100 mA | | 0.125 | | Ω |
| Maxduty | Maximum Duty Cycle | | 100 | | | % |
| tstart1 | Soft-start Time 1 | A/PV _{IN} = V _{CE} = 3.6 V or V _{SET} + 1 V, T _{SS} = OPEN | | 150 | 300 | μs |
| tstart2 | Soft-start Time 2 | A/PV _{IN} = V _{CE} = 3.6 V or V _{SET} + 1 V, C _{SS} = 0.1 μF | 15 | 30 | 45 | ms |
| I _{LXLIM} | L _X Current Limit | A/PV _{IN} = V _{CE} = 3.6 V or V _{SET} + 1 V | 2300 | 2800 | | mA |
| tprot | Protection Delay Time | A/PV _{IN} = V _{CE} = 3.6 V or V _{SET} + 1 V | 0.5 | 1.5 | 5 | ms |
| V _{UVLO1} | UVLO Detector Threshold | A/PV _{IN} = V _{CE} | 2.1 | 2.2 | 2.3 | V |
| V _{UVLO2} | UVLO Released Voltage | A/PV _{IN} = V _{CE} | 2.2 | 2.3 | 2.4 | V |
| T _{TSD} | Thermal Shutdown Temperature | Junction Temperature | | 150 | | °C |
| T _{TSR} | Thermal Shutdown Released Temperature | Junction Temperature | | 100 | | °C |
| R _{PG} | On Resistance of PG Pin When Low Output | A/PV _{IN} = 3.6 V, V _{OUT} = 0 V or V _{FB} = 0 V | | 45 | | Ω |
| ◆RP506Kxx1A/B, RP506K001C (Oscillator Frequency: 2.25MHz) Electrical Characteristics | | | | | | |
| V _{IN} | When MODE = H Operating Input Voltage* ¹ | 1.1 V ≤ V _{SET} < 1.2 V | 2.5 | | 4.5 | V |
| | | 1.2 V ≤ V _{SET} | 2.5 | | 5.5 | |
| | When MODE = L Operating Input Voltage* ² | 0.8 V ≤ V _{SET} < 1.0 V | 2.5 | | 4.5 | |
| | | 1.0 V ≤ V _{SET} | 2.5 | | 5.5 | |
| f _{OSC} | Oscillator Frequency | A/PV _{IN} = V _{CE} = 3.6 V or V _{SET} + 1 V | 2.00 | 2.25 | 2.50 | MHz |
| ◆RP506Kxx1D/E, RP506K001F (Oscillator Frequency: 1.2MHz) Electrical Characteristics | | | | | | |
| V _{IN} | When MODE = H Operating Input Voltage | 0.6 V ≤ V _{SET} < 0.7 V | 2.5 | | 4.5 | V |
| | | 0.7 V ≤ V _{SET} | 2.5 | | 5.5 | |
| | When MODE = L Operating Input Voltage | 0.6 V ≤ V _{SET} | 2.5 | | 5.5 | |
| f _{OSC} | Oscillator Frequency | A/PV _{IN} = V _{CE} = 3.6 V or V _{SET} + 1 V | 1.00 | 1.20 | 1.40 | MHz |

| Symbol | Item | Conditions | Min. | Typ. | Max. | Unit | |
|--|--|---|---------------------------|------------------------|-------|---------|----|
| ■RP506Kxx1A/B/D/E (Fixed Output Voltage Type) Electrical Characteristics | | | | | | | |
| V _{OUT} | Output Voltage | A/PV _{IN} = V _{CE} = 3.6 V or V _{SET} + 1 V | V _{SET} ≥ 1.2 V | x -1.015 | | x 1.015 | V |
| | | | V _{SET} < 1.2 V | -0.018 | | +0.018 | |
| ΔV _{OUT} /ΔTa | Output Voltage Temperature Coefficient | -40°C ≤ Ta ≤ 85°C | | ±100 | | ppm/°C | |
| I _{DD1} | Supply Current 1 | A/PV _{IN} = V _{CE} = 5.5 V, V _{OUT} = V _{SET} × 0.8 | | 600 | | μA | |
| I _{DD2} | Supply Current 2 | A/PV _{IN} = V _{CE} = V _{OUT} = 5.5 V | V _{MODE} = 0 V | | 48 | 72 | μA |
| | | | V _{MODE} = 5.5 V | | 600 | | μA |
| I _{VOU_TL} | V _{OUT} "L" Current | A/PV _{IN} = 5.5 V, V _{CE} = V _{OUT} = 0 V | -1 | 0 | 1 | μA | |
| V _{OVD} | OVD Voltage | A/PV _{IN} = 3.6 V | | V _{SET} × 1.2 | | V | |
| V _{UVD} | UVD Voltage | A/PV _{IN} = 3.6 V | | V _{SET} × 0.8 | | V | |
| □RP506Kxx1A/D (Fixed Output Voltage Type without Auto-discharge Function) | | | | | | | |
| I _{VOU_TH} | V _{OUT} "H" Current | A/PV _{IN} = V _{OUT} = 5.5 V, V _{CE} = 0 V | -1 | 0 | 1 | μA | |
| □RP506Kxx1B/E (Fixed Output Voltage Type with Auto-discharge Function) | | | | | | | |
| R _{LOW} | On Resistance of Low Output | A/PV _{IN} = 3.6 V, V _{CE} = 0 V | | 45 | | Ω | |
| ■RP506K001C/F (Adjustable Output Voltage Type) Electrical Characteristics | | | | | | | |
| V _{FB} | Feedback Voltage | A/PV _{IN} = V _{CE} = 3.6 V | 0.591 | 0.600 | 0.609 | V | |
| ΔV _{FB} /ΔTa | Feedback Voltage Temperature Coefficient | -40°C ≤ Ta ≤ 85°C | | ±100 | | ppm/°C | |
| I _{DD1} | Supply Current 1 | A/PV _{IN} = V _{CE} = 5.5 V, V _{FB} = 0.48 V | | 600 | | μA | |
| I _{DD2} | Supply Current 2 | A/PV _{IN} = V _{CE} = V _{FB} = 5.5 V | V _{MODE} = 0 V | | 48 | 72 | μA |
| | | | V _{MODE} = 5.5 V | | 600 | | μA |
| I _{VFBH} | V _{FB} "H" Current | A/PV _{IN} = V _{FB} = 5.5 V, V _{CE} = 0 V | -1 | 0 | 1 | μA | |
| I _{VFBL} | V _{FB} "L" Current | A/PV _{IN} = 5.5 V, V _{CE} = V _{FB} = 0 V | -1 | 0 | 1 | μA | |
| V _{OVD} | OVD Voltage | A/PV _{IN} = 3.6 V | | 0.72 | | V | |
| V _{UVD} | UVD Voltage | A/PV _{IN} = 3.6 V | | 0.48 | | V | |

All test items listed under *Electrical Characteristics* are done under the pulse load condition (T_J ≈ Ta = 25°C) except Output Voltage Temperature Coefficient and Feedback Voltage Temperature Coefficient.

^{*1} As for RP506Kxx1A/B/C (MODE = H), V_{SET} can be set from 1.1 V.

^{*2} As for RP506Kxx1A/B/C (MODE = L), V_{SET} can be set from 0.8 V.

TYPICAL APPLICATION

PG function is used, 30 ms Soft-start Time

*1 MODE = "H": forced PWM control, MODE = "L": PWM/VFM auto switching control

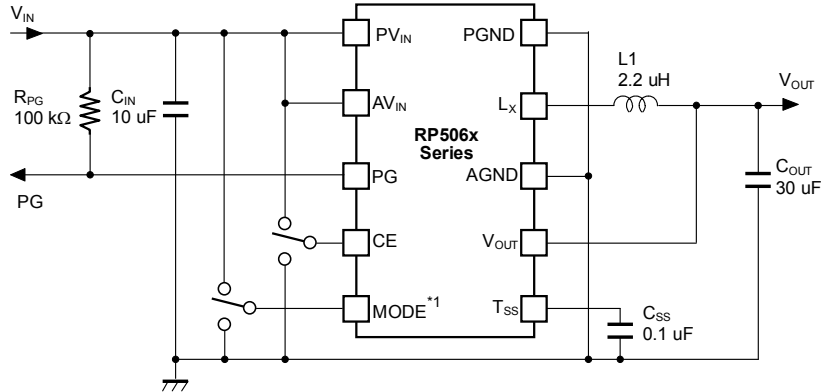

RP506Kxx1A/B/D/E (Fixed Output Voltage Type)

PG function is not used, 150 μs Soft-start Time

*1 MODE = "H": forced PWM control, MODE = "L": PWM/VFM auto switching control

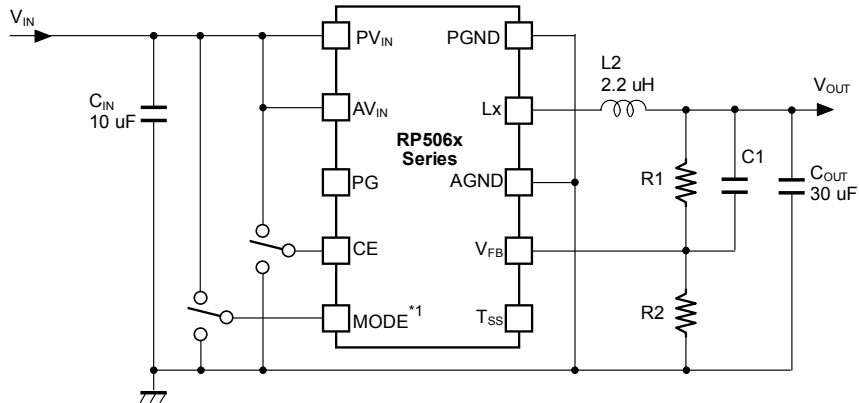

RP506K001C/F (Adjustable Output Voltage Type)

Recommended External Components

| Symbol | Size | Part Description | Model | | |
|---|-----------|-------------------|-----------------------------|-------------------|------------------------|
| C _{IN} | 10 μF | Ceramic Capacitor | C1608JB0J106M (TDK) | | |
| | | | JMK107BJ106MA (Taiyo Yuden) | | |
| C _{OUT} | 22 μF x 2 | Ceramic Capacitor | C2012JB0J226M (TDK) | | |
| | | | 10μF x 3 | Ceramic Capacitor | C1608JB0J106M (TDK) |
| | 4.7 μH | Inductor | | | SLF6045T-2R2N3R3 (TDK) |
| | | | CLF7045-2R2N (TDK) | | |
| L (V _{SET} ≤ 3.3V) | 2.2 μH | Inductor | FSD0415-2R2M (TOKO) | | |
| | | | RLF7030T-2R2M5R4 (TDK) | | |
| | | | 4.7 μH | Inductor | SLF6045T-4R7N2R4 (TDK) |
| | | | | | CLF7045-4R7N (TDK) |
| L (V _{SET} > 3.3V ^{*1}) | 4.7 μH | Inductor | FSD0415-4R7M (TOKO) | | |
| | | | RLF7030T-4R7M3R4 (TDK) | | |

^{*1} Only for RP506Kxx1C/F

Small and Low Profile External Components

| Symbol | Size | Part Description | Model |
|--------------------------------|--------|------------------|--------------------------|
| L (V _{SET} ≤ 1.5V) | 1.0 μH | Inductor | DFE252010R-H-1R0M (TOKO) |
| | | | VLS252010HBX-1R0M (TDK) |
| L (V _{SET} ≤ 2.3V) | 1.5 μH | Inductor | DFE252010R-H-1R5M (TOKO) |
| | | | VLS252010HBX-1R5M (TDK) |
| L | 2.2 μH | Inductor | DFE252010R-H-2R2M (TOKO) |
| | | | VLS252010HBX-2R2M (TDK) |

TECHNICAL NOTES

The performance of power source circuits using this IC largely depends on peripheral circuits. When selecting the peripheral components, please consider the conditions of use. Do not allow each component, PCB pattern or the IC to exceed their respected rated values (voltage, current, and power) when designing the peripheral circuits.

- AGND and PGND must be wired to the GND plane when mounting on boards.
- AV_{IN} and PV_{IN} must be wired to the V_{IN} plane when mounting on boards.
- Ensure the A/PV_{IN} and A/PGND lines are sufficiently robust. A large switching current flows through the A/PGND line, the V_{DD} line, the V_{OUT} line, an inductor, and L_X. If their impedance is too high, noise pickup or unstable operation may result. Set the external components as close as possible to the IC and minimize the wiring between the components and the IC. Especially, place a capacitor (C_{IN}) as close as possible to the PV_{IN} pin and PGND. For the RP506Kxx1A/B/D/E, separate the wiring between the V_{OUT} pin and an inductor (L1) from the wiring between L1 and Load. Likewise, for the RP506K001C/F, separate the wiring between a resistor for setting output voltage (R1) and an inductor (L2) from the wiring between L2 and Load.
- Choose a low ESR ceramic capacitor. The ceramic capacitance of C_{IN} should be more than or equal to 10 μF. For a ceramic capacitor (C_{OUT}), it is recommended that three paralleled 10 μF ceramic capacitors or two paralleled 22 μF ceramic capacitors be used.
- When V_{SET} ≤ 3.3 V, a 2.2 μH inductor is recommended for RP506Kxx1A/B/C/D/E/F. When V_{SET} ≤ 2.3 V, a 1.5 μH inductor can be used for RP506Kxx1A/B/C. When V_{SET} ≤ 1.5 V, a 1 μH inductor can be used for RP506Kxx1A/B/C. When V_{SET} > 3.3 V, a 4.7 μH inductor is recommended for RP506Kxx1C/F. The phase compensation of this IC is designed according to the C_{OUT} and L values. Choose an inductor that has small DC resistance, has enough allowable current and is hard to cause magnetic saturation. If the inductance value of an inductor is extremely small, the peak current of L_X may increase along with the load current. As a result, over current protection circuit may start to operate when the peak current of L_X reaches to “L_X limit current”.

Set Output Voltage Range vs. Inductance Range

| Version | RP506Kxx1A/B | | | RP506Kxx1D/E |
|---|--------------|------------|-------------|--------------|
| | L = 1.0 μH | L = 1.5 μH | L = 2.2 μH | L = 2.2 μH |
| Set Output Voltage V _{SET} (V) | | | | |
| up to 1.5 | Acceptable | Acceptable | Recommended | Recommended |
| 1.6 to 2.3 | - | Acceptable | Recommended | Recommended |
| 2.4 to 3.3 | - | - | Recommended | Recommended |

| Version | RP506Kxx1C | | | | RP506Kxx1F | |
|---|------------|------------|-------------|-------------|-------------|-------------|
| | L = 1.0 μH | L = 1.5 μH | L = 2.2 μH | L = 4.7 μH | L = 2.2 μH | L = 4.7 μH |
| Set Output Voltage V _{SET} (V) | | | | | | |
| up to 1.5 | Acceptable | Acceptable | Recommended | - | Recommended | - |
| 1.6 to 2.3 | - | Acceptable | Recommended | - | Recommended | - |
| 2.4 to 3.3 | - | - | Recommended | - | Recommended | - |
| 3.4 or more | - | - | - | Recommended | - | Recommended |

- Over current protection circuit and latch type protection circuit may be affected by self-heating or power dissipation environment.
- The output voltage (V_{SET}) is adjustable by changing the resistance values of resistors (R_1 , R_2) as follows.

$$V_{SET} = V_{FB} \times (R_1 + R_2) / R_2 \text{ (Recommended } V_{OUT} \text{ range for RP506K001F: } 0.6 \text{ V} \leq V_{SET} \leq 4.0 \text{ V)}$$

$$\text{(Recommended } V_{OUT} \text{ range for RP506K001C: } 0.8 \text{ V} \leq V_{SET} \leq 4.0 \text{ V)}$$

If R_1 and R_2 are too large, the impedances of V_{FB} also become large, as a result, the IC could be easily affected by noise. For this reason, R_2 should be 220 kΩ or less. If the operation becomes unstable due to the high impedances, the impedances should be decreased.

C_1 can be calculated by the following equations. Please use the value close to the calculation result.

$$C_1 = 4.84 \times 10^{-6} / R_2 \text{ [F]}$$

The recommended resistance values for R_1 and C_1 when $R_2 = 220 \text{ k}\Omega$ or $100 \text{ k}\Omega$ are as follows.

Set Output Voltage (V_{SET}) vs. Resistors (R_1 , R_2) and Capacitor (C_1)

| | | | | | | | | | |
|---------------|-----|------|------|-----|-----|-----|-----|-----|-----|
| V_{SET} [V] | 0.6 | 0.7 | 0.8 | 1.2 | 1.8 | 2.5 | 3.3 | 3.8 | 4.0 |
| R_1 [kΩ] | 0 | 36.7 | 73.3 | 220 | 440 | 697 | 990 | 533 | 567 |
| R_2 [kΩ] | 220 | 220 | 220 | 220 | 220 | 220 | 220 | 100 | 100 |
| C_1 [pF] | - | 22 | 22 | 22 | 22 | 22 | 22 | 15 | 15 |

- Soft-start Time (t_{start}) is adjustable by connecting a capacitor (C_{SS}) between the T_{SS} pin and GND. The capacitance value for C_{SS} that is suitable for t_{start} can be calculated by the following equation.

$$C_{SS} \text{ (nF)} = 3.5 \times t_{start} \text{ (ms)}$$

The T_{SS} pin must be open if Soft-start time function is not used. Soft-start time is set to typically 150 μs when the T_{SS} pin is open.

- When using the power good function, the resistance value of a resistor (R_{PG}) should be between 10 kΩ to 100 kΩ. The PG pin must be open or connected to GND if the power good function is not used.

SOFT START TIME ADJUSTMENT FUNCTION AND POWER GOOD FUNCTION

Soft-start Time Adjustment Function

Soft-start time (t_{start}) of the RP506x is adjustable by connecting a soft-start time adjustment capacitor (C_{SS}) between the T_{SS} pin and GND. t_{start} can be set from Typ. 0.15 ms. As Figure 6 shows, if 0.1 μ F C_{SS} is connected, t_{start} will be 30 ms. The T_{SS} pin must be open if the soft-start time function is not used. t_{start} is set to 0.15 ms (Typ.) when the T_{SS} pin is open.

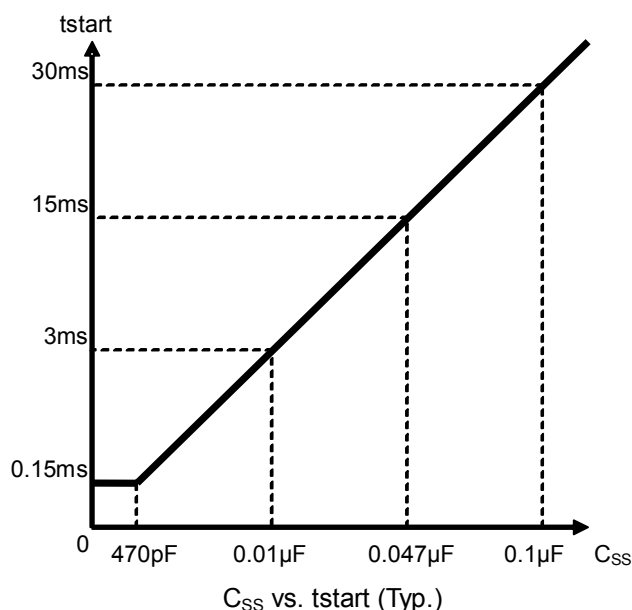

Soft-start Time (t_{start}) vs. Soft-start Time Adjustment Capacitor (C_{SS})

Power Good Function

The RP506x contains a power good function using Nch open drain. If any abnormal condition is detected, the power good function turns Nch transistor on and switches the PG pin to low. If the cause of the abnormal condition is removed, the power good function turns Nch transistor off and switches the PG pin back to high. After the recovery from abnormal condition, it takes typically 0.1 ms for the IC to turn Nch transistor off. The followings are the abnormal conditions that the power good function can detect.

- CE = "L" (Shut down)
- UVLO (Shut down)
- Thermal Shutdown
- Over Voltage Detection: Typ. $V_{SET} \times 1.2$ V (RP506Kxx1A/B/D/E) or 0.72 V (RP506Kxx1C/F)
- Under Voltage Detection: Typ. $V_{SET} \times 0.8$ V (RP506Kxx1A/B/D/E) or 0.48 V (RP506Kxx1C/F)

When using the power good function, the resistance of PG pin (R_{PG}) should be between 10 k Ω to 100 k Ω . The PG pin must be open or connected to GND if the power good function is not used.

SEQUENTIAL START-UP USING SOFT-START TIME ADJUSTMENT FUNCTION AND POWER GOOD FUNCTION

Sequential startup circuits can be built by using soft-start time adjustment function and power good function of the RP506x.

Figure 7 is an example of sequential startup circuits using DC/DC1 and DC/DC2. By sending a PG signal to the CE pin of DC/DC2, DC/DC1 starts up first followed by DC/DC2.

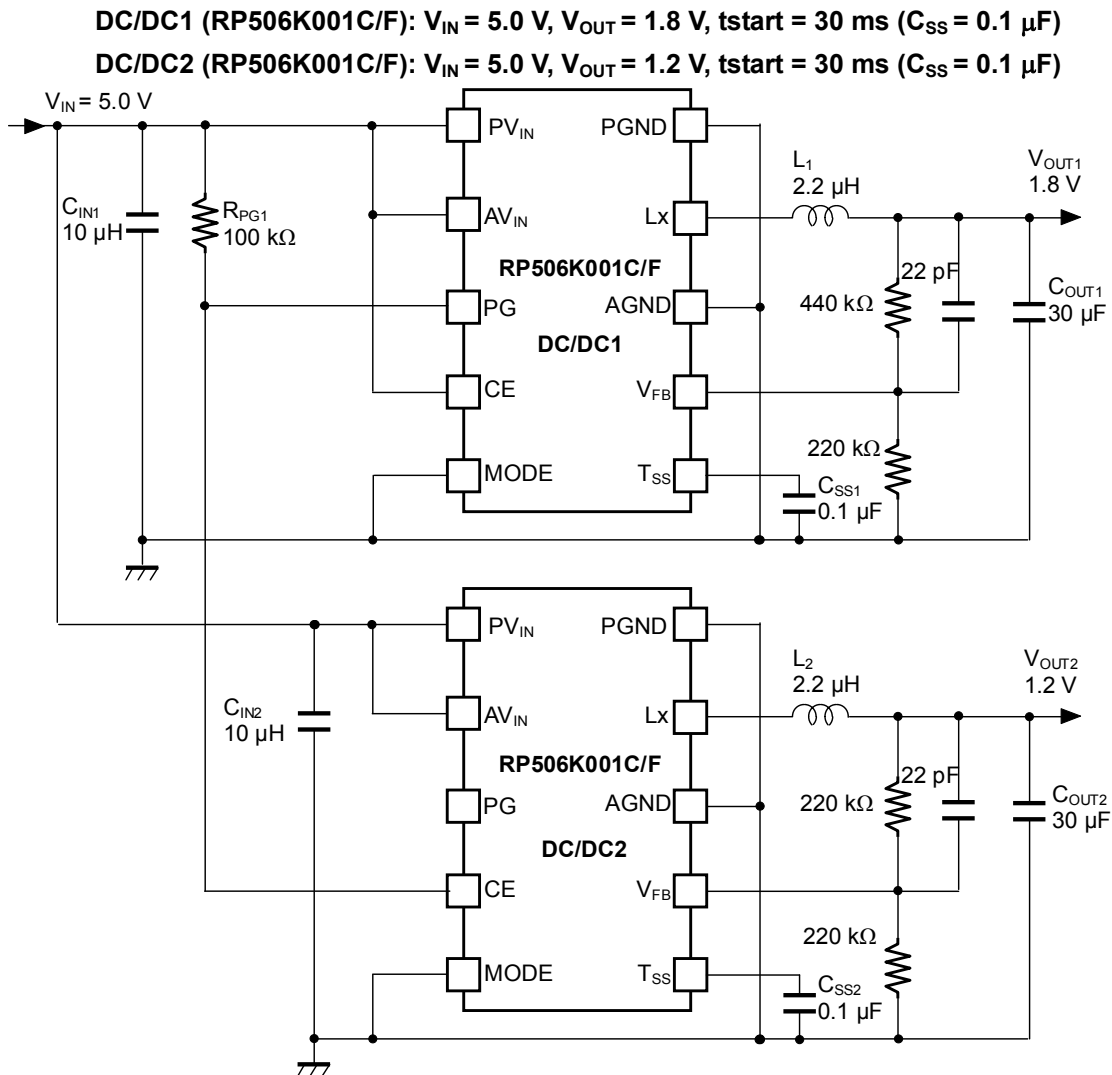

Circuits Example using Sequential Startup

OPERATION OF STEP-DOWN DC/DC CONVERTER AND OUTPUT CURRENT

The step-down DC/DC converter charges energy in the inductor when L_x Tr. turns "ON", and discharges the energy from the inductor when L_x Tr. turns "OFF" and controls with less energy loss, so that a lower output voltage (V_{OUT}) than the input voltage (V_{IN}) can be obtained. The operation of the step-down DC/DC converter is explained in the following figures.

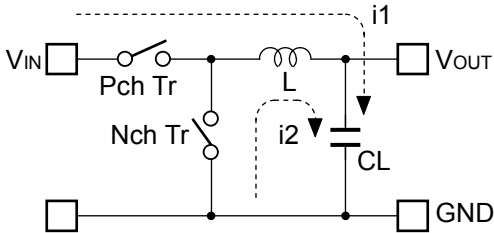

Basic Circuit

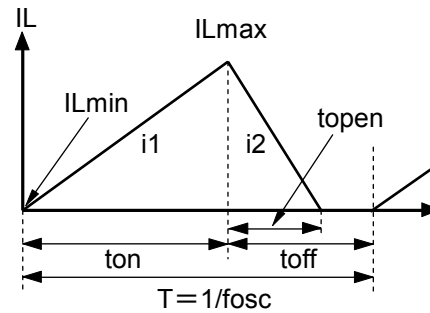

Inductor Current (I_L) flowing through Inductor (L)

- Step1.** Pch Tr. turns "ON" and I_L (i_1) flows, L is charged with energy. At this moment, i_1 increases from the minimum inductor current (I_{Lmin}), which is 0 A, and reaches the maximum inductor current (I_{Lmax}) in proportion to the on-time period (t_{on}) of Pch Tr.
- Step2.** When Pch Tr. turns "OFF", L tries to maintain I_L at I_{Lmax} , so L turns Nch Tr. "ON" and I_L (i_2) flows into L .
- Step3.** i_2 decreases gradually and reaches I_{Lmin} after the open-time period (t_{open}) of Nch Tr., and then Nch Tr. turns "OFF". This is called discontinuous current mode.

As the output current (I_{OUT}) increases, the off-time period (t_{off}) of Pch Tr. runs out before I_L reaches I_{Lmin} . The next cycle starts, and Pch Tr. turns "ON" and Nch Tr. turns "OFF", which means I_L starts increasing from I_{Lmin} . This is called continuous current mode.

In the case of PWM mode, V_{OUT} is maintained by controlling t_{on} . During PWM mode, the oscillator frequency (f_{osc}) is being maintained constant.

As shown in Figure 9, when the step-down DC/DC operation is constant, I_{Lmin} and I_{Lmax} during t_{on} of Pch Tr. would be same as during t_{off} of Pch Tr.

The current differential between I_{Lmax} and I_{Lmin} is described as ΔI .

$$\Delta I = I_{Lmax} - I_{Lmin} = V_{OUT} \times t_{open} / L = (V_{IN} - V_{OUT}) \times t_{on} / L \dots\dots\dots \text{Equation 1}$$

However,

$$T = 1 / f_{osc} = t_{on} + t_{off}$$

$$\text{duty (\%)} = t_{on} / T \times 100 = t_{on} \times f_{osc} \times 100$$

$$t_{open} \leq t_{off}$$

In Equation 1, " $V_{OUT} \times t_{open} / L$ " shows the amount of current change in "ON" state. Also, " $(V_{IN} - V_{OUT}) \times t_{on} / L$ " shows the amount of current change at "OFF" state.

Discontinuous Mode and Continuous Mode

As illustrated in Figure 1, when I_{OUT} is relatively small, $t_{open} < t_{off}$. In this case, the energy charged into L during t_{on} will be completely discharged during t_{off} , as a result, $I_{Lmin} = 0$. This is called discontinuous mode.

When I_{OUT} is gradually increased, eventually $t_{open} = t_{off}$ and when I_{OUT} is increased further, eventually $I_{Lmin} > 0$, as illustrated in Figure 2. This is called continuous mode.

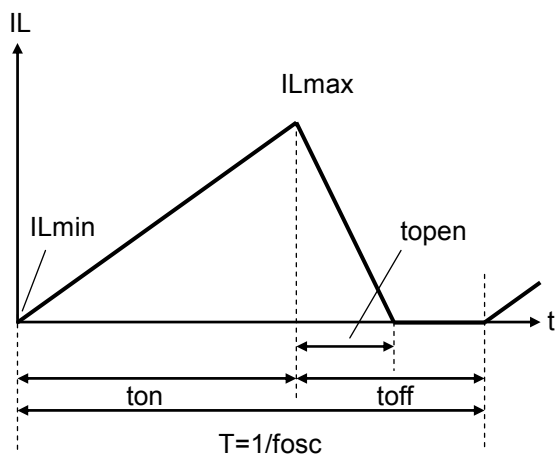

Figure 1. Discontinuous Mode

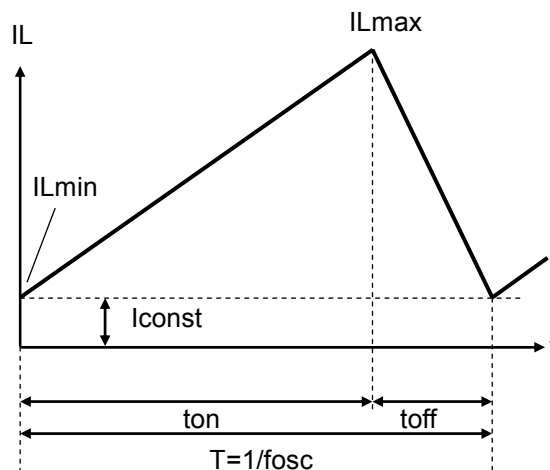

Figure 2. Continuous Mode

In the continuous mode, the solution of Equation 1 is described as t_{onc} .

$$t_{onc} = T_a \times V_{OUT} / V_{IN} \dots\dots\dots \text{Equation 2}$$

When $t_{on} < t_{onc}$, it is discontinuous mode, and when $t_{on} = t_{onc}$, it is continuous mode.

Forced PWM Mode

By setting the MODE pin to “H”, the IC switches the frequency at the fixed rate to reduce noise even when the output load is light. Therefore, when I_{OUT} is $\Delta IL/2$ or less, IL_{min} becomes less than 0. That is, the accumulated electricity in CL is discharged through the IC side while IL is increasing from IL_{min} to 0 during ton , and also while IL is decreasing from 0 to IL_{min} during $toff$.

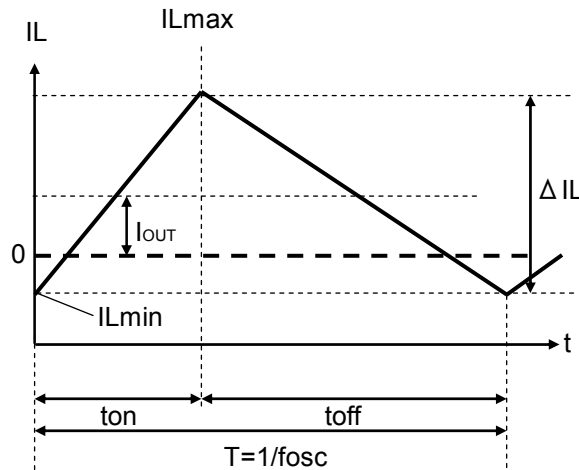

Forced PWM Mode

VFM Mode

By setting the MODE pin to “L”, in low output current, the IC automatically switches into VFM mode in order to achieve high efficiency. In VFM mode, ton is forced to end when the inductor current reaches the pre-set IL_{max} . In the VFM mode, IL_{max} is typically set to 400 mA for the RP506Kxx1A/B/C, and 550 mA for the RP506Kxx1D/E/F. When ton reaches 1.5 times of $T = 1 / f_{osc}$, ton will be forced to end even if the inductor current is not reached IL_{max} .

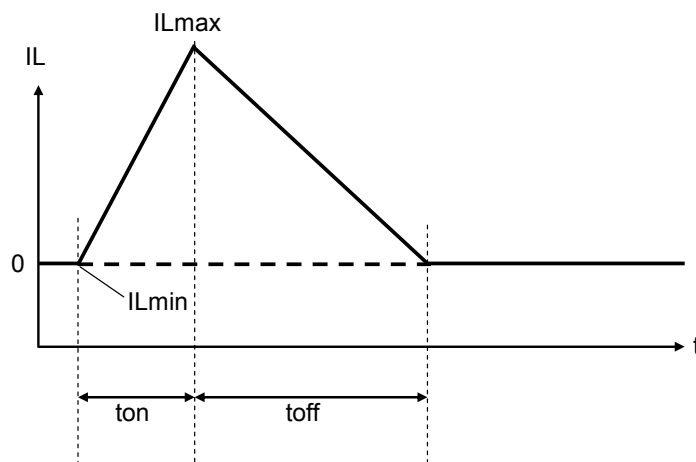

VFM Mode

OUTPUT CURRENT AND SELECTION OF EXTERNAL COMPONENTS

The following equations explain the relationship between output current and peripheral components that are listed in *Table 1. Recommended External Components*.

Ripple Current P-P value is described as I_{RP} , ON resistance of Pch Tr. is described as R_{ONP} , ON resistance of Nch Tr. is described as R_{ONN} , and DC resistor of the inductor is described as R_L .

First, when Pch Tr. is "ON", the following equation is satisfied.

$$V_{IN} = V_{OUT} + (R_{ONP} + R_L) \times I_{OUT} + L \times I_{RP} / ton \dots\dots\dots \text{Equation 3}$$

Second, when Pch Tr. is "OFF" (Nch Tr. is "ON"), the following equation is satisfied.

$$L \times I_{RP} / toff = R_{ONN} \times I_{OUT} + V_{OUT} + R_L \times I_{OUT} \dots\dots\dots \text{Equation 4}$$

Put Equation 4 into Equation 3 to solve ON duty of Pch Tr. ($D_{ON} = ton / (toff + ton)$):

$$D_{ON} = (V_{OUT} + R_{ONN} \times I_{OUT} + R_L \times I_{OUT}) / (V_{IN} + R_{ONN} \times I_{OUT} - R_{ONP} \times I_{OUT}) \dots\dots\dots \text{Equation 5}$$

Ripple Current is described as follows:

$$I_{RP} = (V_{IN} - V_{OUT} - R_{ONP} \times I_{OUT} - R_L \times I_{OUT}) \times D_{ON} / fosc / L \dots\dots\dots \text{Equation 6}$$

Peak current that flows through L, and L_X Tr. is described as follows:

$$I_{LXmax} = I_{OUT} + I_{RP} / 2 \dots\dots\dots \text{Equation 7}$$

- ★ Please consider I_{LXmax} when setting conditions of input and output, as well as selecting the external components.
- ★ The above calculation formulas are based on the ideal operation of the ICs in continuous mode.

TIMING CHART

(1) Soft-start Time

Starting-up with CE Pin

The IC starts to operate when the CE pin voltage (V_{CE}) exceeds the threshold voltage. The threshold voltage is preset between CE "H" input voltage (V_{CEH}) and CE "L" input voltage (V_{CEL}).

After the start-of the start-up of the IC, soft-start circuit starts to operate. Then, after a certain period of time, the reference voltage (V_{REF}) in the IC gradually increases up to the specified value.

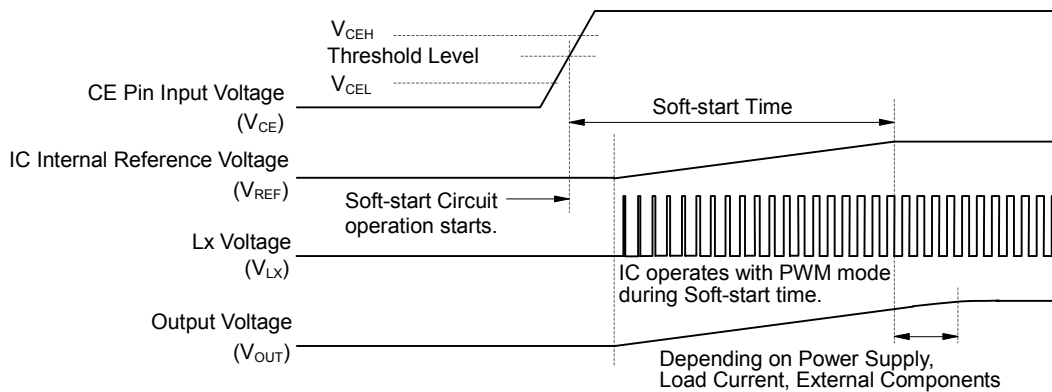

Timing Chart

Soft-start time starts when soft-start circuit is activated, and ends when the reference voltage reaches the specified voltage.

- ★ Soft start time is not always equal to the turn-on speed of the step-down DC/DC converter. Please note that the turn-on speed could be affected by the power supply capacity, the output current, the inductance value and the C_{OUT} value.

Starting-up with Power Supply

After the power-on, when V_{IN} exceeds the UVLO released voltage (V_{UVLO2}), the IC starts to operate. Then, soft-start circuit starts to operate and after a certain period of time, V_{REF} gradually increases up to the specified value. Soft-start time starts when soft-start circuit is activated, and ends when V_{REF} reaches the specified voltage.

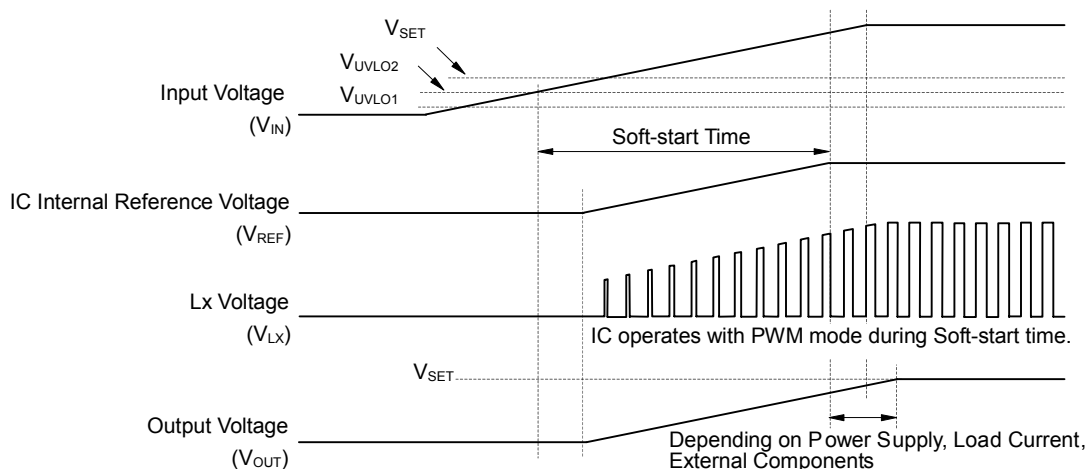

Timing Chart

- ★ Please note that the turn-on speed of V_{OUT} could be affected by the power supply capacity, the output current, the inductance value, the C_{OUT} value and the turn-on speed of V_{IN} determined by C_{IN} .

(2) Under Voltage Lockout (UVLO) Circuit

If V_{IN} becomes lower than V_{SET} , the step-down DC/DC converter stops the switching operation and ON duty becomes 100%, and then V_{OUT} gradually drops according to V_{IN} .

If the V_{IN} drops more and becomes lower than the UVLO detector threshold (V_{UVLO1}), the UVLO circuit starts to operate, V_{REF} stops, and Pch and Nch built-in switch transistors turn “OFF”. As a result, V_{OUT} drops according to the C_{OUT} capacitance value and the load.

To restart the operation, V_{IN} needs to be higher than V_{UVLO2} . The timing chart below shows the voltage shifts of V_{REF} , V_{LX} and V_{OUT} when V_{IN} value is varied.

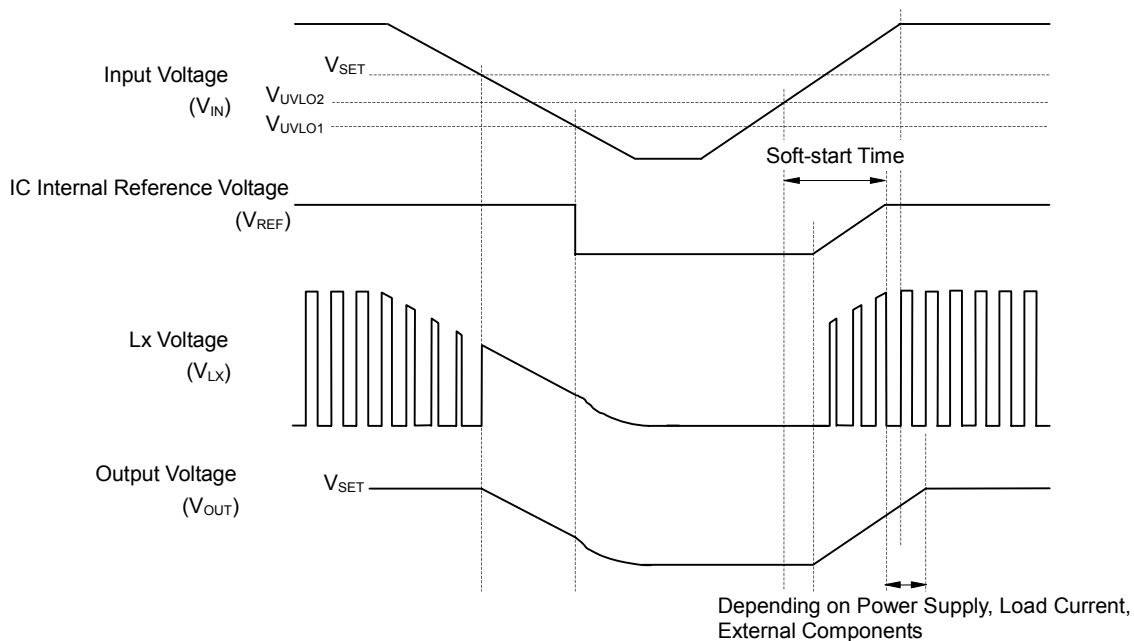

Timing Chart

★ Falling edge (operating) and rising edge (releasing) waveforms of V_{OUT} could be affected by the initial voltage of C_{OUT} and the output current of V_{OUT} .

(3) Over Current Protection Circuit, Latch Type Protection Circuit

Over current protection circuit supervises the inductor peak current (the peak current flowing through Pch Tr.) in each switching cycle, and if the current exceeds the I_{LXLIM} current limit (I_{LXLIM}), it turns off Pch Tr. I_{LXLIM} of the RP506x is set to Typ.2800 mA.

Latch type protection circuit latches the built-in driver to the OFF state and stops the operation of the step-down DC/DC converter if the over current status continues or V_{OUT} continues being the half of the setting voltage for equal or longer than protection delay time (t_{prot}).

Notes: I_{LXLIM} and t_{prot} could be easily affected by self-heating or ambient environment. If the V_{IN} drops dramatically or becomes unstable due to short-circuit, protection operation and t_{prot} could be affected.

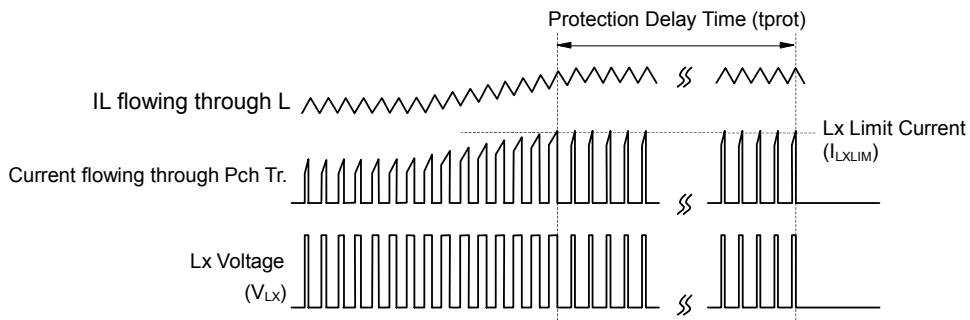

Protection Delay Time

To release the latch type protection circuit, restart the IC by inputting "L" signal to the CE pin, or restart the IC with power-on or make the supply voltage lower than V_{UVLO1} .

The timing chart below shows the voltage shift of V_{CE} , V_{LX} and V_{OUT} when the IC status is changed by the following orders: V_{IN} rising → stable operation → high load → CE reset → stable operation → V_{IN} falling → V_{IN} recovering (UVLO reset) → stable operation.

- (1)(2) If the large current flows through the circuit or the IC goes into low V_{OUT} condition due to short-circuit or other reasons, the latch type protection circuit latches the built-in driver to "OFF" state after t_{prot} . Then, V_{LX} becomes "L" and V_{OUT} turns "OFF".
- (3) The latch type protection circuit is released by CE reset, which puts the IC into "L" once with the CE pin and back into "H".
- (4) The latch type protection circuit is released by UVLO reset, which makes V_{IN} lower than V_{UVLO1} .

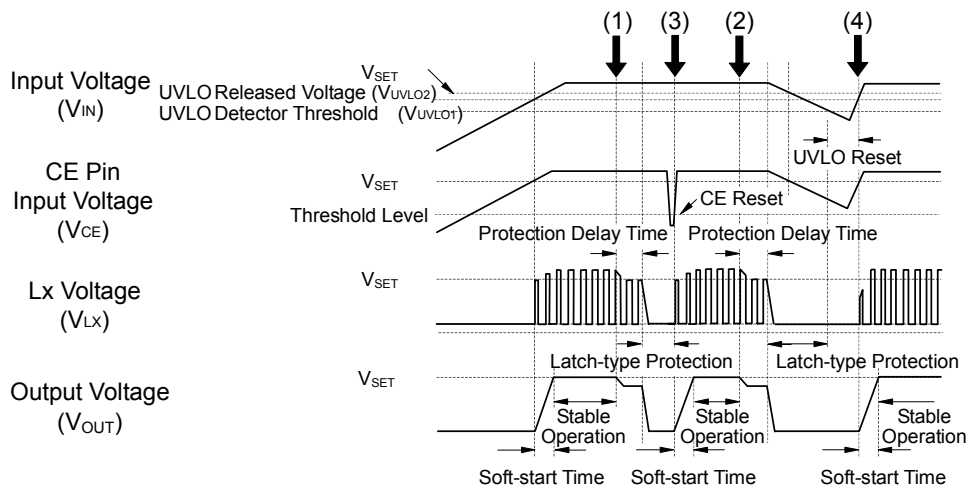

Timing Chart

PACKAGE INFORMATION

POWER DISSIPATION (DFN(PLP)2527-10)

Power Dissipation (P_D) of the package is dependent on PCB material, layout, and environmental conditions. The following conditions are used in this measurement.

Measurement Conditions

| | High Wattage Land Pattern | Standard Land Pattern |
|------------------|---|--|
| Environment | Mounting on Board (Wind Velocity = 0 m/s) | Mounting on Board (Wind Velocity = 0 m/s) |
| Board Material | Glass Cloth Epoxy Plastic (4-Layers) | Glass Cloth Epoxy Plastic (Double-sided) |
| Board Dimensions | 35 mm x 90 mm x 0.8 mm | 40 mm x 40 mm x 1.6 mm |
| Copper Ratio | Each layers: Approx. 15% | Top side: Approx. 50%, Back side: Approx. 50% |
| Through-holes | ϕ 0.30 mm x 9 pcs ϕ 0.50 mm x 10 pcs | ϕ 0.54 mm x 30 pcs |

Measurement Result

($T_a = 25^\circ\text{C}$, $T_{j\text{max}} = 125^\circ\text{C}$)

| | High Wattage Land Pattern | Standard Land Pattern |
|--------------------|---|---|
| Power Dissipation | 1400 mW ($T_{j\text{max}} = 125^\circ\text{C}$) | 910 mW ($T_{j\text{max}} = 125^\circ\text{C}$) |
| Thermal Resistance | $\theta_{ja} = (125 - 25^\circ\text{C}) / 1.4\text{W} = 71^\circ\text{C/W}$ | $\theta_{ja} = (125 - 25^\circ\text{C}) / 0.91\text{W} = 110^\circ\text{C/W}$ |

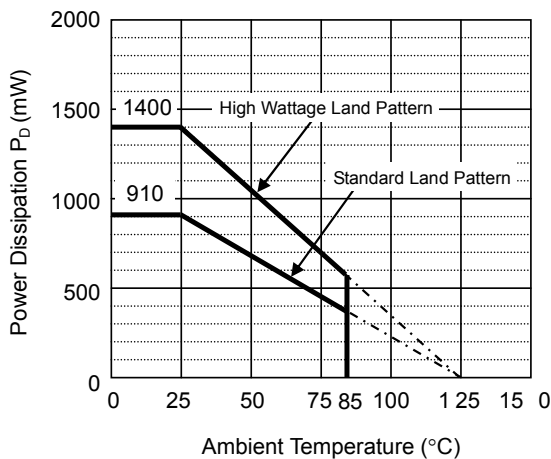

Power Dissipation vs. Ambient Temperature

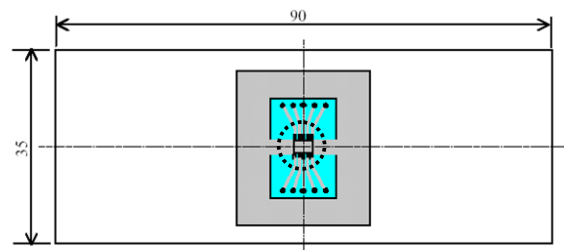

High Wattage Land Pattern

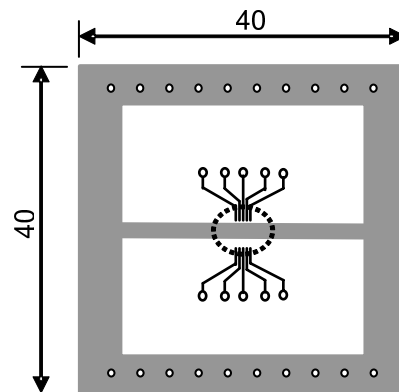

Standard Land Pattern

○ IC Mount Area (Unit: mm)

Measurement Board Pattern

PACKAGE DIMENSIONS (DFN(PLP)2527-10)

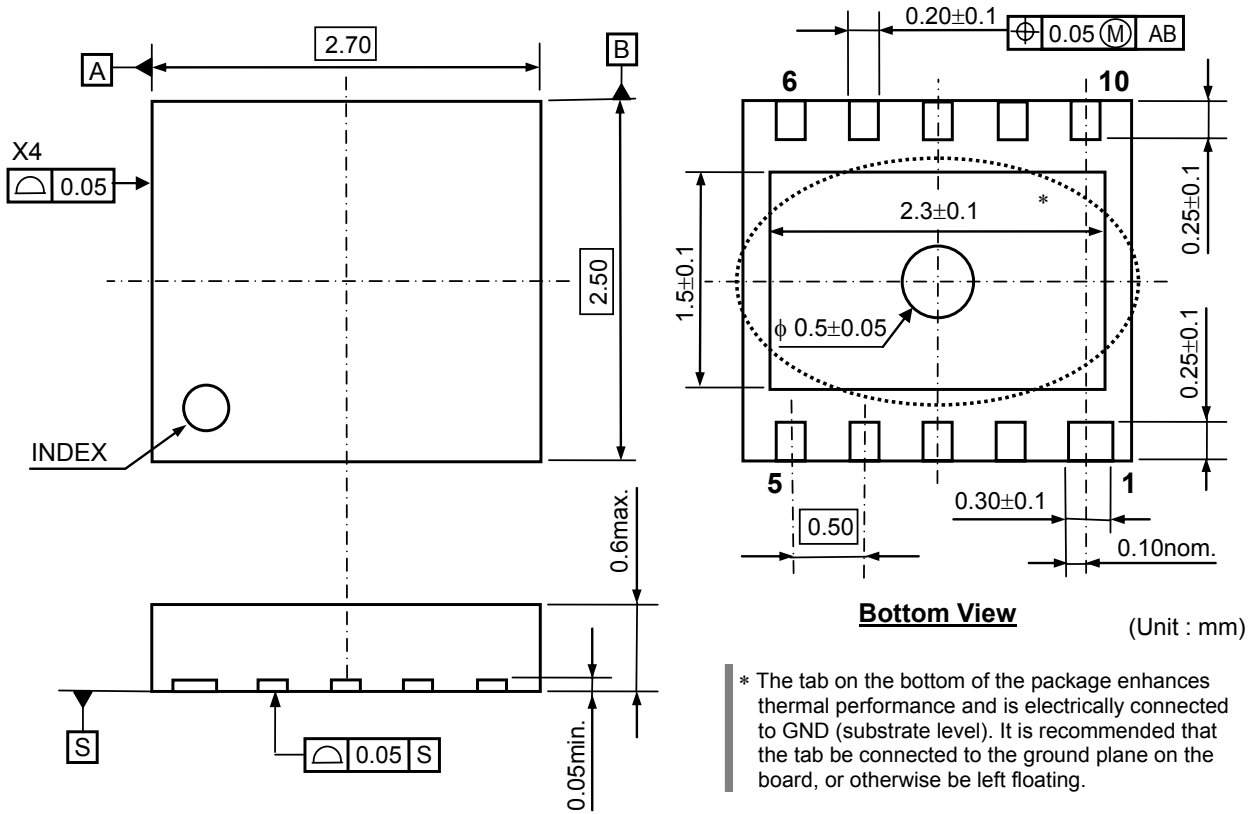

DFN (PLP) 2527-10 Package Dimensions

MARK SPECIFICATION (DFN(PLP)2527-10)

- ①②③④: Product Code ... **Refer to MARK SPECIFICATION TABLE (DFN(PLP)2527-10)**
- ⑤⑥: Lot Number ... Alphanumeric Serial Number

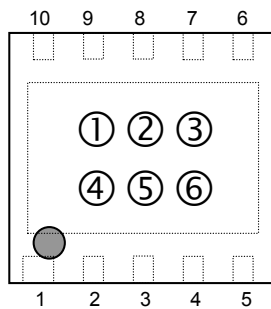

DFN (PLP) 2527-10 Mark Specification

MARK SPECIFICATION TABLE (DFN (PLP) 2527-10)

| Product Name | ① | ② | ③ | ④ | Product Name | ① | ② | ③ | ④ |
|--------------|---|---|---|---|--------------|---|---|---|---|
| RP506K081A | D | 0 | 8 | A | RP506K061D | D | 0 | 6 | D |
| RP506K091A | D | 0 | 9 | A | RP506K071D | D | 0 | 7 | D |
| RP506K101A | D | 1 | 0 | A | RP506K081D | D | 0 | 8 | D |
| RP506K111A | D | 1 | 1 | A | RP506K091D | D | 0 | 9 | D |
| RP506K121A | D | 1 | 2 | A | RP506K101D | D | 1 | 0 | D |
| RP506K131A | D | 1 | 3 | A | RP506K111D | D | 1 | 1 | D |
| RP506K141A | D | 1 | 4 | A | RP506K121D | D | 1 | 2 | D |
| RP506K151A | D | 1 | 5 | A | RP506K131D | D | 1 | 3 | D |
| RP506K161A | D | 1 | 6 | A | RP506K141D | D | 1 | 4 | D |
| RP506K171A | D | 1 | 7 | A | RP506K151D | D | 1 | 5 | D |
| RP506K181A | D | 1 | 8 | A | RP506K161D | D | 1 | 6 | D |
| RP506K191A | D | 1 | 9 | A | RP506K171D | D | 1 | 7 | D |
| RP506K201A | D | 2 | 0 | A | RP506K181D | D | 1 | 8 | D |
| RP506K211A | D | 2 | 1 | A | RP506K191D | D | 1 | 9 | D |
| RP506K221A | D | 2 | 2 | A | RP506K201D | D | 2 | 0 | D |
| RP506K231A | D | 2 | 3 | A | RP506K211D | D | 2 | 1 | D |
| RP506K241A | D | 2 | 4 | A | RP506K221D | D | 2 | 2 | D |
| RP506K251A | D | 2 | 5 | A | RP506K231D | D | 2 | 3 | D |
| RP506K261A | D | 2 | 6 | A | RP506K241D | D | 2 | 4 | D |
| RP506K271A | D | 2 | 7 | A | RP506K251D | D | 2 | 5 | D |
| RP506K281A | D | 2 | 8 | A | RP506K261D | D | 2 | 6 | D |
| RP506K291A | D | 2 | 9 | A | RP506K271D | D | 2 | 7 | D |
| RP506K301A | D | 3 | 0 | A | RP506K281D | D | 2 | 8 | D |
| RP506K311A | D | 3 | 1 | A | RP506K291D | D | 2 | 9 | D |
| RP506K321A | D | 3 | 2 | A | RP506K301D | D | 3 | 0 | D |
| RP506K331A | D | 3 | 3 | A | RP506K311D | D | 3 | 1 | D |
| RP506K121A5 | D | 0 | 0 | A | RP506K321D | D | 3 | 2 | D |
| RP506K081B | D | 0 | 8 | B | RP506K331D | D | 3 | 3 | D |
| RP506K091B | D | 0 | 9 | B | RP506K121D5 | D | 0 | 0 | D |
| RP506K101B | D | 1 | 0 | B | RP506K061E | D | 0 | 6 | E |
| RP506K111B | D | 1 | 1 | B | RP506K071E | D | 0 | 7 | E |
| RP506K121B | D | 1 | 2 | B | RP506K081E | D | 0 | 8 | E |
| RP506K131B | D | 1 | 3 | B | RP506K091E | D | 0 | 9 | E |
| RP506K141B | D | 1 | 4 | B | RP506K101E | D | 1 | 0 | E |
| RP506K151B | D | 1 | 5 | B | RP506K111E | D | 1 | 1 | E |
| RP506K161B | D | 1 | 6 | B | RP506K121E | D | 1 | 2 | E |
| RP506K171B | D | 1 | 7 | B | RP506K131E | D | 1 | 3 | E |
| RP506K181B | D | 1 | 8 | B | RP506K141E | D | 1 | 4 | E |
| RP506K191B | D | 1 | 9 | B | RP506K151E | D | 1 | 5 | E |
| RP506K201B | D | 2 | 0 | B | RP506K161E | D | 1 | 6 | E |
| RP506K211B | D | 2 | 1 | B | RP506K171E | D | 1 | 7 | E |
| RP506K221B | D | 2 | 2 | B | RP506K181E | D | 1 | 8 | E |
| RP506K231B | D | 2 | 3 | B | RP506K191E | D | 1 | 9 | E |
| RP506K241B | D | 2 | 4 | B | RP506K201E | D | 2 | 0 | E |
| RP506K251B | D | 2 | 5 | B | RP506K211E | D | 2 | 1 | E |
| RP506K261B | D | 2 | 6 | B | RP506K221E | D | 2 | 2 | E |
| RP506K271B | D | 2 | 7 | B | RP506K231E | D | 2 | 3 | E |
| RP506K281B | D | 2 | 8 | B | RP506K241E | D | 2 | 4 | E |
| RP506K291B | D | 2 | 9 | B | RP506K251E | D | 2 | 5 | E |
| RP506K301B | D | 3 | 0 | B | RP506K261E | D | 2 | 6 | E |
| RP506K311B | D | 3 | 1 | B | RP506K271E | D | 2 | 7 | E |
| RP506K321B | D | 3 | 2 | B | RP506K281E | D | 2 | 8 | E |
| RP506K331B | D | 3 | 3 | B | RP506K291E | D | 2 | 9 | E |
| RP506K121B5 | D | 0 | 0 | B | RP506K301E | D | 3 | 0 | E |
| RP506K001C | D | 0 | 0 | C | RP506K311E | D | 3 | 1 | E |
| | | | | | RP506K321E | D | 3 | 2 | E |
| | | | | | RP506K331E | D | 3 | 3 | E |
| | | | | | RP506K121E5 | D | 0 | 0 | E |
| | | | | | RP506K001F | D | 0 | 0 | F |

TYPICAL PERFORMANCE CHARACTERISTICS

1) Output Voltage vs. Output Current

RP506 Kxx1A/B/C $V_{OUT} = 1.2\text{ V}$
MODE = "L" PWM/VFM Auto Switching Control

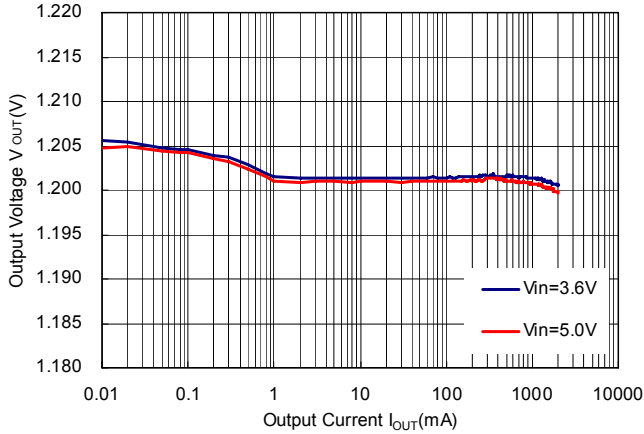

RP506Kxx1A/B/C $V_{OUT} = 1.2\text{ V}$
MODE = "H" Forced PWM Control

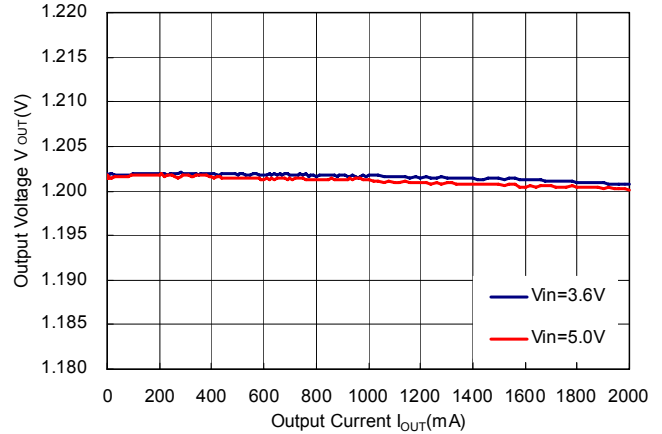

RP506 Kxx1A/B/C $V_{OUT} = 1.8\text{ V}$
MODE = "L" PWM/VFM Auto Switching Control

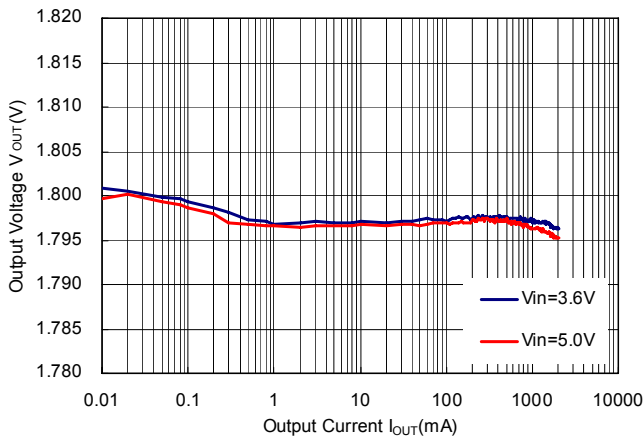

RP506Kxx1A/B/C $V_{OUT} = 1.8\text{ V}$
MODE = "H" Forced PWM Control

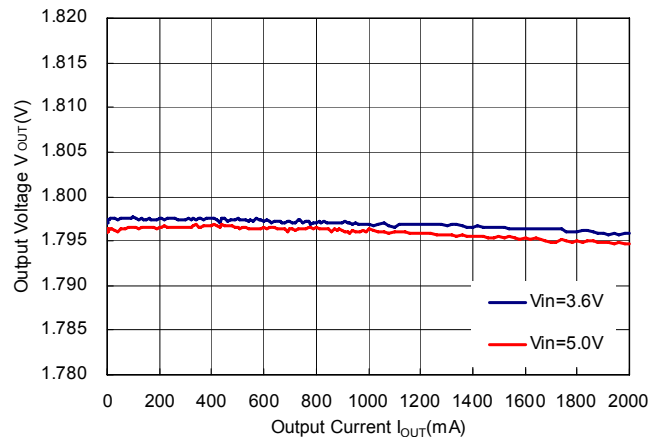

RP506 Kxx1A/B/C $V_{OUT} = 3.3\text{ V}$
MODE = "L" PWM/VFM Auto Switching Control

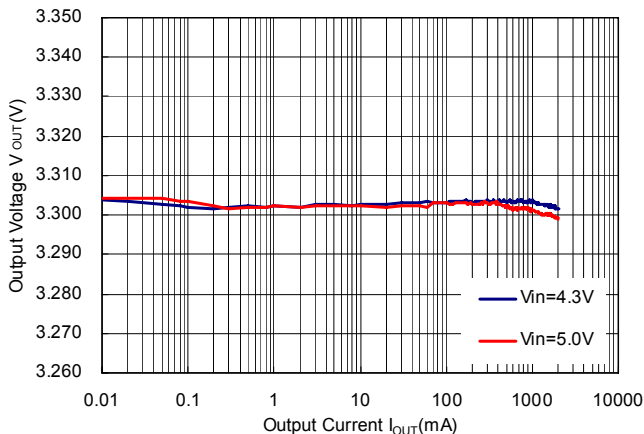

RP506Kxx1A/B/C $V_{OUT} = 3.3\text{ V}$
MODE = "H" Forced PWM Control

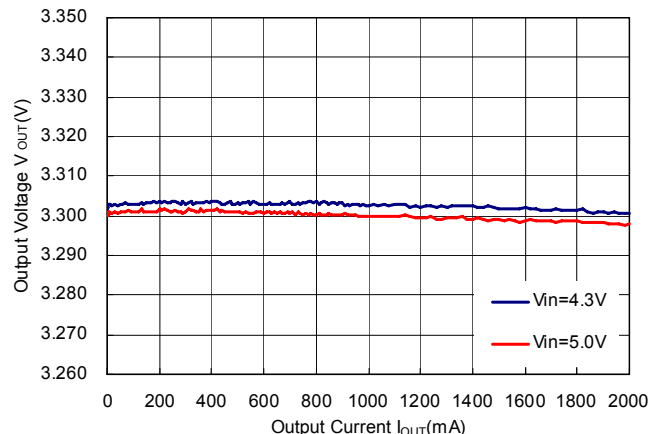

RP506Kxx1D/E/F $V_{OUT} = 0.6\text{ V}$
MODE = "L" PWM/VFM Auto Switching Control

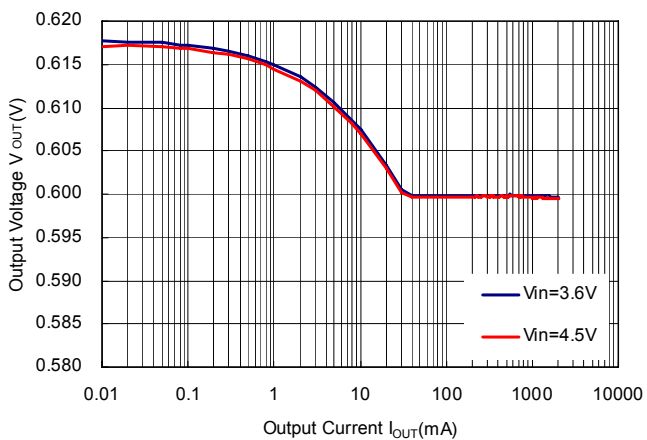

RP506Kxx1D/E/F $V_{OUT} = 0.6\text{ V}$
MODE = "H" Forced PWM Control

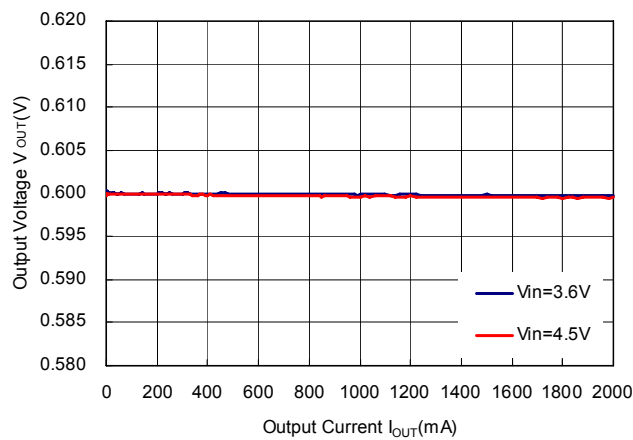

RP506 Kxx1D/E/F $V_{OUT} = 0.8\text{ V}$
MODE = "L" PWM/VFM Auto Switching Control

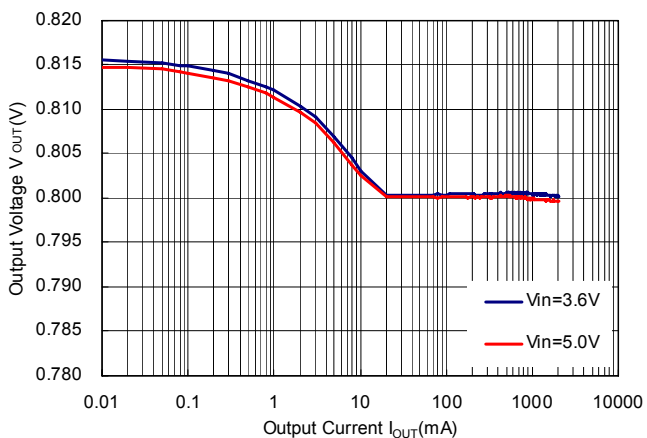

RP506Kxx1D/E/F $V_{OUT} = 0.8\text{ V}$
MODE = "H" Forced PWM Control

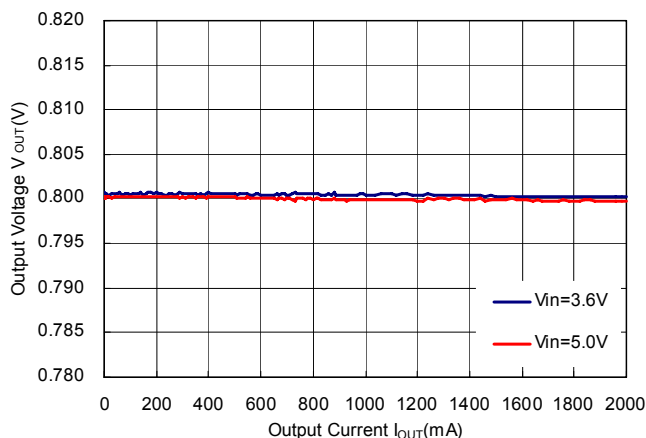

RP506 Kxx1D/E/F $V_{OUT} = 1.2\text{ V}$
MODE = "L" PWM/VFM Auto Switching Control

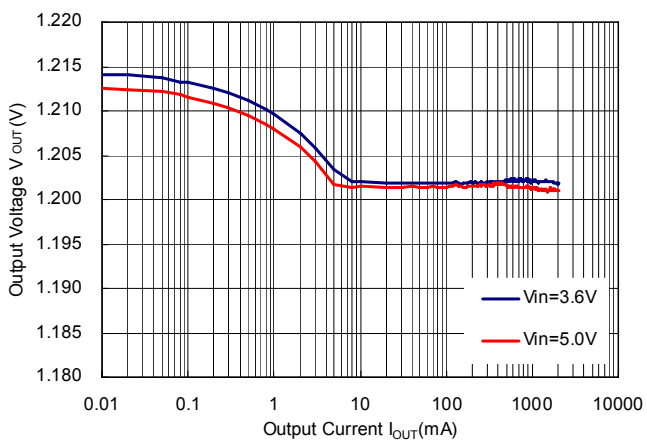

RP506Kxx1D/E/F $V_{OUT} = 1.2\text{ V}$
MODE = "H" Forced PWM Control

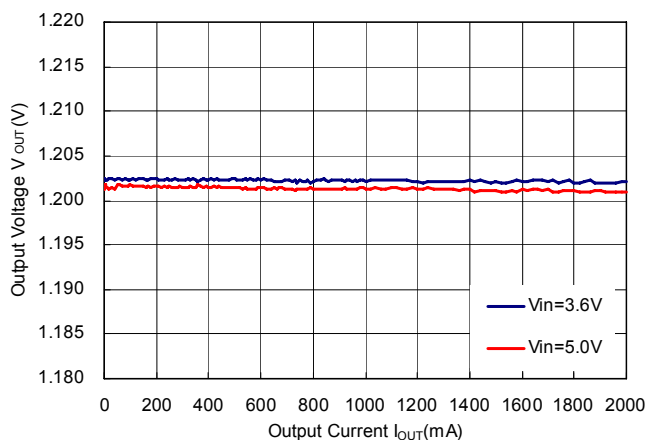

RP506 Kxx1D/E/F $V_{OUT} = 1.8\text{ V}$
MODE = "L" PWM/VFM Auto Switching Control

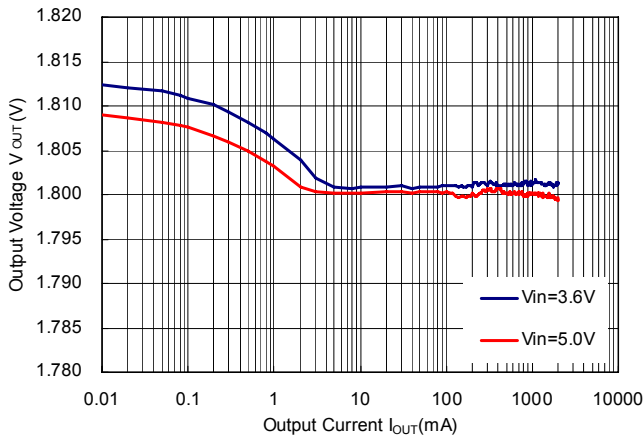

RP506Kxx1D/E/F $V_{OUT} = 1.8\text{ V}$
MODE = "H" Forced PWM Control

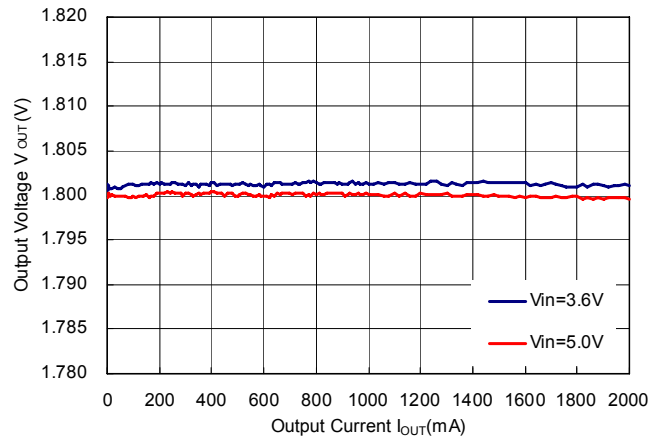

RP506 Kxx1D/E/F $V_{OUT} = 3.3\text{ V}$
MODE = "L" PWM/VFM Auto Switching Control

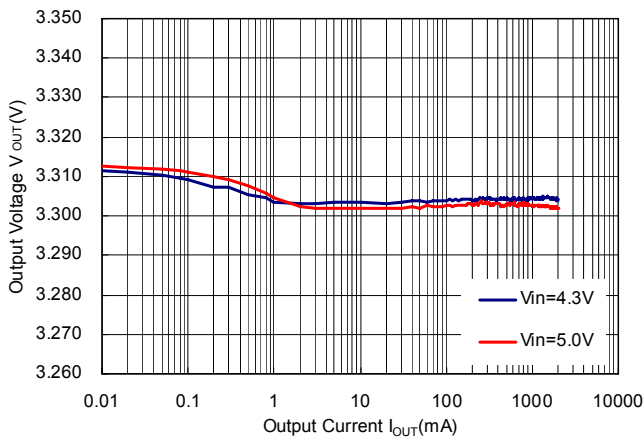

RP506Kxx1D/E/F $V_{OUT} = 3.3\text{ V}$
MODE = "H" Forced PWM Control

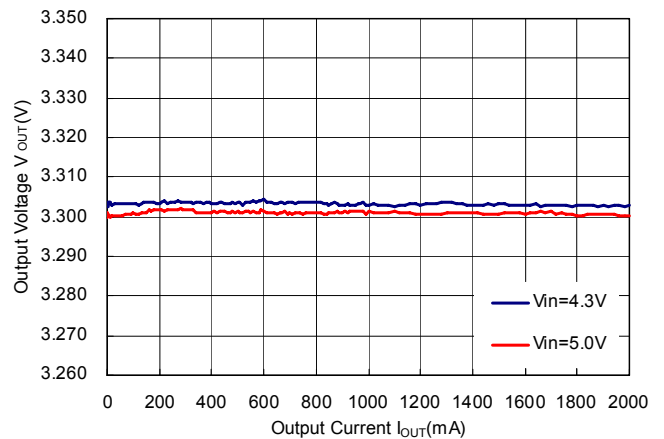

2) Output Voltage vs. Input Voltage

RP506 Kxx1D/E/F $V_{OUT} = 0.6\text{ V}$
MODE = "H" Forced PWM Control

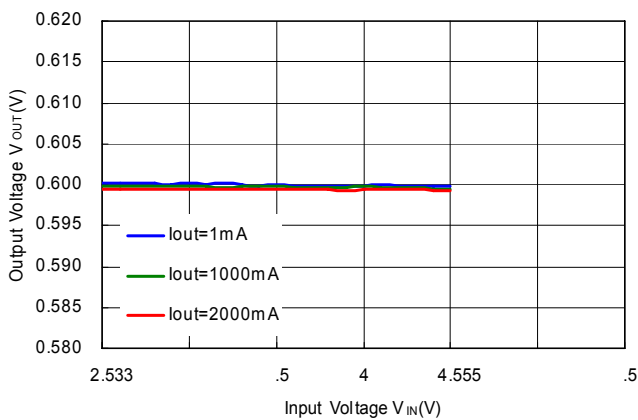

RP506Kxx1D/E/F $V_{OUT} = 0.8\text{ V}$
MODE = "H" Forced PWM Control

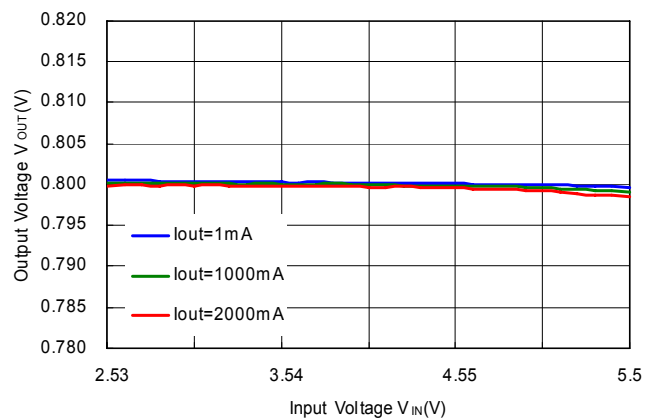

RP506K $V_{OUT} = 1.2\text{ V}$
MODE = "H" Forced PWM Control

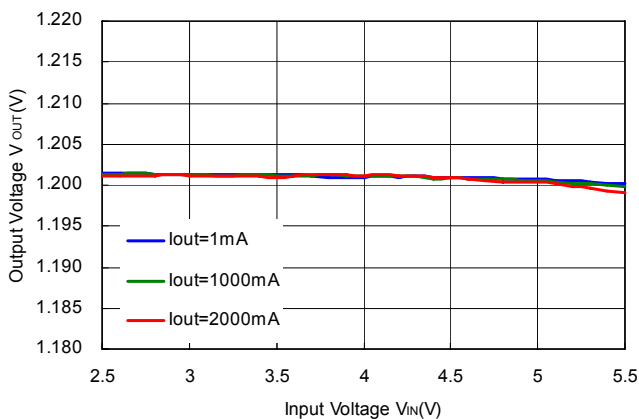

RP506K $V_{OUT} = 1.8\text{ V}$
MODE = "H" Forced PWM Control

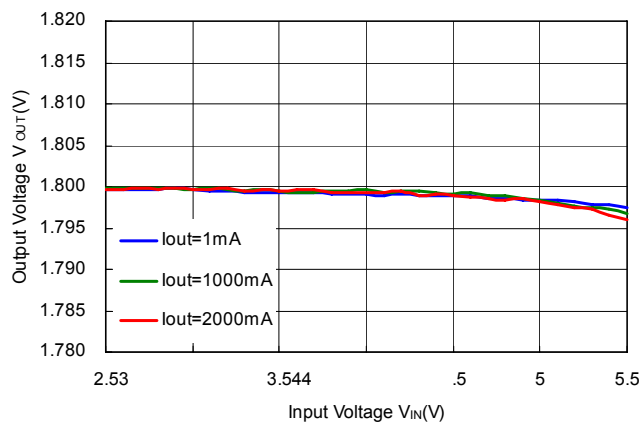

RP506K $V_{OUT} = 3.3\text{ V}$
MODE = "H" Forced PWM Control

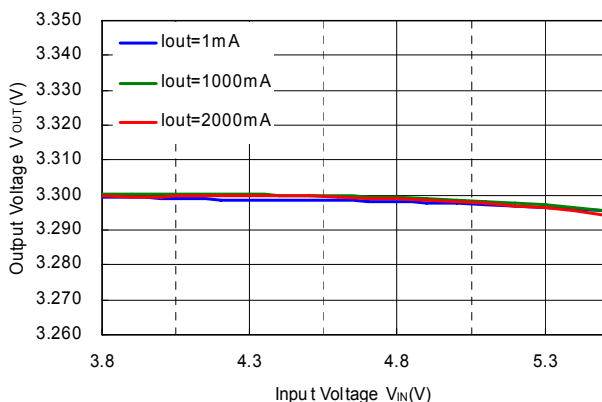

3) Output Voltage vs. Ambient Temperature

RP506K181A/B/D/E $V_{OUT} = 1.8\text{ V}$

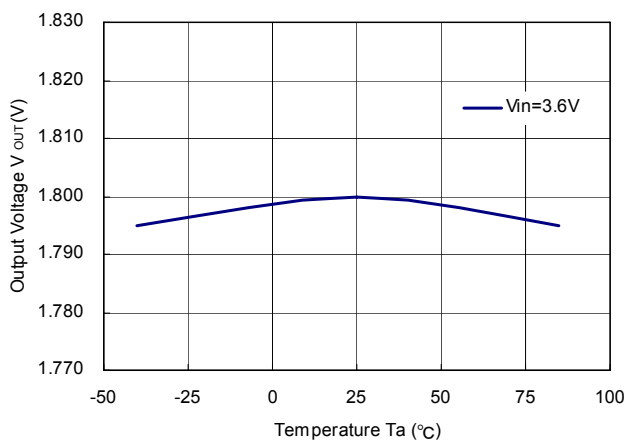

4) Feedback Voltage vs. Ambient Temperature

RP506K001C/F

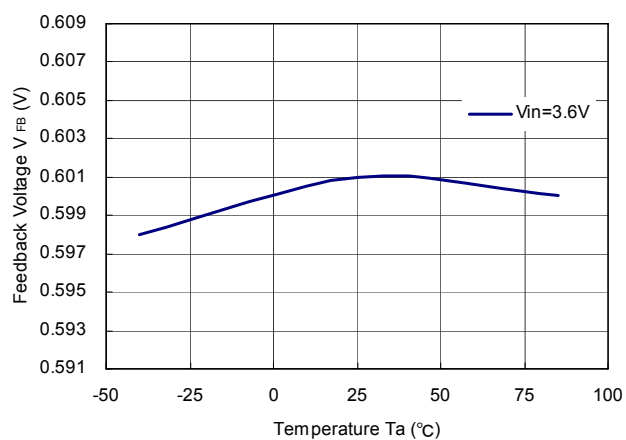

5) Efficiency vs. Output Current

RP506 Kxx1A/B/C $V_{OUT} = 1.2\text{ V}$

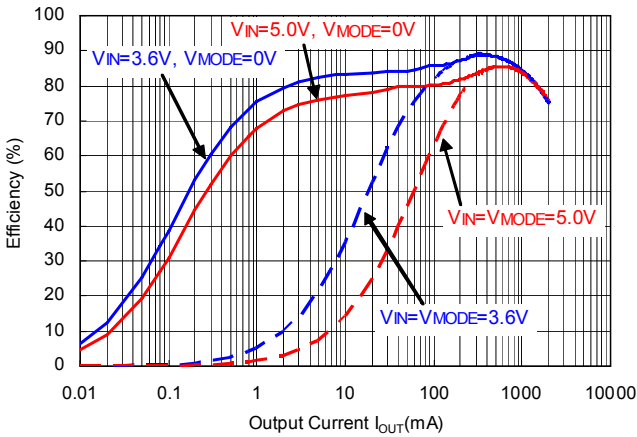

RP506Kxx1A/B/C $V_{OUT} = 1.8\text{ V}$

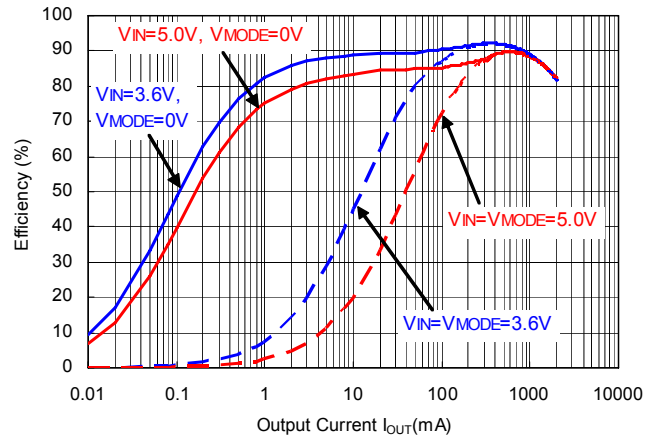

RP506 Kxx1A/B/C $V_{OUT} = 3.3\text{ V}$

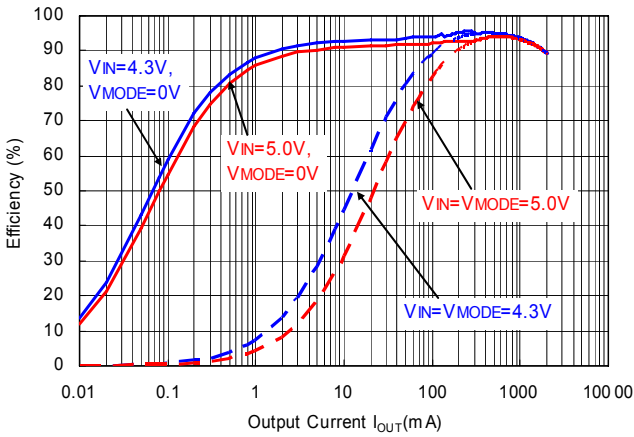

RP506 Kxx1D/E/F $V_{OUT} = 0.6\text{ V}$

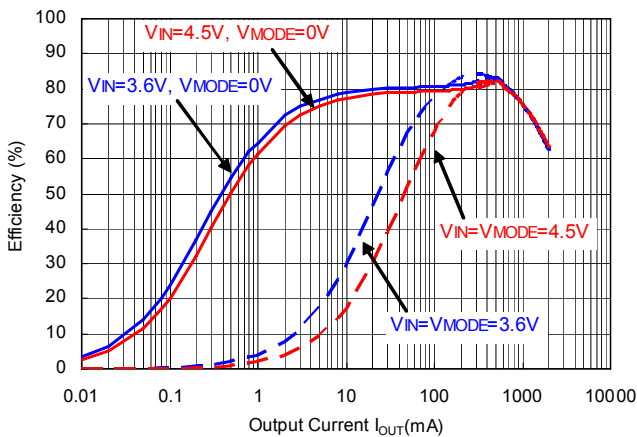

RP506Kxx1D/E/F $V_{OUT} = 0.8\text{ V}$

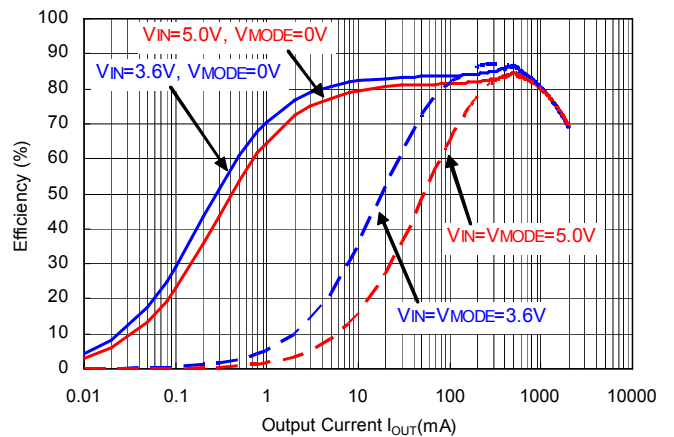

RP506 Kxx1D/E/F V_{OUT} = 1.2 V

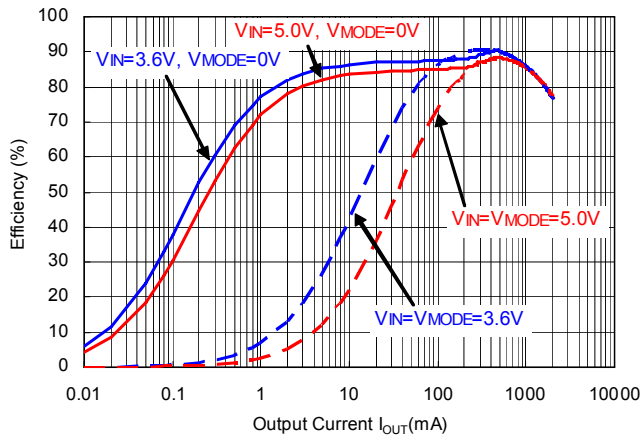

RP506Kxx1D/E/F V_{OUT} = 1.8 V

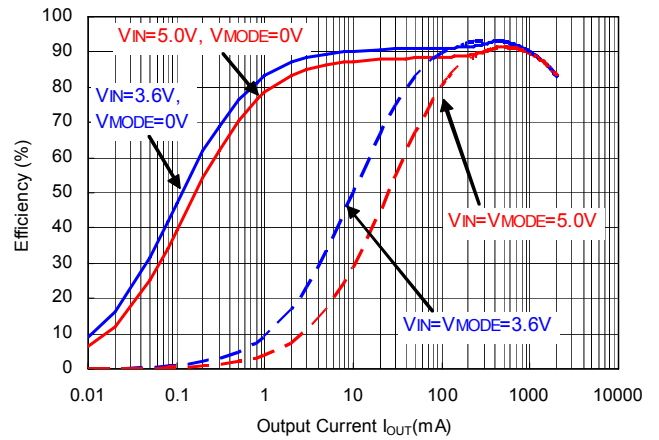

RP506Kxx1D/E/F V_{OUT} = 3.3 V

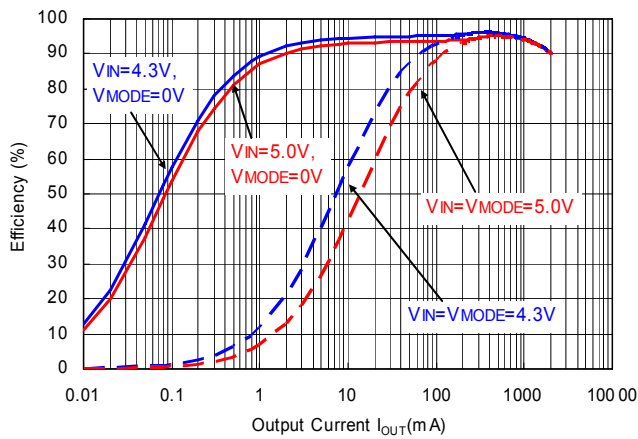

6) Supply Current vs. Ambient Temperature

**RP506 K V_{OUT} = 1.8 V (V_{IN} = 5.5 V)
MODE = "L" PWM/VFM Auto Switching Control**

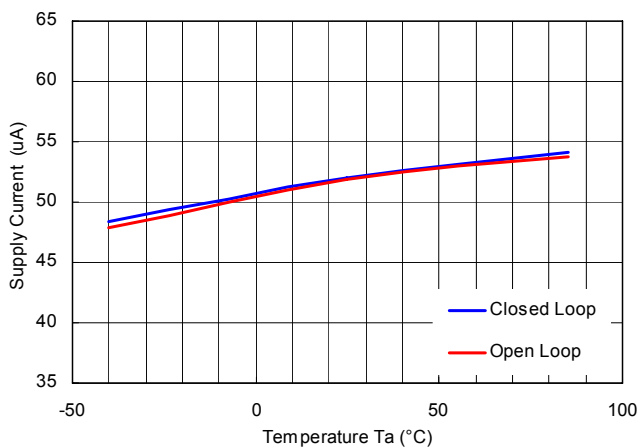

7) Supply Current vs. Input Voltage

**RP506K V_{OUT} = 1.8 V
MODE = "L" PWM/VFM Auto Switching Control**

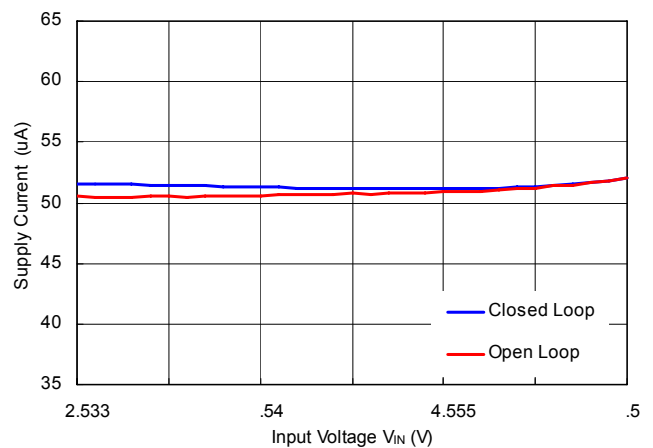

8) Output Voltage Waveform

RP506 Kxx1A/B/C $V_{OUT} = 0.8\text{ V}$ ($V_{IN} = 3.6\text{ V}$)

MODE = "L" PWM/VFM Auto Switching Control

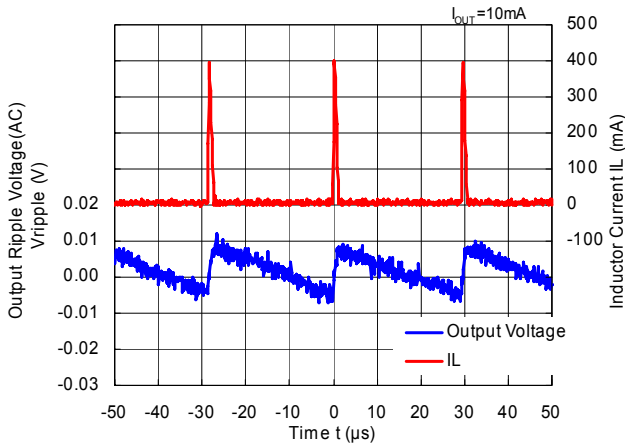

RP506Kxx1A/B/C $V_{OUT} = 1.2\text{ V}$ ($V_{IN} = 3.6\text{ V}$)

MODE = "L" PWM/VFM Auto Switching Control

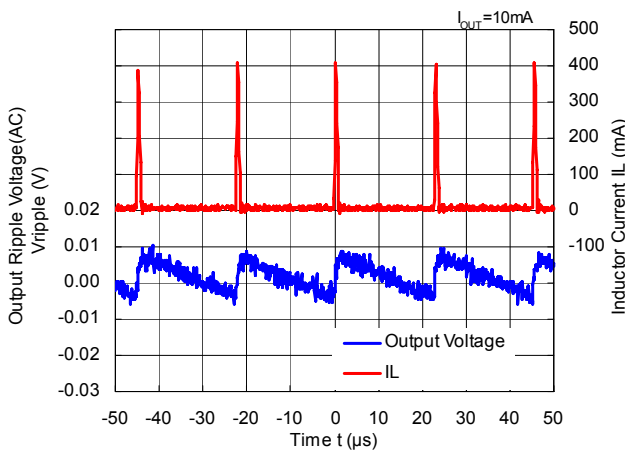

RP506Kxx1A/B/C $V_{OUT} = 1.2\text{ V}$ ($V_{IN} = 3.6\text{ V}$)

MODE = "H" Forced PWM Control

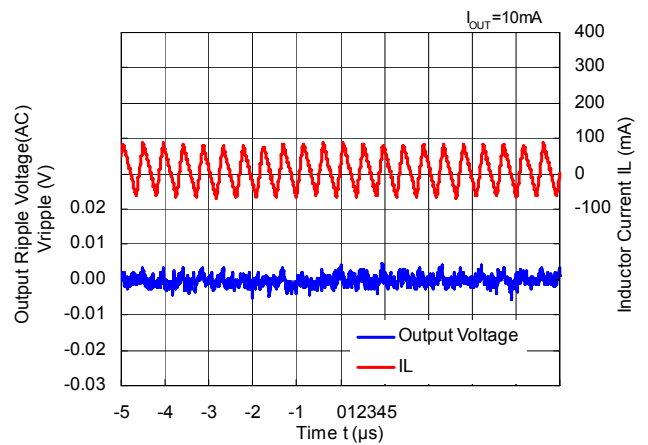

RP506Kxx1A/B/C $V_{OUT} = 1.8\text{ V}$ ($V_{IN} = 3.6\text{ V}$)

MODE = "L" PWM/VFM Auto Switching Control

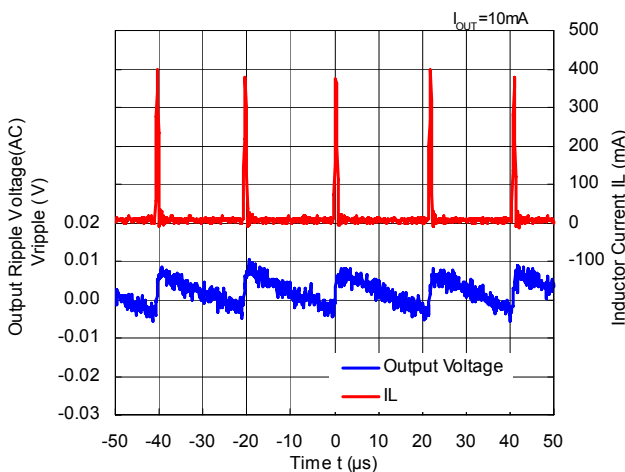

RP506Kxx1A/B/C $V_{OUT} = 1.8\text{ V}$ ($V_{IN} = 3.6\text{ V}$)

MODE = "H" Forced PWM Control

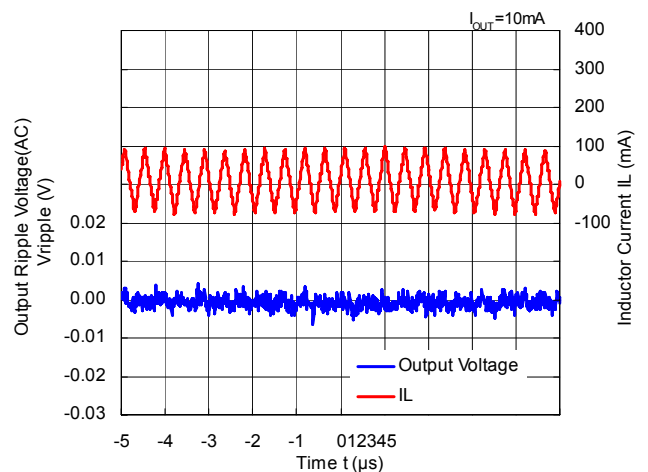

RP506Kxx1A/B/C $V_{OUT} = 3.3\text{ V}(V_{IN} = 5.0\text{ V})$
MODE = "L" PWM/VFM Auto Switching Control

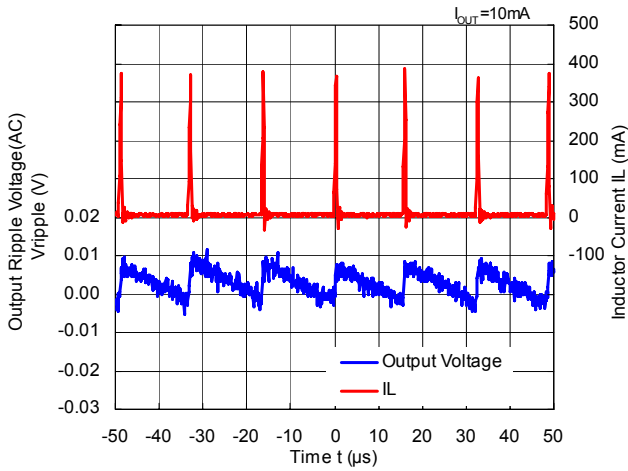

RP506Kxx1A/B/C $V_{OUT} = 1.8\text{ V}(V_{IN} = 5.0\text{ V})$
MODE = "H" Forced PWM Control

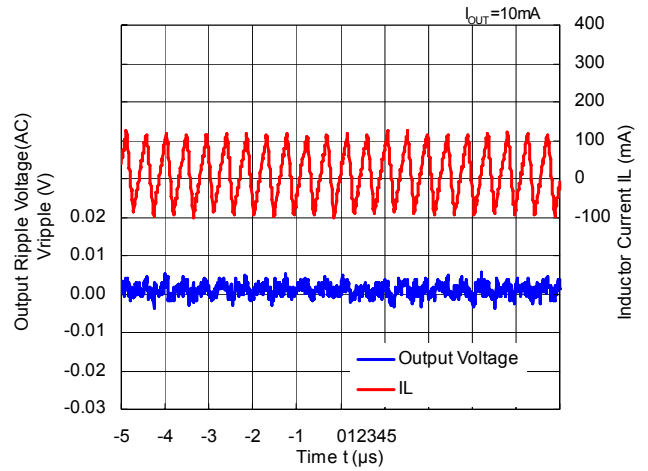

RP506Kxx1D/E/F $V_{OUT} = 0.6\text{ V}(V_{IN} = 3.6\text{ V})$
MODE = "L" PWM/VFM Auto Switching Control

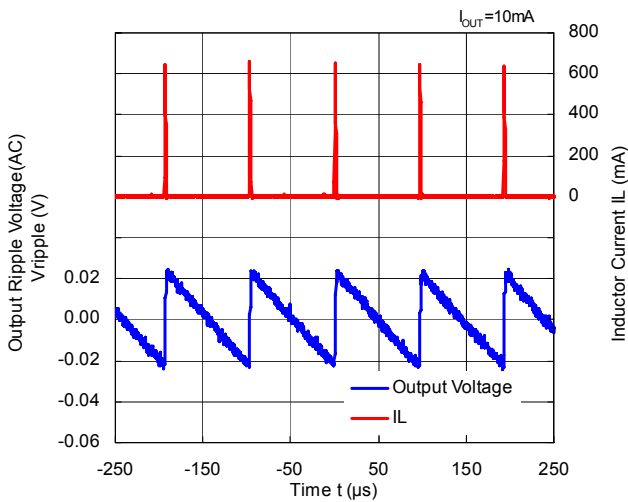

RP506Kxx1D/E/F $V_{OUT} = 0.6\text{ V}(V_{IN} = 3.6\text{ V})$
MODE = "H" Forced PWM Control

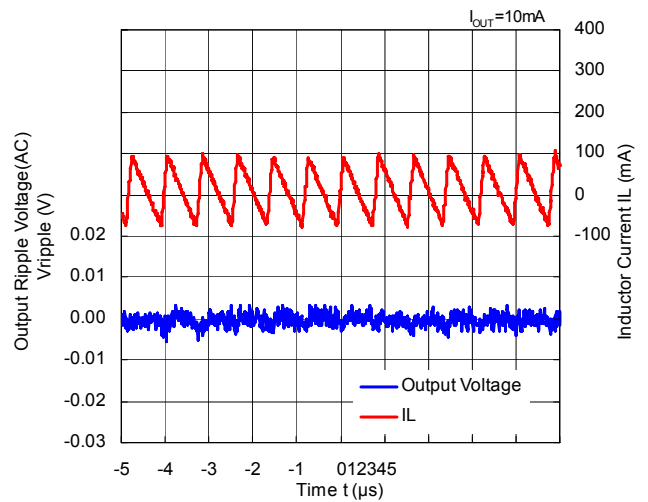

RP506Kxx1D/E/F $V_{OUT} = 0.8\text{ V}(V_{IN} = 3.6\text{ V})$
MODE = "L" PWM/VFM Auto Switching Control

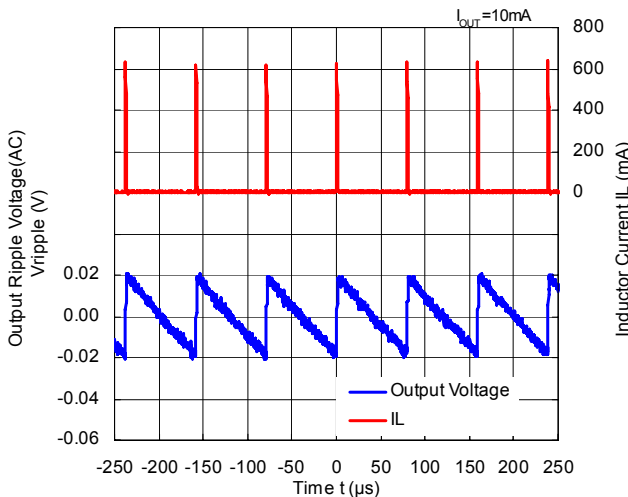

RP506Kxx1D/E/F $V_{OUT} = 0.8\text{ V}(V_{IN} = 3.6\text{ V})$
MODE = "H" Forced PWM Control

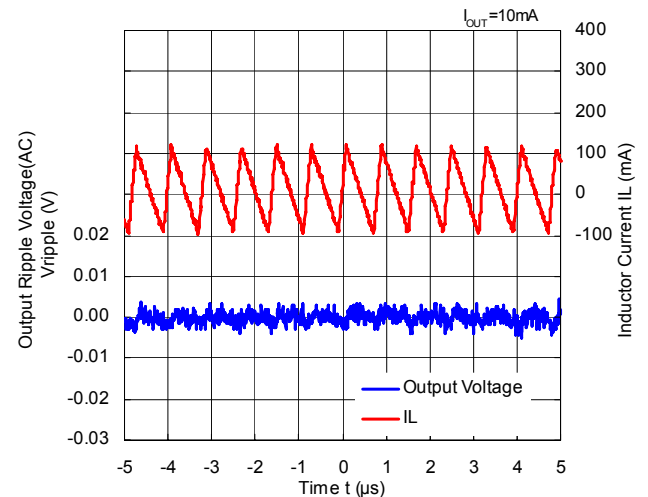

RP506Kxx1D/E/F $V_{OUT} = 1.2\text{ V}(V_{IN} = 3.6\text{ V})$
MODE = "L" PWM/VFM Auto Switching Control

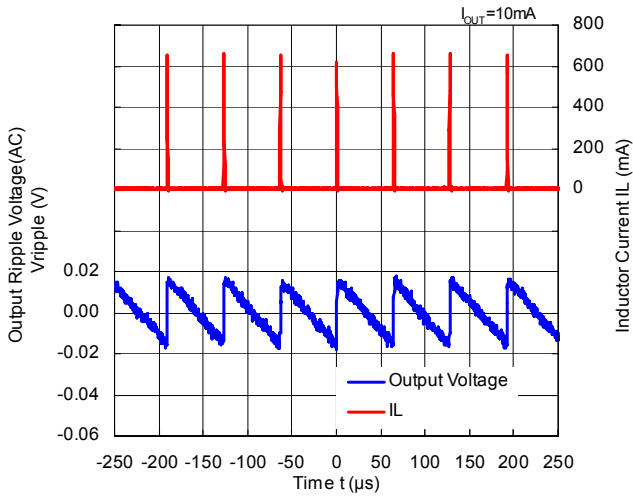

RP506Kxx1D/E/F $V_{OUT} = 1.2\text{ V}(V_{IN} = 3.6\text{ V})$
MODE = "H" Forced PWM Control

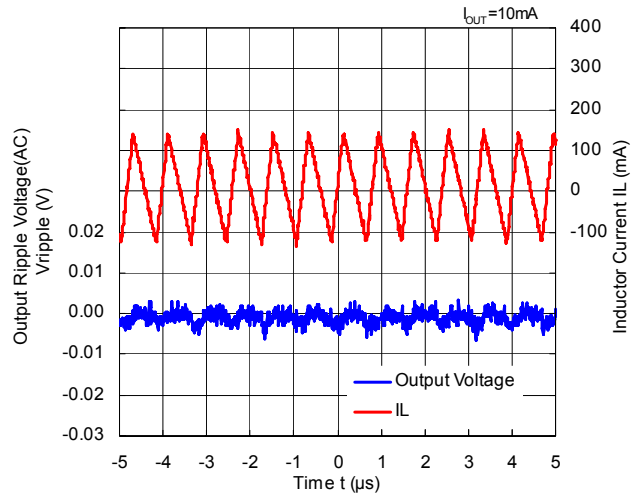

RP506Kxx1D/E/F $V_{OUT} = 1.8\text{ V}(V_{IN} = 3.6\text{ V})$
MODE = "L" PWM/VFM Auto Switching Control

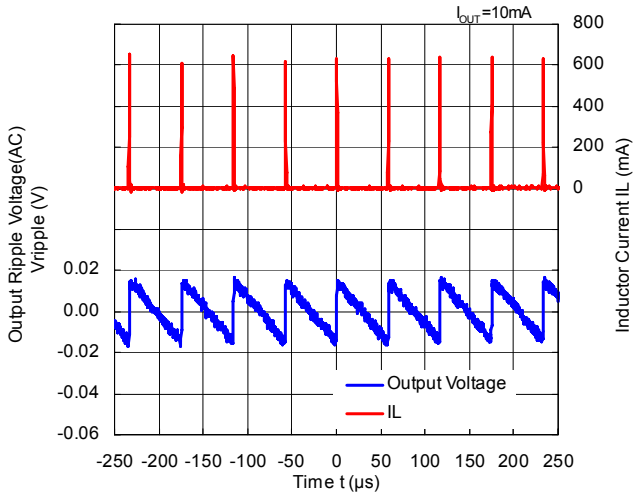

RP506Kxx1D/E/F $V_{OUT} = 1.8\text{ V}(V_{IN} = 3.6\text{ V})$
MODE = "H" Forced PWM Control

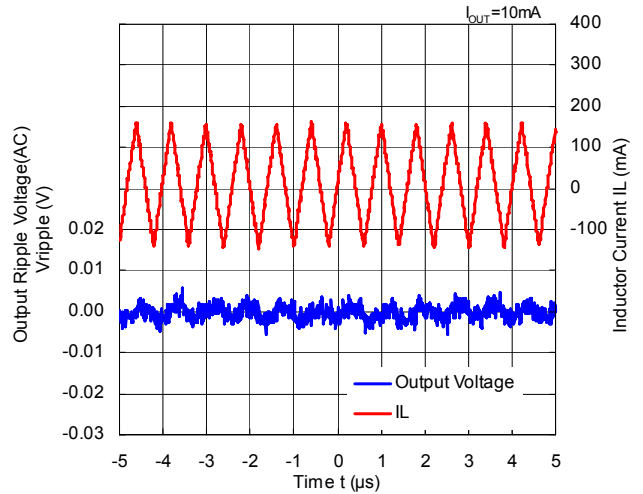

RP506Kxx1D/E/F $V_{OUT} = 3.3\text{ V}(V_{IN} = 5.0\text{ V})$
MODE = "L" PWM/VFM Auto Switching Control

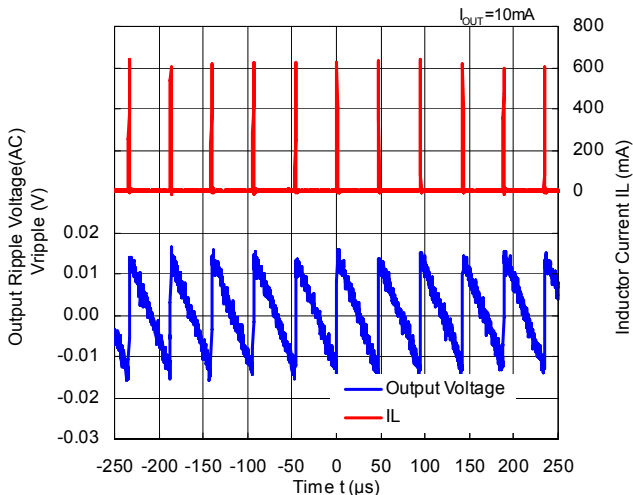

RP506Kxx1D/E/F $V_{OUT} = 3.3\text{ V}(V_{IN} = 5.0\text{ V})$
MODE = "H" Forced PWM Control

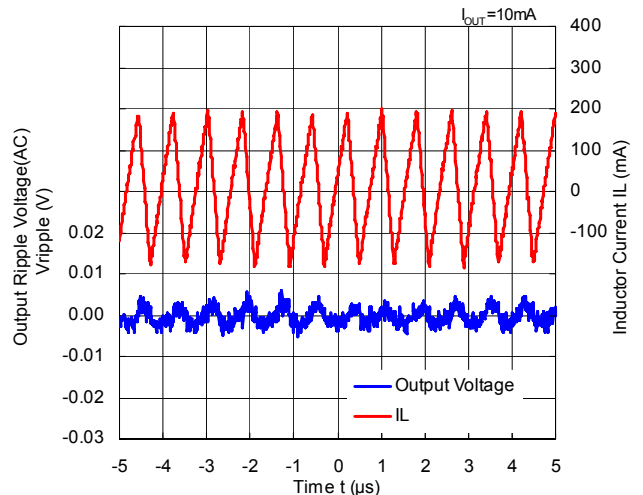

9) Oscillator Frequency vs. Ambient Temperature

RP506

Kxx1A/B/C

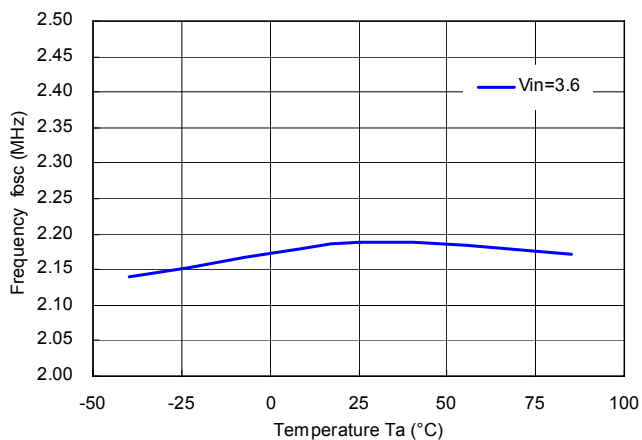

RP506Kxx1D/E/F

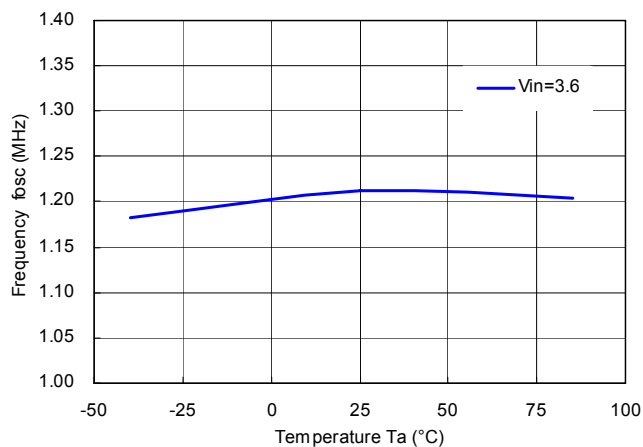

10) Oscillator Frequency vs. Input Voltage

RP506

Kxx1A/B/C

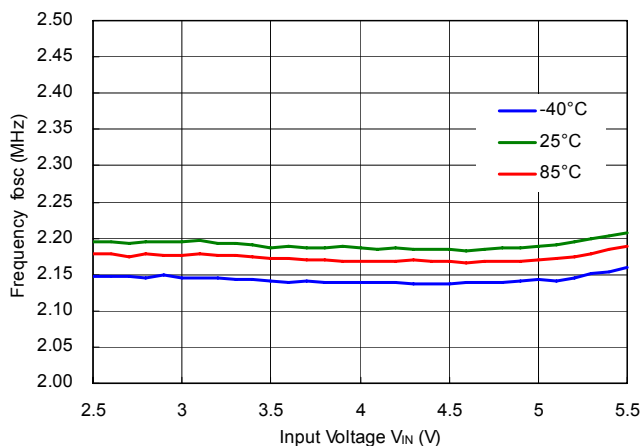

RP506Kxx1D/E/F

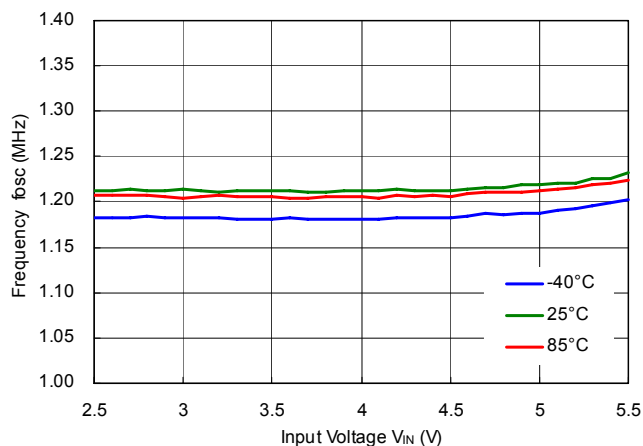

11) Soft-start Time vs. Ambient Temperature

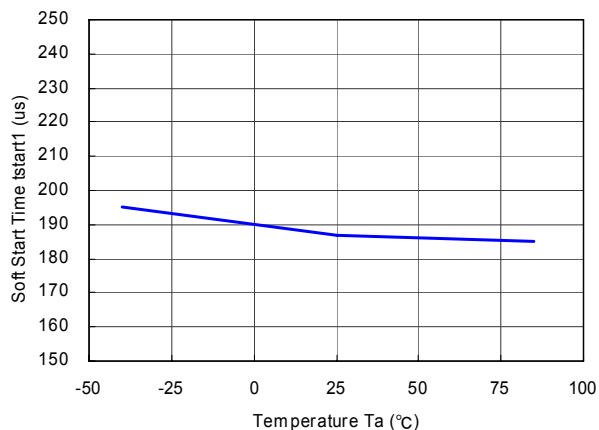

12) UVLO Detector Threshold/ Released Voltage vs. Ambient Temperature

UVLO Detector Threshold

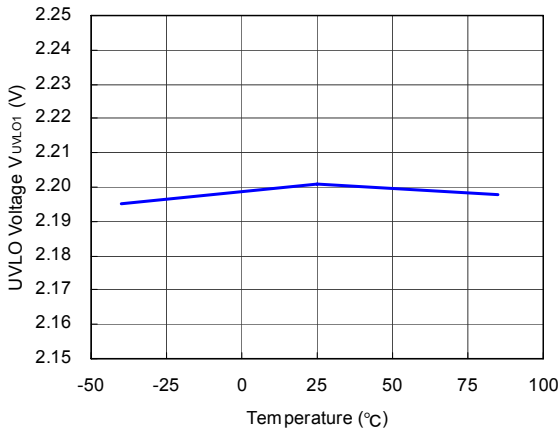

UVLO Released Voltage

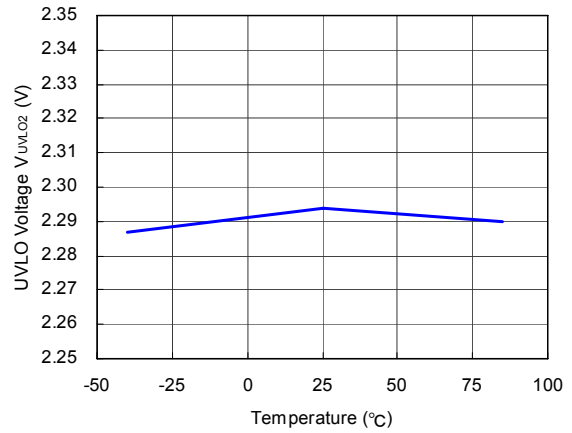

13) CE Input Voltage vs. Ambient Temperature

CE“H” Input Voltage ($V_{IN} = 5.5 V$)

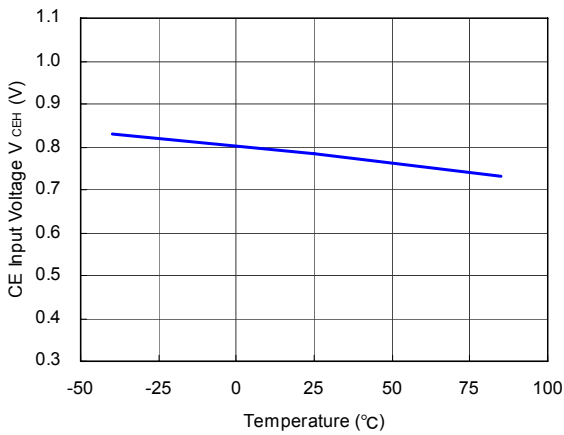

CE“L” Input Voltage ($V_{IN} = 2.5 V$)

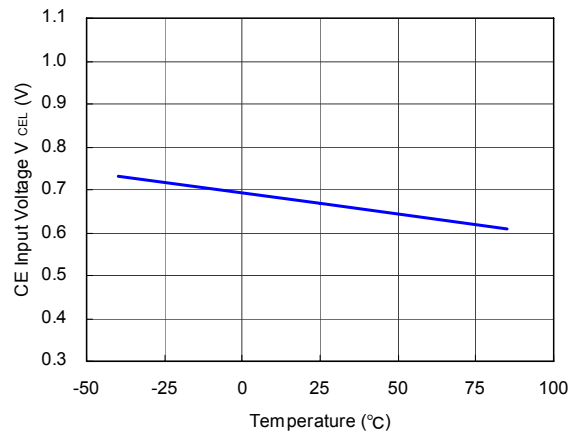

14) Lx Limit Current vs. Ambient Temperature

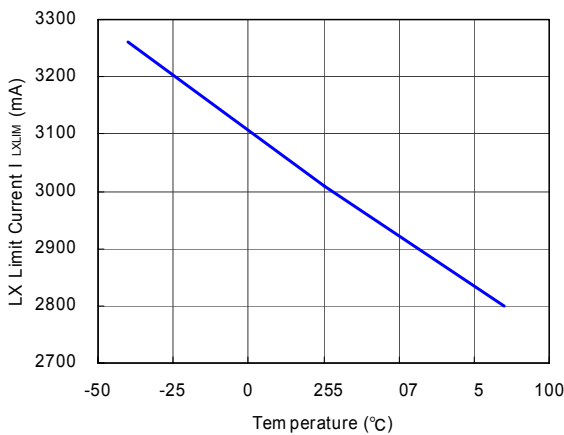

15) Nch Tr. ON Resistance vs. Ambient Temperature

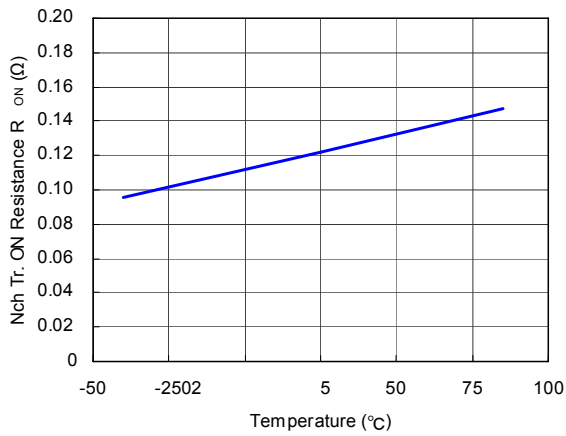

16) Pch Tr. ON Resistance vs. Ambient Temperature

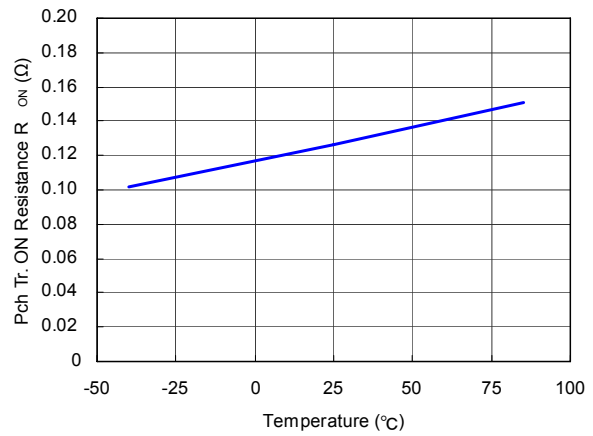

17) PG Detector Threshold vs. Ambient Temperature

Over Voltage Detection (V_{OVD})

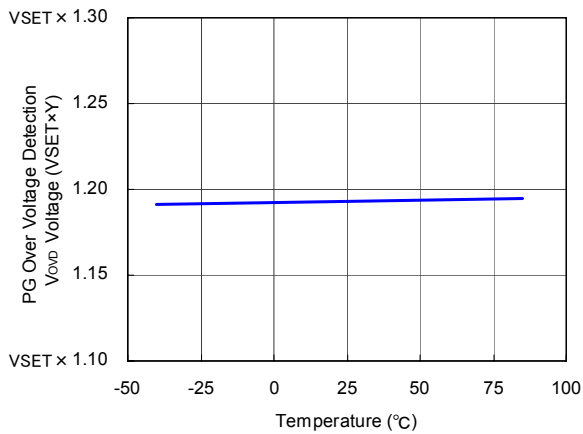

Under Voltage Detection (V_{UVD})

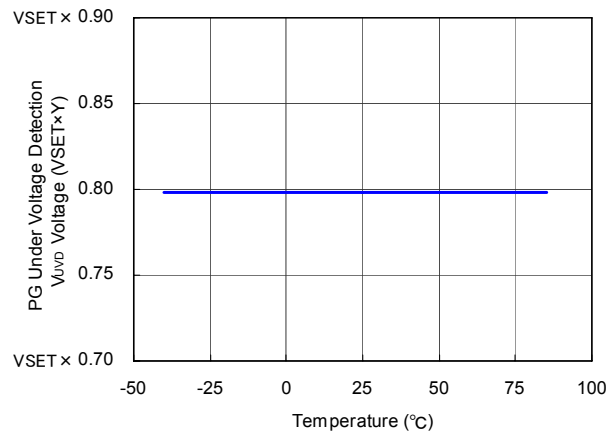

18) Soft-start Waveform

RP506K $V_{OUT} = 1.8 V$ $T_{SS} = \text{Open}$

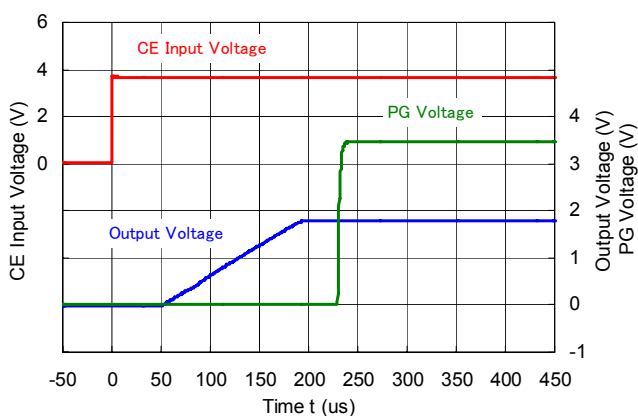

RP506K $V_{OUT} = 1.8 V$ $T_{SS} = 0.1 \mu F$

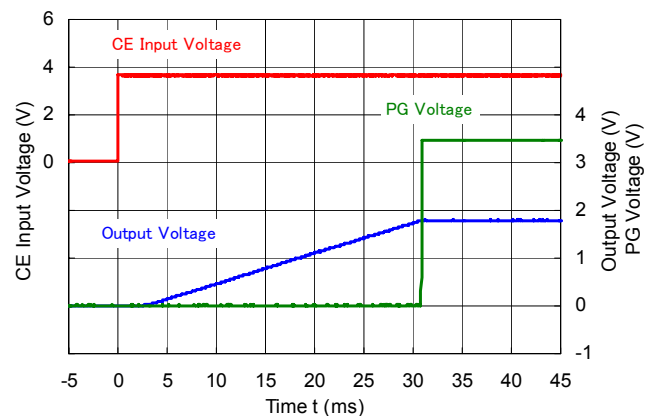

19) Load Transient Response

RP506Kxx1A/B/C ($V_{IN} = 3.6\text{ V}$, $V_{OUT} = 0.8\text{ V}$)

MODE = "L" PWM/VFM Auto Switching Control

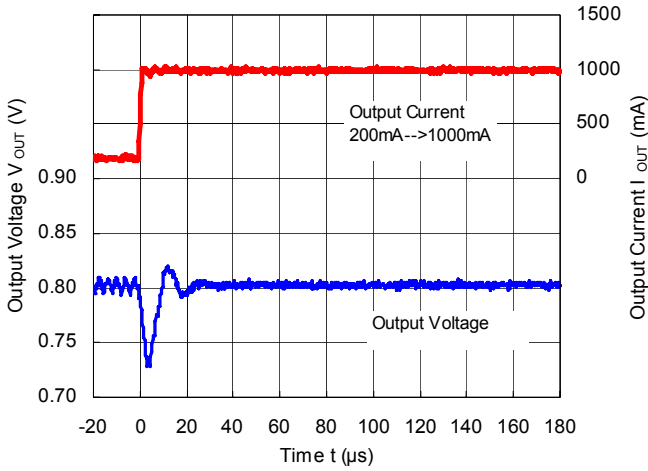

RP506Kxx1A/B/C ($V_{IN} = 3.6\text{ V}$, $V_{OUT} = 0.8\text{ V}$)

MODE = "L" PWM/VFM Auto Switching Control

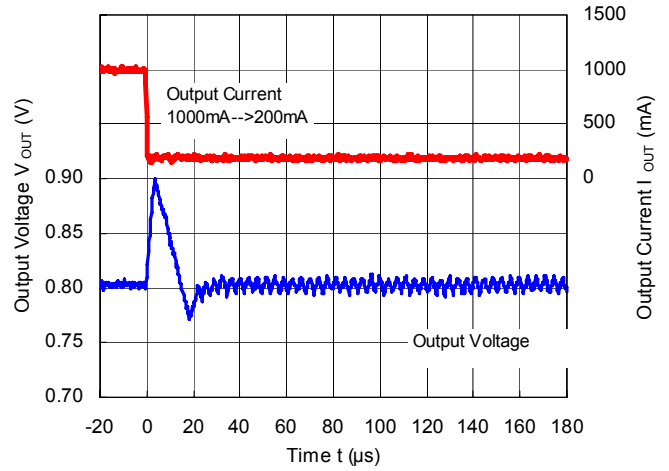

RP506Kxx1A/B/C ($V_{IN} = 3.6\text{ V}$, $V_{OUT} = 0.8\text{ V}$)

MODE = "L" PWM/VFM Auto Switching Control

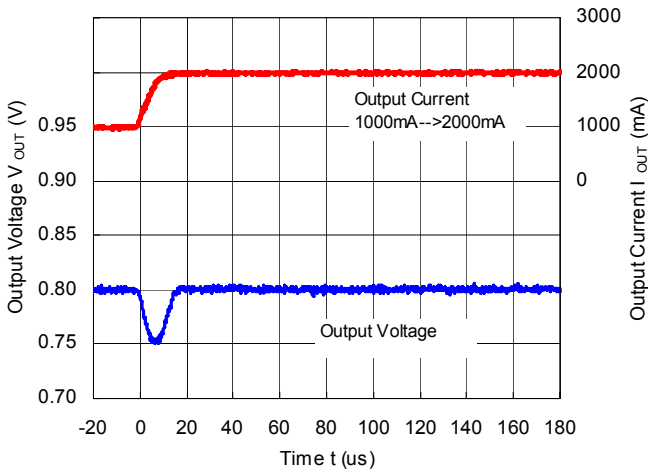

RP506Kxx1A/B/C ($V_{IN} = 3.6\text{ V}$, $V_{OUT} = 0.8\text{ V}$)

MODE = "L" PWM/VFM Auto Switching Control

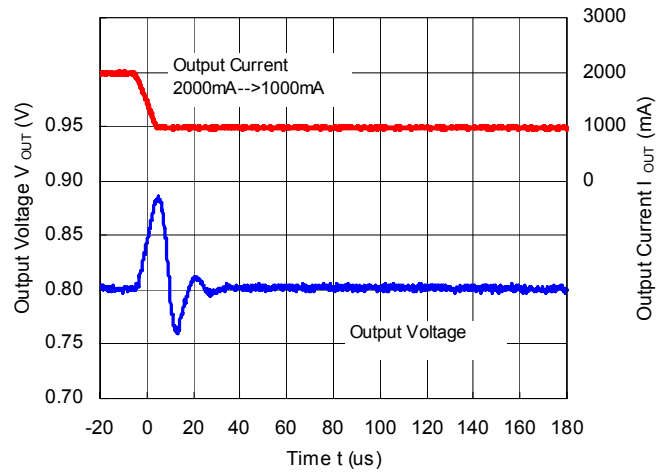

RP506Kxx1A/B/C ($V_{IN} = 3.6\text{ V}$, $V_{OUT} = 1.2\text{ V}$)
MODE = "L" PWM/VFM Auto Switching Control

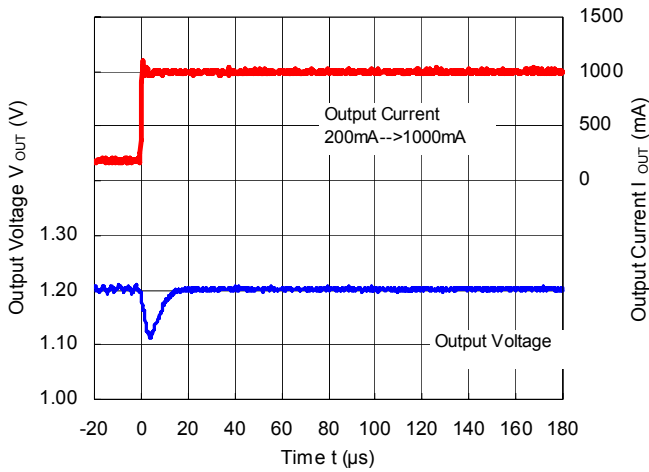

RP506Kxx1A/B/C ($V_{IN} = 3.6\text{ V}$, $V_{OUT} = 1.2\text{ V}$)
MODE = "L" PWM/VFM Auto Switching Control

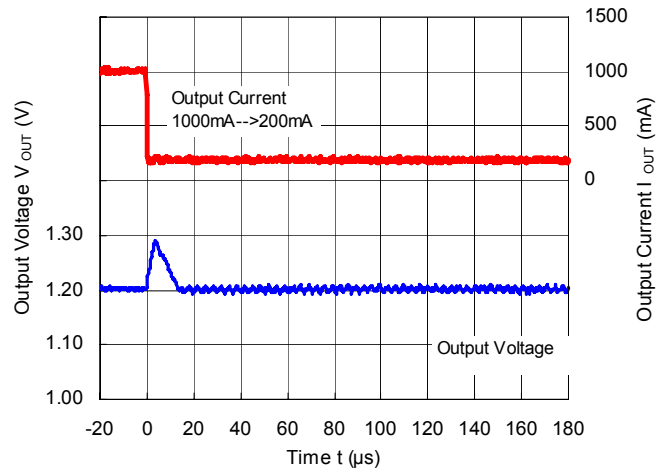

RP506Kxx1A/B/C ($V_{IN} = 3.6\text{ V}$, $V_{OUT} = 1.2\text{ V}$)
MODE = "H" Forced PWM Control

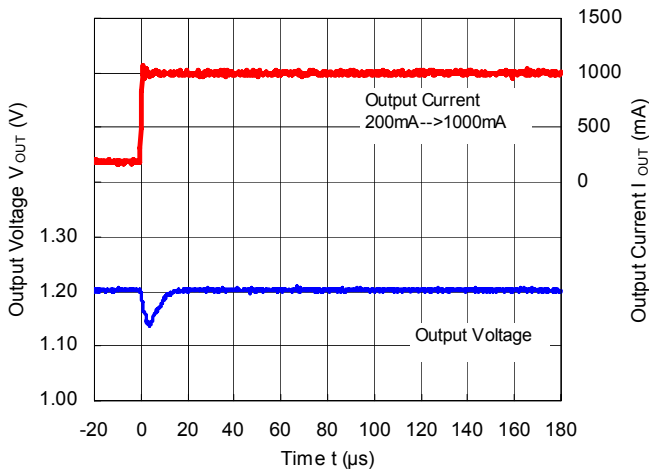

RP506Kxx1A/B/C ($V_{IN} = 3.6\text{ V}$, $V_{OUT} = 1.2\text{ V}$)
MODE = "H" Forced PWM Control

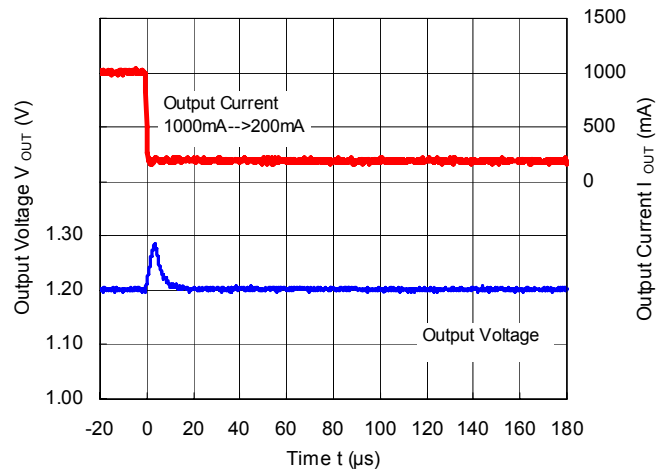

RP506Kxx1A/B/C ($V_{IN} = 3.6\text{ V}$, $V_{OUT} = 1.2\text{ V}$)

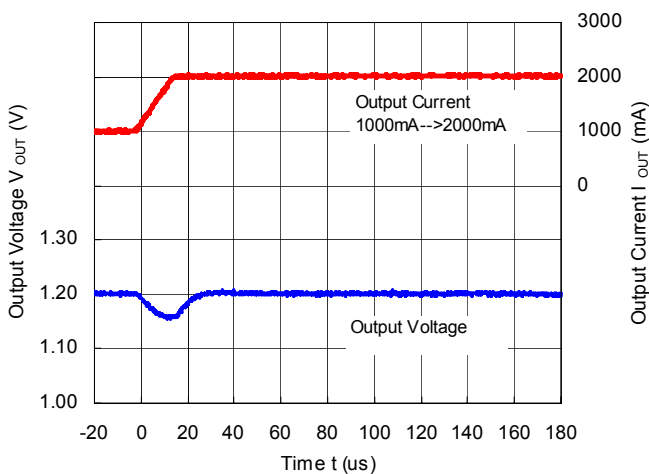

RP506Kxx1A/B/C ($V_{IN} = 3.6\text{ V}$, $V_{OUT} = 1.2\text{ V}$)

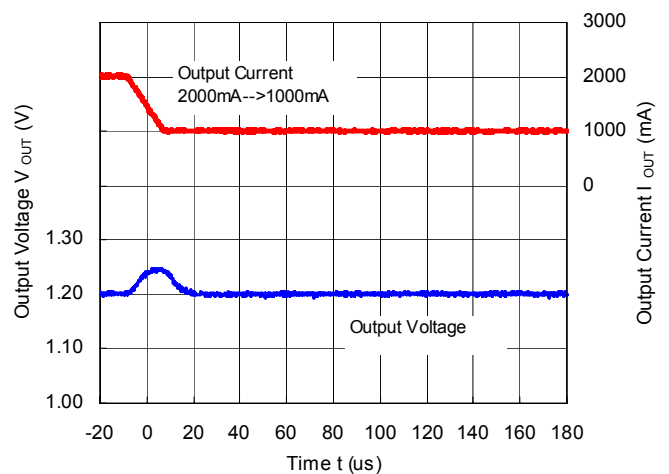

RP506Kxx1A/B/C ($V_{IN} = 3.6\text{ V}$, $V_{OUT} = 1.8\text{ V}$)
MODE = "L" PWM/VFM Auto Switching Control

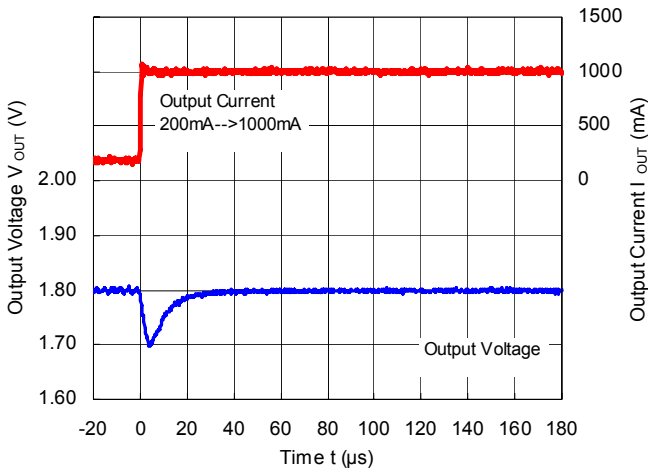

RP506Kxx1A/B/C ($V_{IN} = 3.6\text{ V}$, $V_{OUT} = 1.8\text{ V}$)
MODE = "L" PWM/VFM Auto Switching Control

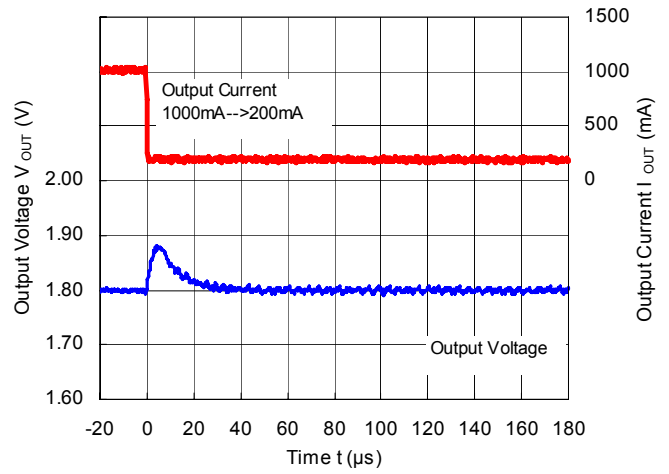

RP506Kxx1A/B/C ($V_{IN} = 3.6\text{ V}$, $V_{OUT} = 1.8\text{ V}$)
MODE = "H" Forced PWM Control

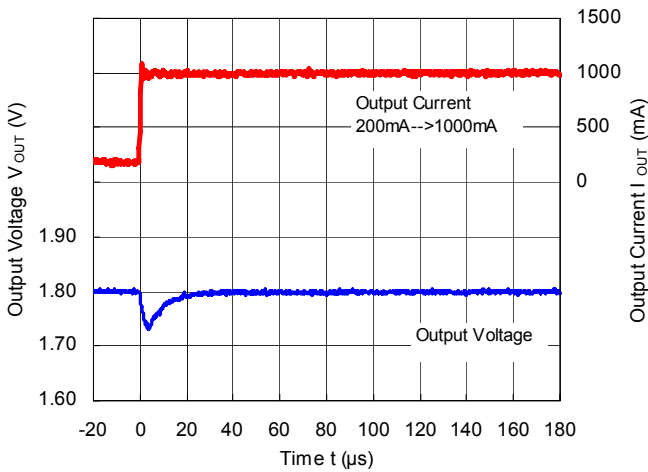

RP506Kxx1A/B/C ($V_{IN} = 3.6\text{ V}$, $V_{OUT} = 1.8\text{ V}$)
MODE = "H" Forced PWM Control

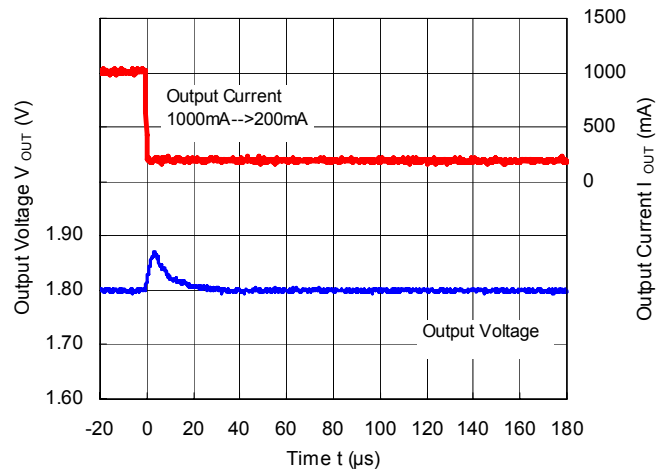

RP506Kxx1A/B/C ($V_{IN} = 3.6\text{ V}$, $V_{OUT} = 1.8\text{ V}$)

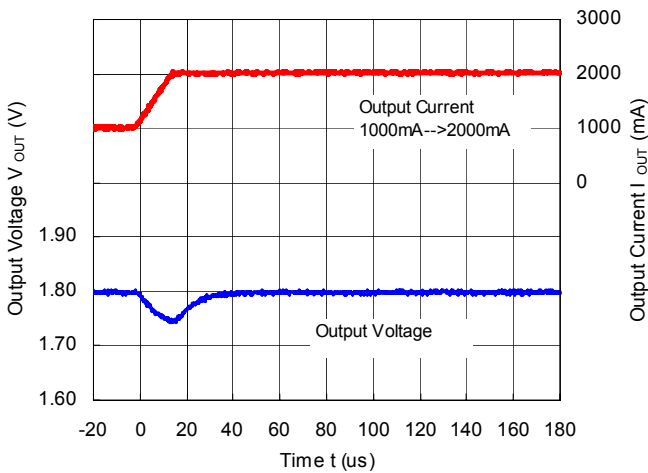

RP506Kxx1A/B/C ($V_{IN} = 3.6\text{ V}$, $V_{OUT} = 1.8\text{ V}$)

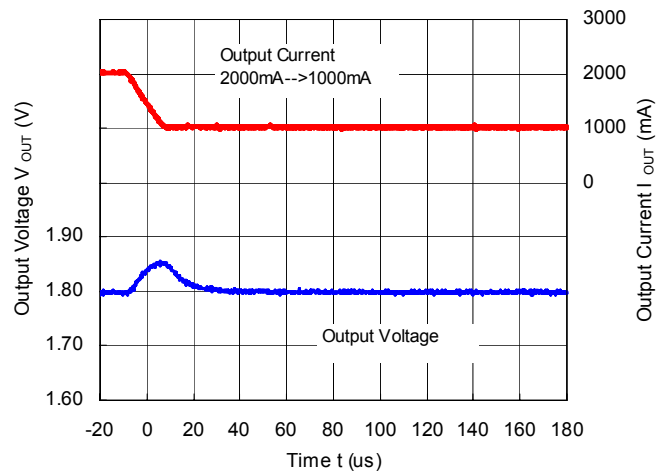

RP506Kxx1A/B/C ($V_{IN} = 5.0\text{ V}$, $V_{OUT} = 3.3\text{ V}$)
MODE = "L" PWM/VFM Auto Switching Control

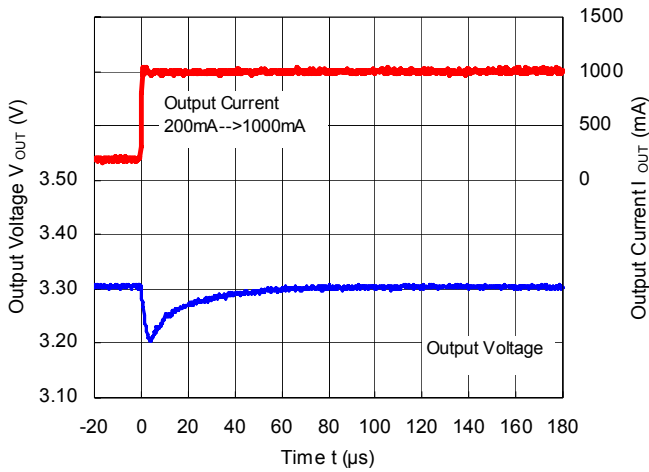

RP506Kxx1A/B/C ($V_{IN} = 5.0\text{ V}$, $V_{OUT} = 3.3\text{ V}$)
MODE = "L" PWM/VFM Auto Switching Control

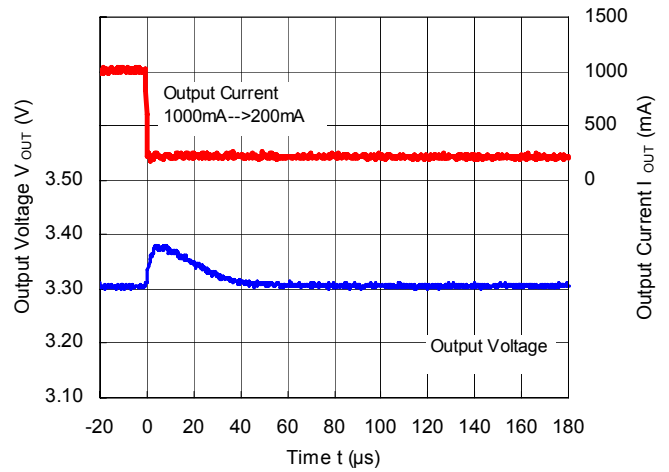

RP506Kxx1A/B/C ($V_{IN} = 5.0\text{ V}$, $V_{OUT} = 3.3\text{ V}$)
MODE = "H" Forced PWM Control

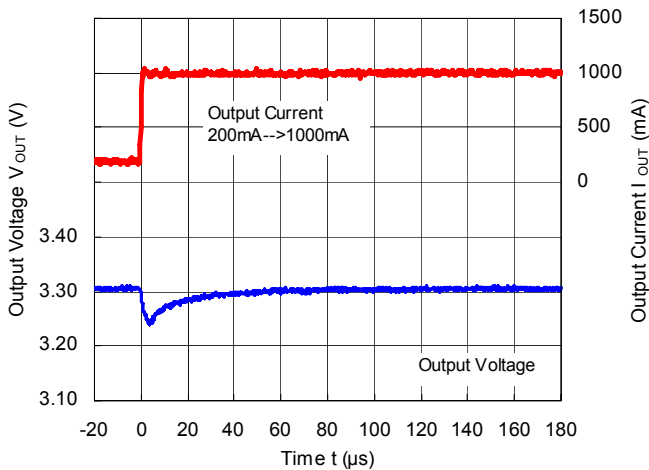

RP506Kxx1A/B/C ($V_{IN} = 5.0\text{ V}$, $V_{OUT} = 3.3\text{ V}$)
MODE = "H" Forced PWM Control

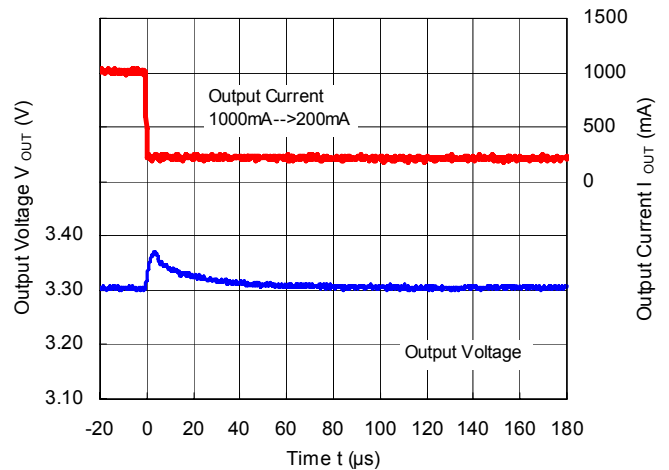

RP506Kxx1A/B/C ($V_{IN} = 5.0\text{ V}$, $V_{OUT} = 3.3\text{ V}$)

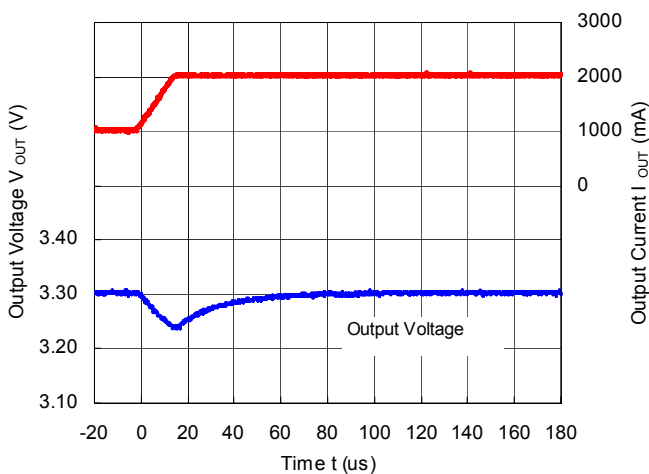

RP506Kxx1A/B/C ($V_{IN} = 5.0\text{ V}$, $V_{OUT} = 3.3\text{ V}$)

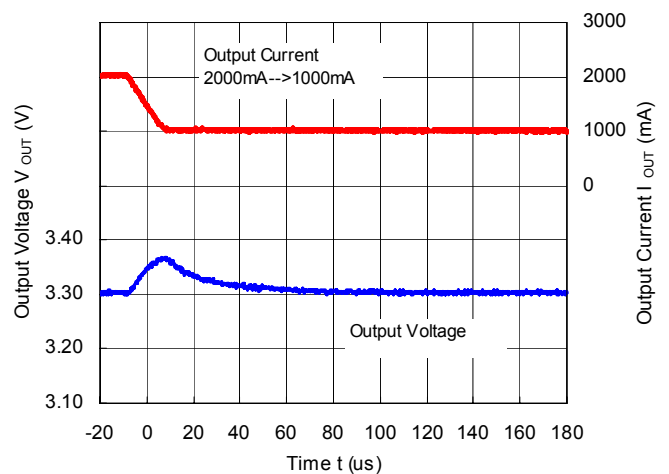

RP506Kxx1D/E/F ($V_{IN} = 3.6\text{ V}$, $V_{OUT} = 0.6\text{ V}$)
MODE = "L" PWM/VFM Auto Switching Control

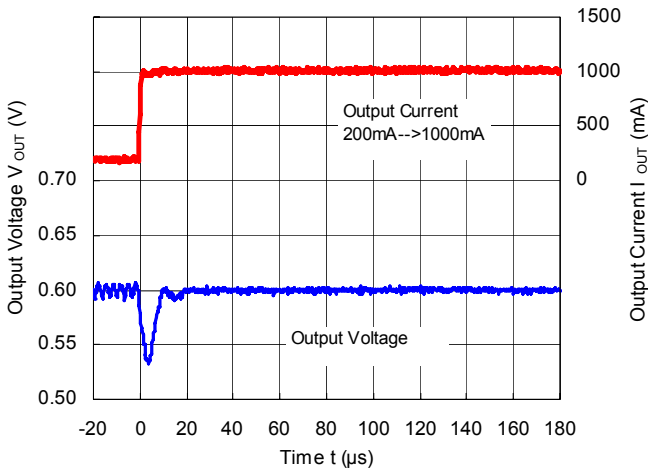

RP506Kxx1D/E/F ($V_{IN} = 3.6\text{ V}$, $V_{OUT} = 0.6\text{ V}$)
MODE = "L" PWM/VFM Auto Switching Control

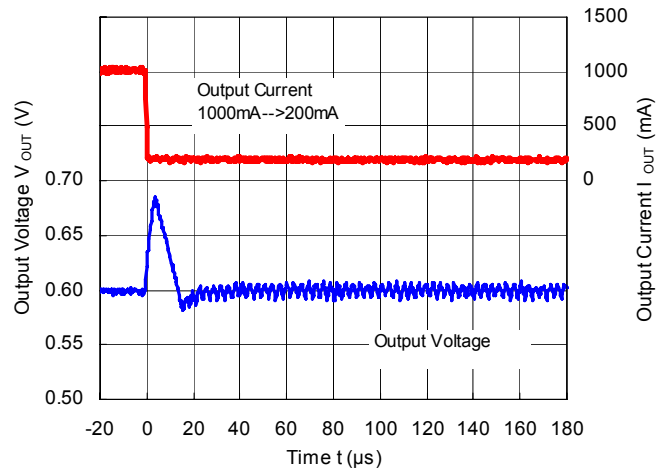

RP506Kxx1D/E/F ($V_{IN} = 3.6\text{ V}$, $V_{OUT} = 0.6\text{ V}$)
MODE = "H" Forced PWM Control

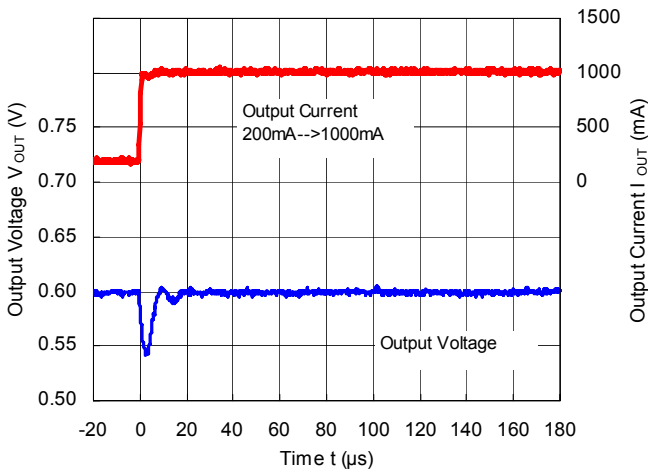

RP506Kxx1D/E/F ($V_{IN} = 3.6\text{ V}$, $V_{OUT} = 0.6\text{ V}$)
MODE = "H" Forced PWM Control

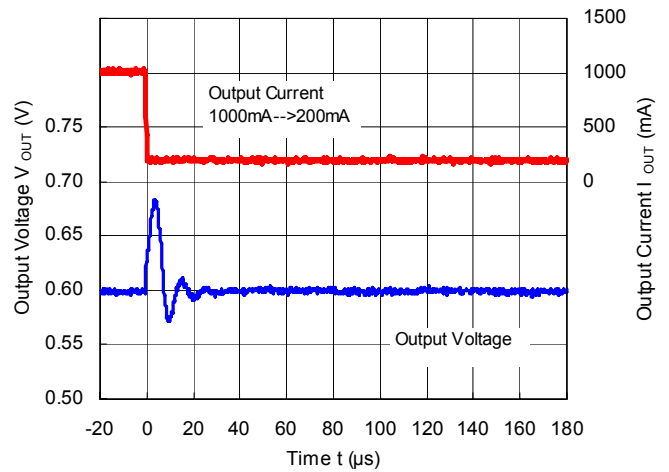

RP506Kxx1D/E/F ($V_{IN} = 3.6\text{ V}$, $V_{OUT} = 0.6\text{ V}$)

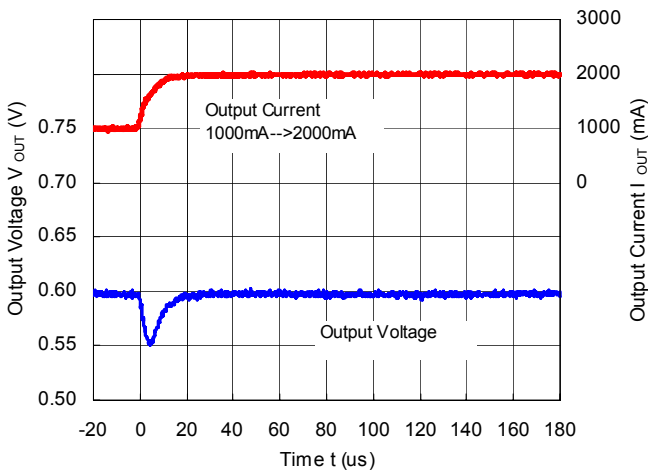

RP506Kxx1D/E/F ($V_{IN} = 3.6\text{ V}$, $V_{OUT} = 0.6\text{ V}$)

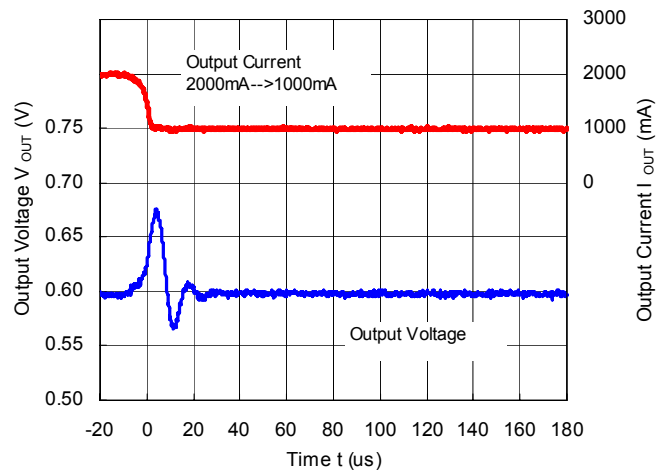

RP506Kxx1D/E/F ($V_{IN} = 3.6\text{ V}$, $V_{OUT} = 0.8\text{ V}$)
MODE = "L" PWM/VFM Auto Switching Control

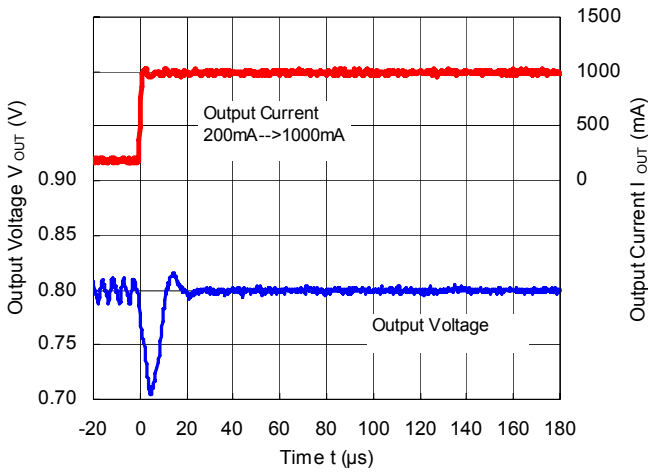

RP506Kxx1D/E/F ($V_{IN} = 3.6\text{ V}$, $V_{OUT} = 0.8\text{ V}$)
MODE = "L" PWM/VFM Auto Switching Control

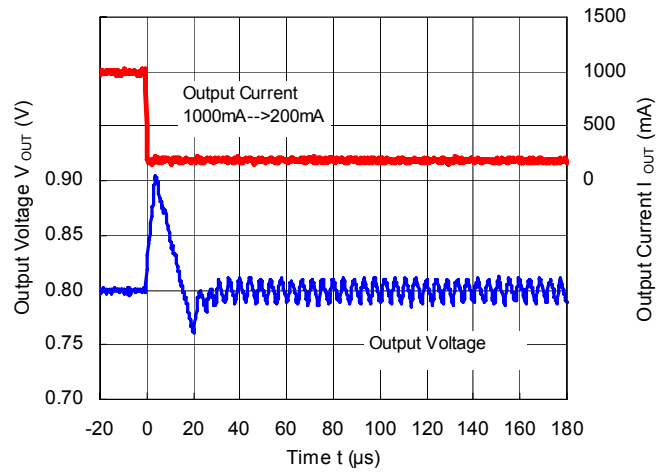

RP506Kxx1D/E/F ($V_{IN} = 3.6\text{ V}$, $V_{OUT} = 0.8\text{ V}$)
MODE = "H" Forced PWM Control

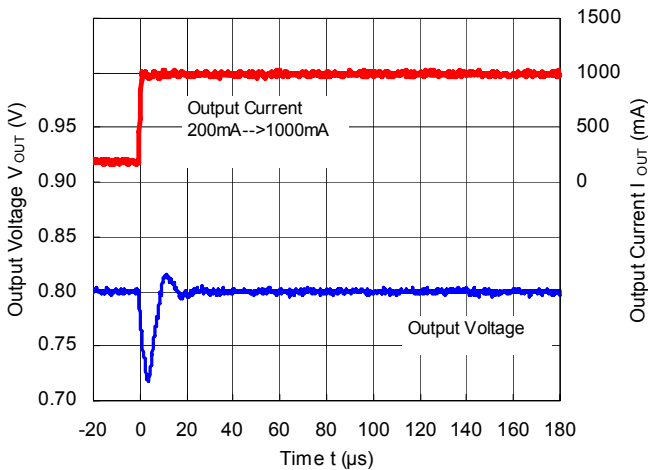

RP506Kxx1D/E/F ($V_{IN} = 3.6\text{ V}$, $V_{OUT} = 0.8\text{ V}$)
MODE = "H" Forced PWM Control

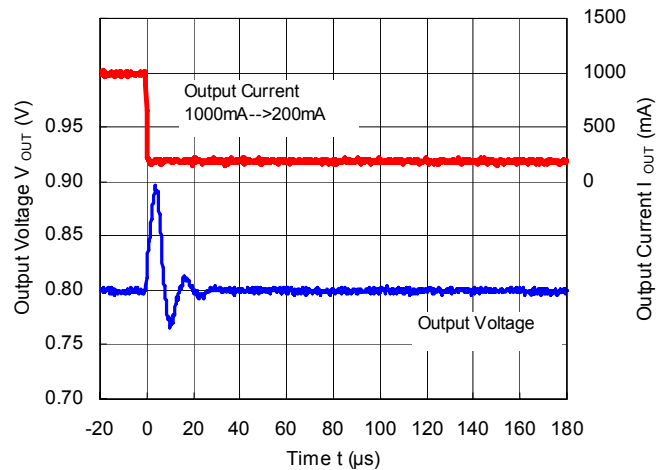

RP506Kxx1D/E/F ($V_{IN} = 3.6\text{ V}$, $V_{OUT} = 0.8\text{ V}$)

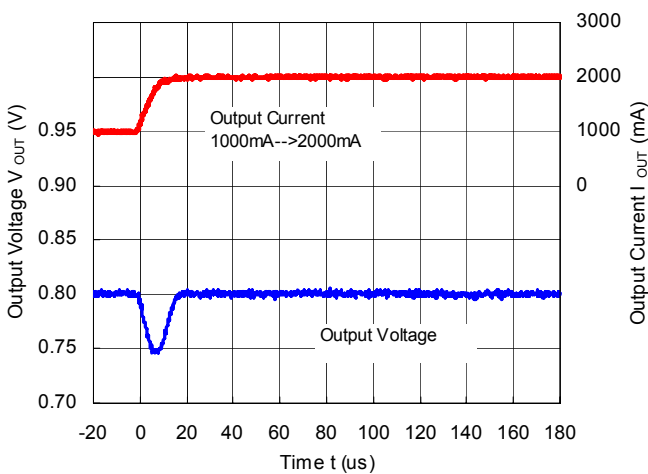

RP506Kxx1D/E/F ($V_{IN} = 3.6\text{ V}$, $V_{OUT} = 0.8\text{ V}$)

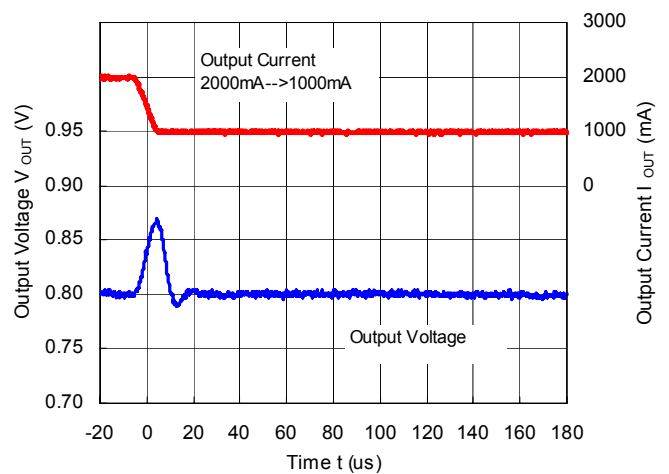

RP506Kxx1D/E/F ($V_{IN} = 3.6\text{ V}$, $V_{OUT} = 1.2\text{ V}$)
MODE = "L" PWM/VFM Auto Switching Control

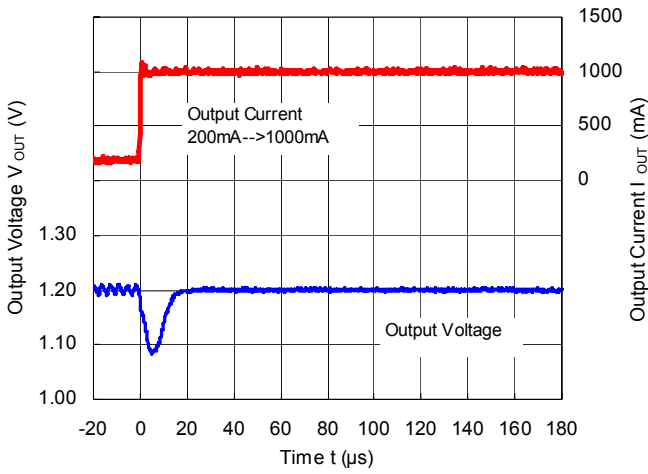

RP506Kxx1D/E/F ($V_{IN} = 3.6\text{ V}$, $V_{OUT} = 1.2\text{ V}$)
MODE = "L" PWM/VFM Auto Switching Control

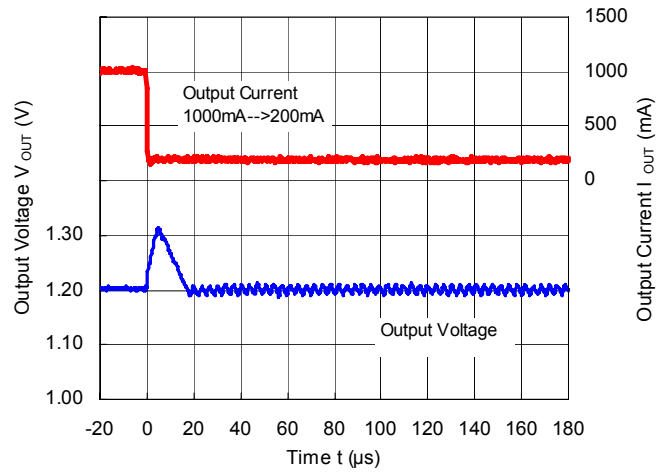

RP506Kxx1D/E/F ($V_{IN} = 3.6\text{ V}$, $V_{OUT} = 1.2\text{ V}$)
MODE = "H" Forced PWM Control

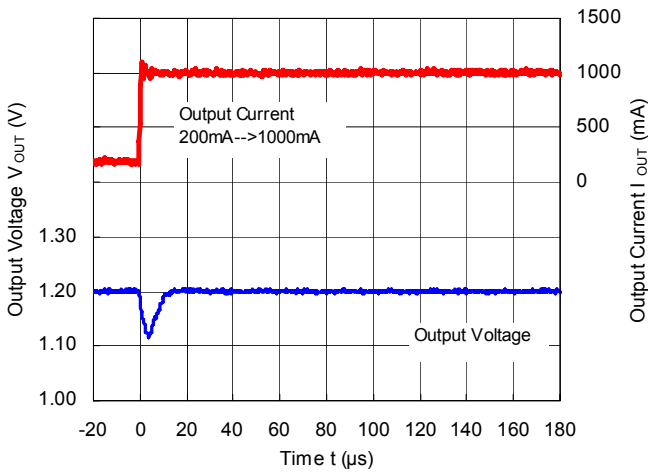

RP506Kxx1D/E/F ($V_{IN} = 3.6\text{ V}$, $V_{OUT} = 1.2\text{ V}$)
MODE = "H" Forced PWM Control

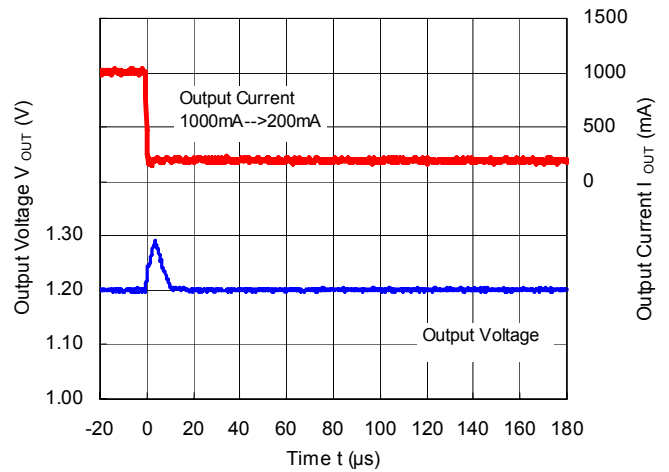

RP506Kxx1D/E/F ($V_{IN} = 3.6\text{ V}$, $V_{OUT} = 1.2\text{ V}$)

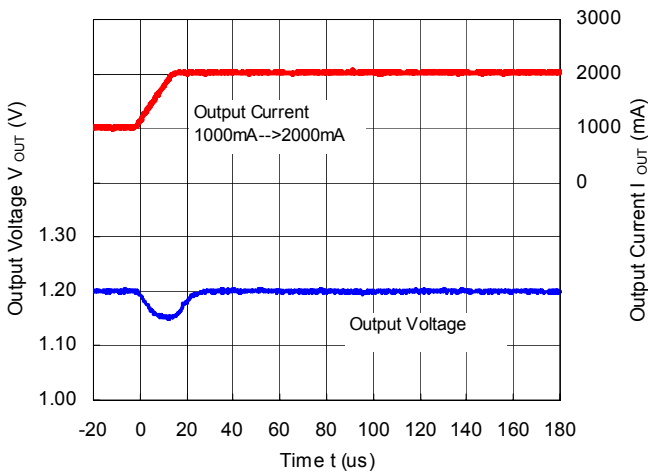

RP506Kxx1D/E/F ($V_{IN} = 3.6\text{ V}$, $V_{OUT} = 1.2\text{ V}$)

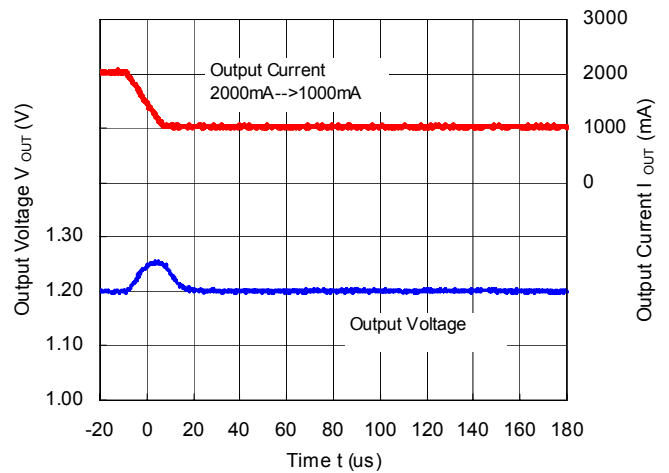

RP506Kxx1D/E/F ($V_{IN} = 3.6\text{ V}$, $V_{OUT} = 1.8\text{ V}$)
MODE = "L" PWM/VFM Auto Switching Control

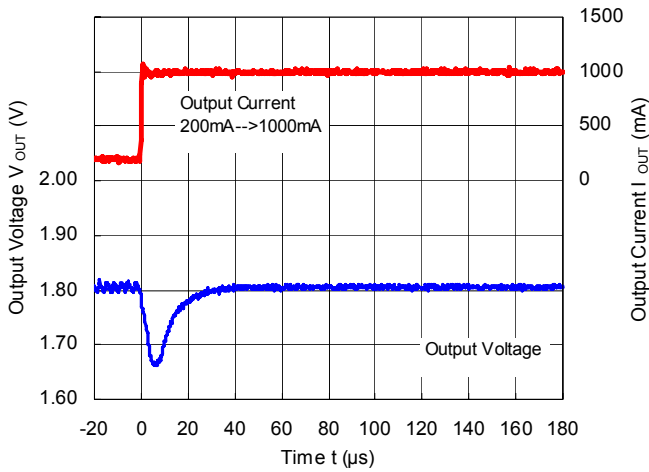

RP506Kxx1D/E/F ($V_{IN} = 3.6\text{ V}$, $V_{OUT} = 1.8\text{ V}$)
MODE = "L" PWM/VFM Auto Switching Control

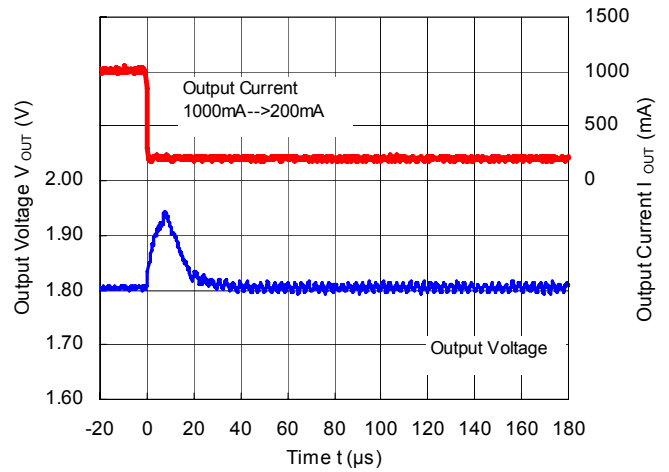

RP506Kxx1D/E/F ($V_{IN} = 3.6\text{ V}$, $V_{OUT} = 1.8\text{ V}$)
MODE = "H" Forced PWM Control

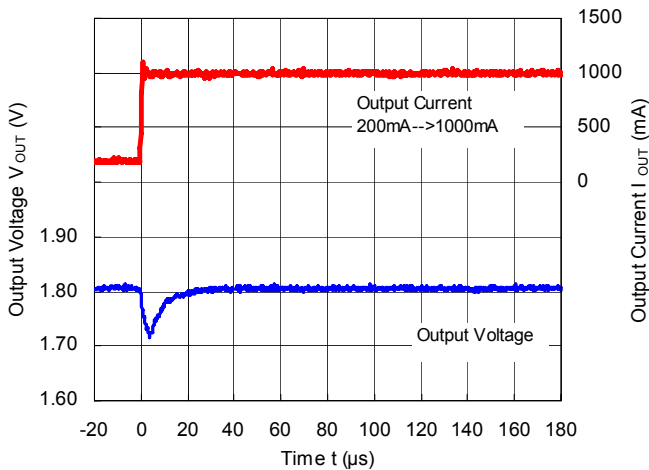

RP506Kxx1D/E/F ($V_{IN} = 3.6\text{ V}$, $V_{OUT} = 1.8\text{ V}$)
MODE = "H" Forced PWM Control

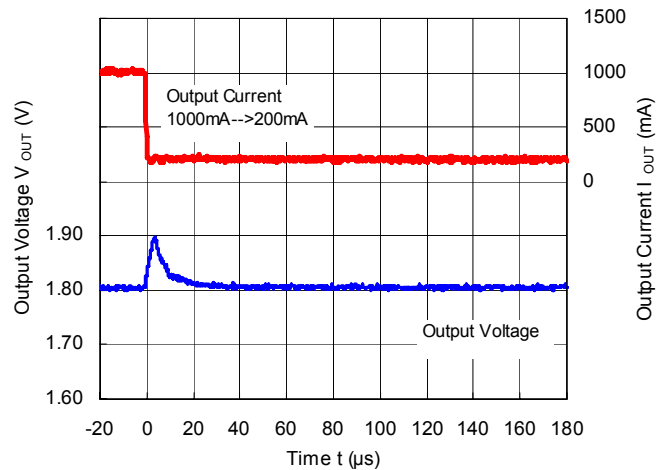

RP506Kxx1D/E/F ($V_{IN} = 3.6\text{ V}$, $V_{OUT} = 1.8\text{ V}$)

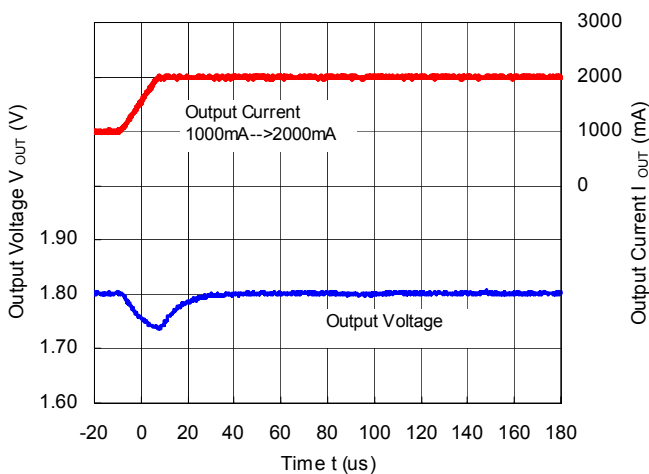

RP506Kxx1D/E/F ($V_{IN} = 3.6\text{ V}$, $V_{OUT} = 1.8\text{ V}$)

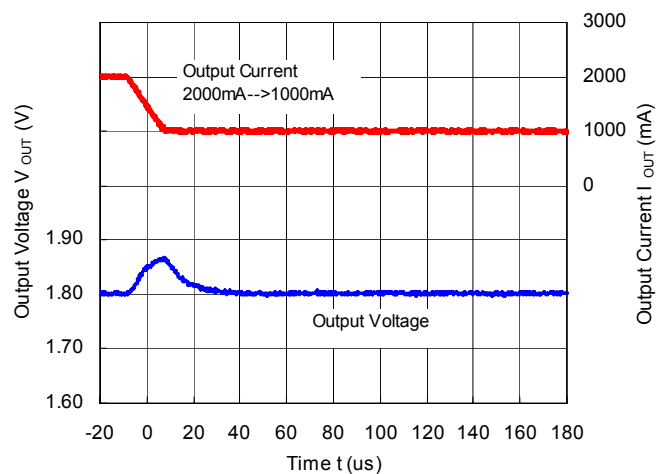

RP506Kxx1D/E/F ($V_{IN} = 5.0\text{ V}$, $V_{OUT} = 3.3\text{ V}$)
MODE = "L" PWM/VFM Auto Switching Control

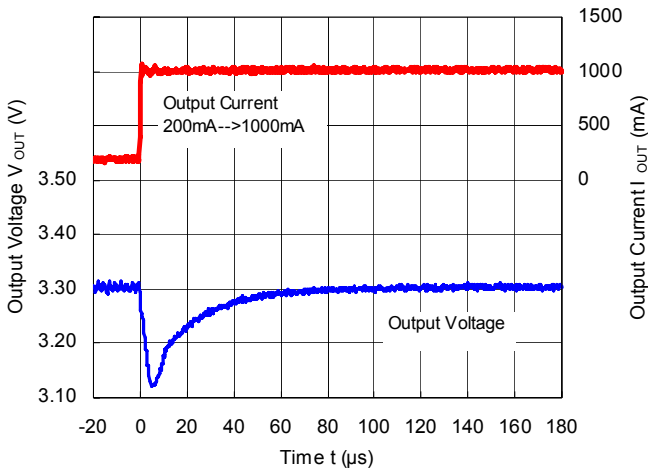

RP506Kxx1D/E/F ($V_{IN} = 5.0\text{ V}$, $V_{OUT} = 3.3\text{ V}$)
MODE = "L" PWM/VFM Auto Switching Control

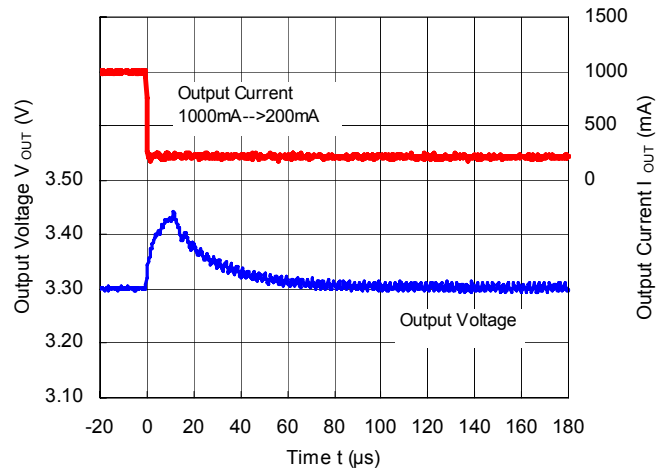

RP506Kxx1D/E/F ($V_{IN} = 5.0\text{ V}$, $V_{OUT} = 3.3\text{ V}$)
MODE = "H" Forced PWM Control

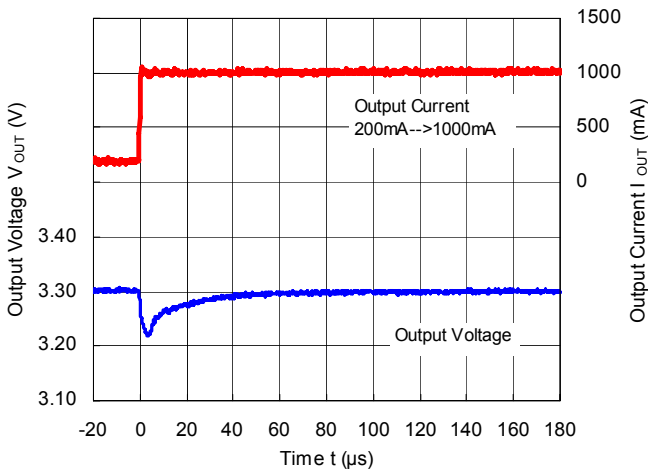

RP506Kxx1D/E/F ($V_{IN} = 5.0\text{ V}$, $V_{OUT} = 3.3\text{ V}$)
MODE = "H" Forced PWM Control

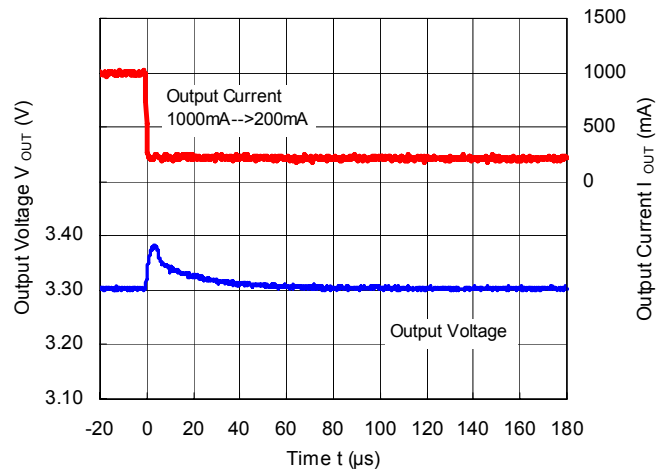

RP506Kxx1D/E/F ($V_{IN} = 5.0\text{ V}$, $V_{OUT} = 3.3\text{ V}$)

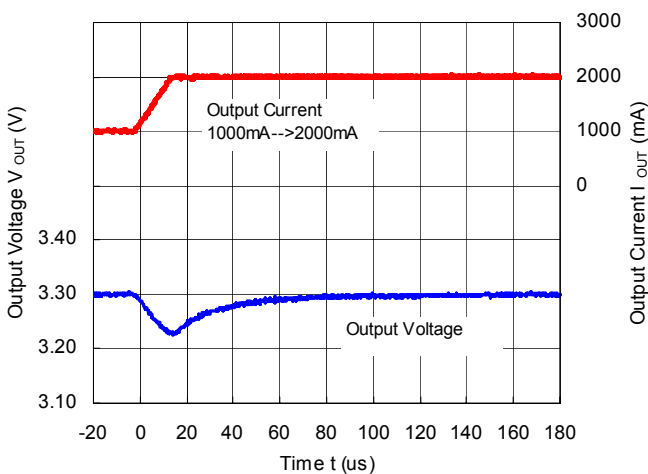

RP506Kxx1D/E/F ($V_{IN} = 5.0\text{ V}$, $V_{OUT} = 3.3\text{ V}$)

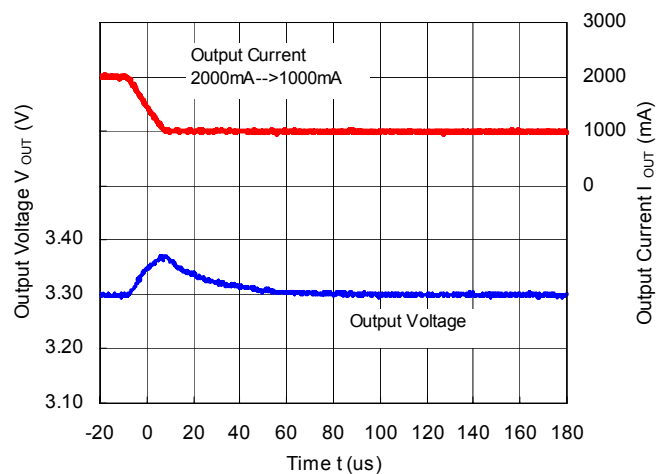

20) Auto Switching Control Waveform

RP506Kxx1A/B/C

($V_{IN} = 3.6\text{ V}$, $V_{OUT} = 1.2\text{ V}$, $I_{OUT} = 1\text{ mA}$)

MODE = "L" --> MODE = "H"

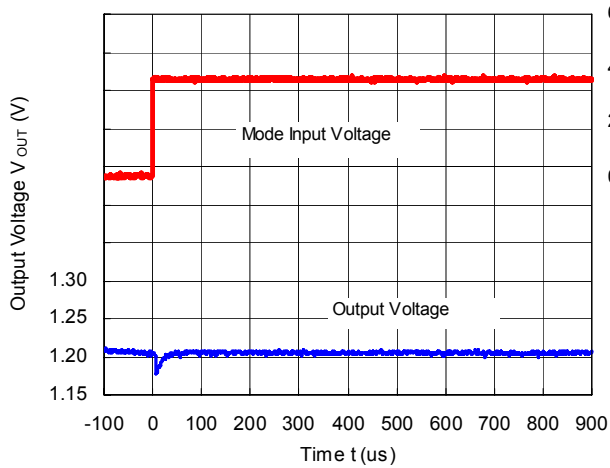

R P506Kxx1A/B/C

($V_{IN} = 3.6\text{ V}$, $V_{OUT} = 1.2\text{ V}$, $I_{OUT} = 1\text{ mA}$)

MODE = "H" --> MODE = "L"

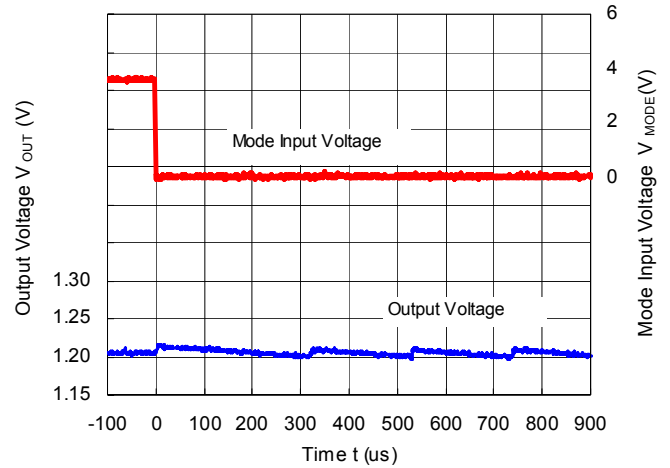

RP506Kxx1A/B/C

($V_{IN} = 3.6\text{ V}$, $V_{OUT} = 1.8\text{ V}$, $I_{OUT} = 1\text{ mA}$)

MODE = "L" --> MODE = "H"

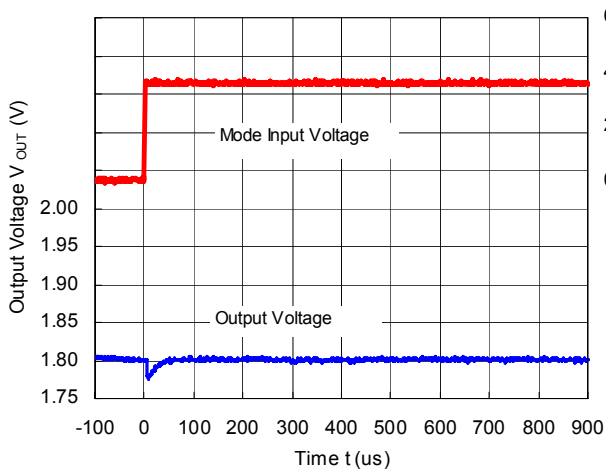

R P506Kxx1A/B/C

($V_{IN} = 3.6\text{ V}$, $V_{OUT} = 1.8\text{ V}$, $I_{OUT} = 1\text{ mA}$)

MODE = "H" --> MODE = "L"

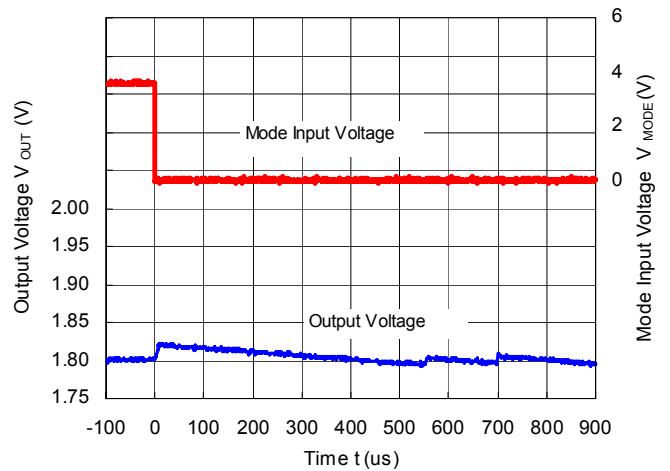

RP506Kxx1D/E/F

($V_{IN} = 3.6\text{ V}$, $V_{OUT} = 1.2\text{ V}$, $I_{OUT} = 1\text{ mA}$)

MODE = "L" --> MODE = "H"

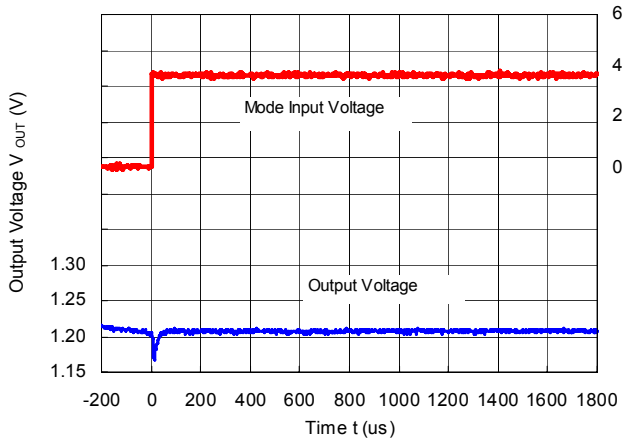

RP506Kxx1D/E/F

($V_{IN} = 3.6\text{ V}$, $V_{OUT} = 1.2\text{ V}$, $I_{OUT} = 1\text{ mA}$)

MODE = "H" --> MODE = "L"

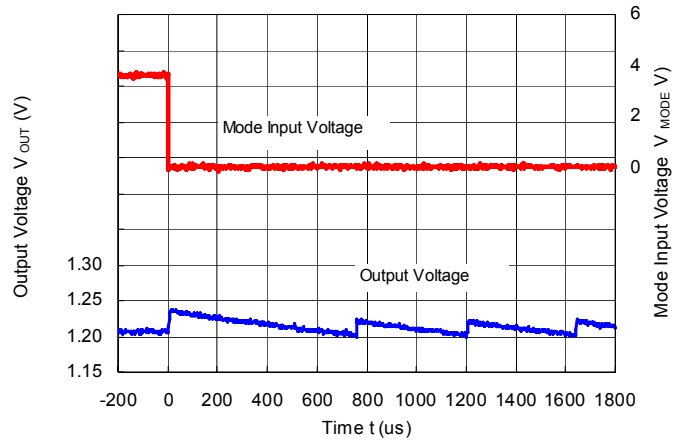

RP506Kxx1D/E/F

($V_{IN} = 3.6\text{ V}$, $V_{OUT} = 1.8\text{ V}$, $I_{OUT} = 1\text{ mA}$)

MODE = "L" --> MODE = "H"

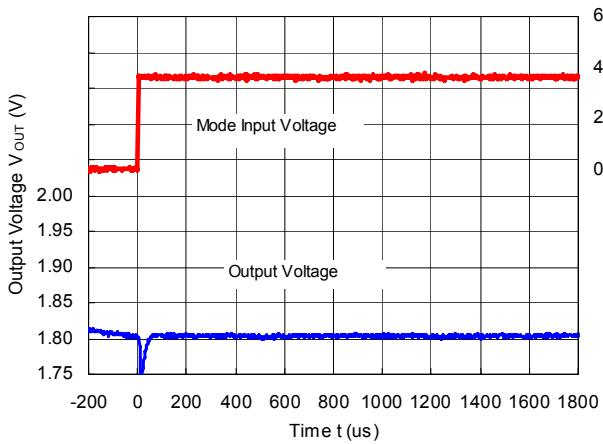

RP506Kxx1D/E/F

($V_{IN} = 3.6\text{ V}$, $V_{OUT} = 1.8\text{ V}$, $I_{OUT} = 1\text{ mA}$)

MODE = "H" --> MODE = "L"

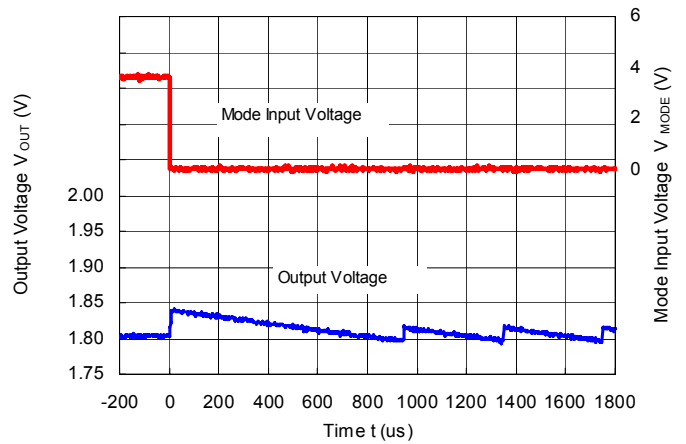



1. The products and the product specifications described in this document are subject to change or discontinuation of production without notice for reasons such as improvement. Therefore, before deciding to use the products, please refer to Ricoh sales representatives for the latest information thereon.
2. The materials in this document may not be copied or otherwise reproduced in whole or in part without prior written consent of Ricoh.
3. Please be sure to take any necessary formalities under relevant laws or regulations before exporting or otherwise taking out of your country the products or the technical information described herein.
4. The technical information described in this document shows typical characteristics of and example application circuits for the products. The release of such information is not to be construed as a warranty of or a grant of license under Ricoh's or any third party's intellectual property rights or any other rights.
5. The products listed in this document are intended and designed for use as general electronic components in standard applications (office equipment, telecommunication equipment, measuring instruments, consumer electronic products, amusement equipment etc.). Those customers intending to use a product in an application requiring extreme quality and reliability, for example, in a highly specific application where the failure or misoperation of the product could result in human injury or death (aircraft, spacevehicle, nuclear reactor control system, traffic control system, automotive and transportation equipment, combustion equipment, safety devices, life support system etc.) should first contact us.
6. We are making our continuous effort to improve the quality and reliability of our products, but semiconductor products are likely to fail with certain probability. In order to prevent any injury to persons or damages to property resulting from such failure, customers should be careful enough to incorporate safety measures in their design, such as redundancy feature, firecontainment feature and fail-safe feature. We do not assume any liability or responsibility for any loss or damage arising from misuse or inappropriate use of the products.
7. Anti-radiation design is not implemented in the products described in this document.
8. Please contact Ricoh sales representatives should you have any questions or comments concerning the products or the technical information.



For the conservation of the global environment, Ricoh is advancing the decrease of the negative environmental impact material.
After Apr. 1, 2006, we will ship out the lead free products only. Thus, all products that will be shipped from now on comply with RoHS Directive.
Basically after Apr. 1, 2012, we will ship out the Power Management ICs of the Halogen Free products only. (Ricoh Halogen Free products are also Antimony Free.)

RICOH RICOH COMPANY, LTD. Electronic Devices Company

<http://www.ricoh.com/LSI/>

RICOH COMPANY, LTD.

Electronic Devices Company

● Higashi-Shinagawa Office (International Sales)

3-32-3, Higashi-Shinagawa, Shinagawa-ku, Tokyo 140-8655, Japan
Phone: +81-3-5479-2857 Fax: +81-3-5479-0502

RICOH EUROPE (NETHERLANDS) B.V.

● Semiconductor Support Centre

"Nieuw Kronenburg" Prof. W.H. Keesomlaan 1, 1183 DJ, Amstelveen, The Netherlands
P.O.Box 114, 1180 AC Amstelveen
Phone: +31-20-5474-309 Fax: +31-20-5474-791

RICOH ELECTRONIC DEVICES KOREA Co., Ltd.

11 floor, Haesung 1 building, 942, Daechidong, Gangnamgu, Seoul, Korea
Phone: +82-2-2135-5700 Fax: +82-2-2135-5705

RICOH ELECTRONIC DEVICES SHANGHAI Co., Ltd.

Room403, No.2 Building, 690#Bi Bo Road, Pu Dong New district, Shanghai 201203,
People's Republic of China
Phone: +86-21-5027-3200 Fax: +86-21-5027-3299

RICOH COMPANY, LTD.

Electronic Devices Company

● Taipei office

Room109, 10F-1, No.51, Hengyang Rd., Taipei City, Taiwan (R.O.C.)
Phone: +886-2-2313-1621/1622 Fax: +886-2-2313-1623