

Features

- Glass Passivated Die Construction
- Ideally Suited for Automatic Assembly
- Low Forward Voltage Drop, High Efficiency
- Surge Overload Rating to 30A Peak
- Low Power Loss
- Fast Recovery Time
- Plastic Case Material has UL Flammability Classification Rating 94V-0

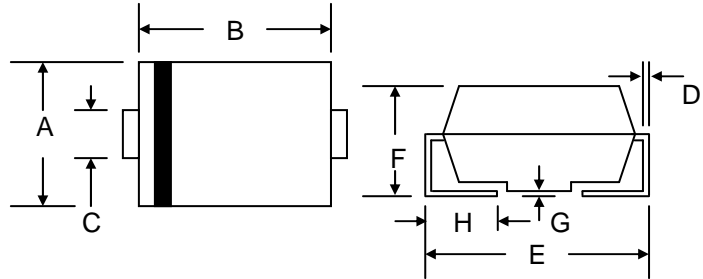

Mechanical Data

- Case: SMA/DO-214AC, Molded Plastic
- Terminals: Solder Plated, Solderable per MIL-STD-750, Method 2026
- Polarity: Cathode Band or Cathode Notch
- Marking: Type Number
- Weight: 0.064 grams (approx.)
- **Lead Free: For RoHS / Lead Free Version, Add "-LF" Suffix to Part Number, See Page 4**

SMA/DO-214AC		
Dim	Min	Max
A	2.29	2.92
B	4.00	4.60
C	1.27	1.90
D	0.152	0.305
E	4.80	5.30
F	2.00	2.44
G	0.051	0.203
H	0.76	1.52
All Dimensions in mm		

Maximum Ratings and Electrical Characteristics @ $T_A=25^\circ\text{C}$ unless otherwise specified

Single Phase, half wave, 60Hz, resistive or inductive load. For capacitive load, derate current by 20%.

Characteristic	Symbol	RS1A	RS1B	RS1D	RS1G	RS1J	RS1K	RS1M	Unit
Peak Repetitive Reverse Voltage	V_{RRM}	50	100	200	400	600	800	1000	V
Working Peak Reverse Voltage	V_{RWM}								
DC Blocking Voltage	V_R								
RMS Reverse Voltage	$V_{R(RMS)}$	35	70	140	280	420	560	700	V
Average Rectified Output Current @ $T_L = 90^\circ\text{C}$	I_O	1.0							A
Non-Repetitive Peak Forward Surge Current 8.3ms Single Half Sine-Wave Superimposed on Rated Load (JEDEC Method)	I_{FSM}	30							A
Forward Voltage @ $I_F = 1.0\text{A}$	V_{FM}	1.3							V
Peak Reverse Current @ $T_A = 25^\circ\text{C}$ At Rated DC Blocking Voltage @ $T_A = 125^\circ\text{C}$	I_{RM}	5.0 200							μA
Reverse Recovery Time (Note 1)	t_{rr}	150				250	500		nS
Typical Junction Capacitance (Note 2)	C_J	10							pF
Thermal Resistance Junction to Ambient (Note 3)	R_{JA}	105							$^\circ\text{C/W}$
Thermal Resistance Junction to Lead (Note 3)	R_{JL}	32							
Operating and Storage Temperature Range	T_J, T_{STG}	-55 to +150							$^\circ\text{C}$

- Note: 1. Measured with $I_F = 0.5\text{A}$, $I_R = 1.0\text{A}$, $I_{RR} = 0.25\text{A}$.
 2. Measured at 1.0 MHz and applied reverse voltage of 4.0 V DC.
 3. Mounted on PCB with 5.0mm x 5.0mm copper pads.

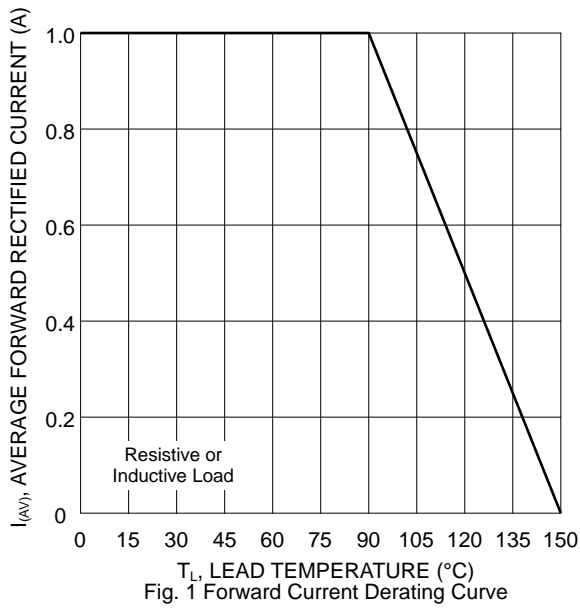

Fig. 1 Forward Current Derating Curve

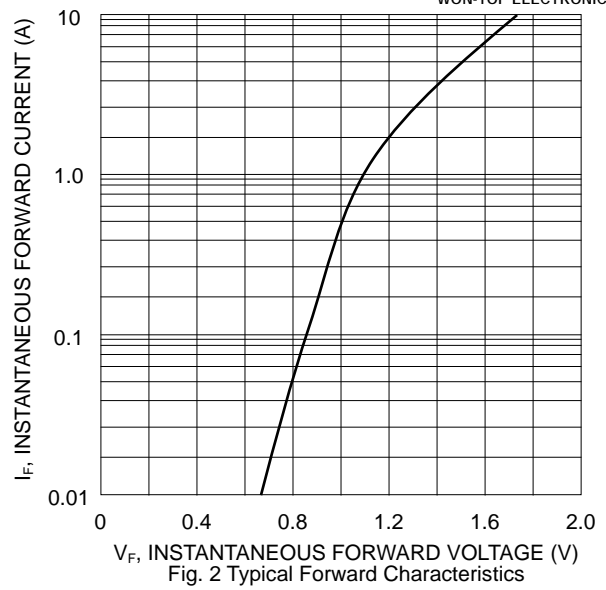

Fig. 2 Typical Forward Characteristics

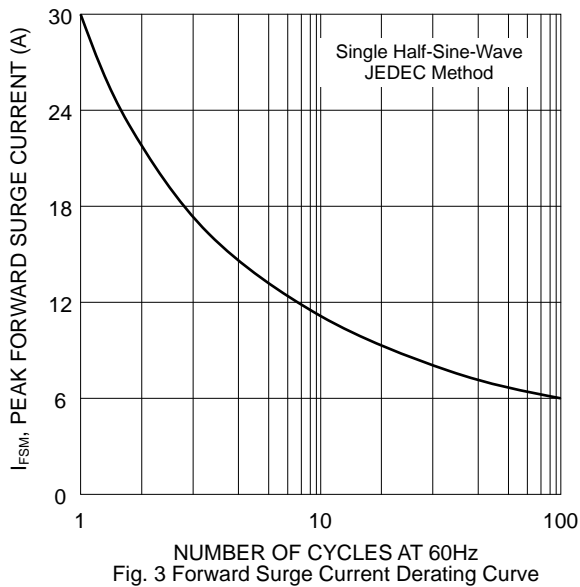

Fig. 3 Forward Surge Current Derating Curve

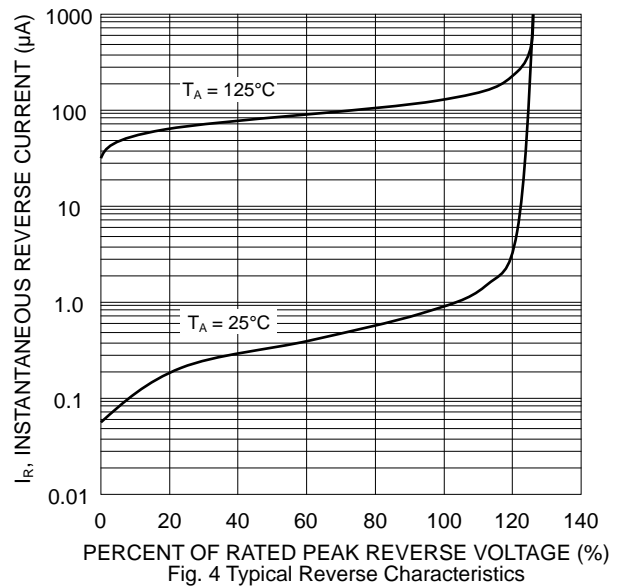

Fig. 4 Typical Reverse Characteristics

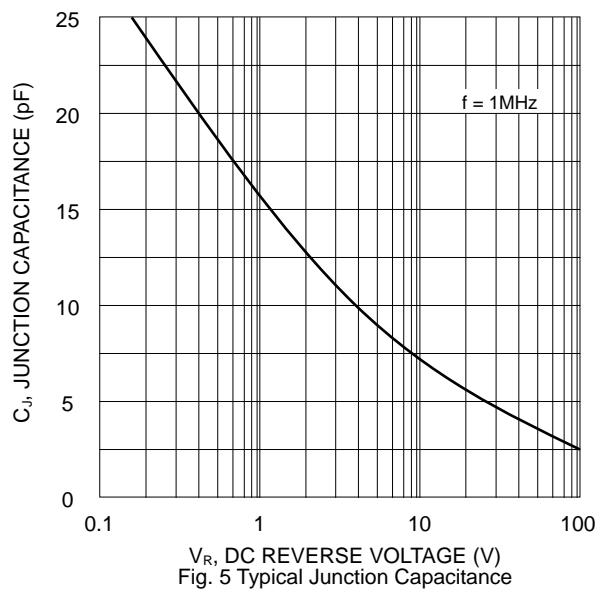
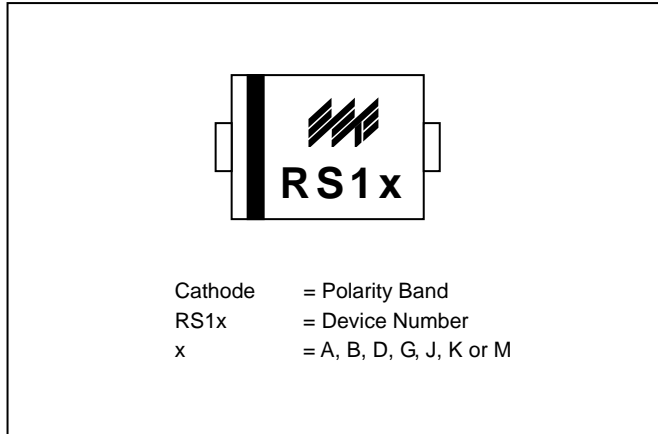
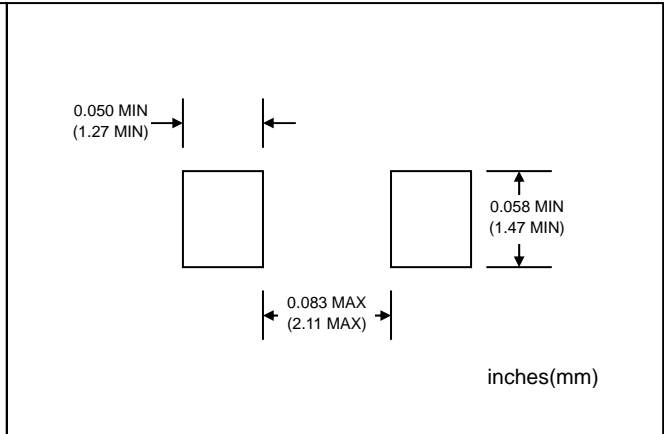

Fig. 5 Typical Junction Capacitance

MARKING INFORMATION



RECOMMENDED FOOTPRINT



PACKAGING INFORMATION

TAPE & REEL

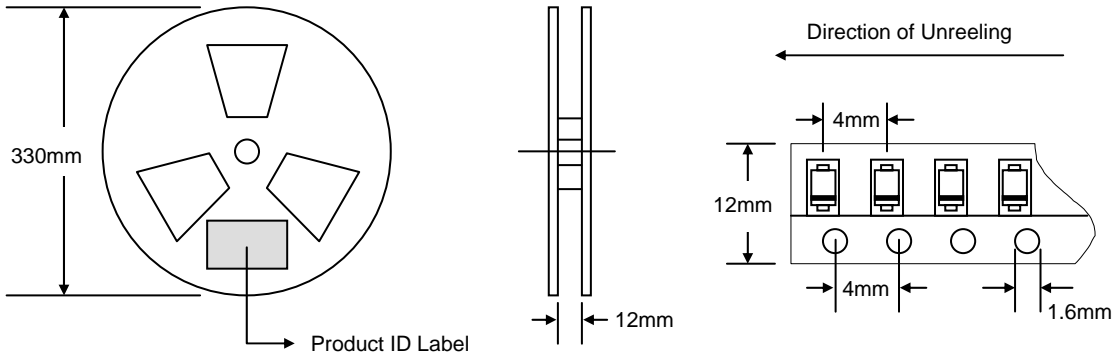

The diagrams show a top view of a 330mm diameter reel with a Product ID Label, a side view of the reel with a 12mm thickness, and a detailed view of the carrier tape. The carrier tape has a width of 12mm and a pitch of 4mm between components. The component width is 4mm and the lead length is 1.6mm. An arrow indicates the "Direction of Unreeling".

Reel Diameter (mm)	Quantity (PCS)	Inner Box Size L x W x H (mm)	Quantity (PCS)	Carton Size L x W x H (mm)	Quantity (PCS)	Approx. Gross Weight (KG)
330	5,000	340 x 337 x 45	10,000	370 x 370 x 420	80,000	14.0

Note: 1. Paper reel, white or gray color.
 2. Components are packed in accordance with EIA standard 481-1 and 481-2.

ORDERING INFORMATION

Product No.	Package Type	Shipping Quantity
RS1A-T3	SMA	5000/Tape & Reel
RS1B-T3	SMA	5000/Tape & Reel
RS1D-T3	SMA	5000/Tape & Reel
RS1G-T3	SMA	5000/Tape & Reel
RS1J-T3	SMA	5000/Tape & Reel
RS1K-T3	SMA	5000/Tape & Reel
RS1M-T3	SMA	5000/Tape & Reel

1. Shipping quantity given is for minimum packing quantity only. For minimum order quantity, please consult the Sales Department.
2. **To order RoHS / Lead Free version (with Lead Free finish), add "-LF" suffix to part number above. For example, RS1A-T3-LF.**

WON-TOP ELECTRONICS and  are registered trademarks of Won-Top Electronics Co., Ltd (WTE). WTE has checked all information carefully and believes it to be correct and accurate. However, WTE cannot assume any responsibility for inaccuracies. Furthermore, this information does not give the purchaser of semiconductor devices any license under patent rights to manufacturer. WTE reserves the right to change any or all information herein without further notice.

WARNING: DO NOT USE IN LIFE SUPPORT EQUIPMENT. WTE power semiconductor products are not authorized for use as critical components in life support devices or systems without the express written approval.

Won-Top Electronics Co., Ltd.

No. 44 Yu Kang North 3rd Road,

Chine Chen Dist., Kaohsiung 806, Taiwan

Phone: 886-7-822-5408 or 886-7-822-5410

Fax: 886-7-822-5417

Email: sales@wontop.com

Internet: <http://www.wontop.com>

We power your everyday.