



OKAYA

OKAYA Electric America, Inc.

SPECIFICATIONS

DRAWING CODE

SAMPLE CODE

(This Code will be changed while mass production)

MASS PRODUCTION CODE

RS800480T-7X0GP-A

Customer Approved

Date:

Sales Sign	QC Confirmed	Checked By	Designer

Approval For Specifications Only.

* This specification is subject to change without notice.

Approval For Specifications and Sample.



Phone: 219-477-4488
Fax: 219-477-4856
www.okaya.com

OKAYA ELECTRIC AMERICA
52 Marks Road, Suite 1
Valparaiso, Indiana 46383

Product Specification			
	RS800480T-7X0GP-A	Rev. No.	Issued Date.
		F	2010, OCT. 13
			Page.
			3 / 20

Contents

1.	General Description and Features	4
1.1	Features	4
1.2	LCD Module	4
2.	Mechanical Information	4
3.	Electrical Specifications	5
3.1	Absolute Max. Ratings	5
3.2	AC Timing Characteristic of The LCD	8
3.3	Back-Light Unit	10
4.	Optical Characteristics	11
4.1	Optical characteristic of the LCD	11
5.	I/O Terminal	14
5.1	Pin Assignment	14
5.2	Touch Panel Unit	15
5.3	Back Light Unit	15
5.4	Block Diagram	16
6.	Displayed Color and Input Data	17
7.	Touch Screen Panel Specifications	18
7.1	Touch Panel	18
8.	Reliability Condition	19
9.	Dimensional Outlines	20

Product Specification				
	RS800480T-7X0GP-A	Rev. No.	Issued Date.	Page.
		F	2010, OCT. 13	4 / 20

1. General Description and Features

RS800480T-7X0GP-Aa transmissive type color active matrix TFT (Thin Film Transistor) liquid crystal display (LCD) that uses amorphous silicon TFT as a switching device. This model is composed of a TFT-LCD module, a driver circuit, touch Panel and a back-light unit. Graphics and texts can be displayed on a WVGA 800 (W) x 3 x 480 (H) dots (16:9 aspect ratio) with 262,144 colors by supplying 18 bits data signal (6bits/each color). The following table described the features

1.1 Features

- Transmissive and back-light with 27 LEDs are available.
- TN (Twisted Nematic) mode.
- Digital RGB (6bits/color) data transfer.
- Data enable mode.

1.2 LCD Module

Item	Specification	Unit
Screen Size	7.0 inches	Diagonal
Display Resolution	800 (H) x 480 (V)	Pixel
Active Area	153.6 (H) x 86.64 (V)	mm
Outline Dimension	165.00 (H) x 104.00 (V) x 6.5 (T)	mm
Display Mode	Normally white mode/ Transmissive	--
Pixel Arrangement	R,G,B Vertical Stripe	--
Pixel Size	192 x 180.5	um
Display Color	262k	--
Viewing Direction	6 o'clock	--
Input Interface	Digital RGB (6bits/color) Data Transfer	--

2. Mechanical Information

Item	Min.	Typ.	Max.	Unit	Note	
Module Size	Horizontal (H)	--	165.00	--	mm	
	Vertical (V)	--	104.00	--	mm	
	Thickness (T)	--	6.5	--	mm	(1)
	Thickness (T)	--	8.0	--	mm	(2)
Weight	--	(161)	--	g	--	

Note (1) Not Include Component. Refer to the Outline Dimension Drawing as attached.

(2) Include Component. Refer to the Outline Dimension Drawing as attached.

Product Specification				
	RS800480T-7X0GP-A	Rev. No.	Issued Date.	Page.
		F	2010, OCT. 13	5 / 20

3. Electrical Specifications

3.1 Absolute Max. Ratings

3.1.1 Absolute Ratings of Environment

If the operating condition exceeds the following absolute maximum ratings, the TFT LCD module may be damaged permanently.

($T_a=25\pm 2^\circ\text{C}$, $V_{SS}=\text{GND}=0$)

Item	Symbol	Min.	Max.	Unit	Note
Storage temperature	T_{STG}	-20	70	$^\circ\text{C}$	(1)
Operating temperature	T_{OPR}	-10	60	$^\circ\text{C}$	(1,2,3)

Note (1) 95 % RH Max. ($40^\circ\text{C} \geq T_a$). Maximum wet-bulb temperature at 39°C or less. ($T_a > 40^\circ\text{C}$) No condensation.

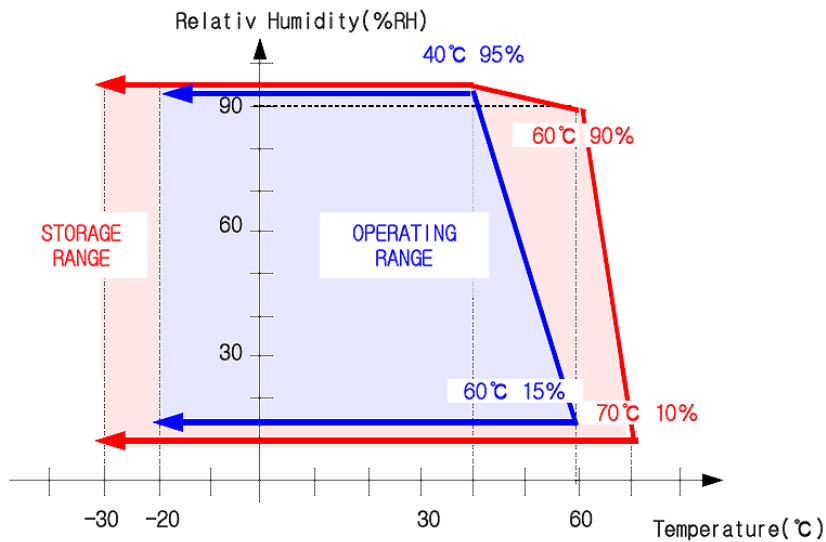

Note (2) In case of below 0° , the response time of liquid crystal (LC) becomes slower and the color of panel becomes darker than normal one. Level of retardation depends on temperature, because of LC's character

Note (3) Only operation is guaranteed at operating temperature. Contrast, response time, another display quality are evaluated at $+25^\circ\text{C}$.

Product Specification



RS800480T-7X0GP-A

Rev. No.

Issued Date.

Page.

F

2010, OCT. 13

6 / 20

3.1.2 Electrical Absolute Maximum Ratings

($V_{SS}=GND=0$)

Parameter	Symbol	Min.	Max.	Unit	Remark
Power supply voltage	V_{CC}	-0.3	6.0	V	
Signal input voltage	R0-R5,G0-G5, B0-B5,DCLK,DE	-0.3	$V_{CC}+0.3$	V	--
Permissive input ripple voltage	V_{RF}	--	100	mVp-p	$V_{CC}=+3.0V$

Display On/Off Sequence :

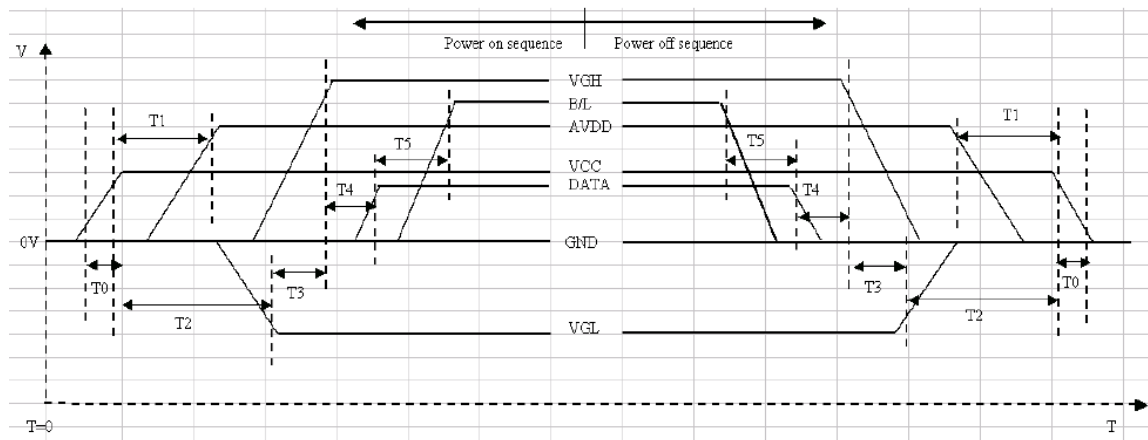

Item	Min.	Typ.	Max.	Unit
T0	0.5	--	20	msec
T1	16			msec
T2	20			msec
T3	10			msec
T4	10		50	msec
T5	50			msec

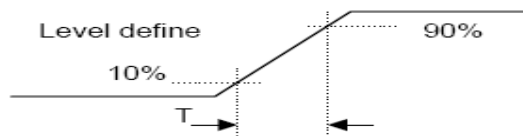

Power On Sequence: VCC-> AVDD -> VGL -> VGH -> Data -> B/L

Power Off Sequence: B/L-> Data -> VGH -> VGL -> AVDD -> VCC

Product Specification

	RS800480T-7X0GP-A	Rev. No.	Issued Date.	Page.
		F	2010, OCT. 13	7 / 20

3.1.3 DC Electrical Characteristics of the TFT LCD

(Ta=25±2°C, V_{SS}=GND=0)

Item	Symbol	Min.	Typ.	Max.	Unit	Remark	
Power supply	VCC	2.7	3.0	3.5	V		
Input Voltage for logic	H Level	V _{IH}	0.7xVCC	-	VCC	V	
	L Level	V _{IL}	0	-	0.3xVCC	V	
Power Supply current	ICC	-	(170)	-	mA	Note 1	

Note1: f_v =60Hz , Ta=25°C , Display pattern : Black pattern

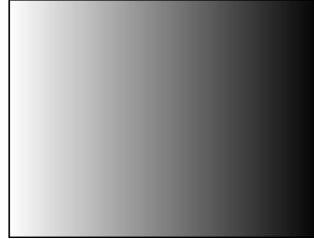

Product Specification

	RS800480T-7X0GP-A	Rev. No.	Issued Date.	Page.
		F	2010, OCT. 13	8 / 20

3.2 AC Timing Characteristic of The LCD

3.2.1 Timing Condition (DE only mode)

Signal	Parameter	Symbol	Min.	Typ.	Max.	Unit.	Remark
DCLK	DCLK cycle time	T_{cph}	25	-	-	ns	
	DCLK Frequency	f_{clk}	-	30	40	MHz	
	DCLK High plus width	T_{cwh}	40	50	60	%	
Horizontal	HSD setup time	T_{hst}	8	-	-	ns	
	HSD hold time	T_{hhd}	8	-	-	ns	
	Horizontal display area	t_{hd}	-	800	-	Tcph	
	HSD period time	t_h	-	928	-	Tcph	
	HSD pulse width	t_{hpw}	1	48	-	Tcph	
	HSD back porch	t_{hb}	-	40	-	Tcph	
	HSD front porch	t_{hfp}	-	40	-	Tcph	
Vertical	VSD setup time	T_{vst}	8	-	-	ns	
	VSD hold time	T_{vhd}	8	-	-	ns	
	Vertical display area	t_{vd}	-	480	-	th	
	VSD period time	t_v	-	525	-	th	
	VSD pulse width	t_{vpw}	-	3	-	th	
	VSD back porch	t_{vb}	-	29	-	th	
	VSD front porch	t_{vfp}	-	13	-	th	
DE	DE setup time	T_{esu}	8	-	-	ns	
	DE hold time	T_{ehd}	8	-	-	ns	
DATA	Data setup time	T_{dsu}	8	-	-	ns	
	Data hold time	T_{dhd}	8	-	-	ns	

Product Specification



RS800480T-7X0GP-A

Rev. No.

Issued Date.

Page.

F

2010, OCT. 13

9 / 20

3.2.2 Timing Characteristic

3.2.2.1 DE and RGB Input Timing

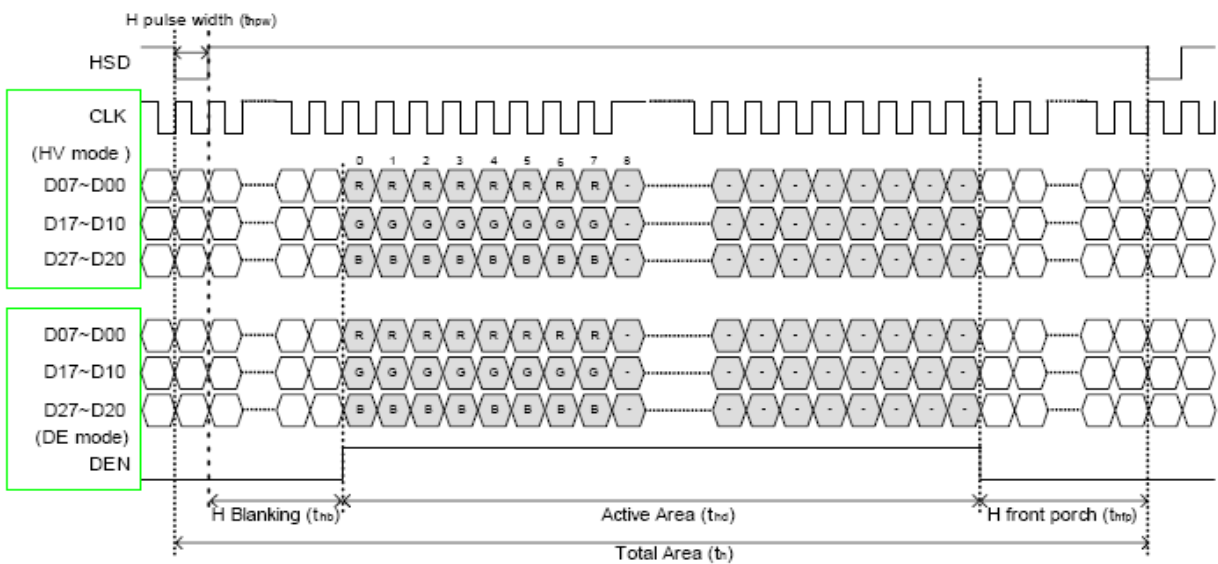
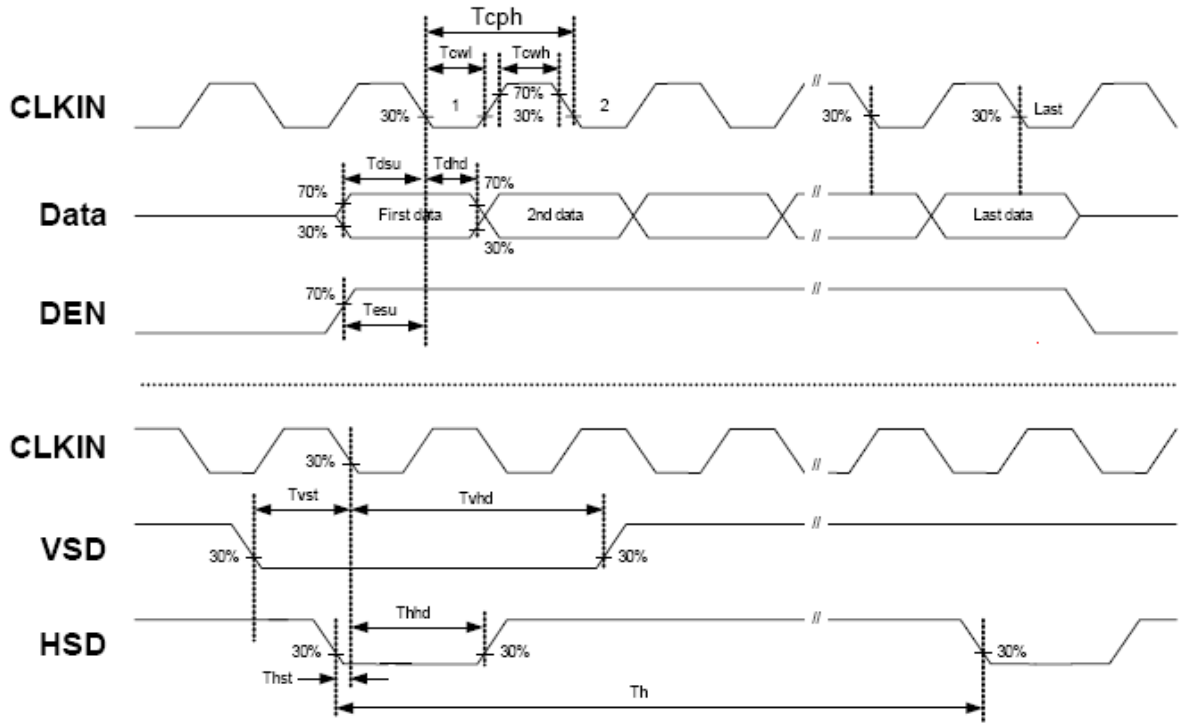

Product Specification

	RS800480T-7X0GP-A	Rev. No.	Issued Date.	Page.
		F	2010, OCT. 13	10 / 20

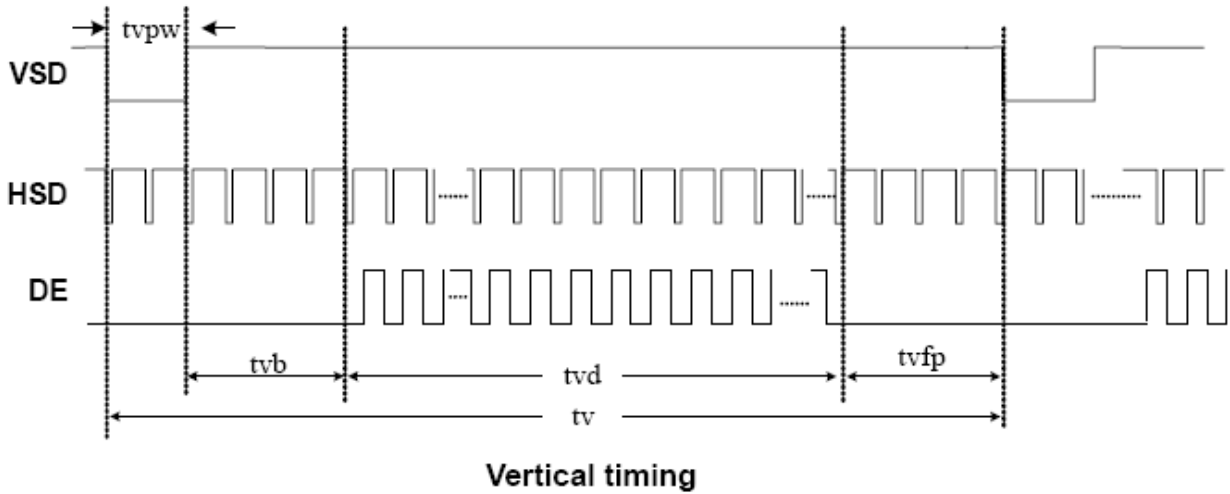

3.3 Back-Light Unit

The Back-light system is an edge-lighting type with 27 white LED (Light Emitting Diode)s. The characteristics of 27 white LEDs are shown in the following tables.

(Ta= Room Temp)

Characteristics	Symbol	Min.	Typ.	Max.	Unit	Note
Forward Voltage	V_f	(9.3)	(9.9)	(10.5)	V	
Forward Current	I_f	-	180	-	mA	(1)
Power Consumption	P_{BL}	-	1782	-	mW	(2)
LED Life time	-	(20000)	-	-	hr	(3)

Note (1) LEDs in 3 series x 9 parallel type.

(2) Where $I_f = 180\text{mA}$, $V_f = 9.9$, $P_{BL} = V_f \times I_f$

(3) The environmental conducted under ambient air flow ,at $T_a=25\pm 2^\circ\text{C}$, $60\%\text{RH}\pm 5\%$

Product Specification

	RS800480T-7X0GP-A	Rev. No.	Issued Date.	Page.
		F	2010, OCT. 13	11 / 20

4. Optical Characteristics

4.1 Optical characteristic of the LCD

The following items are measured under stable conditions. The optical characteristics should be measured in a dark room or equivalent state with the methods.

Measuring equipment: BM-7A

Item	Symbol	Condition	Min	Type	Max	Unit	Note	
Brightness	B		(240)	(280)	--	cd/m ²		
Response time	T _r	θ=0°	-	5	7	ms	.	
	T _f		--	20	28	ms		
Contrast ratio	CR	At optimized viewing angle	(400)	(500)	--	--		
Color Gamut	NTSC %	--	--	(45)	--	%		
Luminance Uniformity	ΔL		70	80		%		
Color Chromaticity (CIE 1931)	White	W _x	θ=0° Normal Viewing Angle	(0.280)	(0.310)	(0.340)	--	BM-7A
		W _y		(0.330)	(0.360)	(0.390)		
Viewing Angle (6H)	Hor.	θ _R	CR≥10	60	70	--	Degree	
		θ _L		60	70	--		
	Ver.	θ _U		40	50	--		
		θ _D		50	60	--		

Product Specification

	RS800480T-7X0GP-A	Rev. No.	Issued Date.	Page.
		F	2010, OCT. 13	12 / 20

a. Test equipment setup

After stabilizing and leaving the panel alone shall be warmed up for the stable operation of LCM, the measurement should be executed. Measurement should be executed in a stable, windless, and dark room. Optical specifications are measured by Topcon BM-7(fast) with a viewing angle of 2° at a distance of 50cm and normal direction.

b. Definition of response time: Tr and Tf

The response time is defined as the following figure and shall be measured by switching the input signal for "black" and "white".

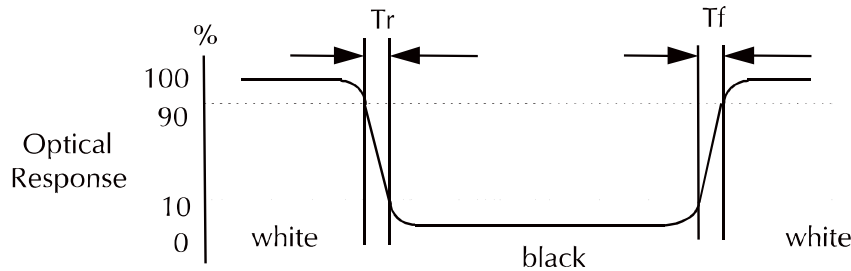

c. Definition of contrast ratio:

$$\text{Contrast Ratio (CR)} = \frac{\text{Brightness measured when LCD is at "white state"}}{\text{Brightness measured when LCD is at "black state"}}$$

d. Measured at the center area of the panel when all the input terminals of LCD panel are electrically opened.

Product Specification

	RS800480T-7X0GP-A	Rev. No.	Issued Date.	Page.
		F	2010, OCT. 13	13 / 20

e. View Angle

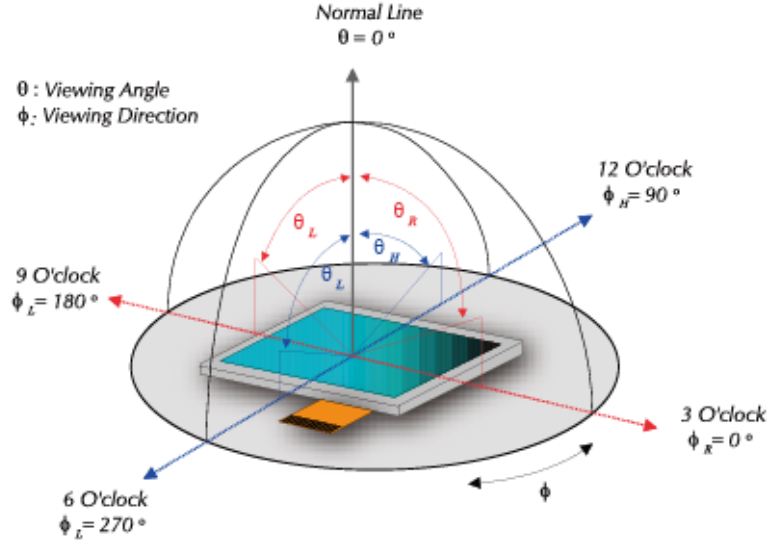

f. Definition of Luminance of White: Luminance of white at the center points

Light Source of Back-Light Unit	LED Type
---------------------------------	----------

g. Definition of White Uniformity

$$\text{White Uniformity} = \frac{\text{Min. luminance of white among 9-points}}{\text{Max. luminance of white among 9-points}} \times 100\%$$

h. The definition of Color Gamut -Color Chromaticity CIE 1931

Color coordinate of white & red, green, blue at center point.

Color Gamut : NTSC(%) = (RGB Triangle Area / NTSC Triangle Area) x 100

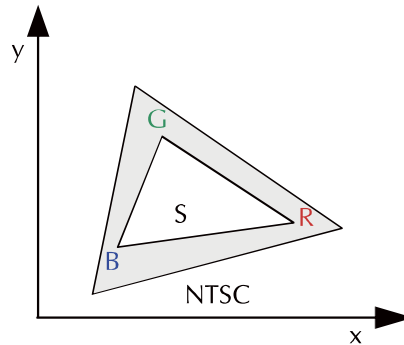

Product Specification				
	RS800480T-7X0GP-A	Rev. No.	Issued Date.	Page.
		F	2010, OCT. 13	14 / 20

5. I/O Terminal

5.1 Pin Assignment

Pin No.	Symbol	I/O	Function	Remark
1	GND	P	Ground	
2	GND	P	Ground	
3	NC	-	No Connection	
4	VCC	P	Power Supply	
5	VCC	P	Power Supply	
6	VCC	P	Power Supply	
7	VCC	P	Power Supply	
8	VCC	P	Power Supply	
9	DE	I	Data Enable Timing Signal	
10	GND	P	Ground	
11	GND	P	Ground	
12	GND	P	Ground	
13	B5	I	Blue data signal (MSB)	
14	B4	I	Blue data signal	
15	B3	I	Blue data signal	
16	GND	P	Ground	
17	B2	I	Blue data signal	
18	B1	I	Blue data signal	
19	B0	I	Blue data signal (LSB)	
20	GND	P	Ground	
21	G5	I	Green data signal (MSB)	
22	G4	I	Green data signal	
23	G3	I	Green data signal	
24	GND	P	Ground	
25	G2	I	Green data signal	
26	G1	I	Green data signal	
27	G0	I	Green data signal (LSB)	
28	GND	P	Ground	
29	R5	I	Red data signal (MSB)	
30	R4	I	Red data signal	
31	R3	I	Red data signal	
32	GND	P	Ground	
33	R2	I	Red data signal	
34	R1	I	Red data signal	
35	R0	I	Red data signal (LSB)	

Product Specification

	RS800480T-7X0GP-A	Rev. No.	Issued Date.	Page.
		F	2010, OCT. 13	15 / 20

36	GND	P	Ground	
37	GND	P	Ground	
38	DCLK	I	Data Clock	
39	GND	P	Ground	
40	GND	P	Ground	

I: Input, O: Output, P: Power

Remarks:

- 1) NC Pin must be retained; this pin can't contact GND or other signal.
- 2) GND Pin must ground contact, can not be floating.
- 3) Connector Part No: FH12-40S-0.5SH or equivalent.

5.2 Touch Panel Unit

Pin No.	Symbol	Function	Remark
1	Y2	Touch Panel Up	
2	X2	Touch Panel Right	
3	Y1	Touch Panel Down	
4	X1	Touch Panel Left	

Notes: Connector Part No: CVILUX CF25041D0R0-10 or equivalent.

5.3 Back Light Unit

Pin No.	Symbol	Function	Remark
1	LEDA	Power Supply for LED backlight	RED
2	LEDK	GND for LED backlight	BLACK

Notes: Connector Part No: JST:BHSR-02VS-01 or equivalent.

Product Specification

	RS800480T-7X0GP-A	Rev. No.	Issued Date.	Page.
		F	2010, OCT. 13	16 / 20

5.4 Block Diagram

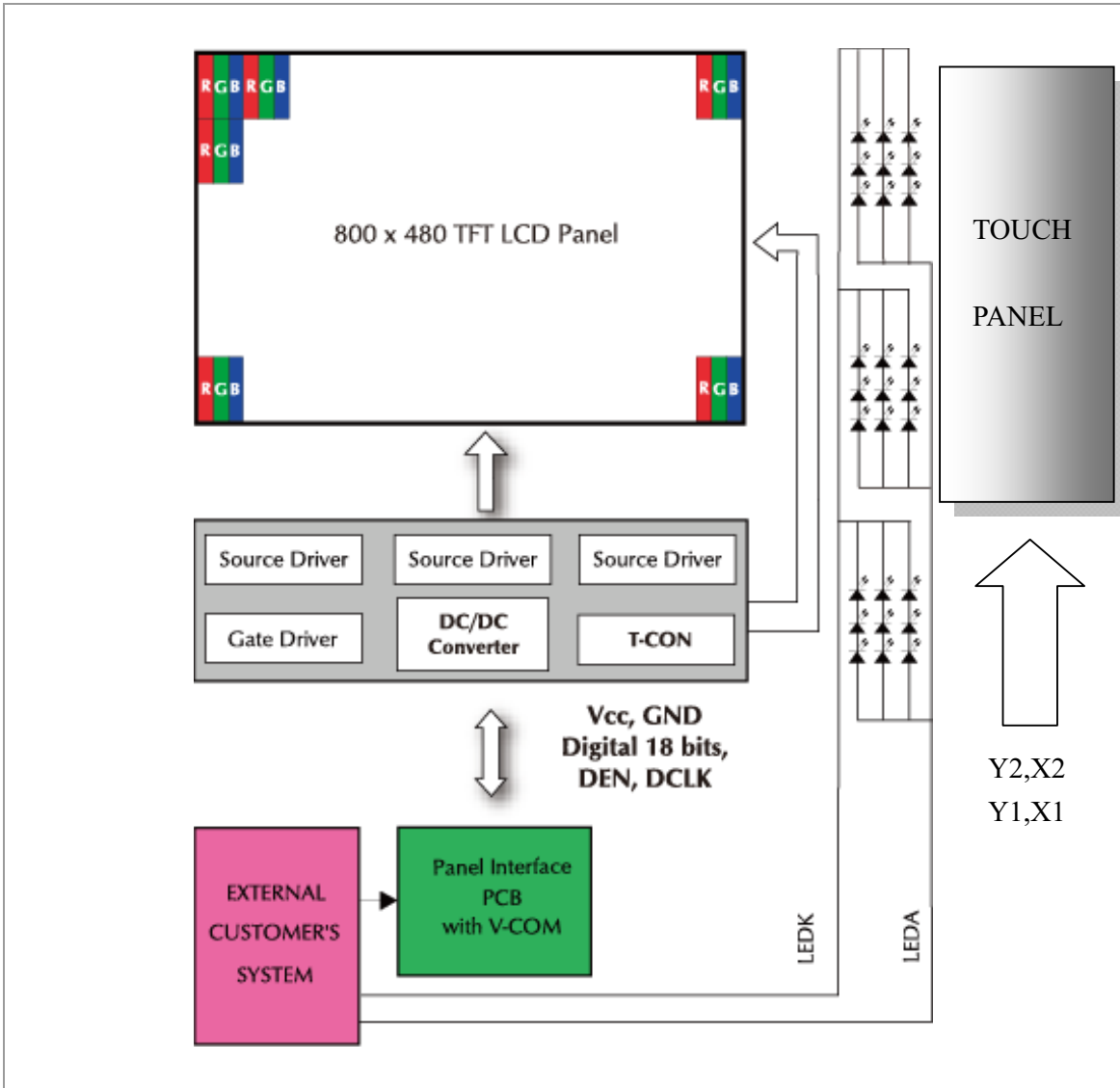

Product Specification

	RS800480T-7X0GP-A	Rev. No.	Issued Date.	Page.
		F	2010, OCT. 13	17 / 20

6. Displayed Color and Input Data

	Color & Gray Scale	Data Signal																	
		R5	R4	R3	R2	R1	R0	G5	G4	G3	G2	G1	G0	B5	B4	B3	B2	B1	B0
Basic Color	Black	0	0	0	0	0	0	0	0	0	0	0	0	0	0	0	0	0	0
	Red(0)	1	1	1	1	1	1	0	0	0	0	0	0	0	0	0	0	0	0
	Green(0)	0	0	0	0	0	0	1	1	1	1	1	1	0	0	0	0	0	0
	Blue(0)	0	0	0	0	0	0	0	0	0	0	0	0	1	1	1	1	1	1
	Cyan	0	0	0	0	0	0	1	1	1	1	1	1	1	1	1	1	1	1
	Magenta	1	1	1	1	1	1	0	0	0	0	0	0	1	1	1	1	1	1
	Yellow	1	1	1	1	1	1	1	1	1	1	1	1	0	0	0	0	0	0
	White	1	1	1	1	1	1	1	1	1	1	1	1	1	1	1	1	1	1
Red	Black	0	0	0	0	0	0	0	0	0	0	0	0	0	0	0	0	0	0
	Red(62)	0	0	0	0	0	1	0	0	0	0	0	0	0	0	0	0	0	0
	Red(61)	0	0	0	0	1	0	0	0	0	0	0	0	0	0	0	0	0	0
	:	:	:	:	:	:	:	:	:	:	:	:	:	:	:	:	:	:	:
	Red(31)	0	1	1	1	1	1	0	0	0	0	0	0	0	0	0	0	0	0
	:	:	:	:	:	:	:	:	:	:	:	:	:	:	:	:	:	:	:
Green	Red(1)	1	1	1	1	1	0	0	0	0	0	0	0	0	0	0	0	0	0
	Red(0)	1	1	1	1	1	1	0	0	0	0	0	0	0	0	0	0	0	0
	Black	0	0	0	0	0	0	0	0	0	0	0	0	0	0	0	0	0	0
	Green(62)	0	0	0	0	0	0	0	0	0	0	0	1	0	0	0	0	0	0
	Green(61)	0	0	0	0	0	0	0	0	0	0	1	0	0	0	0	0	0	0
	:	:	:	:	:	:	:	:	:	:	:	:	:	:	:	:	:	:	:
Blue	Green(31)	0	0	0	0	0	0	0	1	1	1	1	0	0	0	0	0	0	0
	:	:	:	:	:	:	:	:	:	:	:	:	:	:	:	:	:	:	:
	Green(1)	0	0	0	0	0	0	1	1	1	1	1	0	0	0	0	0	0	0
	Green(0)	0	0	0	0	0	0	1	1	1	1	1	1	0	0	0	0	0	0
	Black	0	0	0	0	0	0	0	0	0	0	0	0	0	0	0	0	0	0
	Blue(62)	0	0	0	0	0	0	0	0	0	0	0	0	0	0	0	0	0	1
Blue	Blue(61)	0	0	0	0	0	0	0	0	0	0	0	0	0	0	0	0	1	0
	:	:	:	:	:	:	:	:	:	:	:	:	:	:	:	:	:	:	:
	Blue(31)	0	0	0	0	0	0	0	0	0	0	0	0	0	1	1	1	1	1
	:	:	:	:	:	:	:	:	:	:	:	:	:	:	:	:	:	:	:
Blue(1)	0	0	0	0	0	0	0	0	0	0	0	0	1	1	1	1	1	0	
Blue(0)	0	0	0	0	0	0	0	0	0	0	0	0	1	1	1	1	1	1	

0 : Low level voltage, 1 :High level voltage

Each basic color can be displayed in 64 gray scales from 6 bit data signals. With the combination of total 18 bit data signals, the 262,144-color display can be achieved on the screen.

Product Specification				
	RS800480T-7X0GP-A	Rev. No.	Issued Date.	Page.
		F	2010, OCT. 13	18 / 20

7. Touch Screen Panel Specifications

7.1 Touch Panel

7.1.1 Electrical Characteristics

Item	Min.	Typ.	Max.	Unit	Note
Linearity	-1.5	-	1.5	%	Analog X and Y directions
Terminal resistance	200	-	400	Ω	Y(Glass side)
	200	-	900	Ω	X(Film side)
Insulation resistance	20	-	-	M Ω	DC 25V
Voltage	-	5.0	7.0	V	DC
Response time	-	15	-	ms	
Transparency	-	80	-	%	Non-glare

Caution (1) : Do not operate it with a thing except a polyacetal pen (tip R0.8mm or less) or a finger, especially those with hard or sharp tips such as a ball point pen or a mechanical pencil.

7.1.2 Mechanical & Reliability Characteristics

Item	Min.	Typ.	Max.	Unit	Note
Activation force	-		80	g	(1)
Hitting Durability	1,000,000	-	-	times	(2)
Sliding Durability	100,000			times	
Surface hardness	3	-	-	H	JIS K5400

Note (1) Input : Finger or polyacetal pen 0.8R

Note (2) Pit 1,000,000 times on the Film with a R8.0 (Hardness 60°) silicon rubber.

- Force : Force : 200g
- Frequency : 3 times/sec

Product Specification

	RS800480T-7X0GP-A	Rev. No.	Issued Date.	Page.
		F	2010, OCT. 13	19 / 20

8. Reliability Condition

No change on display and in operation under the following test condition.

Condition: Unless otherwise specified, tests will be conducted under the following condition.

Temperature: $20 \pm 5^\circ\text{C}$.

Humidity: $65 \pm 5\% \text{RH}$.

Tests will be not conducted under functioning state.

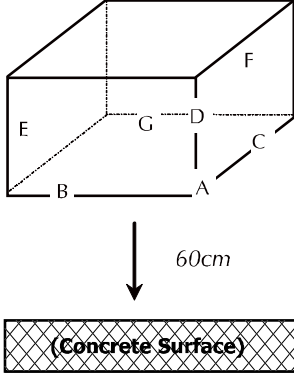
No.	Parameter	Condition	Notes
1	High Temperature Operating	$60^\circ\text{C} \pm 2^\circ\text{C}$, 240hrs (Operation state).	
2	Low Temperature Operating	$-10^\circ\text{C} \pm 2^\circ\text{C}$, 240hrs (Operation state).	1
3	High Temperature Storage	$70^\circ\text{C} \pm 2^\circ\text{C}$, 240hrs.	2
4	Low Temperature Storage	$-20^\circ\text{C} \pm 2^\circ\text{C}$, 240hrs.	1,2
5	High Temperature and High Humidity Operation Test	$50^\circ\text{C} \pm 2^\circ\text{C}$, 90%, 240hrs.	1,2
6	Vibration Test	Total fixed amplitude: 1.5mm. Vibration Frequency: 10~55Hz. One cycle 60 seconds to 3 direction of X, Y, Z each 15 minutes.	3
7.	Drop Test	<p>To be measured after dropping from 60cm high on the concrete surface in packing state.</p> <div style="text-align: center;">  </div> <p style="text-align: right; color: blue;"><i>Dropping method corner dropping:</i></p> <p style="text-align: right; color: blue;"><i>A corner: Once edge dropping.</i></p> <p style="text-align: right; color: blue;"><i>B, C, D edge: Once face dropping.</i></p> <p style="text-align: right; color: blue;"><i>E, F, G face: Once.</i></p>	

- Notes:
1. No dew condensation to be observed.
 2. The function test shall be conducted after 4 hours storage at the normal temperature and humidity after removed from the test chamber.
 3. Vibration test will be conducted to the product itself without putting I in a container.

Product Specification



RS800480T-7X0GP-A

Rev. No.

Issued Date.

Page.

F

2010, OCT. 13

20 / 20

9. Dimensional Outlines

