



RSD221N06

Nch 60V 22A Power MOSFET

Datasheet

V_{DSS}	60V
$R_{DS(on)}$ (Max.)	26m Ω
I_D	22A
P_D	20W

●Features

- 1) Low on-resistance.
- 2) Fast switching speed.
- 3) Drive circuits can be simple.
- 4) Parallel use is easy.
- 5) Pb-free lead plating ; RoHS compliant
- 6) 100% Avalanche tested

●Application

Switching Power Supply
Automotive Motor Drive
Automotive Solenoid Drive

●Absolute maximum ratings($T_a = 25^\circ\text{C}$)

Parameter	Symbol	Value	Unit	
Drain - Source voltage	V_{DSS}	60	V	
Continuous drain current	$T_c = 25^\circ\text{C}$	I_D^{*1}	± 22	A
	$T_c = 100^\circ\text{C}$	I_D^{*1}	± 11	A
Pulsed drain current	$I_{D,pulse}^{*2}$	± 44	A	
Gate - Source voltage	V_{GSS}	± 20	V	
Avalanche energy, single pulse	E_{AS}^{*3}	17.8	mJ	
Avalanche current	I_{AR}^{*3}	22	A	
Power dissipation	$T_c = 25^\circ\text{C}$	P_D	20	W
	$T_a = 25^\circ\text{C}^{*4}$	P_D	0.85	W
Junction temperature	T_j	150	$^\circ\text{C}$	
Range of storage temperature	T_{stg}	-55 to +150	$^\circ\text{C}$	

●Outline

CPT3
(SC-63)
<SOT-428>

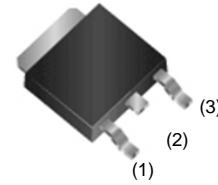

●Inner circuit

- (1) Gate
(2) Drain
(3) Source

*1 ESD PROTECTION DIODE
*2 BODY DIODE

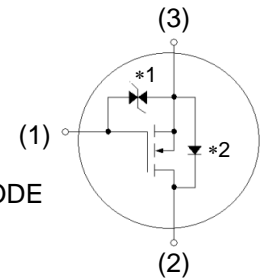

●Packaging specifications

Type	Packaging	Taping
	Reel size (mm)	330
	Tape width (mm)	16
	Basic ordering unit (pcs)	2,500
	Taping code	TL
	Marking	221N06

●Thermal resistance

Parameter	Symbol	Values			Unit
		Min.	Typ.	Max.	
Thermal resistance, junction - ambient	R_{thJC}	-	-	6.25	°C/W
Thermal resistance, junction - ambient *4	R_{thJA}	-	-	147	°C/W
Soldering temperature, wavesoldering for 10s	T_{sold}	-	-	265	°C

●Electrical characteristics($T_a = 25^\circ\text{C}$)

Parameter	Symbol	Conditions	Values			Unit
			Min.	Typ.	Max.	
Drain - Source breakdown voltage	$V_{(BR)DSS}$	$V_{GS} = 0V, I_D = 1mA$	60	-	-	V
Zero gate voltage drain current	I_{DSS}	$V_{DS} = 60V, V_{GS} = 0V$ $T_j = 25^\circ\text{C}$	-	-	1	μA
		$V_{DS} = 60V, V_{GS} = 0V$ $T_j = 125^\circ\text{C}$	-	-	100	
Gate - Source leakage current	I_{GSS}	$V_{GS} = \pm 20V, V_{DS} = 0V$	-	-	± 10	μA
Gate threshold voltage	$V_{GS(th)}$	$V_{DS} = 10V, I_D = 1mA$	1.0	-	3.0	V
Static drain - source on - state resistance	$R_{DS(on)}$ *5	$V_{GS} = 10V, I_D = 22A$	-	18	26	$m\Omega$
		$V_{GS} = 4.5V, I_D = 22A$	-	21	30	
		$V_{GS} = 4.0V, I_D = 22A$	-	23	33	
		$V_{GS} = 10V, I_D = 22A$ $T_j = 125^\circ\text{C}$	-	32	45	
Forward transfer admittance	g_{fs}	$V_{DS} = 10V, I_D = 22A$	12	24	-	S

●Electrical characteristics($T_a = 25^\circ\text{C}$)

Parameter	Symbol	Conditions	Values			Unit
			Min.	Typ.	Max.	
Input capacitance	C_{iss}	$V_{GS} = 0V$	-	1500	-	pF
Output capacitance	C_{oss}	$V_{DS} = 10V$	-	320	-	
Reverse transfer capacitance	C_{rss}	$f = 1\text{MHz}$	-	140	-	
Turn - on delay time	$t_{d(on)}^{*5}$	$V_{DD} \approx 30V, V_{GS} = 10V$	-	25	-	ns
Rise time	t_r^{*5}	$I_D = 11A$	-	45	-	
Turn - off delay time	$t_{d(off)}^{*5}$	$R_L = 12\Omega$	-	75	-	
Fall time	t_f^{*5}	$R_G = 10\Omega$	-	65	-	

●Gate Charge characteristics($T_a = 25^\circ\text{C}$)

Parameter	Symbol	Conditions	Values			Unit
			Min.	Typ.	Max.	
Total gate charge	Q_g^{*5}	$V_{DD} \approx 30V$	-	30	-	nC
Gate - Source charge	Q_{gs}^{*5}	$I_D = 22A$	-	4.5	-	
Gate - Drain charge	Q_{gd}^{*5}	$V_{GS} = 10V$	-	3.0	-	
Gate plateau voltage	$V_{(plateau)}$	$V_{DD} \approx 30V, I_D = 22A$	-	3.3	-	V

●Body diode electrical characteristics (Source-Drain)($T_a = 25^\circ\text{C}$)

Parameter	Symbol	Conditions	Values			Unit
			Min.	Typ.	Max.	
Continuous source current	I_S^{*1}	$T_c = 25^\circ\text{C}$	-	-	16	A
Pulsed source current	I_{SM}^{*2}		-	-	44	A
Forward voltage	V_{SD}^{*5}	$V_{GS} = 0V, I_S = 22A$	-	-	1.2	V
Reverse recovery time	t_{rr}^{*5}	$I_S = 22A$	-	56	-	ns
Reverse recovery charge	Q_{rr}^{*5}	$di/dt = 100A/\mu\text{s}$	-	100	-	μC

*1 Limited only by maximum temperature allowed.

*2 $P_w \leq 10\mu\text{s}$, Duty cycle $\leq 1\%$

*3 $L \approx 50\mu\text{H}$, $V_{DD} = 30V$, $R_g = 10\Omega$, starting $T_j = 25^\circ\text{C}$

*4 Mounted on a epoxy PCB FR4 (20mm x 30mm x 0.8mm)

*5 Pulsed

●Electrical characteristic curves

Fig.1 Power Dissipation Derating Curve

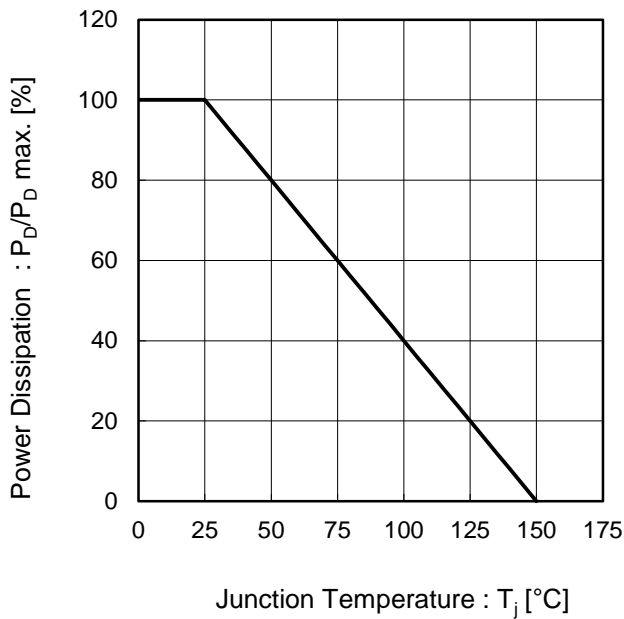

Fig.2 Maximum Safe Operating Area

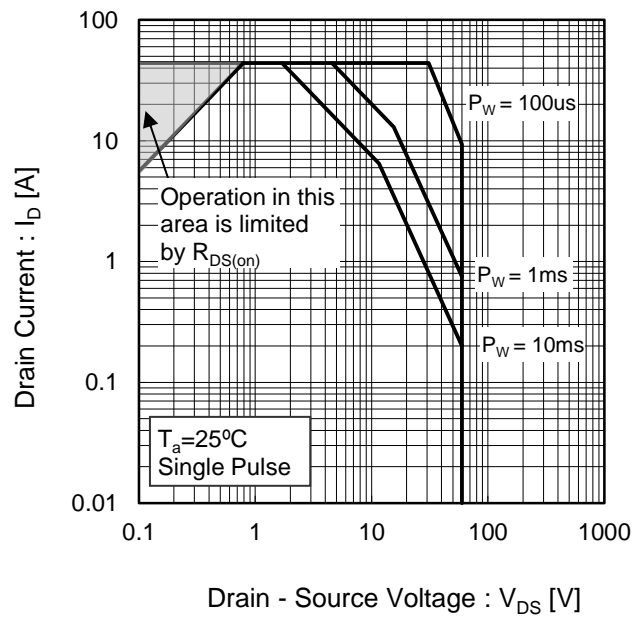
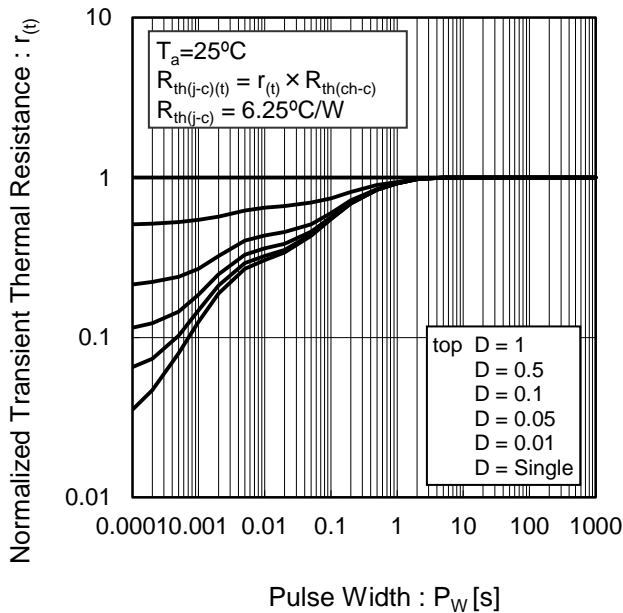

Fig.3 Normalized Transient Thermal Resistance vs. Pulse Width



●Electrical characteristic curves

Fig.4 Avalanche Current vs Inductive Load

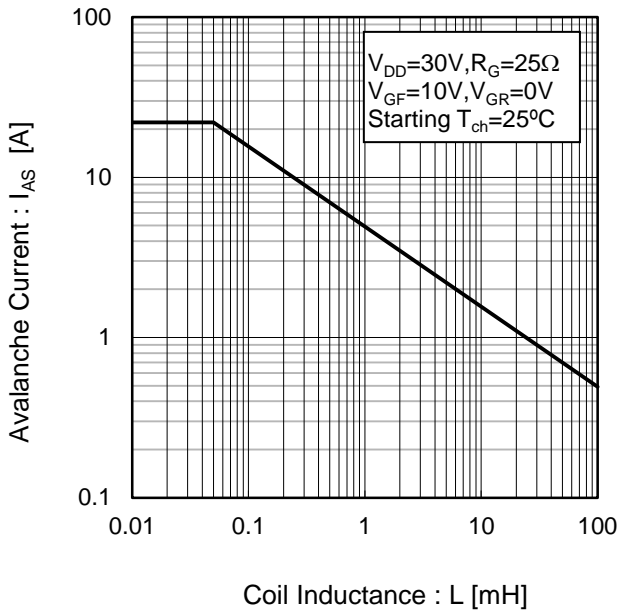

Fig.5 Avalanche Energy Derating Curve vs Junction Temperature

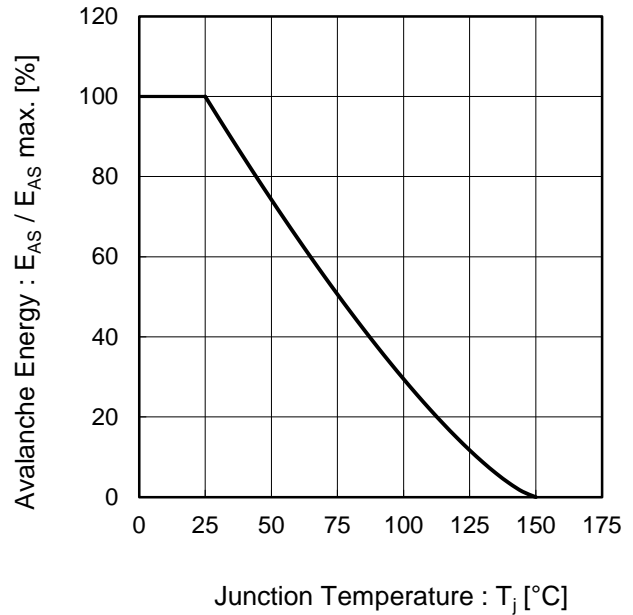

Fig.6 Typical Output Characteristics(I)

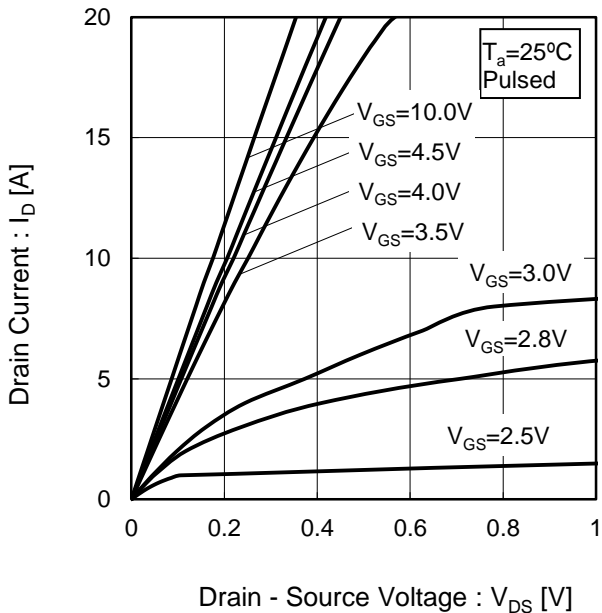
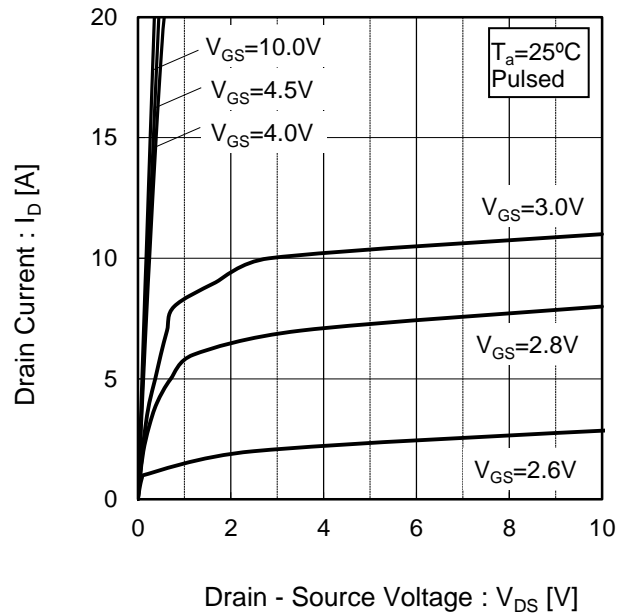

Fig.7 Typical Output Characteristics(II)



●Electrical characteristic curves

Fig.8 Breakdown Voltage vs. Junction Temperature

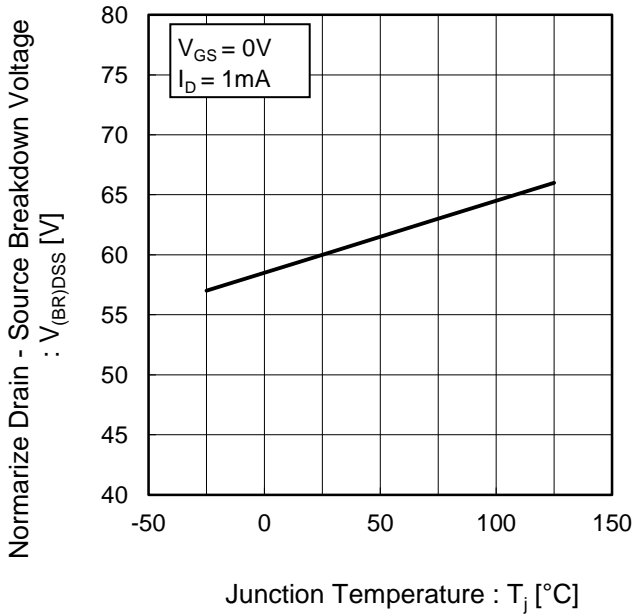

Fig.9 Typical Transfer Characteristics

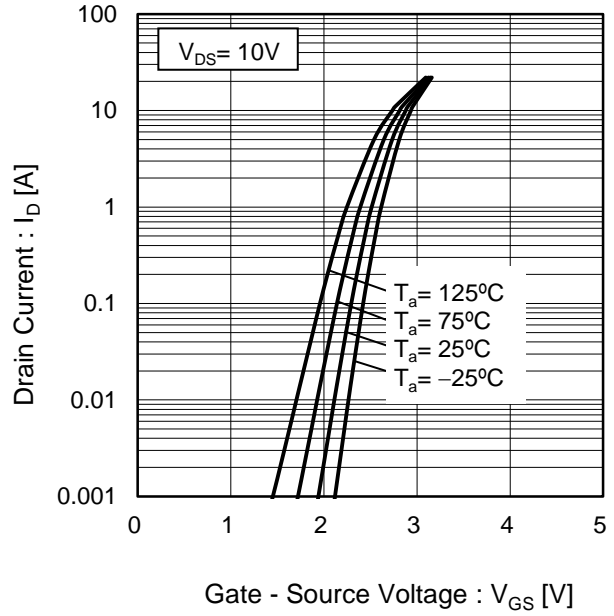

Fig.10 Gate Threshold Voltage vs. Junction Temperature

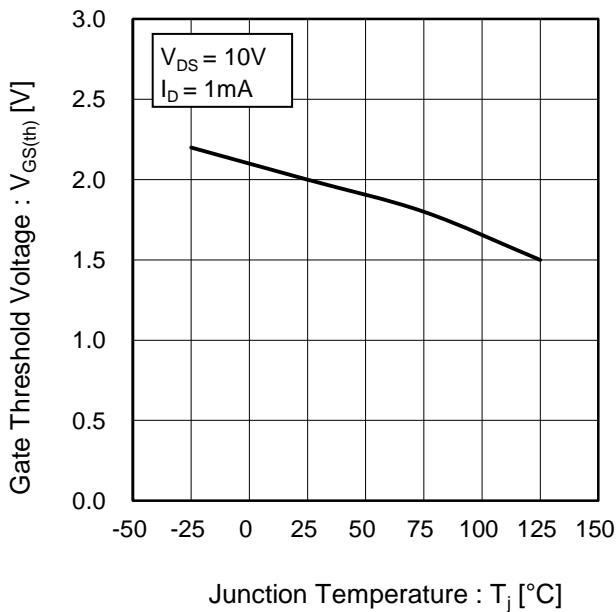
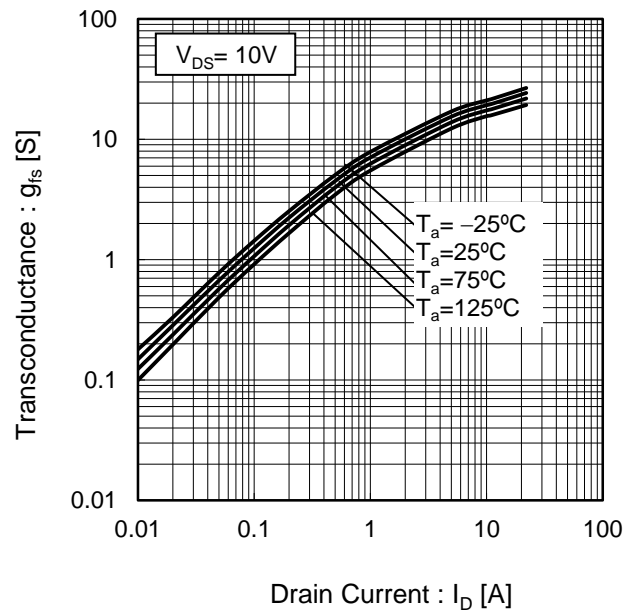

Fig.11 Transconductance vs. Drain Current



●Electrical characteristic curves

Fig.12 Static Drain - Source On - State Resistance vs. Gate Source Voltage

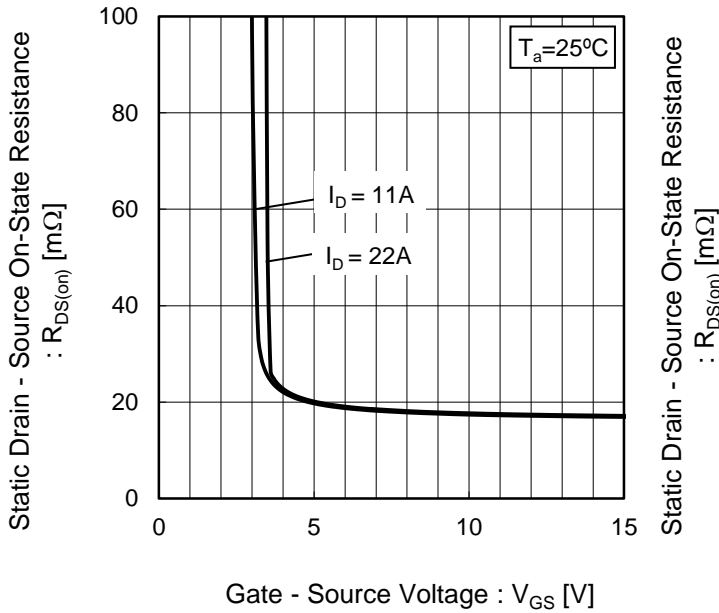

Fig.13 Static Drain - Source On - State Resistance vs. Drain Current(I)

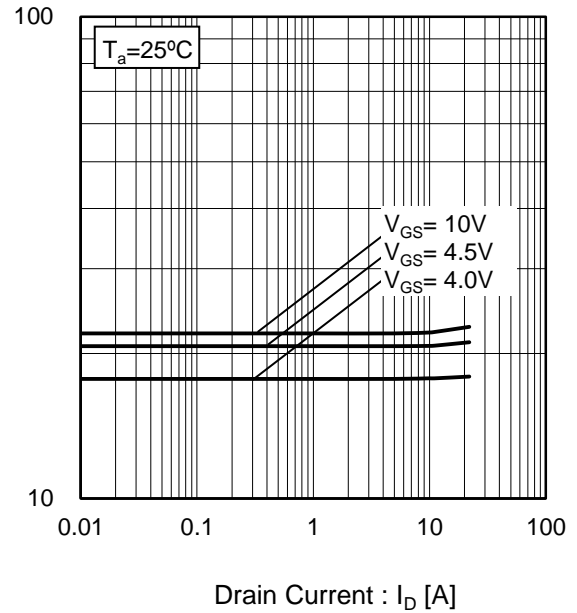
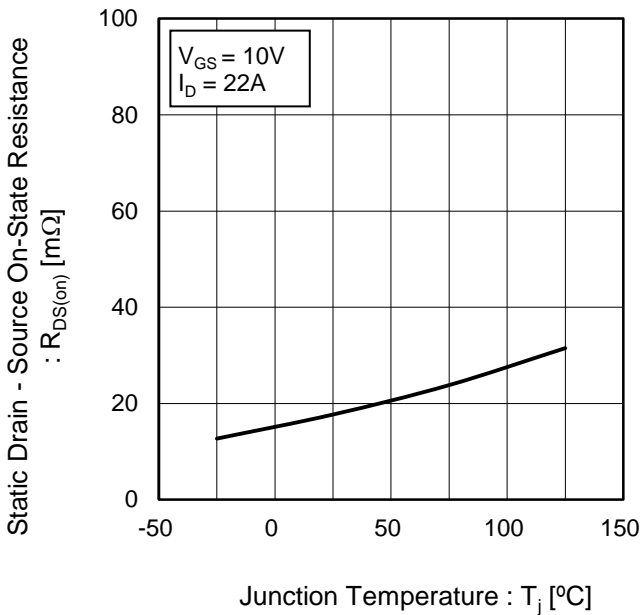

Fig.14 Static Drain - Source On - State Resistance vs. Junction Temperature



●Electrical characteristic curves

Fig.15 Static Drain - Source On - State Resistance vs. Drain Current(II)

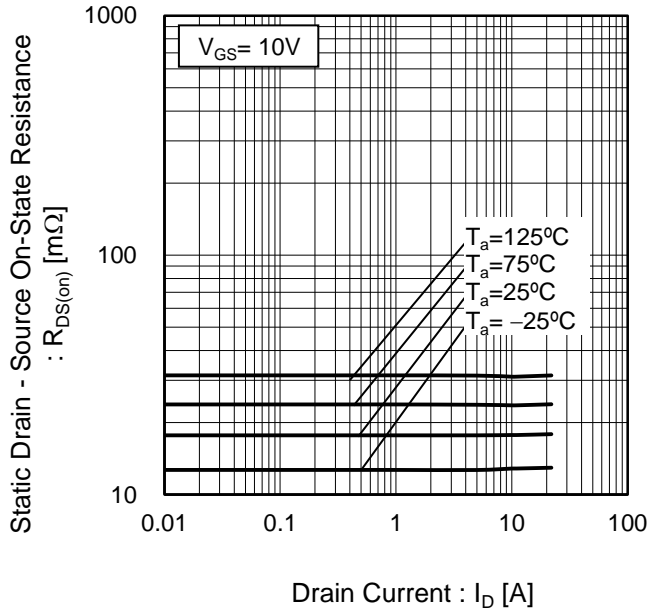

Fig.16 Static Drain - Source On - State Resistance vs. Drain Current(III)

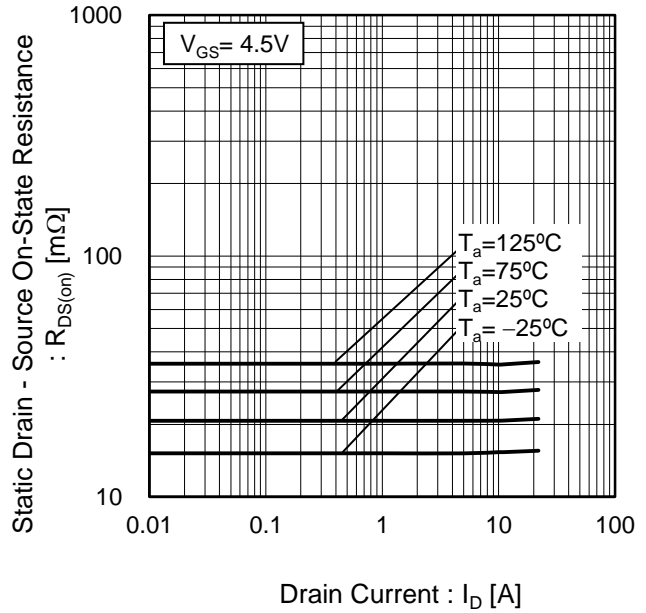

Fig.17 Static Drain - Source On - State Resistance vs. Drain Current(IV)

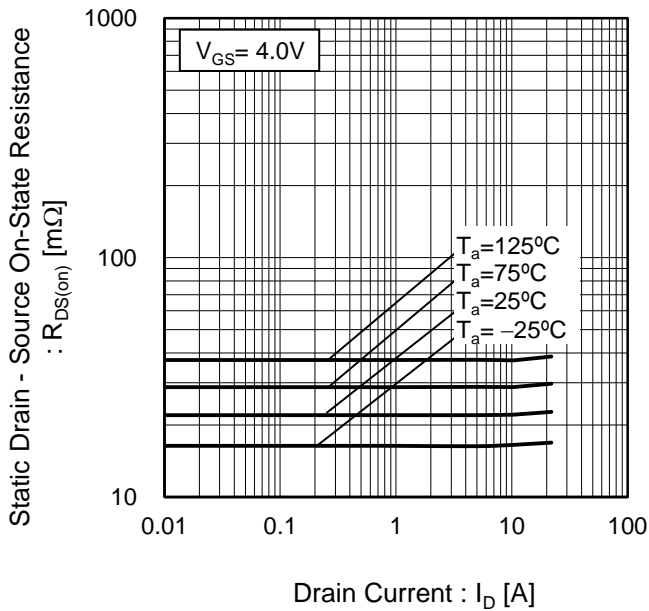
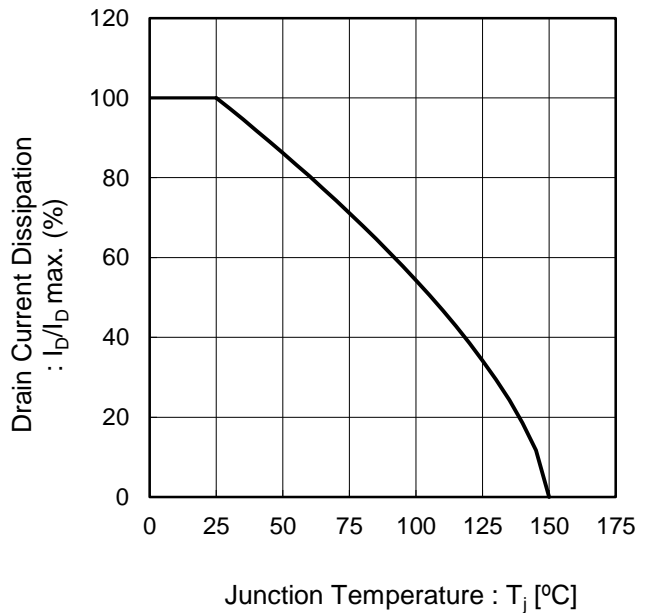

Fig.18 Drain Current Derating Curve



●Electrical characteristic curves

Fig.19 Typical Capacitance vs. Drain - Source Voltage

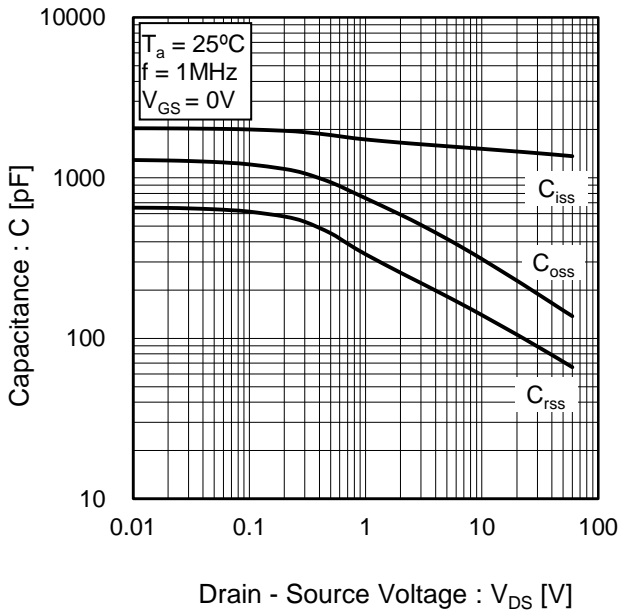

Fig.20 Switching Characteristics

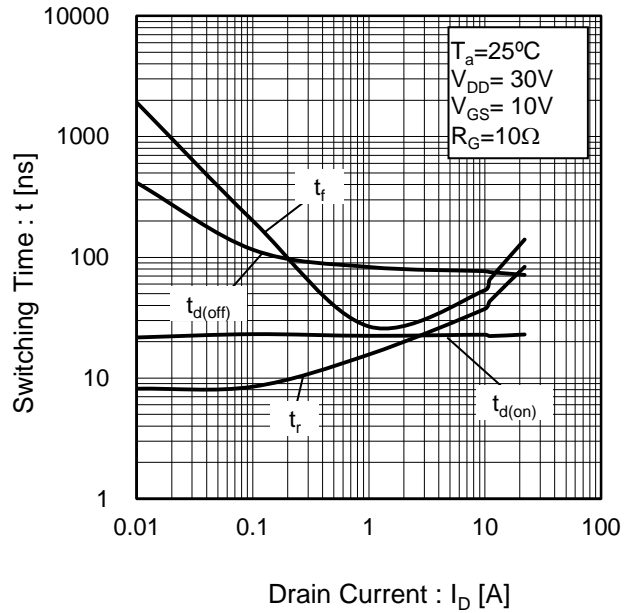

Fig.21 Dynamic Input Characteristics

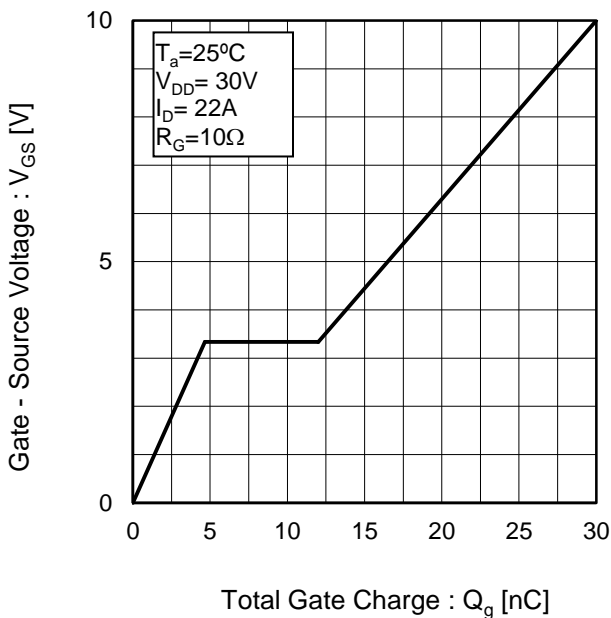
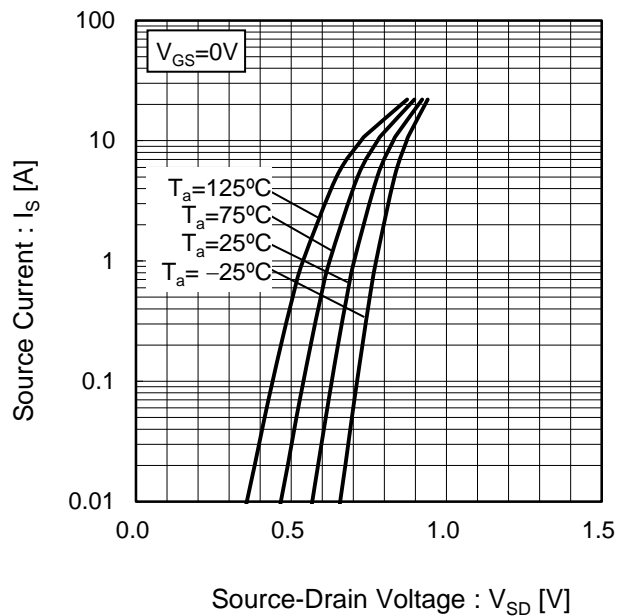
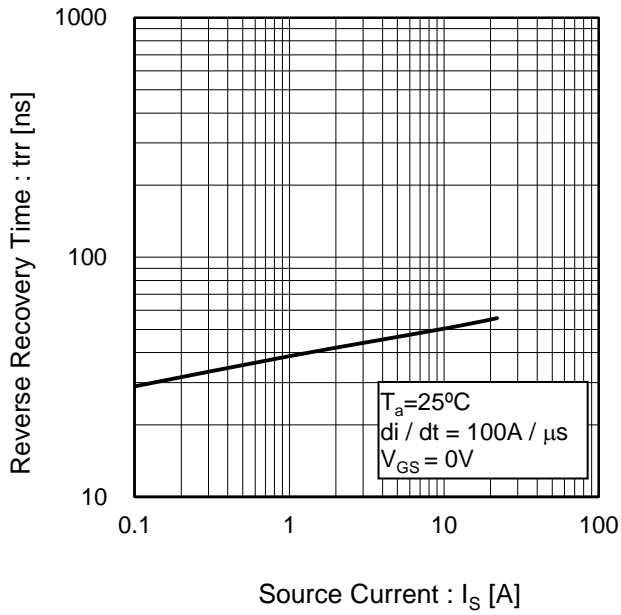

Fig.22 Source Current vs. Source - Drain Voltage



●Electrical characteristic curves

Fig23 Reverse Recovery Time vs.Source Current



● Measurement circuits

Fig.1-1 Switching Time Measurement Circuit



Fig.1-2 Switching Waveforms



Fig.2-1 Gate Charge Measurement Circuit

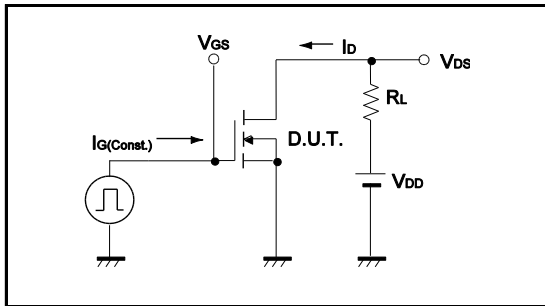

Fig.2-2 Gate Charge Waveform

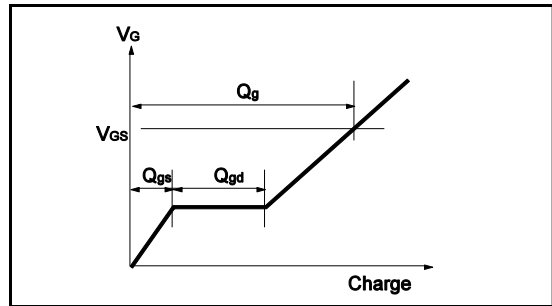
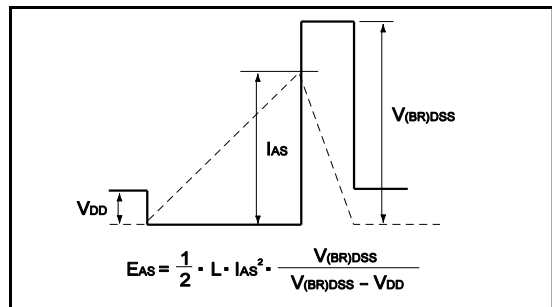

Fig.3-1 Avalanche Measurement Circuit

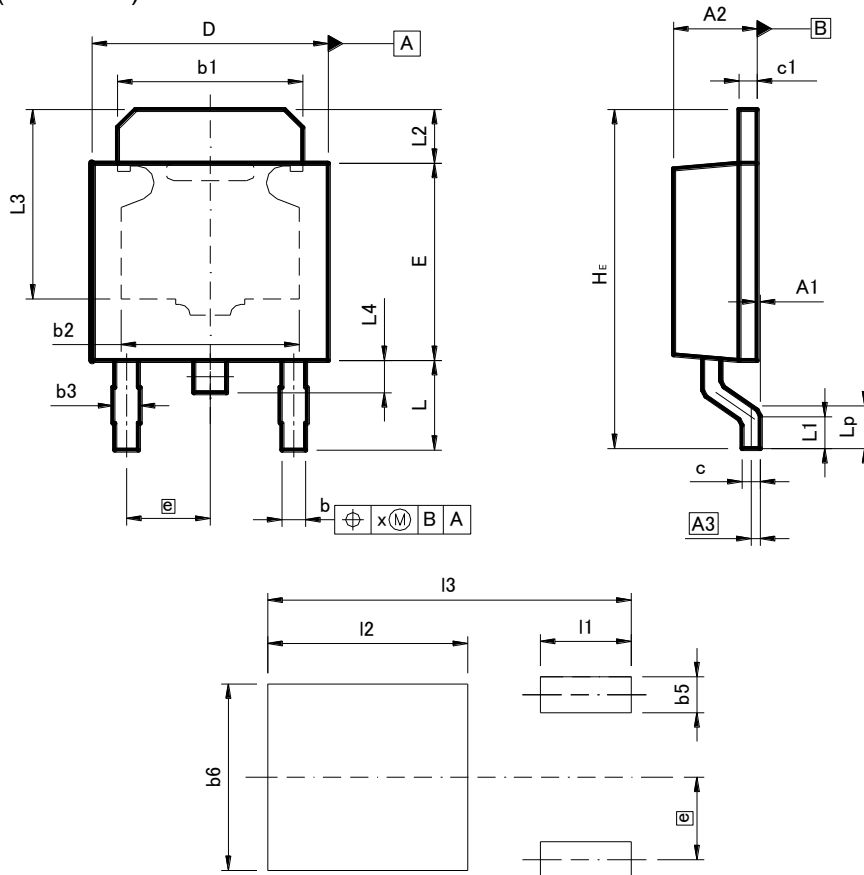

Fig.3-2 Avalanche Waveform



●Dimensions (Unit : mm)

CPT3



DIM	MILIMETERS		INCHES	
	MIN	MAX	MIN	MAX
A1	0.00	0.15	0	0.006
A2	2.20	2.50	0.087	0.098
A3	0.25		0.01	
b	0.55	0.75	0.022	0.03
b1	5.00	5.30	0.197	0.209
b2	5.00		0.20	
b3	0.75		0.03	
c	0.40	0.60	0.016	0.024
c1	0.40	0.60	0.016	0.024
D	6.30	6.70	0.248	0.264
E	5.40	5.80	0.213	0.228
e	2.30		0.09	
HE	9.00	10.00	0.354	0.394
L	2.20	2.80	0.087	0.11
L1	0.80	1.40	0.031	0.055
L2	1.20	1.80	0.047	0.071
L3	5.30		0.209	
L4	0.90		0.035	
Lp	1.00	1.60	0.039	0.063
x	-	0.25	-	0.01

DIM	MILIMETERS		INCHES	
	MIN	MAX	MIN	MAX
b5	-	1.00	-	0.04
b6	-	5.20	-	0.205
I1	-	2.50	-	0.098
I2	-	5.50	-	0.217
I3	-	10.00	-	0.394

Dimension in mm/inches

Notes

No copying or reproduction of this document, in part or in whole, is permitted without the consent of ROHM Co.,Ltd.

The content specified herein is subject to change for improvement without notice.

The content specified herein is for the purpose of introducing ROHM's products (hereinafter "Products"). If you wish to use any such Product, please be sure to refer to the specifications, which can be obtained from ROHM upon request.

Examples of application circuits, circuit constants and any other information contained herein illustrate the standard usage and operations of the Products. The peripheral conditions must be taken into account when designing circuits for mass production.

Great care was taken in ensuring the accuracy of the information specified in this document. However, should you incur any damage arising from any inaccuracy or misprint of such information, ROHM shall bear no responsibility for such damage.

The technical information specified herein is intended only to show the typical functions of and examples of application circuits for the Products. ROHM does not grant you, explicitly or implicitly, any license to use or exercise intellectual property or other rights held by ROHM and other parties. ROHM shall bear no responsibility whatsoever for any dispute arising from the use of such technical information.

The Products specified in this document are intended to be used with general-use electronic equipment or devices (such as audio visual equipment, office-automation equipment, communication devices, electronic appliances and amusement devices).

The Products specified in this document are not designed to be radiation tolerant.

While ROHM always makes efforts to enhance the quality and reliability of its Products, a Product may fail or malfunction for a variety of reasons.

Please be sure to implement in your equipment using the Products safety measures to guard against the possibility of physical injury, fire or any other damage caused in the event of the failure of any Product, such as derating, redundancy, fire control and fail-safe designs. ROHM shall bear no responsibility whatsoever for your use of any Product outside of the prescribed scope or not in accordance with the instruction manual.

The Products are not designed or manufactured to be used with any equipment, device or system which requires an extremely high level of reliability the failure or malfunction of which may result in a direct threat to human life or create a risk of human injury (such as a medical instrument, transportation equipment, aerospace machinery, nuclear-reactor controller, fuel-controller or other safety device). ROHM shall bear no responsibility in any way for use of any of the Products for the above special purposes. If a Product is intended to be used for any such special purpose, please contact a ROHM sales representative before purchasing.

If you intend to export or ship overseas any Product or technology specified herein that may be controlled under the Foreign Exchange and the Foreign Trade Law, you will be required to obtain a license or permit under the Law.



Thank you for your accessing to ROHM product informations.
More detail product informations and catalogs are available, please contact us.

ROHM Customer Support System

<http://www.rohm.com/contact/>

