

ROTEL hi-fi

ROTEL hi-fi

ROTEL hi-fi

ROTEL hi-fi

ROTEL hi-fi

ROTEL hi-fi

ROTEL hi-fi

ROTEL hi-fi

ROTEL hi-fi

ROTEL hi-fi

ROTEL hi-fi

ROTEL hi-fi

ROTEL hi-fi

ROTEL hi-fi

ROTEL hi-fi

ROTEL hi-fi

ROTEL hi-fi

ROTEL hi-fi

ROTEL hi-fi

ROTEL hi-fi

RSP-975

DIGITAL SURROUND SOUND PROCESSOR

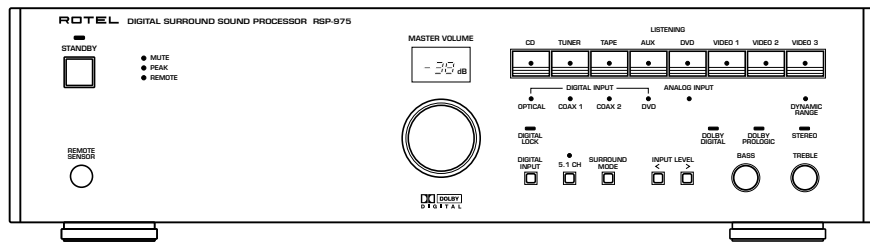

Owner's Manual

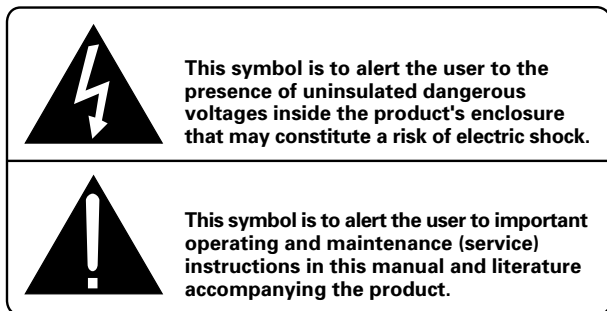
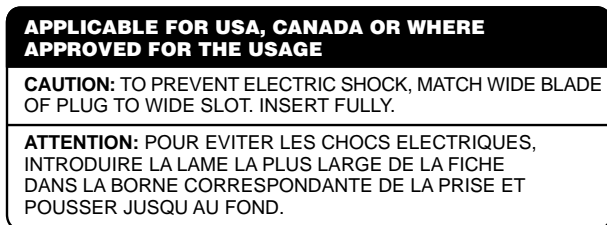

WARNING:
There are no user serviceable parts inside. Refer all servicing to qualified service personnel.

WARNING:
To reduce the risk of fire or electric shock, do not expose the unit to moisture or water. Do not allow foreign objects to get into the enclosure. If the unit is exposed to moisture, or a foreign object gets into the enclosure, immediately disconnect the power cord from the wall. Take the unit to a qualified service person for inspection and necessary repairs.

Read all the instructions before connecting or operating the component. Keep this manual so you can refer to these safety instructions.

Heed all warnings and safety information in these instructions and on the product itself. Follow all operating instructions.

Clean the enclosure only with a dry cloth or a vacuum cleaner .

Keep the ventilation inlets on the unit unobstructed. For example, do not place the unit on a bed, sofa, rug, or similar surface that could block the ventilation slots. If the unit is placed in a bookcase or cabinet, there must be sufficient clearance around the unit and ventilation of the cabinet to allow proper cooling.

Keep the component away from radiators, heat registers, stoves, or any other appliance that produces heat.

The unit must be connected to a power supply only of the type and voltage specified on the rear panel of the unit.

Connect the component to the power outlet only with the supplied power supply cable or an exact equivalent. Do not modify the supplied cable in any way . Do not attempt to defeat grounding and/or polarization provisions. The cable should be connected to a 2-pin polarized wall outlet, matching the wide blade of the plug to the wide slot of the receptacle. Do not use extension cords.

Do not route the power cord where it will be crushed, pinched, bent at severe angles, exposed to heat, or damaged in any way . Pay particular attention to the power cord at the plug and where it exits the back of the unit.

The power cord should be unplugged from the wall outlet if the unit is to be left unused for a long period of time.

Immediately stop using the component and have it inspected and/or serviced by a qualified service agency if:

- The power supply cord or plug has been damaged.
- Objects have fallen or liquid has been spilled into the unit.
- The unit has been exposed to rain.
- The unit shows signs of improper operation
- The unit has been dropped or damaged in any way

Place the unit on a fixed, level surface strong enough to support its weight. Do not place it on a moveable cart that could tip over .



Figure 1: Controls and Connections

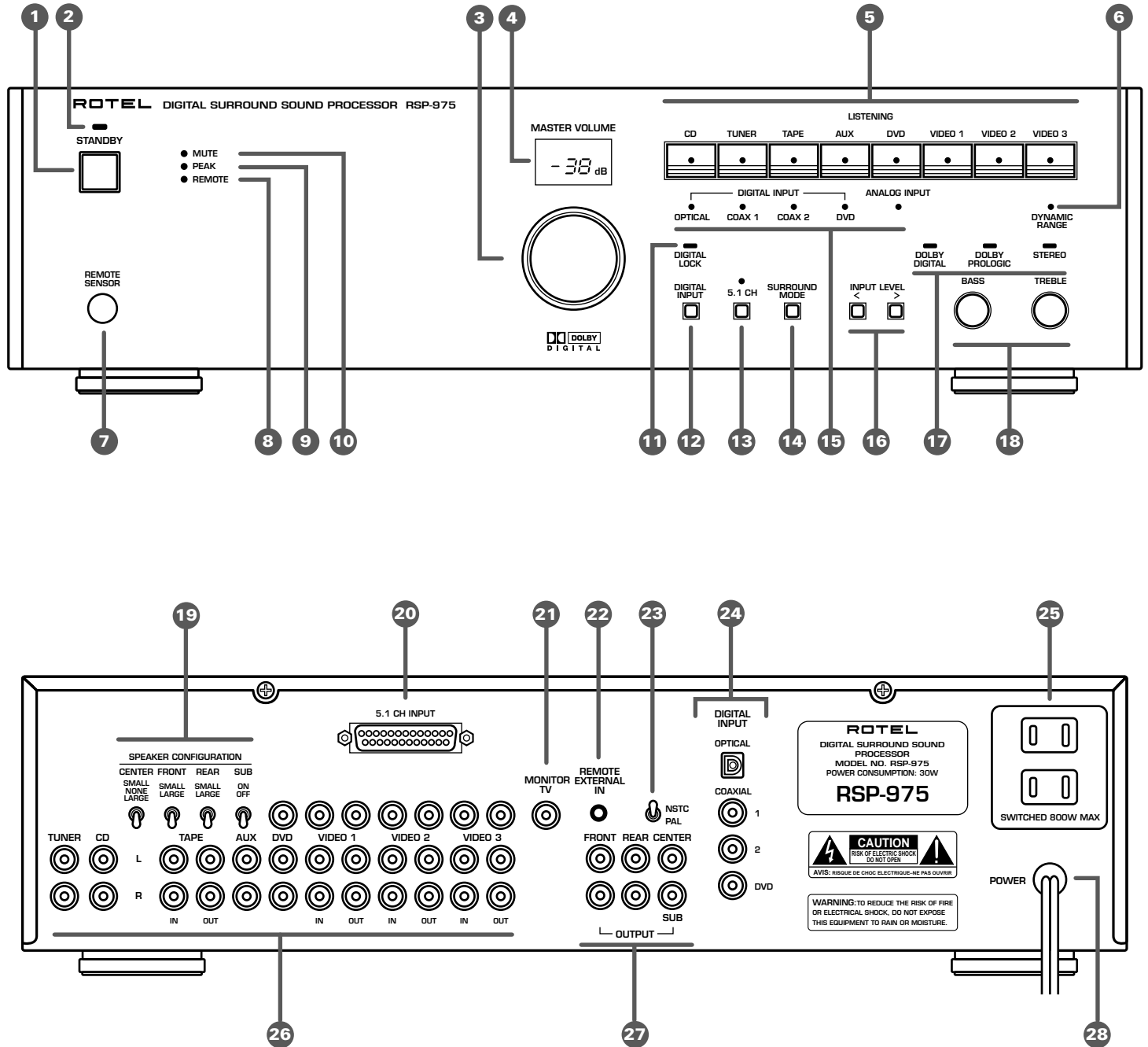

Figure 2: Remote Control

Figure 3: Output Connections

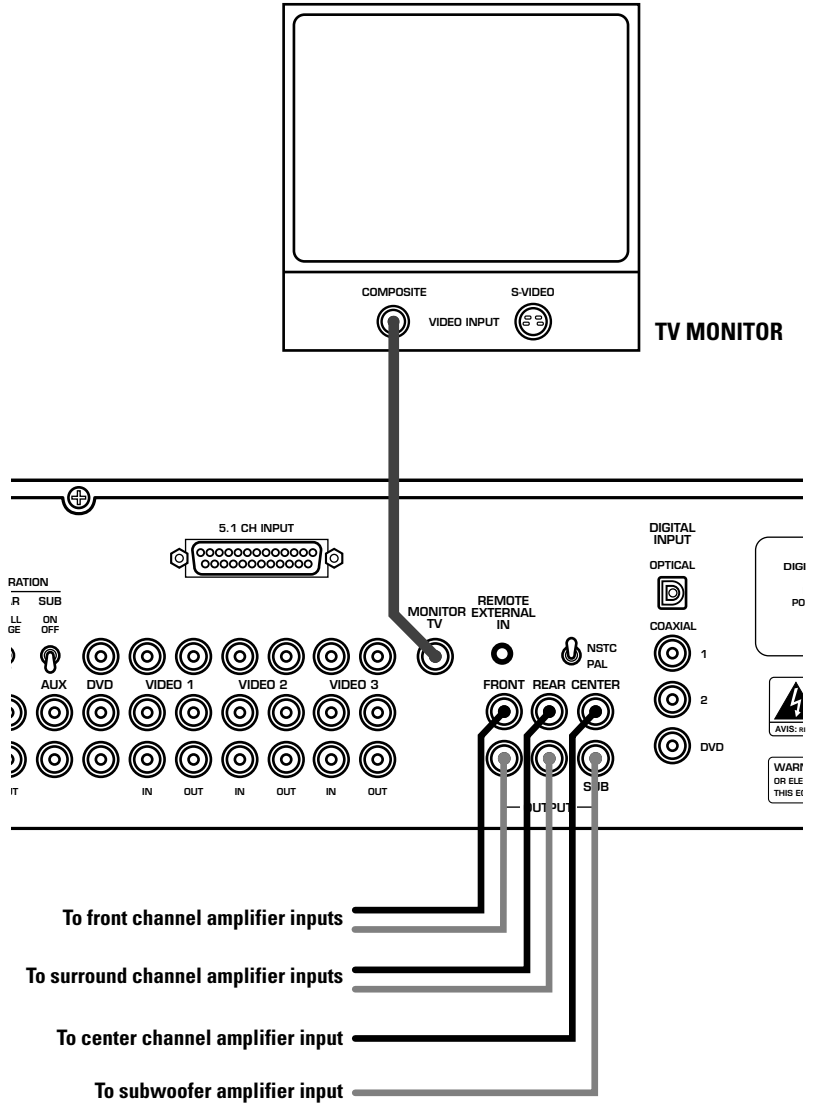
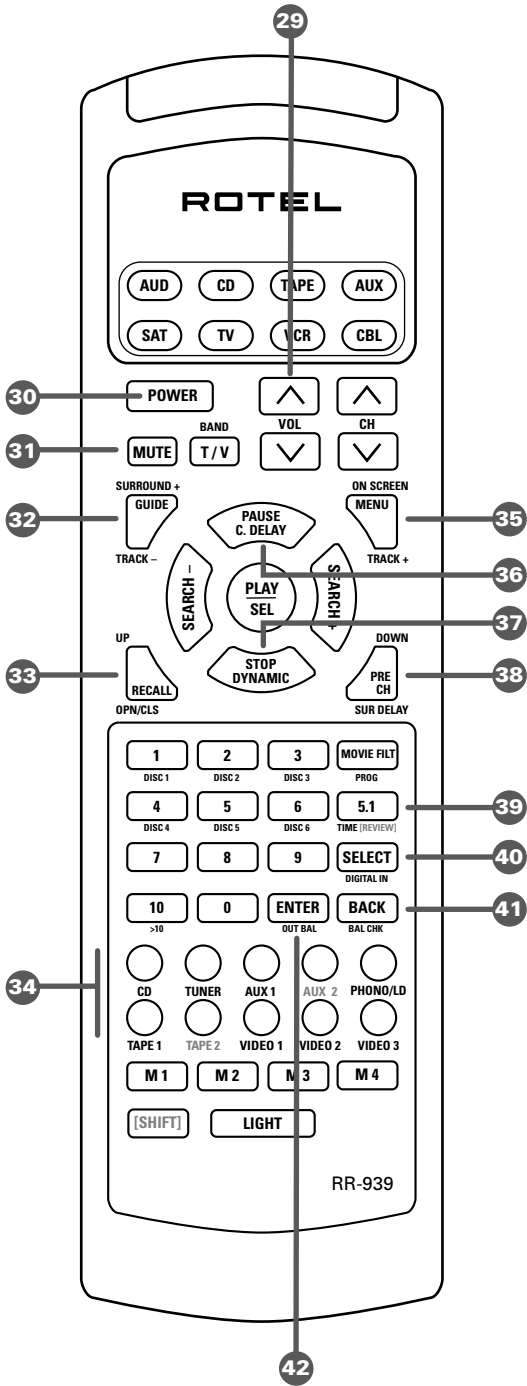
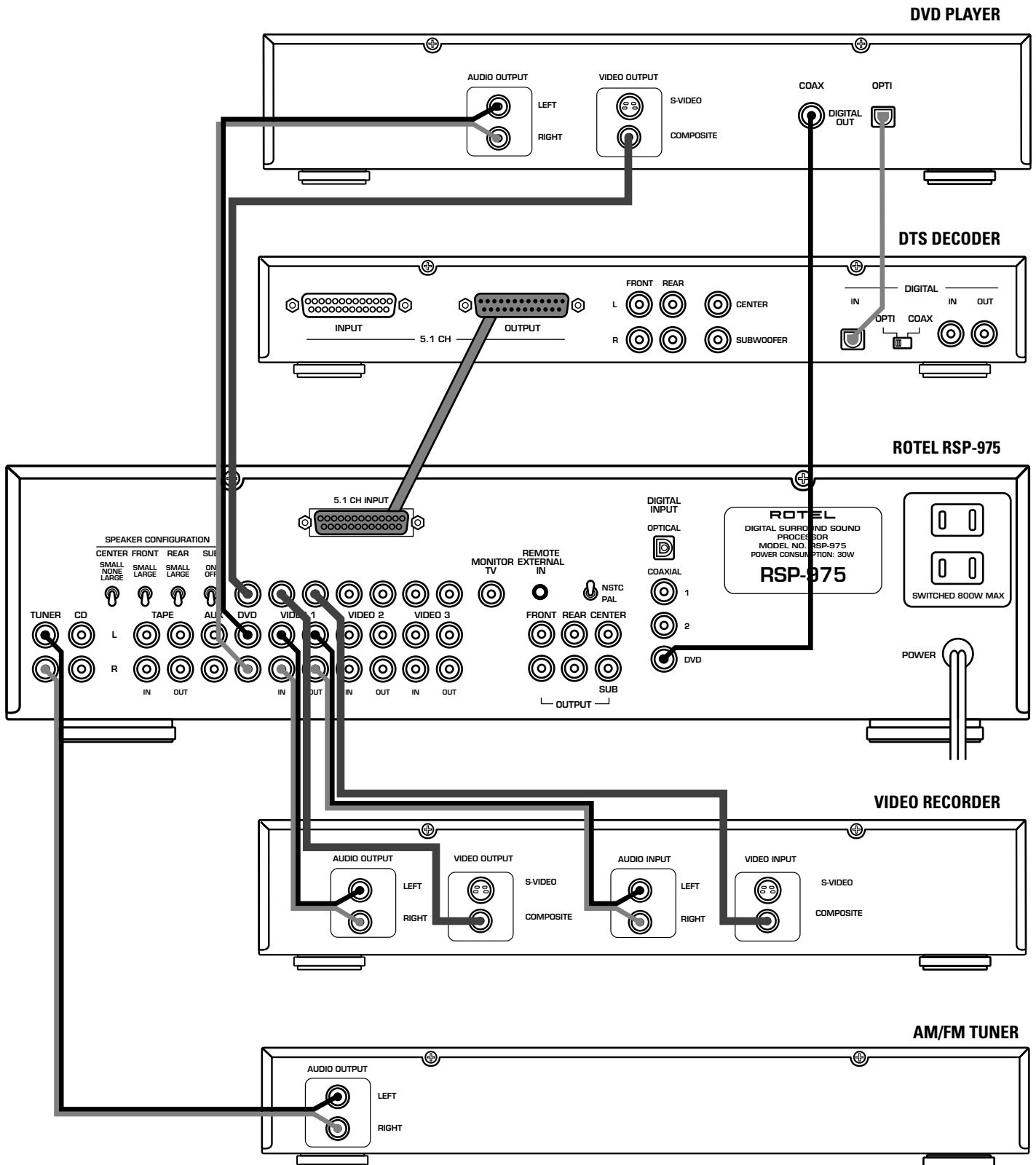

Figure 4: Input Connections



Contents

Figure 1: Controls and Connections	3	The On-Screen Display _____	12
Figure 2: Remote Control	4	MAIN Screen	12
Figure 3: Output Connections	4	OUTPUT BALANCE Screen	12
Figure 4: Input Connections	5	Rear Panel Input Connections _____	13
About Rotel	7	Source Inputs 26	13
Getting Started _____	7	Digital Inputs 24	13
RSP-975 Key Features	7	5.1 CH INPUT 20	13
Unpacking the RSP-975	7	REMOTE EXTERNAL IN Jack 22	13
Placement	7	Rear Panel Output Connections _____	13
Front Panel Controls _____	7	Source Outputs 26	14
STANDBY Switch 1 30 and STANDBY LED 2	7	Main Audio Outputs 27	14
Remote Sensor 7	8	MONITOR TV Output 21	14
MASTER VOLUME Control 3 29	8	Rear Panel Configuration Switches _____	14
VOLUME Display 4	8	NTSC/PAL Video Switch 23	14
TONE Controls 18	8	SPEAKER CONFIGURATION Switches 19	14
LISTENING SOURCE Buttons 5 34	8	Rear Panel AC Power Connections _____	15
DIGITAL INPUT Button 12 40 / INPUT LEDs 15	8	AC Power cord 28	15
5.1 CH Button 13 39	8	AC Outlets 25	15
SURROUND MODE LEDs 17	8	RSP-975 Specifications _____	15
SURROUND MODE Button 14 32	9		
INPUT LEVEL Buttons 16	9		
MUTE LED 10	9		
PEAK LED 9	9		
REMOTE LED 8	9		
DYNAMIC RANGE LED 6	9		
DIGITAL LOCK LED 11	9		
RR-939 Remote Control _____	9		
Programming the RR-939	10		
POWER Switch 30	10		
MASTER VOLUME Controls 29	10		
SELECTOR Buttons 34	10		
5.1 Button 39	10		
MUTE Button (remote only) 31	10		
SELECT Button (Digital Input) 40	10		
SURROUND + Button 32	10		
SURROUND DELAY Button (remote only) 38	10		
CENTER DELAY Button (remote only) 36	11		
DYNAMIC Button (remote only) 37	11		
BACK/BALANCE CHECK (remote only) 41	11		
ENTER/OUTPUT BALANCE (remote only) 42	11		
RECALL Button 33	11		
ON-SCREEN Button (remote only) 35	11		

About Rotel

A family whose passionate interest in music led them to manufacture high fidelity components of uncompromising quality founded Rotel over 30 years ago. Through the years that passion has remained undiminished and the family goal of providing exceptional value for audiophiles and music lovers regardless of their budget, is shared by all Rotel employees.

The engineers work as a close team, listening to, and fine tuning each new product until it reaches their exacting musical standards. They are free to choose components from around the world in order to make that product the best they can. You are likely to find capacitors from the United Kingdom and Germany, semi conductors from Japan or the United States, while toroidal power transformers are manufactured in Rotel's own factory.

Rotel's reputation for excellence has been earned through hundreds of good reviews and awards from the most respected reviewers in the industry, who listen to music every day. Their comments keep the company true to its goal - the pursuit of equipment that is musical, reliable and affordable.

All of us at Rotel, thank you for buying this product and hope it will bring you many hours of enjoyment.

Getting Started

Thank you for purchasing our RSP-975 Digital Surround Sound Processor. The RSP-975 is a full-featured audio/video processor designed to decode both analog and digital surround sound signals including Dolby Pro Logic and 5.1 channel Dolby Digital sources. It will provide accurate reproduction of both movie soundtracks and demanding musical selections and is a natural extension of our well-known passion for good sound.

To get the most from your RSP-975, we suggest you read this manual and keep it as a reference to answer any future questions.

RSP-975 Key Features

- *Rotel's "Balanced Design" approach combines advanced circuit board layout, comprehensive parts evaluation, and extensive listening tests for superior sound and long term reliability.*
- *Dolby® Pro Logic® decoding for analog sources*
- *Dolby Digital® decoding for 5.1 channel digital sources*
- *5.1 channel input for DTS® adaptor and/or future upgradeability*
- *User friendly operation with On-Screen Display.*
- *Comprehensive digital and analog input and output connections for audio and video sources.*

Unpacking the RSP-975

Your RSP-975 underwent quality control tests before we sent it on its way to you and should perform perfectly out of the box.

Remove the unit carefully from its packing. Look for the handheld remote controller and other accessories. Save the packing and box if possible as it will protect the RSP-975 if you move or need to return it to us for maintenance.

Placement

Place the RSP-975 on a solid, dry, level surface away from direct sunlight, excessive heat, high humidity, or strong vibrations.

Make sure the RSP-975 is close to the other components in your audio/video system as that makes initial hookup and any subsequent troubleshooting easier.

If at all possible, put the RSP-975 on its own shelf. This makes initial cable routing, hookup, and any subsequent system changes easier. It also minimizes potential interference or heat buildup from other components.

Make sure there is enough room behind the RSP-975 for easy hookup. Remember, you're connecting many other components to this unit and you'll probably need more space than you think.

Don't stack other objects (components or other items) on top of the RSP-975. Don't let water fall into the RSP-975 as this could damage delicate circuitry.

Front Panel Controls

We suggest you look over the RSP-975's front and rear panels before you start connecting other components to it. The following explanations will help you get familiar with the units connections, features, and controls, with number references corresponding to the illustrations at the front of this manual.

Most functions are duplicated on the front panel and on the handheld remote control shipped with your unit. A few may be available only on one or the other. When two reference numbers appear, one refers to the location of the button on the front panel, the other to the location of the button on the handheld remote control.

STANDBY Switch 1 30 and STANDBY LED 2

The RSP-975 is similar to many TV sets in that some of its circuitry (the central microprocessor, infrared sensor, etc.) remains powered at all times while the rest of the circuitry is turned on or off by the user.

The STANDBY switch turns the RSP-975 from standby mode to fully active mode. If only the STANDBY LED is lit, the unit is in standby mode.

Push the front panel STANDBY button (or the handheld remote POWER button) to fully activate the RSP-975. You'll see other LEDs light up and the STANDBY LED will go out. Push the STANDBY switch again to deactivate the RSP-975.

Note: The STANDBY switch controls the rear panel AC outlet. When the RSP-975 is in standby mode the AC outlet is also off. When the RSP-975 is fully functional, the AC outlet is live.

Remote Sensor 7

This sensor receives infrared signals from the handheld remote control. Make sure you do not accidentally block this sensor with cables or accessories.

MASTER VOLUME Control 3 29

The MASTER VOLUME knob is an electronic rotating control. Turn it clockwise to increase the volume; counterclockwise to decrease. MASTER VOLUME buttons are also available on the RSP-975's handheld remote control.

VOLUME Display 4

As you adjust the volume, a digital display located above the control will provide a volume indication in one decibel steps with +12dB being maximum output level and -67dB being minimum.

TONE Controls 18

BASS and TREBLE controls increase and decrease the audio signal's low and high frequency content. Rotate each one clockwise to increase output in the respective frequency range and counterclockwise to reduce it. The center detent removes each control from the audio path for maximum signal integrity.

LISTENING SOURCE Buttons 5 34

Eight large front panel LISTENING buttons allow you to select an audio or video source component such as CD, TUNER, VCR, DVD, etc. Simply push any of these buttons to select an input source. (The handheld remote has functionally identical buttons.) You will hear this source and, if you have selected a video source, see its picture on your TV monitor. An LED indicator on each pushbutton lights to confirm your selection.

Note: As delivered from the factory, pushing one of these buttons activates the **analog** audio inputs for each component. However, to accommodate digital signals available from many source components (such as CD players and Dolby Digital DVD players), the RSP-975 also provides four **digital** inputs which may be used instead. See below.)

DIGITAL INPUT Button 12 40 / INPUT LEDs 15

In addition to analog audio inputs for each of eight source components, the RSP-975 provides DIGITAL INPUTS for up to four digital audio sources. These four DIGITAL INPUTS can be assigned to any of the eight LISTENING inputs

The DIGITAL INPUT button allows you select one of these digital inputs to use in place of the ANALOG INPUT for each LISTENING SOURCE SELECT button. For example, if you have a DVD player, you can connect the DVD player's digital output to the DVD DIGITAL INPUT and then tell the RSP-975 to use the digital signal in place of the analog signal.

To select a DIGITAL or ANALOG input for a given LISTENING SOURCE input:

- Select the desired LISTENING SOURCE input.
- Repeatedly press the DIGITAL INPUT button to sequentially step through the available digital inputs (OPTICAL/COAX1/COAX2/DVD/ANALOG). Stop when the desired INPUT LED lights.

NOTE: The DIGITAL or ANALOG INPUT is immediately memorized as it is selected and will be automatically activated when you select that LISTENING SOURCE SELECTOR button in the future.

5.1 CH Button 13 39

This button overrides all other input selectors (both analog and digital) and directly connects an external adaptor (such as Rotel's RDA-986 DTS Processor) to the RSP-975's MASTER VOLUME control. This allows the RSP-975 to remain the central controller for even the most advanced audio/video systems. When activated, all of the RSP-975's inboard Dolby processing is bypassed.

SURROUND MODE LEDs 17

The RSP-975 provides three different surround sound modes to accommodate different types of audio and video source material as described below. These LEDs tell you which surround sound mode you've selected. Here is a brief description of the various surround modes.

STEREO is a conventional 2-speaker stereo direct bypass mode with no surround sound or other processing. The FRONT LEFT speaker, the FRONT RIGHT speaker, and the SUBWOOFER (if present) are on; all other speakers are off.

DOLBY DIGITAL provides proper playback decoding processing for any discrete 5.1 channel Dolby Digital encoded digital audio source such as an AC-3 Laser Disc or DVD disc. Dolby Digital provides the highest level of surround sound performance with 5 channels of discrete surround information plus subwoofer. Dolby Digital is only available when using one of the DIGITAL inputs. It is not available for ANALOG inputs.

DOLBY PRO LOGIC provides proper playback decoding and processing for any Dolby Surround encoded analog audio source, whether it be a music CD, videotape, videodisc, conventional stereo TV broadcast, or satellite broadcast. Dolby Pro Logic processing and playback through a properly calibrated system will preserve the directionality, ambiance, and spatial effects intended by the source's producers. Dolby Pro Logic can also provide excellent surround sound playback of musical recordings.

SURROUND MODE Button 14 32

The SURROUND MODE button is used to select one of three surround modes (Dolby Pro Logic, Dolby Digital, or Stereo) as described in the section immediately above. **To make a selection, press the SURROUND MODE button. Each time you press the button, the mode will cycle to the next available setting as indicated by the SURROUND MODE LEDs.**

NOTE: If an ANALOG input is selected, the only available surround mode options are DOLBY PRO LOGIC and STEREO. All three options are available for DIGITAL inputs.

The surround mode selection for ANALOG inputs (STEREO or DOLBY PRO LOGIC) is memorized as soon as it is made for each LISTENING INPUT and will be automatically engaged the next time that LISTENING INPUT is selected.

The surround mode setting for DIGITAL INPUTS is not memorized and is only a temporary override as long as that LISTENING INPUT is activated.

Every time a DIGITAL INPUT is selected, the surround mode setting will default to DOLBY DIGITAL. If a digital signal is detected that is not DOLBY DIGITAL, the mode will automatically switch to DOLBY PRO LOGIC. [???? Is this auto-sensing in the RSP-975?]

INPUT LEVEL Buttons 16

These two pushbuttons allow you to adjust the level of each source component so that the volume level remains relatively constant when switching between source components.

NOTE: The INPUT LEVEL adjustments only effect the ANALOG input for each source. They have no effect on the DIGITAL inputs.

To reduce the input level of the selected source, press the INPUT LEVEL < button. To increase the level of the selected source press the INPUT LEVEL > button. As the setting is adjusted, the VOLUME DISPLAY changes to show the INPUT LEVEL. The range of the adjustment is from 0dB (full gain) to -12dB.

The setting is memorized as soon as it is made so that it will automatically be recalled whenever that source component is selected.

Note: For optimum performance, it is important not to set the source input levels so high that the signal overloads the RSP-975's input circuitry. If the PEAK LED on the front panel is repeatedly flashing, adjust the input level for that source downward.

MUTE LED 10

This front-panel LED lights to indicate that the output of the RSP-975 has been muted from handheld remote control.

PEAK LED 9

This front-panel LED lights to indicate that the input signal of the selected source may be overloading the input circuitry of the RSP-975. Momentary occasional flashes of this LED on signal peaks are acceptable. However, if the LED repeatedly or continuously lights, you should reduce the input level for that source.

REMOTE LED 8

This front-panel LED lights to indicate that a command is being received from the handheld remote control.

DYNAMIC RANGE LED 6

Today's digital sources are capable of extremely high dynamic range (the difference between the softest and loudest sounds). In some cases, the available dynamic range may tax the amplifiers or speakers. In other cases, it may be desirable to reduce the dynamic range, for example, when listening at low volume levels. The RSP-975 provides the capability to reduce the dynamic range in three progressive steps (25% / 50% / 75% reduction) with a pushbutton on the handheld remote control. See the Remote Control section of this manual for details.

This front-panel LED lights to indicate that the dynamic range has been reduced.

DIGITAL LOCK LED 11

The RSP-975 digital circuitry can lock onto digital signals with a number of different sampling rates. The DIGITAL LOCK LED lights to indicate that the digital circuitry has recognized and locked onto a digital signal.

RR-939 Remote Control

The RSP-975 includes a handheld remote control that does far more than operate the RSP-975. The RR-939 is a full-function programmable remote control that can operate 8 A/V components.

A separate manual, included with the remote, gives detailed information on programming and using the RR-939 to replace all of the remote controls in your system. This section is intended to provide only that information which pertains to the use of the RR-939 to operate the RSP-975.

Note: Many functions duplicate the RSP-975 front panel controls and are listed here only for your reference. Please refer to the previous Front Panel Controls section of this manual if you need additional information.

To operate the RSP-975 with the remote, make sure that the AUDIO mode is active by pressing the AUD button on the remote before you start. If it is active, pressing command keys on the RR-939 will cause the AUDIO button to flash red. Once the AUDIO mode is active, it will stay active unless you press one of the other DEVICE buttons to control a different component.

Programming the RR-939

The RR-939 is preprogrammed from the factory to operate the RSP-975. Should the AUDIO command set on your RR-939 not operate the RSP-975, it's possible that the programming had been inadvertently changed. To reprogram the remote to operate the RSP-975:

1. Press the AUDIO button at the top of the remote while simultaneously pressing the MUTE button and hold both for at least one second. The AUDIO button will light in red for 20 seconds, indicating that you have entered the program mode. The next step must be done within this 20 second period, or the RR-939 will revert to its standard operating mode.
2. Use the NUMERIC buttons to enter the 3-digit code (001) for the RSP-975 – press 0, then 0, then 1. The AUDIO button will flash each time you enter a digit.
3. Store the code number by pressing the corresponding AUDIO button again. The button will blink twice to confirm the storage of the code in memory.

POWER Switch 30

Duplicates the function of the Standby Switch on the front panel. Press to activate the RSP-975. Press again to deactivate.

MASTER VOLUME Controls 29

A pair of buttons which duplicate the function of the front panel volume control. Press VOLUME DOWN to reduce the volume and press VOLUME UP to increase the volume.

The VOLUME UP/DOWN buttons are also used in making certain system configuration settings.

SELECTOR Buttons 34

A group of ten buttons which duplicate the function of the LISTENING SOURCE SELECTOR buttons on the RSP-975 front panel. Select any input source by pressing the appropriate button.

The labels on the remote buttons match the front panel buttons, except that the button labelled PHONO/LD corresponds to the front panel DVD input button and the button labelled AUX 1 corresponds to the front panel AUX input button. The remote buttons labelled AUX 2 and TAPE 2 are not used with the RSP-975.

5.1 Button 39

Duplicates the 5.1 CH button on the front panel. Selects the 5.1 Channel input, overriding any other sources.

MUTE Button (remote only) 31

Push this button once to reduce the output levels to zero – to turn the sound off. The front panel MUTE LED will light. Press the MUTE button again to restore the prior volume level.

SELECT Button (Digital Input) 40

Duplicates the DIGITAL INPUT button on the front panel. Selects the ANALOG input or one of the DIGITAL inputs for the currently selected source.

SURROUND + Button 32

Duplicates the function of the front-panel SURROUND MODE button. Steps sequentially through various surround sound operating modes. Your current selection will be indicated by front panel LEDs and will be memorized for ANALOG inputs.

SURROUND DELAY Button (remote only) 38

The surround processing in the RSP-975 delays the signal sent to the rear surround speakers as a means of simulating a larger physical space (such as a movie theater or concert hall) and to ensure that sounds from the front speakers reach your ear first. The SURROUND DELAY button steps sequentially through four available settings for your selected surround mode (not applicable in STEREO modes).

NOTE: *The SURROUND DELAY setting is system-wide. Changing it will increase or decrease the relative delay time for all inputs and both surround modes. The setting is automatically memorized as it is made.*

You will get visual confirmation of your delay time setting on the VOLUME DISPLAY as you adjust the setting. The delay time setting also appears in the ON-SCREEN DISPLAY (see below).

There are no hard and fast rules for setting proper delay times. Many listeners will be satisfied with the default settings. Others will want to experiment. In the end, it is a matter of personal taste.

In general, longer delay time settings will tend to create the illusion of a larger acoustic space, although if overdone, the effect can be exaggerated and unnatural. Longer delay settings may typically be more spectacular. Shorter delay times may be more natural.

Delay times also may need to be adjusted depending on the relative distance from the listening position to the front and rear speakers. As a general rule, your attention should never be drawn to the surround speakers as a primary sound source, particularly when listening to music. If you are closer to the rear speakers, increasing the delay time may prevent this problem.

The four DELAY TIME choices for each surround mode are:

	STEP 1	STEP 2	STEP 3	STEP 4
STEREO:	NONE	NONE	NONE	NONE
DOLBY PRO LOGIC:	15 ms	20 ms	25 ms	30 ms
DOLBY DIGITAL:	NONE	5 ms	10 ms	15 ms

Again, experimentation will show you which settings are best for your source material, room conditions, and system setup.

CENTER DELAY Button (remote only) 36

The CENTER DELAY button works like the SURROUND DELAY button above, except that it increases the delay the center channel speaker, if present. **CENTER DELAY is only available in Dolby Digital surround mode.** The CENTER DELAY button steps sequentially through five available settings (0, 1, 2, 3, 4, 5 ms).

NOTE: The CENTER DELAY setting is system-wide. Changing it will increase or decrease the relative delay time for all inputs in Dolby Digital surround mode. The setting is automatically memorized as it is made.

You will get visual confirmation of your delay time setting on the VOLUME DISPLAY as you adjust the setting. The delay time setting also appears in the ON-SCREEN DISPLAY (see below).

DYNAMIC Button (remote only) 37

This button is used to reduce the dynamic range to accommodate program material that could tax your system or for low-volume listening. This feature is only available in Dolby Digital surround mode.

Press the button repeatedly to step through the four available settings: NONE (full dynamic range), 25% reduction, 50% reduction, and 75% reduction. While making the adjustment, the setting will appear in the VOLUME display. The setting is also shown in the ON-SCREEN DISPLAY (see below).

A front-panel LED lights to indicate that the dynamic range has been reduced.

BACK/BALANCE CHECK (remote only) 41

The BACK button on the remote control is used during initial calibration of relative speaker volume levels. Generally, it is only used during initial setup of the system and not during normal operation.

To enter the BALANCE CHECK calibration, press and hold the BACK button for 2 seconds. The following screen will appear on your TV monitor, for adjusting the relative volume levels of the front, center, and rear speakers, along with the subwoofer.

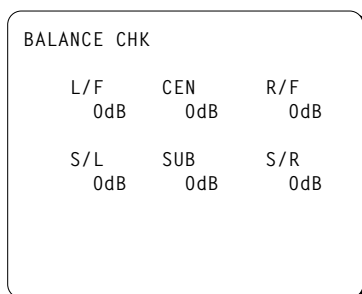

When the menu appears, the L/F speaker label will be flashing and you will hear a test tone coming from that speaker. You can select the other speakers by sequentially pressing the BACK button. The test tone will shift accordingly to the selected speaker. The menu

will disappear after all six speakers have been highlighted and you may need to re-enter the menu by pressing and holding the BACK button.

While seated in the normal listening location, switch the test tone to the various speakers and listen to hear if any are noticeably louder or quieter than the front speakers. If so, adjust the quieter speakers volume levels up or down to match the louder speakers using the VOL UP/DOWN remote buttons, while the speaker you wish to adjust is highlighted. Continue switching among the speakers and adjusting until all of the speakers are approximately the same volume (or to suit your listening preference).

This setting will be memorized when you leave the menu and will become the system-wide default setting.

ENTER/OUTPUT BALANCE (remote only) 42

The ENTER button on the remote control has a similar function to the BALANCE CHECK calibration described above, except that its adjustments are temporary and apply only to the selected source input. As soon as you select a different source, the settings revert to the system-wide defaults as set during the BALANCE CHECK calibration.

NOTE: Although these adjustments can be made directly using the ENTER button, we strongly recommend that you only make these adjustments from the ON-SCREEN DISPLAY system. For this reason, the instructions are included in the section on the ON-SCREEN DISPLAY (see below).

RECALL Button 33

You can temporarily reset the OUTPUT BALANCE settings to 0dB for all speakers at any time by pressing the RECALL button on the remote control. The memorized system-wide settings will be activated when you switch to a different LISTENING SOURCE input.

ON-SCREEN Button (remote only) 35

Push this button to turn on the ON-SCREEN DISPLAY. If the ON-SCREEN DISPLAY is already visible, push this button once or twice to cancel the display. See next section for details.

The On-Screen Display

The RSP-975 features two ON-SCREEN DISPLAY screens to help operate the system. These screens are available at any time by pressing the ON-SCREEN MENU button on the remote control to activate the first screen. Push the button a second time to go to the second screen (OUTPUT BALANCE). Push the button a third time to cancel the ON-SCREEN DISPLAY.

MAIN Screen

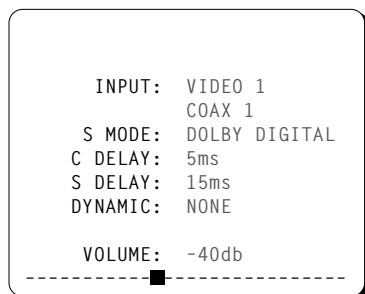

The MAIN menu provides status information and configuration options for the source inputs and other system parameters. Some of the items shown above will not be available for all surround modes. For example, C DELAY and DYNAMIC will only appear in DOLBY DIGITAL mode.

INPUT: Two lines showing the currently selected input source and the audio input for that source. Change the source using the LISTENING SOURCE SELECT buttons on the front panel or remote. Change the audio input using the DIGITAL INPUT button on the front panel or the SELECT button on the remote.

S MODE: The currently selected surround mode. Change using the SURROUND MODE front panel button or the SURROUND + button on the remote.

C DELAY: The current center channel delay setting, only shown in Dolby Digital surround mode. Adjust using the C DELAY button on the remote.

S DELAY: The current surround delay setting, only shown in Dolby Digital and Dolby Pro Logic surround modes. Adjust using the SUR DELAY button on the remote.

DYNAMIC: The dynamic range setting, only shown in Dolby Digital surround mode. Adjust using the DYNAMIC button on the remote.

5.1 CH INPUT: whether or not the 5.1 channel input is active

VOLUME: Duplicates the front panel VOLUME display, along with a bar graph volume indication. Adjust using the VOLUME controls on the front panel or remote.

Press the ON-SCREEN MENU button a second time to go to the next screen:

OUTPUT BALANCE Screen

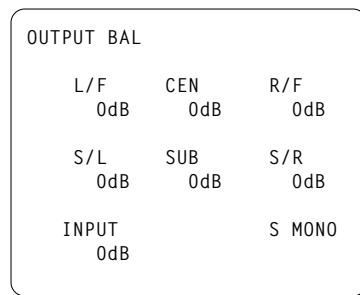

The OUTPUT BALANCE screen provides a temporary adjustment to the relative output levels of each speaker in the system. Unlike the BALANCE CHECK calibration procedure, the changes made on this screen are temporary. They change the output balance only for the current source input and only until a different source is selected, when the settings will revert to the system-wide default established during the BALANCE CHECK calibration.

SPEAKER OUTPUT LEVELS: The main portion of the screen consists of labels for each of the speakers in the system, along with an output level setting. The screen above shows ALL possible speakers as would appear in a full system in Dolby Pro Logic mode. Depending on your system configuration and surround mode setting, you will see a smaller complement of speakers. For example, in STEREO mode, you will only see FRONT speakers (and the SUBWOOFER, if your system is configured for a subwoofer).

To adjust the output of your speakers:

1. Press the ENTER button on the remote. The first speaker label will flash. Adjust its output level up or down with the VOLUME controls on the front panel or remote.
2. Press the ENTER button on the remote again to move to the next speaker. Adjust its output level, and press the ENTER button again to continue the process until all speakers have been adjusted.
3. Press the ENTER button on the remote again to move to the next speaker. Adjust its output level, and press the ENTER button again to continue the process until all speakers have been adjusted.
4. Once you've started adjusting, the screen will return to the MAIN screen after 5 seconds of inactivity or when you press ENTER after the final speaker.

NOTE: You can reset the temporary OUTPUT BALANCE settings to 0dB for all speakers at any time by pressing the RECALL button on the remote control.

S MONO: This indication appears in the screen only in DOLBY PRO LOGIC surround mode to indicate that the surround speakers reproduce a mono signal in this mode.

INPUT: This indication appears only when an ANALOG source input is selected. It shows the current INPUT LEVEL setting for the active source input and can be adjusted with the front panel INPUT LEVEL buttons. This change is not temporary. It is memorized and will be recalled each time that source input is selected.



Rear Panel Input Connections

This section of the manual provides complete information on all of the audio and video signal input connections on the rear panel of the RSP-975. For convenience, each topic begins with an overview of the particular connection, followed by detailed hookup instructions.

Note: DO NOT plug any system component into an AC source until system hookup is complete. Wait to apply power until you're confident that all component-to-component connections have been properly made.

All video and digital audio cables should have a 75 ohm impedance rating. Because the video and digital cable standards are as close as they are, you can safely use a video cable for digital audio data transmission and, conversely, a digital audio cable for video data transmission. We strongly advise that you NOT substitute a conventional analog audio interconnect cable for either digital or video.

Source Inputs 26

These eight sets of RCA-type inputs (TUNER, CD, TAPE, AUX, DVD, VIDEO 1, VIDEO 2, and VIDEO 3) accept line level audio and composite video signals from source components. The first four inputs are audio-only, the other four source inputs accept both left and right channel audio plus a video signal.

All RCA-type connections on the RSP-975 follow these standard color codes:

- Left channel audio = RCA jack with white inset
- Right channel audio = RCA jack with red inset
- Composite video = RCA jack with yellow inset

Connect the OUTPUTS of your source components to the appropriate INPUTS on the RSP-975. For example, if your system includes a CD player, connect its left and right channel analog outputs to the RSP-975's CD inputs. If your system includes a video source, connect its analog audio outputs to one of the RSP-975's VIDEO audio inputs and its video composite RCA output to the corresponding composite RCA video input.

Digital Inputs 24

The RSP-975 features a D/A conversion capability which allows it to accept digital input signals from source components. These include digital signals from CD players, satellite TV receivers, and 5.1 channel Dolby Digital signals from DVD players. The D/A automatically senses and adjusts to the correct sampling rates.

To take full advantage of the built-in digital decoding capability, the RSP-975 accepts digital signals from up to four different source components in a number of formats. The digital inputs are as follows:

OPTICAL: This input allows connection of a standard optical digital output from a CD player or other source component. Requires an optical digital cable.

COAX 1 and COAX 2: Two standard coaxial digital connectors for use with the digital output of any component (CD player, Satellite TV, etc.)

DVD: Standard coax digital connection for use with Dolby Digital DVD players.

To use the digital inputs, simply connect the appropriate cable from the digital output of your source component to the corresponding digital input on the RSP-975.

It is necessary to select the appropriate digital (or analog) input for each component. Once the selection is made, it is memorized so that simply selecting a SOURCE INPUT activates the appropriate audio input. This procedure is detailed in the DIGITAL INPUT button section of this manual.

5.1 CH INPUT 20

This 25-pin input connects six discrete channels of analog information from an outboard processor (DTS, for example).

External adaptors may provide both RCA and DB25 outputs. We suggest that you use a DB25-to-DB25 cable to reduce the number of cables and to insure proper channel-to-channel continuity.

If your external adaptor does not have a DB25 output, you will need to purchase a multi-RCA to DB25 adaptor cable from your Rotel retailer. Make sure to observe proper channel continuity.

REMOTE EXTERNAL IN Jack 22

This 3.5 mm jack accepts a remote infrared sensor which duplicates the function of the front panel IR sensor in installations where the front panel sensor could be blocked by a cabinet. See your authorized Rotel dealer for a selection of remote sensors that will work with your RSP-975.



Rear Panel Output Connections

This section of the manual provides complete information on the audio and video signal output connections on the rear panel of the RSP-975 which are used for routing the output signals to a television monitor, audio amplifiers, and recording devices. For convenience, each topic begins with an overview of the particular connection, followed by detailed hookup instructions.

Source Outputs 26

Four of the input sources have corresponding sets of RCA output connections for routing the signal of the RSP-975 to audio or video tape recorders for recording.

TAPE provides a stereo pair of audio outputs. Connect standard RCA cables from the LEFT and RIGHT outputs to the LEFT and RIGHT record inputs on your audio tape recorder.

VIDEO 1, VIDEO 2, AND VIDEO 3 include left and right channel audio plus composite coax video output from the RSP-975 to VCRs or other components (VCR, etc.) for recording. Standard color coding applies.

Connect the RSP-975's VIDEO 1 left and right audio outputs to the audio inputs of the first source component. Then, connect the VIDEO 1 composite video output to the video input of the same source component. Repeat these steps for Video 2 and Video 3 connections, if necessary/

Once properly connected, whatever input signal is selected by the LISTENING INPUT SOURCE buttons is available for recording at any or all of the output connections.

NOTE: Only analog audio signals are available at the record outputs. Therefore, even if you choose to use digital signals from your source components, you should also connect their analog signals to the RSP-975, for recording purposes.

Main Audio Outputs 27

These six outputs (LEFT FRONT, CENTER FRONT, RIGHT FRONT, LEFT SURROUND, RIGHT SURROUND, and SUBWOOFER) connect the RSP-975's main audio output to a multichannel power amplifier or multiple power amplifiers for the primary listening area via six individual RCA-style jacks.

Standard color coding applies with black insets to distinguish center channel and subwoofer outputs from left (white) and right (red) Front and Rear outputs.

To hook up the RCA main audio outputs, connect a standard audio cable from each output to the input of the amplifier channel that will power the corresponding speaker. In a full home theater system, you will need to make six different connections corresponding to the six speakers (LEFT FRONT, CENTER FRONT, RIGHT FRONT, LEFT SURROUND, RIGHT SURROUND, and SUBWOOFER).

It is important to make sure that you have the correct output connected to the proper amplifier channel. Take your time.

MONITOR TV Output 21

The video output of the RSP-975 sends the video signal to your TV monitor from an RCA-type composite video connection. Simply connect the MONITOR TV output to a video input on your television monitor, using a standard RCA composite video cable. Whatever signal is selected on the RSP-975 will appear on screen.

Rear Panel Configuration Switches

The RSP-975 has five switches that must be set according to your particular system configuration. Details follow:

NTSC/PAL Video Switch 23

There are two different video standards used in different parts of the world. In the United States, broadcast TV and video components adhere to the NTSC standard. In Europe, the PAL standard is more common. These differ in their technical details (scanning frequency, etc.) and are not interchangeable.

You must set the rear panel switch to match the video standard in your country. If set incorrectly, the video signal sent to your TV monitor will be unrecognizable.

SPEAKER CONFIGURATION Switches 19

There are four speaker configuration switches on the RSP-975's rear panel — CENTER (small/none/large), FRONT (small/large), REAR (small/large), and SUB (on/off). These switches let you customize the RSP-975's main outputs to precisely match system configuration and speaker capabilities.

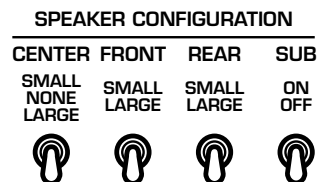

These switches are crucial to proper system configuration and must be adjusted so that you enjoy all the performance your system can deliver.

Home theater speaker systems vary considerably in their size and performance, particularly in their bass output. For this reason, today's surround sound processors feature elaborate logic which can send thunderous bass information from movie soundtracks to the speaker(s) best able to handle it – subwoofers and/or large speakers. For optimum surround sound performance, it is necessary to tell the RSP-975 what speakers your system includes and what type they are.

The following configuration instructions refer to LARGE and SMALL speakers. The size refers more to the bass performance of the speaker than its physical size. A full-range speaker that has extended bass response is considered LARGE. A compact minispeaker with limited bass response or power handling is considered SMALL.

While understanding the terms LARGE and SMALL is useful, it is probably more important to understand what these different speaker types mean in terms of *system* performance. This will help determine how you should configure your system. **In a nutshell, the system will redirect bass information away from SMALL speakers and send it to the LARGE speakers and/or the SUBWOOFER in your system.**

Things become a little more complex in systems with a subwoofer. **For example, the system will generally not redirect bass information away from a LARGE speaker to the subwoofer.** Thus, the decision you need to make when confronted with a choice of LARGE or SMALL is whether or not you want the particular speaker to play the deep bass information or whether you would prefer that the deep bass information be sent to the subwoofer. If you have invested in a robust subwoofer for your system, you might very well decide to send all of the bass to it, regardless of how capable the other speakers in the system may be. In this case, you would tell the RSP-975 that all of your speakers are SMALL, without regard to how big they may actually be.

An alternative configuration for setting up front SMALL speakers with a subwoofer would be to follow the speaker manufacturer's instructions, wiring the SMALL speakers to the subwoofer's crossover and then connecting the subwoofer directly to the front speaker connection terminals. In this arrangement, the speakers would be classified as LARGE and the subwoofer setting would be OFF for all surround modes. No information will be lost during playback because the system knows to redirect the bass information to the front LARGE speakers. This configuration may be optimal for many users as it can improve the way the bass integrates into the listening room and ensure correct satellite speaker operation by using the speaker manufacturer's own crossovers.

The following speaker options are available:

FRONT SPEAKERS (small/large): This menu setting determines what kind of main front left and right speakers you are using. Use the LARGE setting if your main left and right speakers are full range designs with good bass response capability. If you are using minispeakers or if you want the bass from these speakers to go to a subwoofer instead, use the SMALL setting.

CENTER SPEAKER (small/large/none): Use the LARGE position if your system's center channel speaker is capable of full-range, extended bass response. Use the SMALL position if your center channel speaker has more limited low frequency capability, or if you prefer that the bass be sent to the subwoofer. Select the NONE setting if your system does not have a center channel speaker.

REAR SPEAKERS (small/large): If your rear surround speakers are capable of sustained low frequency output, select the LARGE setting. If your rear speakers have limited bass capability or if you prefer that the bass go to a subwoofer, use the SMALL setting.

SUBWOOFER (yes/no): Use the YES setting if your system has a subwoofer. If your system does not have a subwoofer, select the NO setting.

AC Outlets 25

These two outlets let you plug AC cords from source components or other accessories into the back of the RSP-975 so that they will be turned on and off automatically. The outlets are powered whenever the RSP-975 is fully active and are off when the RSP-975 is in STANDBY mode.

***Note:** We DO NOT RECOMMEND that you use this outlet for a power amplifier. Do not exceed the maximum 800 watt capability of these switched outlets.*

RSP-975 Specifications

Audio

Frequency Response:	5 Hz - 20 kHz, + 0.5 dB
Signal to Noise Ratio (IHF "A"):	100 dB (front) 70 dB (surround)
Input Impedance:	47 k Ohms
Output Impedance:	500 ohms
Total Harmonic Distortion:	0.03 % (@1 kHz)
Intermodulation Distortion:	0.03 % (400 Hz/7 kHz, 4:1)
Output	
Maximum:	> 6 volts
Dolby, 300 mV in:	0.9 volt

Video

Frequency Response:	3 Hz-10 MHz, - 3 dB
Signal to Noise Ratio:	- 60 dB
Input Impedance:	75 ohms
Output Impedance:	75 ohms
Output level (peak to peak):	1 volt

General

Power Consumption:	30 watts
Power Requirements (AC):	115 volts 50/60 Hz or 230 volts 50/60 Hz
Weight:	8 Kg/17.6 lb.
Dimensions (W x H x D):	440 x 110 x 316 mm 17.38" x 5" x 12.43"

All specifications are accurate at the time of printing. Rotel reserves the right to make improvements without notice. Rotel and the Rotel HiFi logo are registered trademarks of The Rotel Co, Ltd., Tokyo, Japan. DTS is a registered trademark of Digital Theater Systems.

Manufactured under license from Dolby Laboratories Licensing Corporation. "Dolby", "Pro Logic", and the double-D symbol are trademarks of Dolby Laboratories Licensing Corporation. Confidential unpublished works © 1992 - 1997 Dolby Laboratories, Inc. All rights reserved.

Rear Panel AC Power Connections

AC Power cord 28

Your RSP-975 is configured at the factory for the proper AC line voltage in the country where you purchased it (either 115 volts AC or 230 volts AC with a line frequency of either 50 Hz or 60 Hz). The AC line configuration is noted on a decal on the back of your unit.

RSP-975

DIGITAL SURROUND SOUND PROCESSOR

The Rotel Co. Ltd.

10-10 Shinsen-Cho
Shibuya-Ku
Tokyo 150-0045
Japan

Phone: +81 3-5458-5325
Fax: +81 3-5458-5310

Rotel of America

54 Concord Street
North Reading, MA 01864-2699
USA

Phone: +1 978-664-3820
Fax: +1 978-664-4109

Rotel Europe

Meadow Road
Worthing, West Sussex BN11 2RX
England

Phone: +44 (0)1903 524 813
Fax: +44 (0)1903 524 831

Rotel Deutschland

Kleine Heide 12
D-33790 Halle/Westf.
Germany

Phone: +49 05201-87170
Fax: +49 05201-73370

ROTEL*hi-fi*

ROTEL*hi-fi*

ROTEL*hi-fi*

ROTEL*hi-fi*

ROTEL*hi-fi*

ROTEL*hi-fi*

ROTEL*hi-fi*

ROTEL*hi-fi*

ROTEL*hi-fi*

ROTEL*hi-fi*

ROTEL*hi-fi*

ROTEL*hi-fi*

ROTEL*hi-fi*

ROTEL*hi-fi*

ROTEL*hi-fi*

ROTEL*hi-fi*

ROTEL*hi-fi*

ROTEL*hi-fi*

ROTEL*hi-fi*

ROTEL*hi-fi*