

High Efficiency Backlight LED Driver

General Description

The RT4501/A is a high-efficiency LED driver for backlight applications. An asynchronous boost converter with an internal Schottky diode and a current source driver are designed to support 6LED/channel with wide input voltage range from 2.5V to 5.5V.

An I²C interface can provide easy backlight control in fast and high speed mode. The RT4501 supports linear mappings with 256 steps to setup the brightness of backlight LEDs. It also supports PWM dimming to adjust the brightness.

For brightness dimming, the RT4501A supports 128 steps pulse dimming which determines the LED current, and RT4501 support 256 steps PWM dimming which determines the LED current.

The RT4501/A provides complete protection functions such as input under-voltage lockout, over-current, output over-voltage and over-temperature protection. The OVP threshold voltage can be set at 16V and 25.5V for different applications. The RT4501/A is available in the WL-CSP-10B 0.87x2.07 (BSC) package.

Features

- Input Voltage Range : 2.5V to 5.5V
- Internal Schottky Diode
- Fast-speed mode I²C Compatible Interface
- Drive Up to 7 WLEDs in 2 String
- External PWM/Pulse Brightness Control
- 550k/1.1MHz Switching Frequency
- Built-in Internal Soft-Start
- PWM Dimming/Pulse Dimming Resolution 256/128 Steps
- I²C Programmable 256 Steps Linear Current Regulation
- Up to 85% Efficiency with Small Magnetics
- Programmable 16V/25.5V OVP
- Current Accuracy $\pm 5\%$ and Current Balance $\pm 3\%$
- UVLO, OVP, OCP, OTP Protection
- Shutdown Current : $< 1\mu\text{A}$
- Temperature Range : -40°C to 85°C
- RoHS Compliant and Halogen Free

Applications

- Cellular Phones
- Digital Cameras
- PDAs and Smart Phones
- Portable Instruments

Simplified Application Circuit

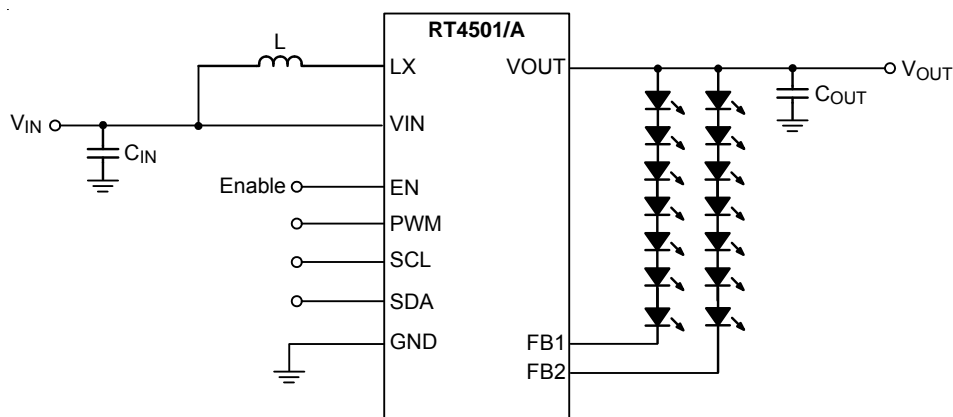

Ordering Information

RT4501/A □

- Package Type
WSC : WL-CSP-10B 0.87x2.07 (BSC)
- RT4501 : PWM Dimming
- RT4501A : Pulse Dimming

Note :

Richtek products are :

- ▶ RoHS compliant and compatible with the current requirements of IPC/JEDEC J-STD-020.
- ▶ Suitable for use in SnPb or Pb-free soldering processes.

Pin Configurations

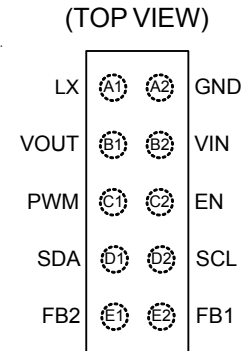

WL-CSP-10B 0.87x2.07(BSC)

Marking Information

RT4501WSC

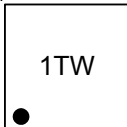

1T : Product Code
W : Date Code

RT4501AWSC

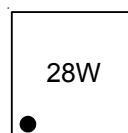

28 : Product Code
W : Date Code

Functional Pin Description

Pin No.	Pin Name	Pin Function
A1	LX	Switch Node of Boost Converter. Connect an inductor between LX and VIN.
A2	GND	Ground.
B1	VOUT	Power Output of the Asynchronous Boost Converter for Backlight LEDs. Connect a 1μF or larger ceramic capacitor from VOUT to ground.
B2	VIN	Power Input. Connect this pin to the input power supply voltage. Connect a 10μF or larger ceramic capacitor from the VIN to ground.
C1	PWM	PWM Dimming Input for Backlight LED.
C2	EN	Enable Control Input (Active High). The chip is in shutdown mode when the EN pin is low.
D1	SDA	I ² C Serial Data Input/Output. An external pull-up resistor is required.
D2	SCL	I ² C Serial Clock Input. An external pull-up resistor is required.
E1	FB2	Single Output 2 for Backlight LED.
E2	FB1	Single Output 1 for Backlight LED.

Function Block Diagram

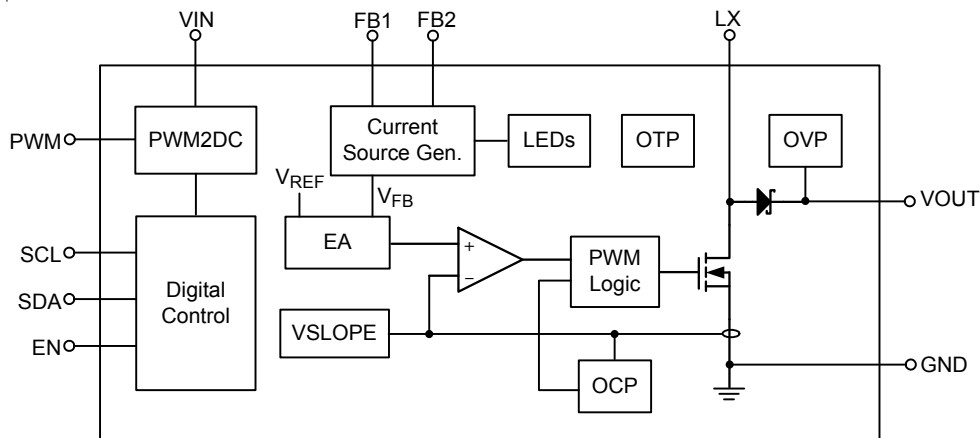

Operation Description

The RT4501/A is a high efficiency solution with 14 WLEDs in 2 parallels 7 series for backlight applications. The RT4501/A optimizes the feedback regulation voltage to provide up to 85% high efficiency with as high as 8bits resolution application.

Linear Brightness Dimming

The RT4501/A is built-in a I²C 8-bit resolution brightness control with maximum 20mA/30mA selection. Reg0x02<3> corresponds to full-scale LED current control. Reg0x04 sets 8bits resolution brightness dimming.

PWM Brightness Dimming

Besides programmable built-in I²C backlight LED current control, the RT4501 features a built-in PWM dimming current control by setting Reg0x02<6> to 1, offering a linear current dimming by external clock source. In order to guarantee the PWM dimming resolution, recommending dimming frequency have to be operated at range of 400Hz to 20kHz.

Pulse Brightness Dimming

The EN pin features a simple digital interface to allow digital brightness control. Using the one-wire dimming brightness control can achieve as high as 128 steps resolution, recommending dimming pulse is larger than 0.2μs. RT4501/A keeps shunt down status, when EN pin is pulled low keeping 1ms.

OCP Protection

The RT4501/A features a 1A current limitation. Once detecting current level over current limitation, the RT4501/A's LX witching will be forced off to avoid large current damage.

OTP Protection

The over-temperature protection function will be latched at shutdown status when the junction temperature exceeds 150°C for 2ms. After re-power on sequence, the converter will automatically resume switching.

OVP Protection

The over-voltage protection function monitors the output voltage via the VOUT pin voltage. The OVP threshold voltage is 25.5V/16V by selection Reg0x02<7>, Once the LED is open, the output voltage will be limited at OVP protection level to avoid device breakdown. RT4501 is shunt-down latched, by triggering OVP event over 40 times.

Absolute Maximum Ratings (Note 1)

- Supply Input Voltage, V_{IN} ----- -0.3V to 6V
- Boost Output Voltage, V_{OUT} ----- -0.3V to 27V
- Switching Voltage, LX ----- -0.3V to 27V
- Current Source Voltage, FB1, FB2 ----- -0.3V to 27V
- Other Pins, EN, PWM, SCL, SDA ----- -0.3V to 6V
- Power Dissipation, P_D @ $T_A = 25^\circ\text{C}$
 WL-CSP-10B 0.87x2.07 (BSC) ----- 1W
- Package Thermal Resistance (Note 2)
 WL-CSP-10B 0.87x2.07 (BSC), θ_{JA} ----- 99.6°C/W
- Lead Temperature (Soldering, 10 sec.) ----- 260°C
- Junction Temperature ----- 150°C
- Storage Temperature Range ----- -65°C to 150°C
- ESD Susceptibility (Note 3)
 HBM (Human Body Model) ----- 2kV
 MM (Machine Model) ----- 200V

Recommended Operating Conditions (Note 4)

- Supply Input Voltage, V_{IN} ----- 2.5V to 5.5V
- Junction Temperature Range ----- -40°C to 125°C
- Ambient Temperature Range ----- -40°C to 85°C

Electrical Characteristics

($V_{IN} = 3.6\text{V}$, $C_{IN} = 10\mu\text{F}$, $C_{OUT} = 1\mu\text{F}$, $L = 10\mu\text{H}$, $T_A = 25^\circ\text{C}$, unless otherwise specified)

Parameter	Symbol	Test Conditions	Min	Typ	Max	Unit
Input Power Supply						
Input Supply Voltage	V_{IN}		2.5	--	5.5	V
V_{IN} Quiescent Current	I_Q	PWM, No Switching	--	0.6	--	mA
Shutdown Current	I_{SHDN}	$V_{IN} = 4.2\text{V}$, EN = GND	--	1	3	μA
Under-Voltage Lockout Threshold	V_{UVLO}	V_{IN} Falling, Check $I_Q < 200\mu\text{A}$	--	--	2.3	V
Under-Voltage Lockout Hysteresis	ΔV_{UVLO}	After UVLO, V_{IN} Rising, Until $I_Q > 200\mu\text{A}$	--	200	--	mV
Backlight LED Current Source						
Accuracy of Output Current	I_{LED_ACC}	FB1, FB2 = 0.15V, $I_{FB1} = I_{FB2} = 20\text{mA}$	-5	--	5	%
Matching of Output Current	I_{LED_MAT}	FB1, FB2 = 0.15V, $I_{FB1} = I_{FB2} = 20\text{mA}$	-3	--	3	%
Oscillator and Timing						
Operating Frequency	f_{SW}	Reg0x03 [6] = 1	0.88	1.1	1.32	MHz
Maximum Duty Cycle	D_{MAX}	FB1 = FB2 = 0V, check MAX duty	90	95	--	%
Brightness Ramp Rate	T_{RAMP}	Reg0x03 [5:0] = 111111	209.72	262.14	314.58	ms

Parameter	Symbol	Test Conditions	Min	Typ	Max	Unit
Power Switch						
N-MOSFET On-Resistance	R _{DS(ON)_N}	V _{IN} = 3.6V	90	175	350	mΩ
N-MOSFET Current Limit	I _{OC}		0.8	1	1.2	A
N-MOSFET Leakage Current	I _{LEAK}	LX = 24V, No Switching	--	--	1	μA
Protection Function						
Over Voltage Protection	OVP	Reg0x02 [7] = 0	14	16	18	V
		Reg0x02 [7] = 1	24.5	25.5	26.5	V
Thermal Shutdown Threshold	T _{SD}	Thermal latch	--	150	--	°C
Logic Control						
EN Input Voltage	Logic-High	V _{ENH}	1.3	--	--	V
	Logic-Low	V _{ENL}	--	--	0.4	
PWM Input Voltage	Logic-High	V _{PWML}	1.3	--	--	V
	Logic-Low	V _{PWML}	--	--	0.4	
SCL Input Voltage	Logic-High	V _{SCLH}	1.3	--	--	V
	Logic-Low	V _{SCLL}	--	--	0.4	
SDA Input Voltage	Logic-High	V _{SDAH}	1.3	--	--	V
	Logic-Low	V _{SDAL}	--	--	0.4	
EN Pull-Down Resistance			--	400	--	kΩ
PWM Pull-Down Resistance			--	400	--	kΩ
Clock Frequency of SCL	f _{SCL}		--	--	400	kHz
Pulse Dimming Control						
EN Minimum Shut Down Pulse Width	t _{OFF}		1	--	--	ms
EN Minimum Logic High Pulse Width	t _{High_Min}		0.2	--	--	μs
EN Minimum Logic Low Pulse Width	t _{Low}		0.2	--	500	μs

Note 1. Stresses beyond those listed “Absolute Maximum Ratings” may cause permanent damage to the device. These are stress ratings only, and functional operation of the device at these or any other conditions beyond those indicated in the operational sections of the specifications is not implied. Exposure to absolute maximum rating conditions may affect device reliability.

Note 2. θ_{JA} is measured at T_A = 25°C on a high effective thermal conductivity four-layer test board per JEDEC 51-7.

Note 3. Devices are ESD sensitive. Handling precaution is recommended.

Note 4. The device is not guaranteed to function outside its operating conditions.

Typical Application Circuit

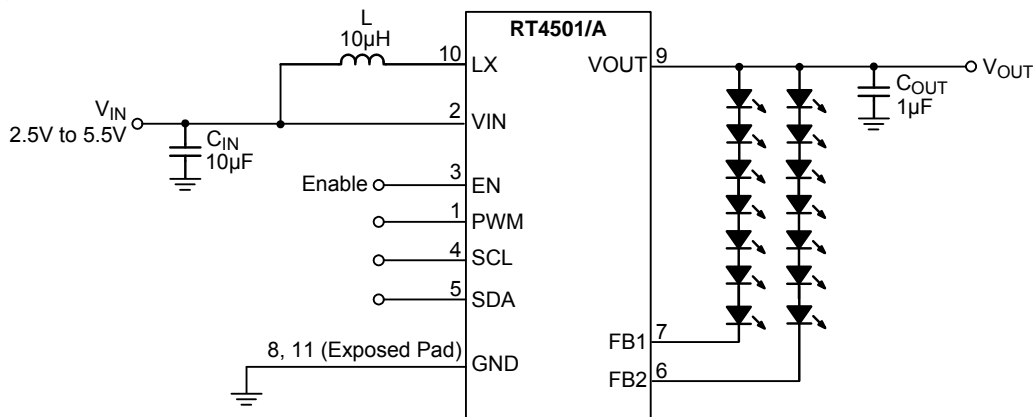

Timing Diagram

PWM Dimming

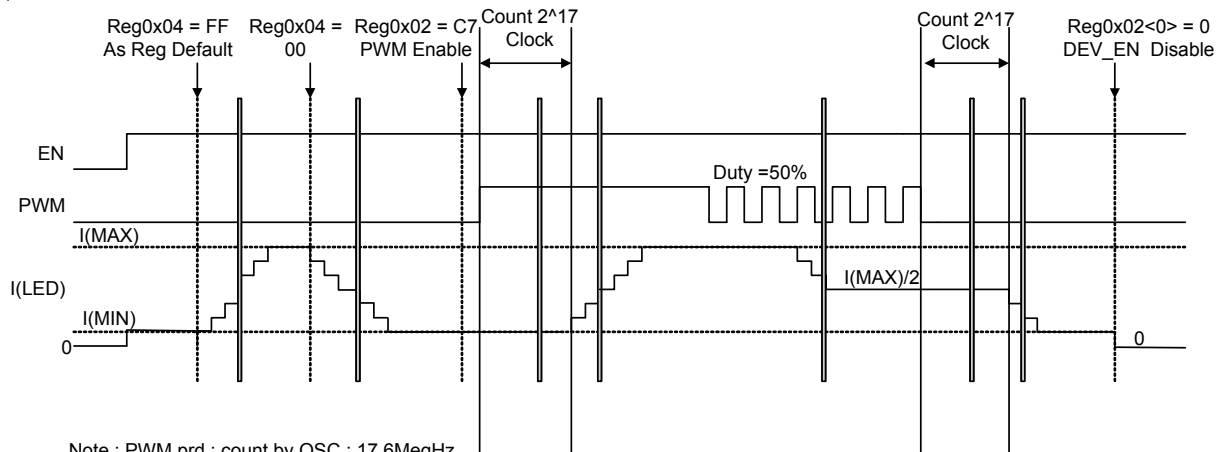

Note : PWM prd : count by OSC : 17.6MegHz
 > 1024 : Resolution = 7bits & < 1000 : Resolution = 8bits

Pulse Dimming

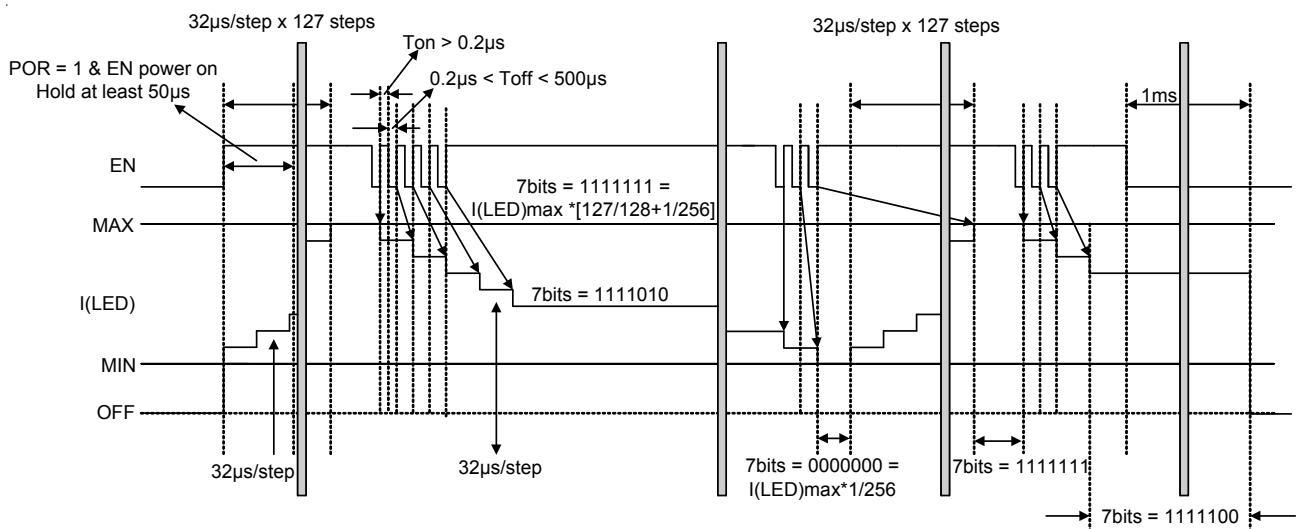

Protection Timing

OTP

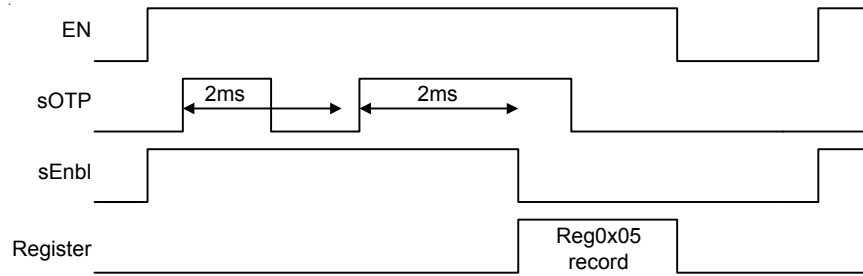

LED Short

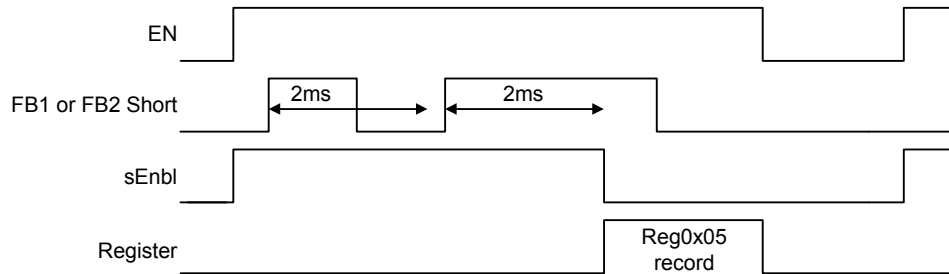

LED Open

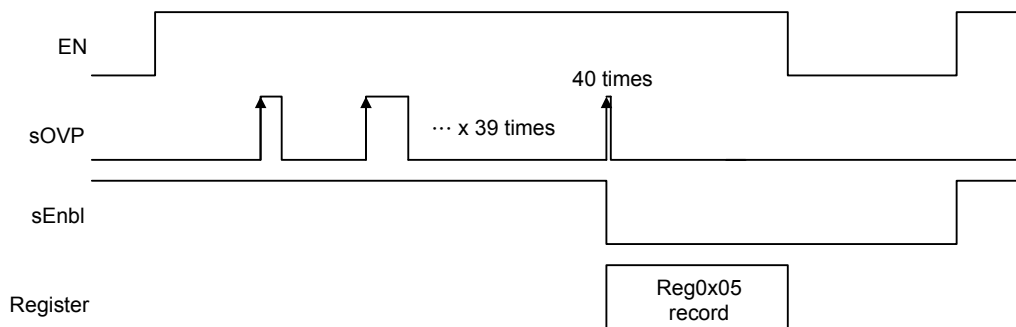

Typical Operating Characteristics

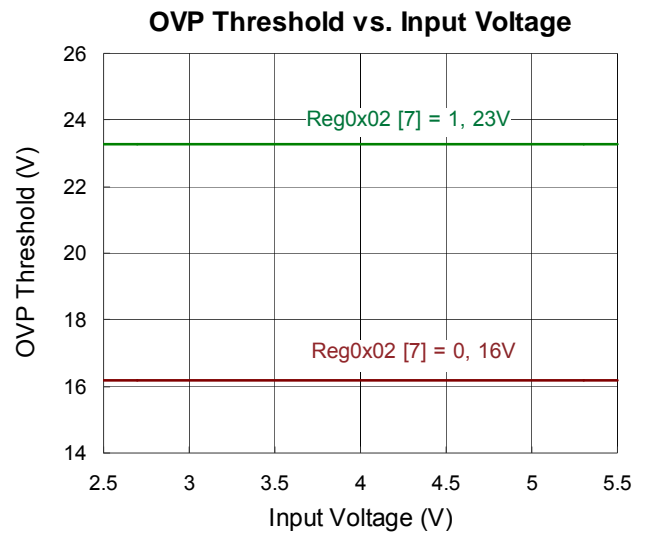
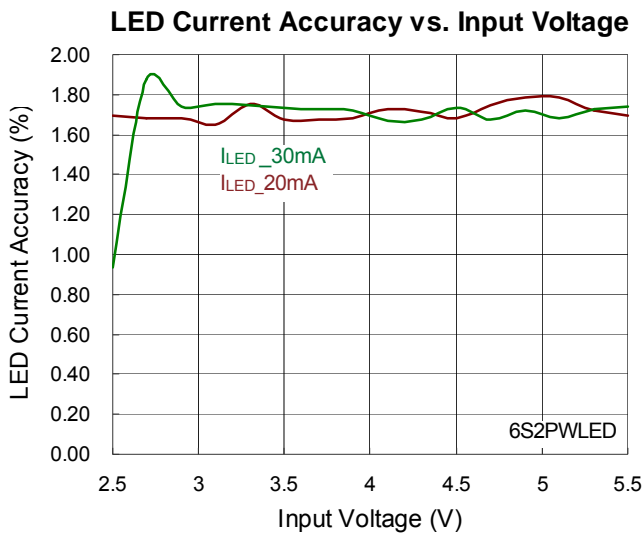
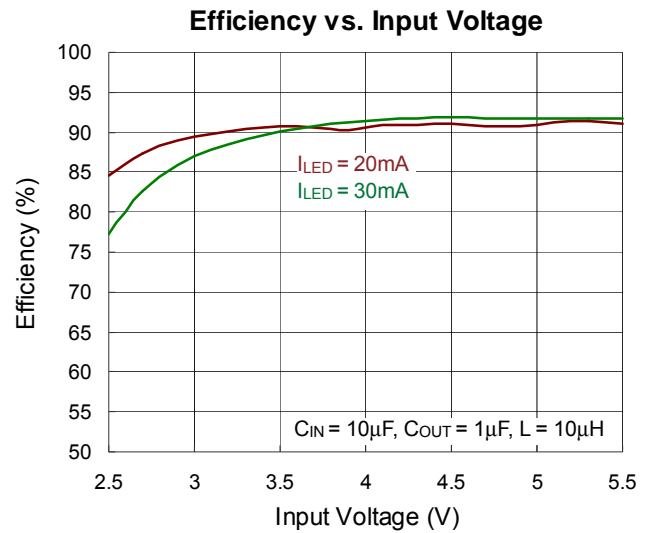
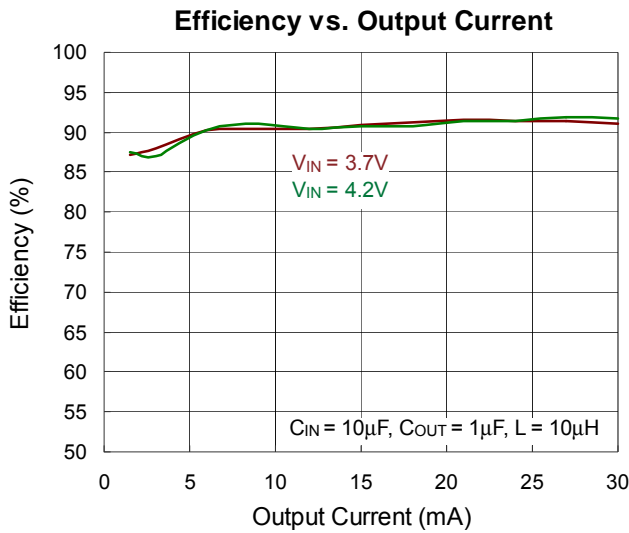
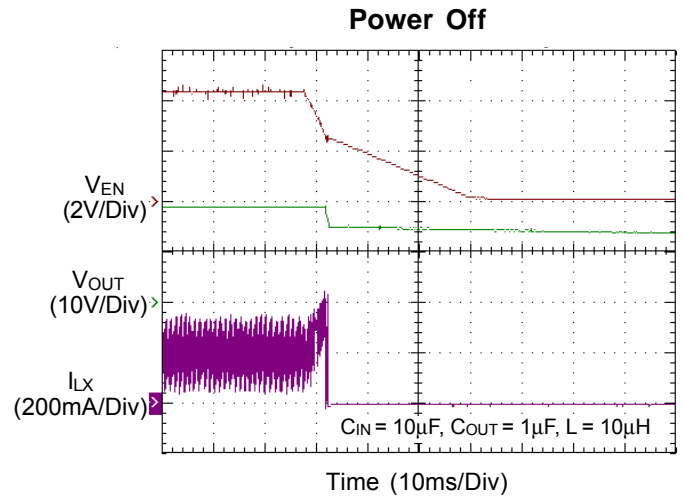
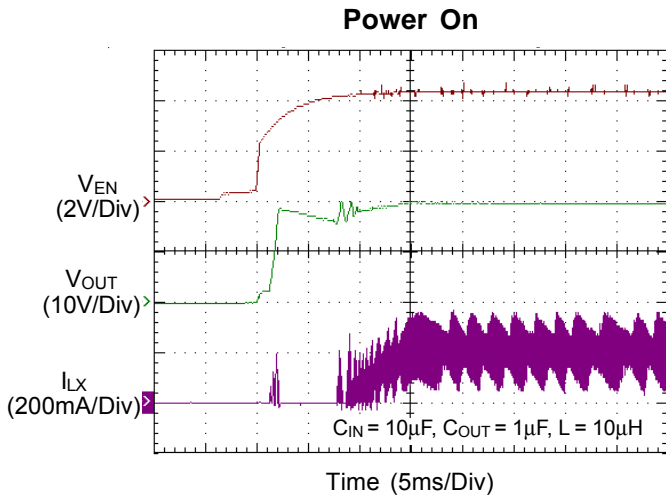

PWM Dimming Operation

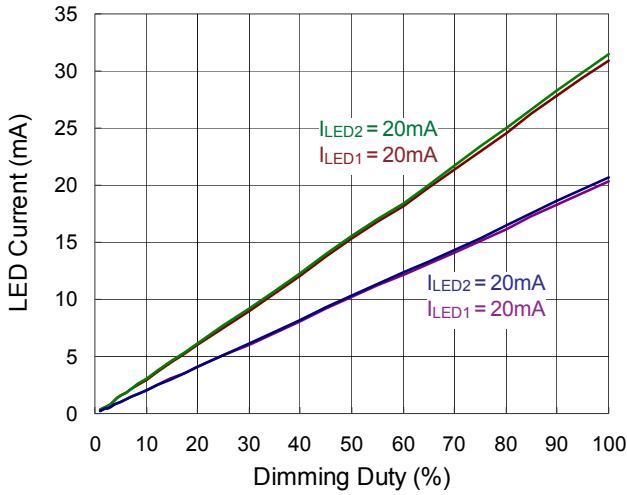

PWM Dimming

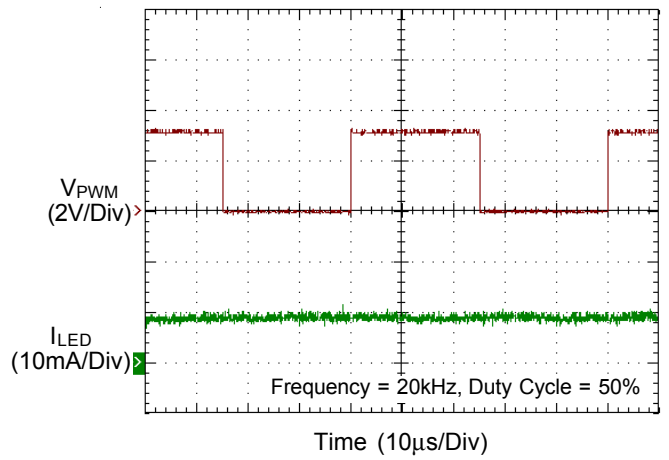

Switching Frequency vs. Input Voltage

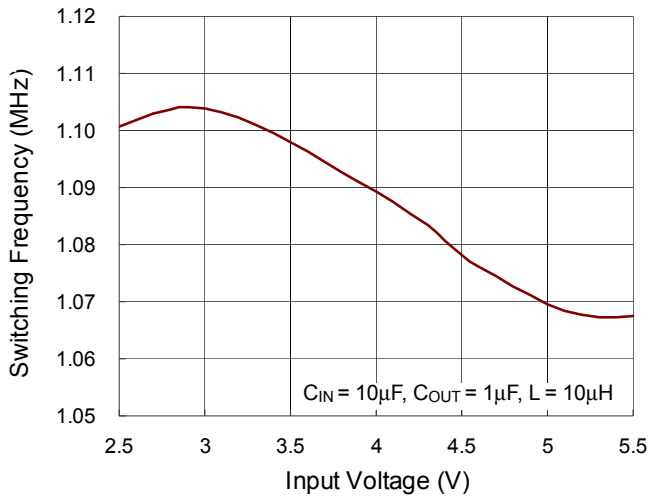

Quiescent Current vs. Input Voltage

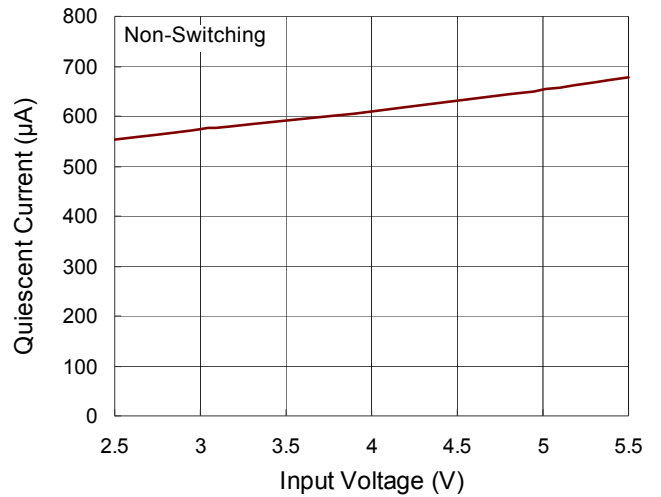

Shutdown Current vs. Input Voltage

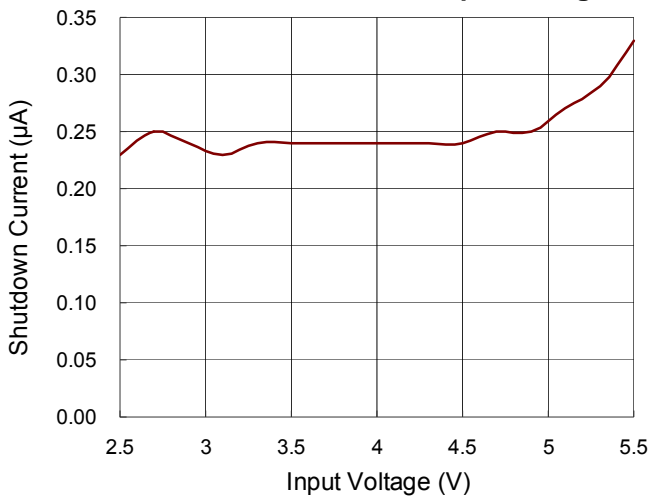

Enable Voltage vs. Input Voltage

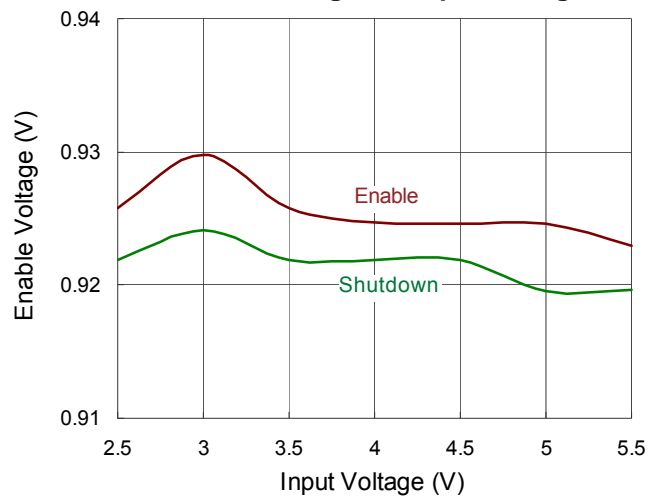

Table 1. Pulse Dimming Register Map

Slave address =0100010x

Address	Address Name	BIT	LABEL	Default (Reset Value)	Description
0x00	Device ID	7:0	DEV_ID		
0x01	Manufacture	7:2	REV	000000	Revision number
		1:0	VID	11	Vendor ID : Richtek
0x02	Config1	7	OVPsel	1	OVP threshold ([0] 16V, [1] 25.5V)
		6	Reserved		
		5	Reserved		
		4	Reserved		
		3	MAX_Current	0	[0] 20mA, [1] 30mA,
		2	LED1_EN	1	Backlight LED1 : [0] OFF, [1] ON
		1	LED2_EN	1	Backlight LED2 : [0] OFF, [1] ON
		0	DEV_EN	1	CHIP enable : [0] OFF, [1] ON
0x03	Timing	7	RST_SW	0	Software reset : [0] Disable(Auto), [1] Reset all registers
		6	FSW	1	Switching frequency ([0]550kHz, [1]1.1MHz)
		5:0	Reserved		
0x05	FLAG	7:4	Reserved	0	
		3	LED1_FT	0	LED1 short : [0] Normal, [1] Fault
		2	LED2_FT	0	LED2 short : [0] Normal, [1] Fault
		1	OVP	0	Output over voltage : [0] Normal, [1] Fault
		0	OTP	0	Over temperature : [0] Normal, [1] Fault

Table 2. PWM Dimming Register Map

Slave address =0100010x

Address	Address Name	BIT	LABEL	Default (Reset Value)	Description
0x00	Device ID	7:0	DEV_ID		
0x01	Manufacture	7:2	REV	000000	Revision number
		1:0	VID	11	Vendor ID : Richtek
0x02	Config1	7	OVPsel	1	OVP threshold ([0] 16V, [1] 25.5V)
		6	PWM_EN	0	PWM enable : [0] Ignored, [1] Enable
		5	PWM_SET	0	PWM active setup : [0] High active, [1] Low active
		4	Reserved		
		3	MAX_Current	0	[0] 20mA, [1] 30mA,
		2	LED1_EN	1	Backlight LED1 : [0] OFF, [1] ON
		1	LED2_EN	1	Backlight LED2 : [0] OFF, [1] ON
		0	DEV_EN	1	CHIP enable : [0] OFF, [1] ON
0x03	Timing	7	RST_SW	0	Software reset : [0] Disable(Auto), [1] Reset all registers
		6	FSW	1	Switching frequency ([0]550kHz, [1]1.1MHz)
		5:3	UP_RATE	000	Brightness ramp-up rate : [000] 32μs, [001] 4.096ms, [010] 8.192ms, [011] 16.383ms, [100] 32.768ms, [101] 65.536ms, [110] 131.072ms, [111] 262.144ms
		2:0	DN_RATE	000	Brightness ramp-down rate : [000] 32μs, [001] 4.096ms, [010] 8.192ms, [011] 16.383ms, [100] 32.768ms, [101] 65.536ms, [110] 131.072ms, [111] 262.144ms
0x04	Linear Brightness Control	7:0	BRIGHT_LIN	11111111	[00000000] 0.39%, [00000001] 0.39%, [11111111] 100%
0x05	FLAG	7:4	Reserved	0	
		3	LED1_FT	0	LED1 short : [0] Normal, [1] Fault
		2	LED2_FT	0	LED2 short : [0] Normal, [1] Fault
		1	OVP	0	Output over voltage : [0] Normal, [1] Fault
		0	OTP	0	Over temperature : [0] Normal, [1] Fault

Application Information

LED Short Protection

LED short protection prevents abnormal connection to cause IC damage avoiding FB1/FB2 connecting power supply. And, If unbalanced LEDs series (cause FB1 or FB2 >12V) is different between channel1 and channel2, IC will also occur LED short event. As LED short event occur more than deglitch time 2ms, IC will shut-down latch until IC is reset by EN pin.

Soft-Start

The RT4501/A includes a soft-start function to avoid high inrush current during start-up. The soft-start function is achieved by clamping the output voltage of the error amplifier with another voltage source that is increased slowly from zero to near VIN during the soft-start period.

OCP Protection

The RT4501/A features a 1A current limitation. The current flowing through the inductor during a charging period is detected by a current sensing circuit. If the value exceeds the current limit, the N-MOSFET will be turned off. The inductor will then be forced to leave charging stage and enter discharging stage. Therefore, the inductor current will not increase to reach current limit.

The over-temperature protection function will be latched at shutdown status when the junction temperature exceeds 165°C for 2ms. After re-power on sequence, the converter will automatically resume switching.

OVP Protection

The chip provides over-voltage protection function to limit the output voltage in abnormal conditions. The OVP threshold voltage is 25.5V/16V by selecting Reg0x02 <7>. Once the LED is open, the output voltage will be limited at OVP protection level to avoid device breakdown.

Under-Voltage Lockout

An under-voltage lockout circuit prevents the operation of the device at input voltages below under-voltage threshold (2.3V maximum). When the input voltage is below the

threshold, the device is shut down. If the input voltage rises over under-voltage lockout hysteresis (200mV typical), the IC restarts.

Linear Brightness Dimming

The chip is built-in an I²C 8-bit resolution brightness control with maximum 20mA/30mA selection. Reg0x02 <3> corresponds to full-scale LED current control. Reg0x04 <7:0> sets 8bits resolution brightness dimming control.

$$I_{LED} = \frac{\text{Code}}{255} \times I_{LED, Full}$$

Where

$I_{LED, Full}$: the full-scale LED current set by Reg0x02 <3>.

Code : the 8bit brightness code Reg0x04 <7:0> programmed by I²C interface.

PWM Brightness Dimming

Besides programmable built-in I²C backlight LED current control, the RT4501/A features a built-in PWM dimming current control by setting Reg0x02 <6> to 1, offering a linear current dimming by external clock source. In order to guarantee the PWM dimming resolution (7 bit at > 15kHz application), recommending dimming frequency have to be operated at range of 400Hz to 20kHz.

Pulse Brightness Dimming

The EN pin features a simple digital interface to allow digital brightness control. Using the one-wire dimming brightness control can achieve as high as 128 steps resolution, recommending dimming pulse is larger than 0.2μs. RT4501/A keeps shunt down status, when EN pin is pulled low keeping 1ms.

$$I_{LED} = \left(\frac{\text{Code}}{128} + \frac{1}{256} \right) \times I_{LED, Full}$$

Where

$I_{LED, Full}$: the full-scale LED current set by Reg0x02 <3>.

Inductor Selection

The recommended inductor value for dual-channel 6 WLEDs applications is 10μH. When selecting the inductor, the inductor rated saturation current should be higher than the peak current at maximum load. Small size and better efficiency are major concerns for portable devices. The inductor should have low core loss at 1.1MHz and low DCR for better efficiency.

Capacitor Selection

10μF input ceramic capacitor and 1μF output ceramic capacitor are recommended for driving dual-channel 6 WLEDs applications. For better voltage filtering, ceramic capacitors with low ESR are recommended. X5R and X7R types are suitable because of their wide voltage and temperature ranges.

Thermal Considerations

For continuous operation, do not exceed absolute maximum junction temperature. The maximum power dissipation depends on the thermal resistance of the IC package, PCB layout, rate of surrounding airflow, and difference between junction and ambient temperature. The maximum power dissipation can be calculated by the following formula :

$$P_{D(MAX)} = (T_{J(MAX)} - T_A) / \theta_{JA}$$

where $T_{J(MAX)}$ is the maximum junction temperature, T_A is the ambient temperature, and θ_{JA} is the junction to ambient thermal resistance.

For recommended operating condition specifications, the maximum junction temperature is 125°C. The junction to ambient thermal resistance, θ_{JA} , is layout dependent. For WL-CSP-10B 0.87x2.07 (BSC) package, the thermal resistance, θ_{JA} , is 99.6°C/W on a standard JEDEC 51-7 four-layer thermal test board. The maximum power dissipation at $T_A = 25^\circ\text{C}$ can be calculated by the following formula :

$$P_{D(MAX)} = (125^\circ\text{C} - 25^\circ\text{C}) / (99.6^\circ\text{C/W}) = 1\text{W for WL-CSP-10B 0.87x2.07 (BSC) package}$$

The maximum power dissipation depends on the operating ambient temperature for fixed $T_{J(MAX)}$ and thermal

resistance, θ_{JA} . The derating curve in Figure 1 allows the designer to see the effect of rising ambient temperature on the maximum power dissipation.

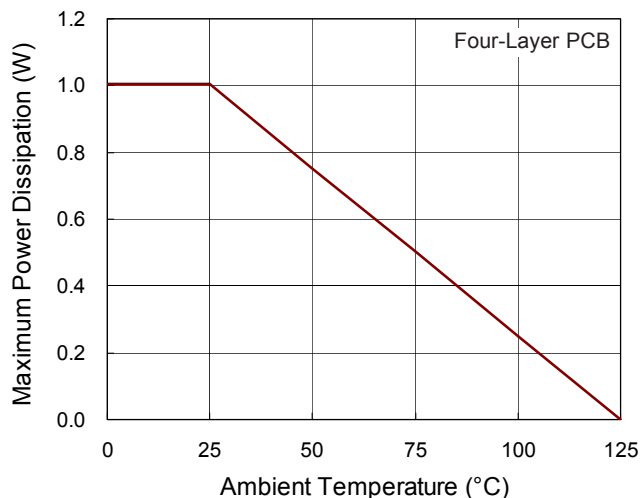
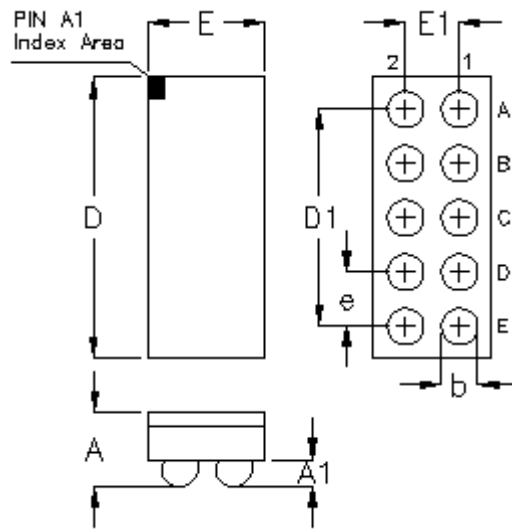

Figure 1. Derating Curve of Maximum Power Dissipation

Layout Consideration

As for all switching power supplies, the layout is an important step in the design, especially at high peak currents and switching frequencies. If the layout is not carefully done, the regulator might expose noise problems and duty cycle jitter. Therefore, use wide and short traces for high current paths. The input capacitor should be placed as close as possible to the input pin for good input voltage filtering. The inductor should be placed as close as possible to the switch pin to minimize the noise coupling into other circuits. The output capacitor needs to be placed directly from the VOUT pin to GND rather than across the LEDs. This reduces the ripple current in the trace to the LEDs. When doing the PCB layout, the bold traces should be routed first, as well as placement of the inductor, and input and output capacitors.

Outline Dimension



Symbol	Dimensions In Millimeters		Dimensions In Inches	
	Min.	Max.	Min.	Max.
A	0.500	0.600	0.020	0.024
A1	0.170	0.230	0.007	0.009
b	0.240	0.300	0.009	0.012
D	2.020	2.120	0.080	0.083
D1	1.600		0.063	
E	0.820	0.920	0.032	0.036
E1	0.400		0.016	
e	0.400		0.016	

10B WL-CSP 0.87x2.07 Package (BSC)

Richtek Technology Corporation

14F, No. 8, Tai Yuen 1st Street, Chupei City
 Hsinchu, Taiwan, R.O.C.
 Tel: (8863)5526789

Richtek products are sold by description only. Richtek reserves the right to change the circuitry and/or specifications without notice at any time. Customers should obtain the latest relevant information and data sheets before placing orders and should verify that such information is current and complete. Richtek cannot assume responsibility for use of any circuitry other than circuitry entirely embodied in a Richtek product. Information furnished by Richtek is believed to be accurate and reliable. However, no responsibility is assumed by Richtek or its subsidiaries for its use; nor for any infringements of patents or other rights of third parties which may result from its use. No license is granted by implication or otherwise under any patent or patent rights of Richtek or its subsidiaries.