

## 1.5MHz, 1A, High Efficiency PWM Step-Down DC/DC Converter

### General Description

The RT8016 is a high-efficiency Pulse-Width-Modulated (PWM) step-down DC-DC converter. Capable of delivering 1A output current over a wide input voltage range from 2.5V to 5.5V, the RT8016 is ideally suited for portable electronic devices that are powered from 1-cell Li-ion battery or from other power sources such as cellular phones, PDAs and hand-held devices.

Two operating modes are available including : PWM/Low-Dropout autoswitch and shut-down modes, the Internal synchronous rectifier with low  $R_{DS(ON)}$  dramatically reduces conduction loss at PWM mode. No external Schottky diode is required in practical application.

The RT8016 enters Low-Dropout mode when normal PWM cannot provide regulated output voltage by continuously turning on the upper PMOS. The RT8016 enters shut-down mode and consumes less than 0.1uA when EN pin is pulled low. The RT8016 also offers a range of 1V to 3.3V with 0.1V per step or adjustable output voltage by two external resistor.

The switching ripple is easily smoothed-out by small package filtering elements due to a fixed operating frequency of 1.5MHz. This along with small WDFN-6L 2x2 package provides small PCB area application. Other features include soft start, lower internal reference voltage with 2% accuracy, over temperature protection, and over current protection.

### Pin Configurations

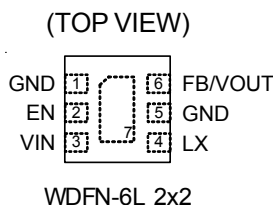

### Marking Information

For marking information, contact our sales representative directly or through a Richtek distributor located in your area.

### Features

- +2.5V to +5.5V Input Range
- Adjustable Output From 0.6V to  $V_{IN}$
- 1A Output Current
- 95% Efficiency
- No Schottky Diode Required
- 1.5MHz Fixed Frequency PWM Operation
- Small 6-Lead WDFN Package
- RoHS Compliant and 100% Lead (Pb)-Free

### Applications

- Mobile Phones
- Personal Information Appliances
- Wireless and DSL Modems
- MP3 Players
- Portable Instruments

### Ordering Information

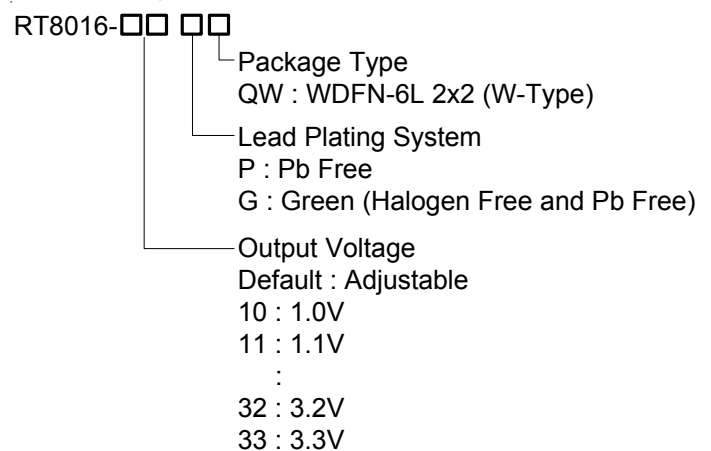

Note :

Richtek products are :

- ▶ RoHS compliant and compatible with the current requirements of IPC/JEDEC J-STD-020.
- ▶ Suitable for use in SnPb or Pb-free soldering processes.

## Typical Application Circuit

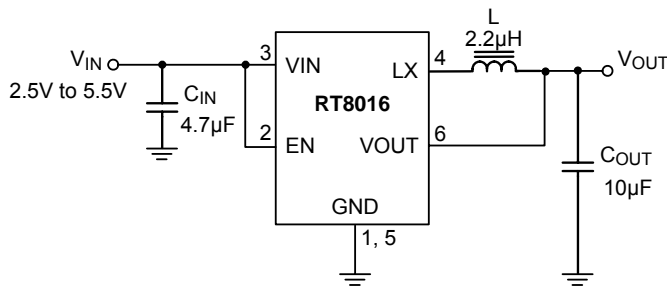
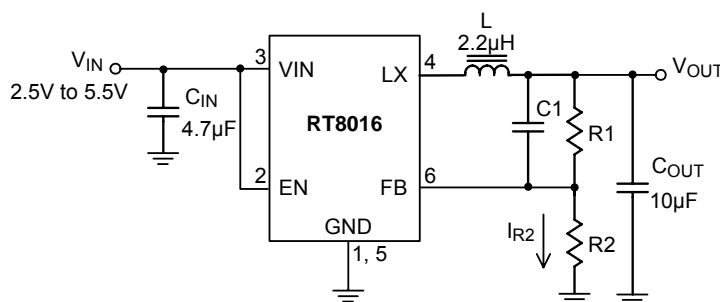

Figure 1. Fixed Voltage Regulator



$$V_{OUT} = V_{REF} \times \left(1 + \frac{R1}{R2}\right)$$

with  $R2 = 300k\Omega$  to  $60k\Omega$  so the  $I_{R2} = 2\mu A$  to  $10\mu A$ ,

and  $(R1 \times C1)$  should be in the range between  $3 \times 10^{-6}$  and  $6 \times 10^{-6}$  for component selection.

Figure 2. Adjustable Voltage Regulator

### Layout Guide

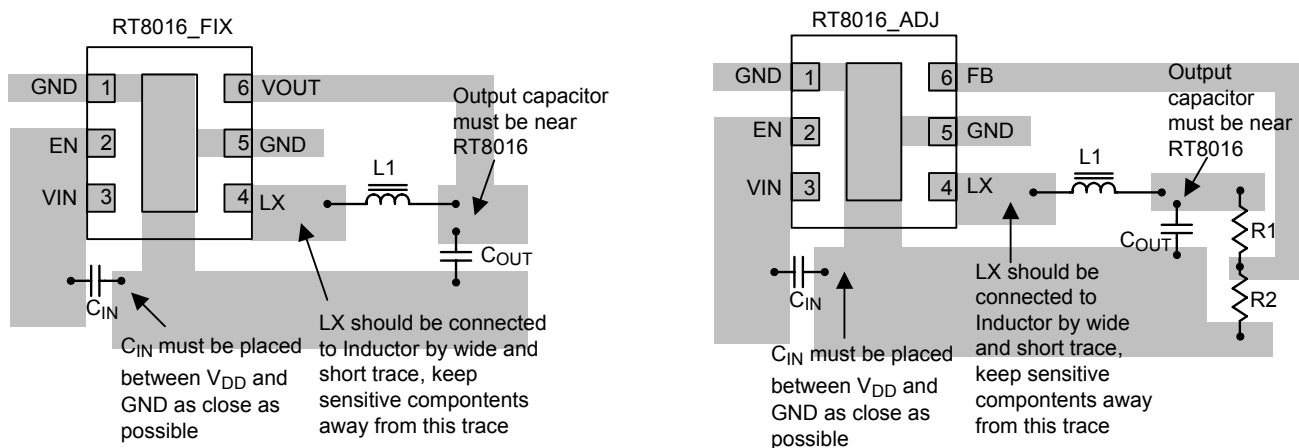

Layout note:

1. The distance that  $C_{IN}$  connects to  $V_{IN}$  is as close as possible (Under 2mm).
2.  $C_{OUT}$  should be placed near RT8016.

Figure 3. Layout Guide for RT8016

**Functional Pin Description**

| Pin No.         | Pin Name | Pin Function  |
|-----------------|----------|---|
| 2               | EN       | Chip Enable (Active High).  |
| 3               | VIN      | Power Input.  |
| 4               | LX       | Pin for Switching.  |
| 1, 5            | GND      | Ground Pin.   |
| 6               | FB/VOUT  | Feedback/Output Voltage Pin.  |
| 7 (Exposed Pad) | NC       | No Internal Connection. The exposed pad must be soldered to a large PCB and connected to GND for maximum power dissipation. |

**Function Block Diagram**

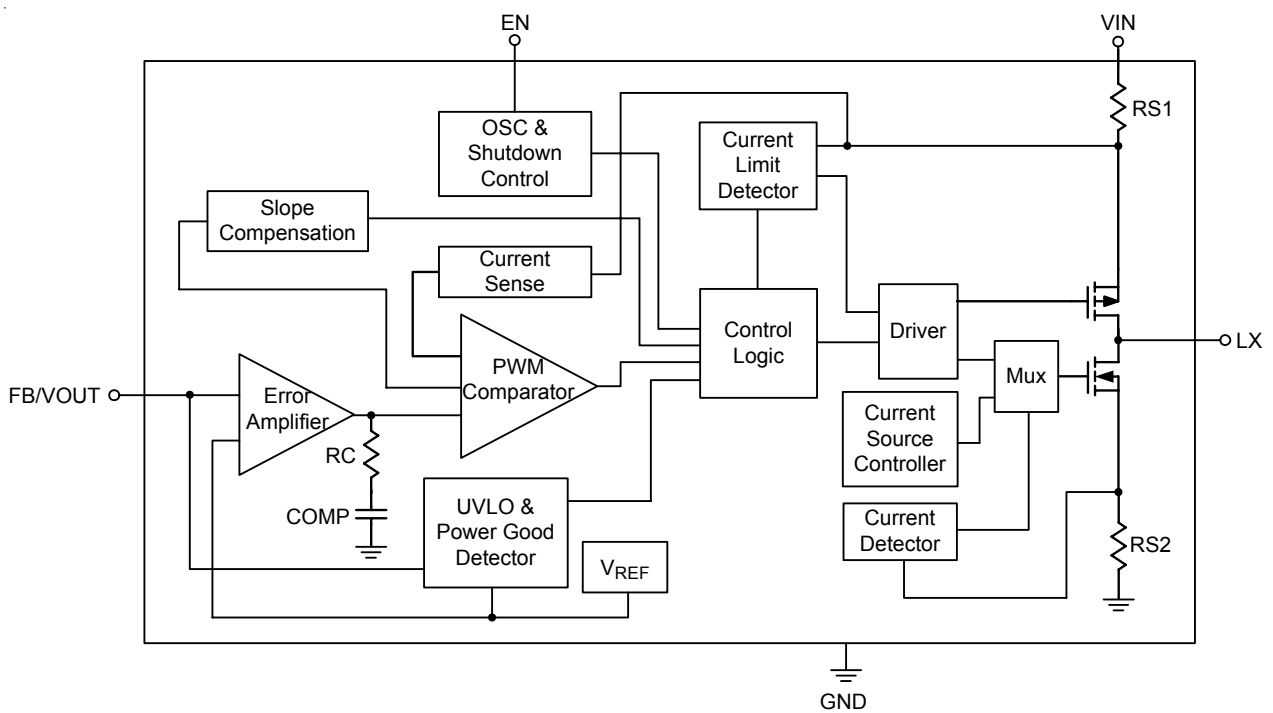

## Absolute Maximum Ratings (Note 1)

|   |                   |
|---|-------------------|
| • Supply Input Voltage                                | 6.5V              |
| • EN, FB Pin Voltage                                  | -0.3V to $V_{IN}$ |
| • Power Dissipation, $P_D$ @ $T_A = 25^\circ\text{C}$ |                   |
| WDFN-6L 2x2   | 0.606W            |
| • Package Thermal Resistance (Note 2)                 |                   |
| WDFN-6L 2x2, $\theta_{JA}$                            | 165°C/W           |
| WDFN-6L 2x2, $\theta_{JC}$                            | 20°C/W            |
| • Lead Temperature (Soldering, 10 sec.)               | 260°C             |
| • Storage Temperature Range                           | -65°C to 150°C    |
| • Junction Temperature                                | 150°C             |
| • ESD Susceptibility (Note 3)                         |                   |
| HBM (Human Body Mode)                                 | 2kV               |
| MM (Machine Mode)                                     | 200V              |

## Recommended Operating Conditions (Note 4)

|                              |                |
|------------------------------|----------------|
| • Supply Input Voltage       | 2.5V to 5.5V   |
| • Junction Temperature Range | -40°C to 125°C |
| • Ambient Temperature Range  | -40°C to 85°C  |

## Electrical Characteristics

( $V_{IN} = 3.6\text{V}$ ,  $V_{OUT} = 2.5\text{V}$ ,  $V_{REF} = 0.6\text{V}$ ,  $L = 2.2\mu\text{H}$ ,  $C_{IN} = 4.7\mu\text{F}$ ,  $C_{OUT} = 10\mu\text{F}$ ,  $T_A = 25^\circ\text{C}$ ,  $I_{MAX} = 1\text{A}$  unless otherwise specified)

| Parameter                   | Symbol         | Test Conditions  | Min                    | Typ   | Max                    | Unit          |          |
|-----------------------------|----------------|--|------------------------|-------|------------------------|---------------|----------|
| Input Voltage Range         | $V_{IN}$       |  | 2.5                    | --    | 5.5                    | V             |          |
| Quiescent Current           | $I_Q$          | $I_{OUT} = 0\text{mA}$ , $V_{FB} = V_{REF} + 5\%$  | --                     | 50    | 70                     | $\mu\text{A}$ |          |
| Shutdown Current            | $I_{SHDN}$     | EN = GND   | --                     | 0.1   | 1                      | $\mu\text{A}$ |          |
| Reference Voltage           | $V_{REF}$      | For Adjustable Output Voltage  | 0.588                  | 0.600 | 0.612                  | V             |          |
| Adjustable Output Range     | $V_{OUT}$      | (Note 6)   | $V_{REF}$              | --    | $V_{IN} - 0.2\text{V}$ | V             |          |
| Output Voltage Accuracy     | Fix            | $V_{IN} = (V_{OUT} + \Delta V)$ to 5.5V or $V_{IN} > 2.5\text{V}$ which ever is larger. (Note 5) | -3                     | --    | 3                      | %             |          |
|                             | Adjustable     | $V_{IN} = V_{OUT} + \Delta V$ to 5.5V (Note 5)<br>$0\text{A} < I_{OUT} < 1\text{A}$              | -3                     | --    | 3                      | %             |          |
| FB Input Current            | $I_{FB}$       | $V_{FB} = V_{IN}$  | -50                    | --    | 50                     | nA            |          |
| P-MOSFET $R_{ON}$           | $R_{DS(ON)_P}$ | $I_{OUT} = 200\text{mA}$   | $V_{IN} = 3.6\text{V}$ | --    | 0.28                   | --            | $\Omega$ |
|                             |                |  | $V_{IN} = 2.5\text{V}$ | --    | 0.38                   | --            |          |
| N-MOSFET $R_{ON}$           | $R_{DS(ON)_N}$ | $I_{OUT} = 200\text{mA}$   | $V_{IN} = 3.6\text{V}$ | --    | 0.25                   | --            | $\Omega$ |
|                             |                |  | $V_{IN} = 2.5\text{V}$ | --    | 0.35                   | --            |          |
| P-Channel Current Limit     | $I_{LIM\_P}$   | $V_{IN} = 2.5\text{V}$ to 5.5 V  | 1.4                    | 2     | 2.6                    | A             |          |
| EN High-Level Input Voltage | $V_{EN\_H}$    |  | 1.5                    | --    | $V_{IN}$               | V             |          |

| Parameter                        | Symbol            | Test Conditions  | Min | Typ | Max | Unit |
|----------------------------------|-------------------|--|-----|-----|-----|------|
| EN Low-Level Input Voltage       | V <sub>EN_L</sub> |  | --  | --  | 0.4 | V    |
| Under Voltage Lock Out threshold | UVLO              |  | --  | 1.8 | --  | V    |
| Hysteresis                       |                   |  | --  | 0.1 | --  | V    |
| Oscillator Frequency             | f <sub>OSC</sub>  | V <sub>IN</sub> = 3.6V, I <sub>OUT</sub> = 100mA                       | 1.2 | 1.5 | 1.8 | MHz  |
| Thermal Shutdown Temperature     | T <sub>SD</sub>   |  | --  | 160 | --  | °C   |
| Max. Duty Cycle                  |                   |  | 100 | --  | --  | %    |
| LX Current Source                |                   | V <sub>IN</sub> = 3.6V, V <sub>LX</sub> = 0V or V <sub>LX</sub> = 3.6V | 1   | --  | 100 | μA   |
| Minimum On-Time                  | t <sub>ON</sub>   |  | --  | 120 | 140 | ns   |

**Note 1.** Stresses beyond those listed “Absolute Maximum Ratings” may cause permanent damage to the device. These are stress ratings only, and functional operation of the device at these or any other conditions beyond those indicated in the operational sections of the specifications is not implied. Exposure to absolute maximum rating conditions may affect device reliability.

**Note 2.** θ<sub>JA</sub> is measured at T<sub>A</sub> = 25°C on a single-layer and four-layer test board of JEDEC 51. The measurement case position of θ<sub>JC</sub> is on the lead of the package.

**Note 3.** Devices are ESD sensitive. Handling precaution is recommended.

**Note 4.** The device is not guaranteed to function outside its operating conditions.

**Note 5.** ΔV = I<sub>OUT</sub> x P<sub>RDS(ON)</sub>

**Note 6.** Guarantee by design.

**Note 7.** The start up time is about 300μs.

Typical Operating Characteristics

Efficiency vs. Output Current

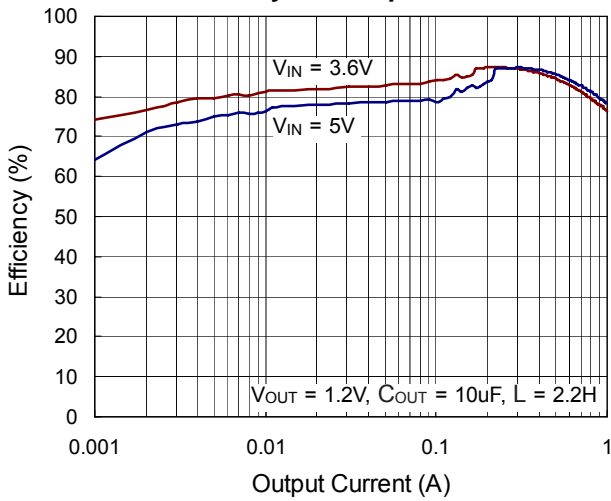

Output Voltage vs. Output Current

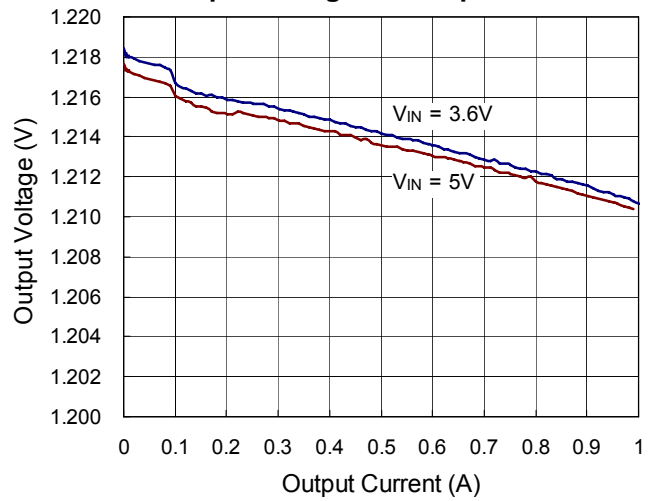

Output Voltage vs. Temperature

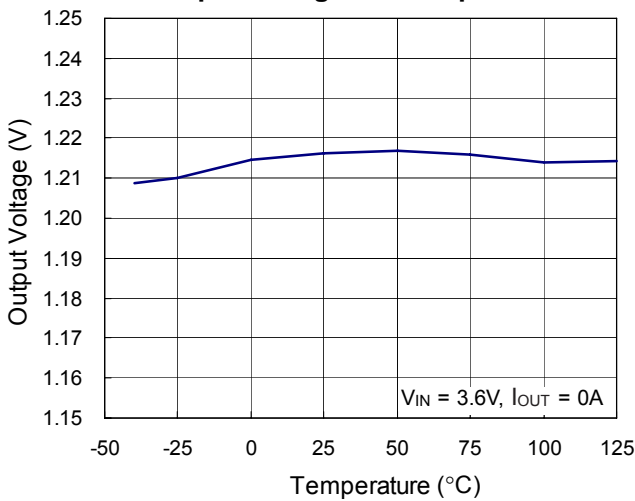

UVLO Threshold vs. Temperature

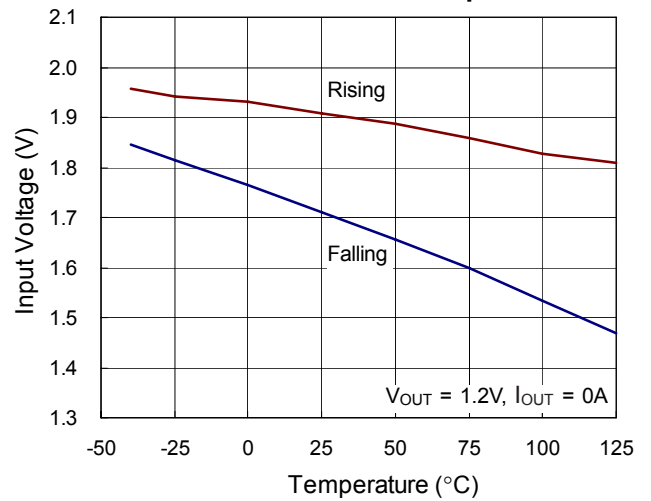

EN Threshold vs. Input Voltage

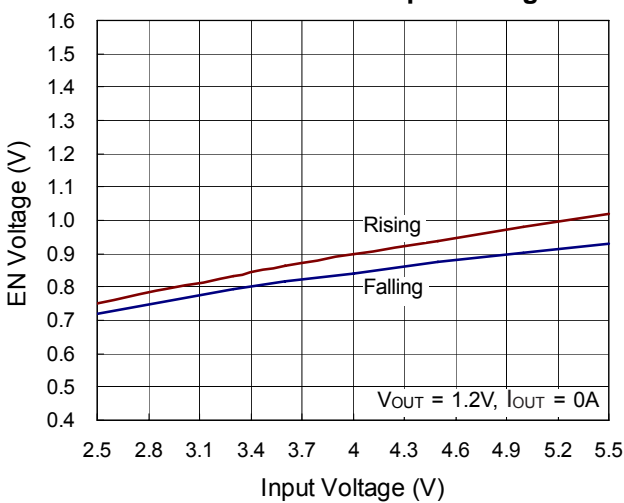

EN Threshold vs. Temperature

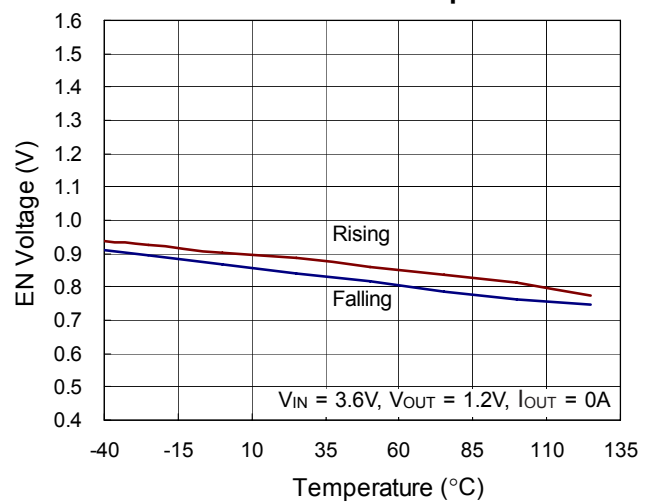

**Frequency vs. Input Voltage**

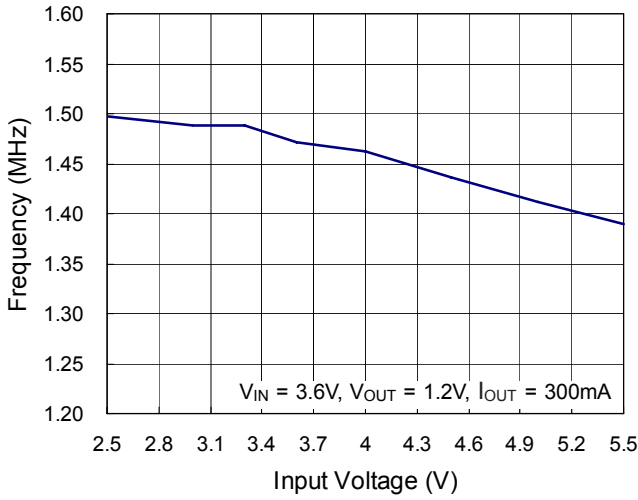

**Frequency vs. Temperature**

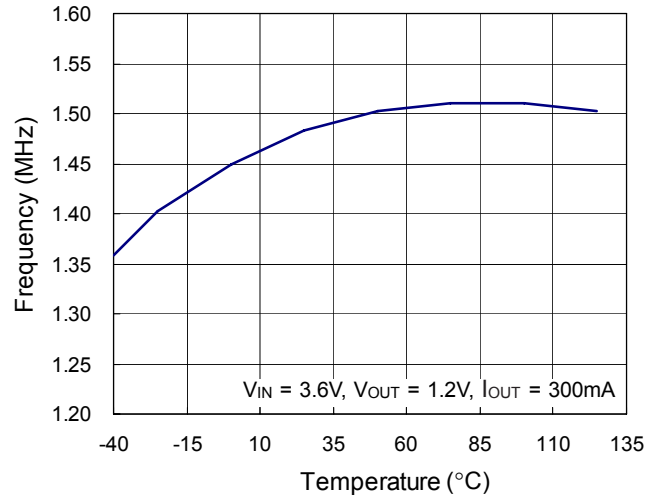

**Current Limit vs. Input Voltage**

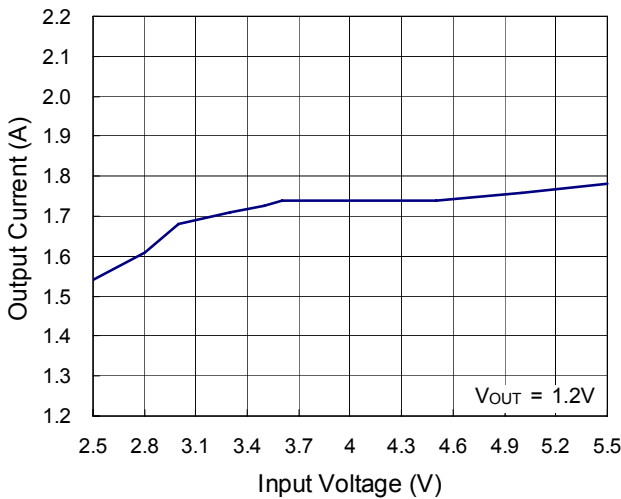

**Current Limit vs. Temperature**

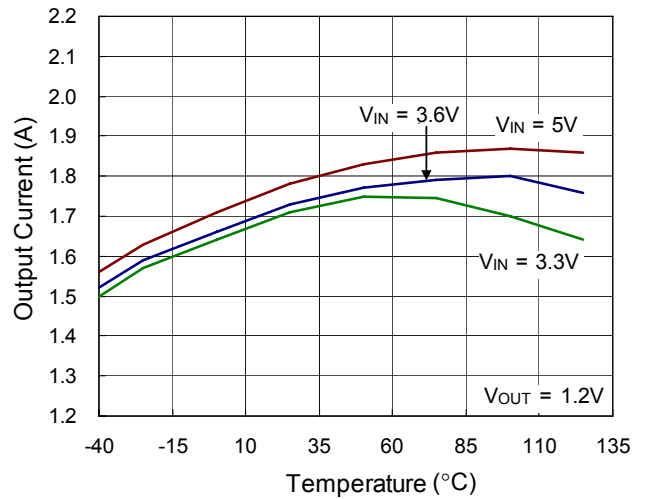

**Output Ripple Voltage**

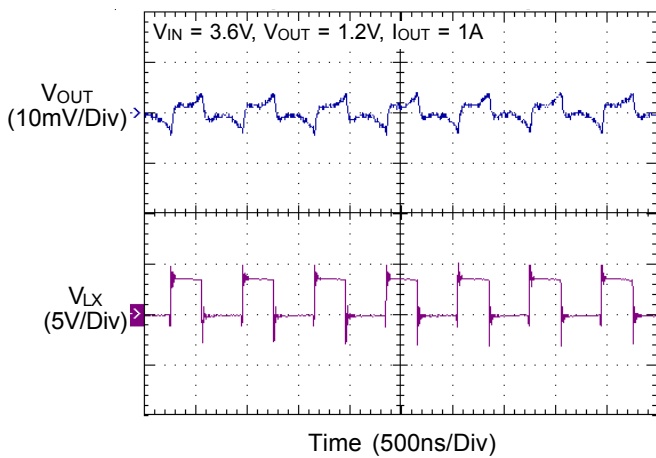

**Output Ripple Voltage**

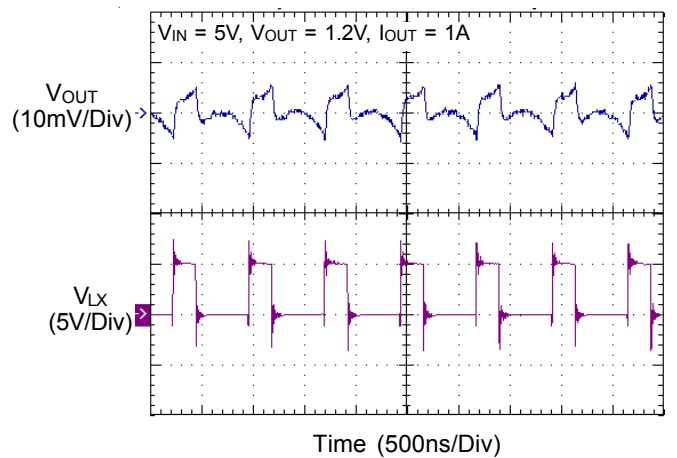

Power On from EN

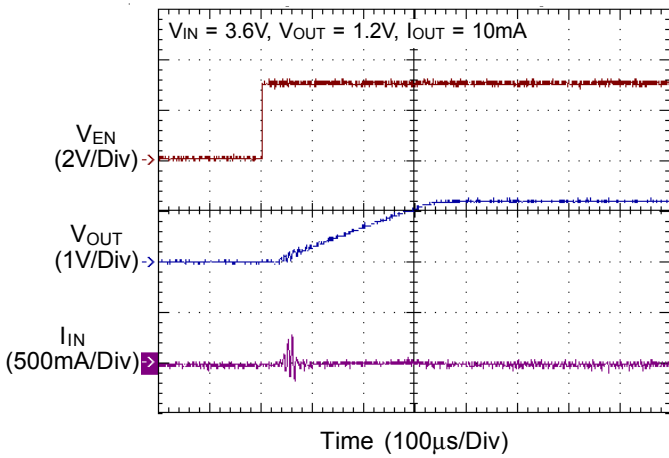

Power On from EN

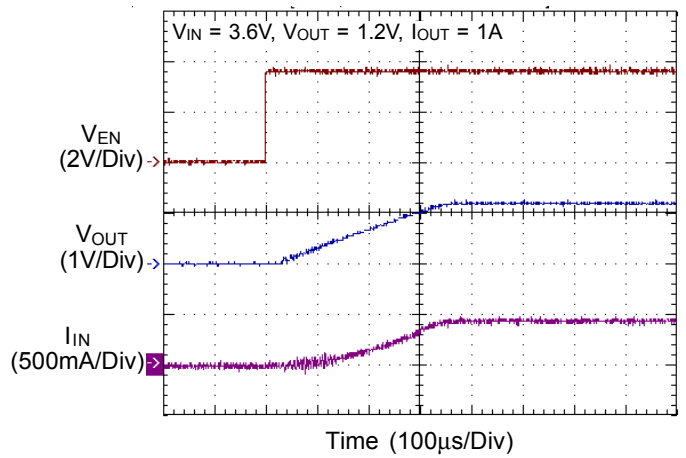

Power On from VIN

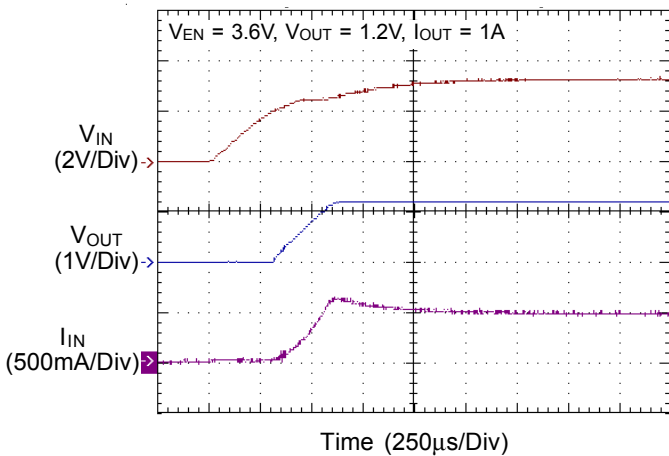

Power Off from EN

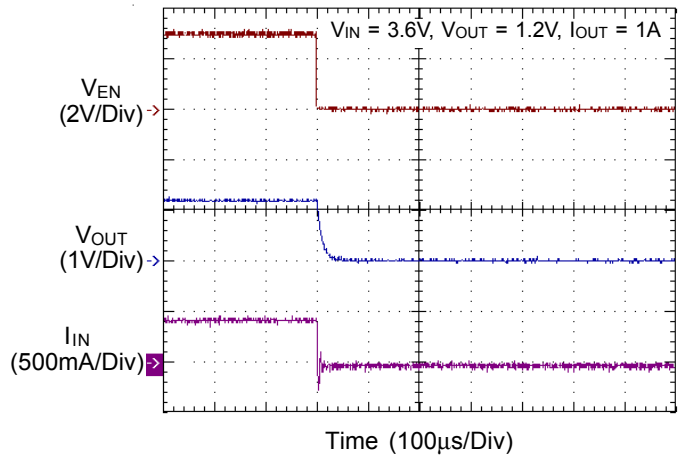

Load Transient Response

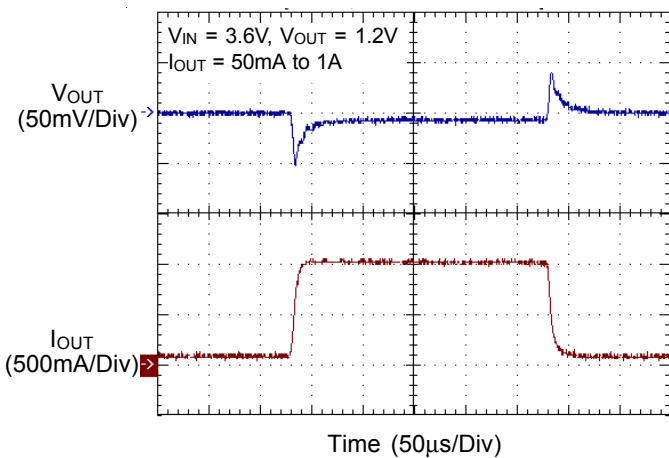

Load Transient Response

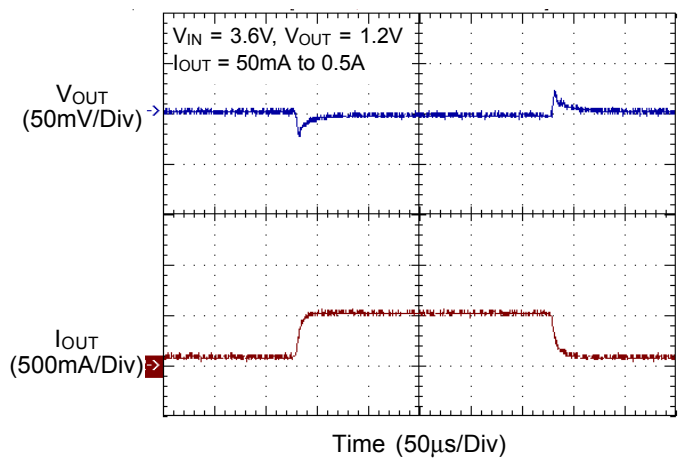



Load Transient Response

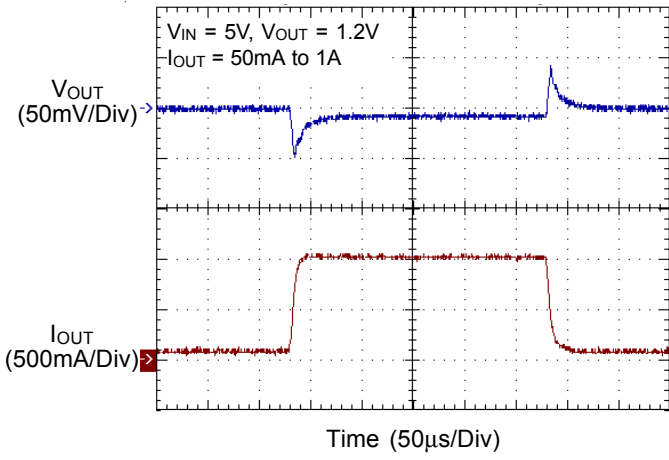

Load Transient Response

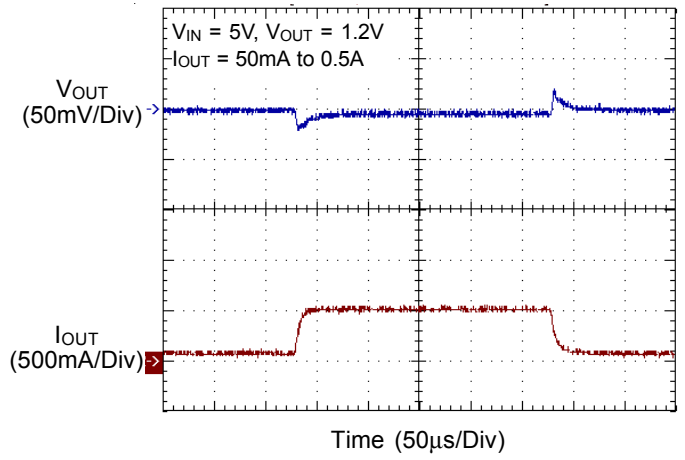

## Applications Information

The basic RT8016 application circuit is shown in Typical Application Circuit. External component selection is determined by the maximum load current and begins with the selection of the inductor value and operating frequency followed by  $C_{IN}$  and  $C_{OUT}$ .

### Inductor Selection

For a given input and output voltage, the inductor value and operating frequency determine the ripple current. The ripple current  $\Delta I_L$  increases with higher  $V_{IN}$  and decreases with higher inductance.

$$\Delta I_L = \left[ \frac{V_{OUT}}{f \times L} \right] \times \left[ 1 - \frac{V_{OUT}}{V_{IN}} \right]$$

Having a lower ripple current reduces the ESR losses in the output capacitors and the output voltage ripple. Highest efficiency operation is achieved at low frequency with small ripple current. This, however, requires a large inductor.

A reasonable starting point for selecting the ripple current is  $\Delta I_L = 0.4(I_{MAX})$ . The largest ripple current occurs at the highest  $V_{IN}$ . To guarantee that the ripple current stays below a specified maximum, the inductor value should be chosen according to the following equation :

$$L = \left[ \frac{V_{OUT}}{f \times \Delta I_L(MAX)} \right] \times \left[ 1 - \frac{V_{OUT}}{V_{IN(MAX)}} \right]$$

### Inductor Core Selection

Once the value for L is known, the type of inductor must be selected. High efficiency converters generally cannot afford the core loss found in low cost powdered iron cores, forcing the use of more expensive ferrite or mollypermalloy cores. Actual core loss is independent of core size for a fixed inductor value but it is very dependent on the inductance selected. As the inductance increases, core losses decrease. Unfortunately, increased inductance requires more turns of wire and therefore copper losses will increase.

Ferrite designs have very low core losses and are preferred at high switching frequencies, so design goals can concentrate on copper loss and preventing saturation. Ferrite core material saturates "hard", which means that

inductance collapses abruptly when the peak design current is exceeded. This results in an abrupt increase in inductor ripple current and consequent output voltage ripple. Do not allow the core to saturate!

Different core materials and shapes will change the size/current and price/current relationship of an inductor.

Toroid or shielded pot cores in ferrite or permalloy materials are small and don't radiate energy but generally cost more than powdered iron core inductors with similar characteristics. The choice of which style inductor to use mainly depends on the price vs size requirements and any radiated field/EMI requirements.

### $C_{IN}$ and $C_{OUT}$ Selection

The input capacitance,  $C_{IN}$ , is needed to filter the trapezoidal current at the source of the top MOSFET. To prevent large ripple voltage, a low ESR input capacitor sized for the maximum RMS current should be used. RMS current is given by :

$$I_{RMS} = I_{OUT(MAX)} \frac{V_{OUT}}{V_{IN}} \sqrt{\frac{V_{IN}}{V_{OUT}} - 1}$$

This formula has a maximum at  $V_{IN} = 2V_{OUT}$ , where  $I_{RMS} = I_{OUT}/2$ . This simple worst-case condition is commonly used for design because even significant deviations do not offer much relief. Note that ripple current ratings from capacitor manufacturers are often based on only 2000 hours of life which makes it advisable to further derate the capacitor, or choose a capacitor rated at a higher temperature than required. Several capacitors may also be paralleled to meet size or height requirements in the design.

The selection of  $C_{OUT}$  is determined by the effective series resistance (ESR) that is required to minimize voltage ripple and load step transients, as well as the amount of bulk capacitance that is necessary to ensure that the control loop is stable. Loop stability can be checked by viewing the load transient response as described in a later section.

The output ripple,  $\Delta V_{OUT}$ , is determined by :

$$\Delta V_{OUT} \leq \Delta I_L \left[ ESR + \frac{1}{8fC_{OUT}} \right]$$

The output ripple is highest at maximum input voltage since  $\Delta I_L$  increases with input voltage. Multiple capacitors placed in parallel may be needed to meet the ESR and RMS current handling requirements. Dry tantalum, special polymer, aluminum electrolytic and ceramic capacitors are all available in surface mount packages. Special polymer capacitors offer very low ESR but have lower capacitance density than other types. Tantalum capacitors have the highest capacitance density but it is important to only use types that have been surge tested for use in switching power supplies. Aluminum electrolytic capacitors have significantly higher ESR but can be used in cost-sensitive applications provided that consideration is given to ripple current ratings and long term reliability. Ceramic capacitors have excellent low ESR characteristics but can have a high voltage coefficient and audible piezoelectric effects. The high Q of ceramic capacitors with trace inductance can also lead to significant ringing.

**Using Ceramic Input and Output Capacitors**

Higher values, lower cost ceramic capacitors are now becoming available in smaller case sizes. Their high ripple current, high voltage rating and low ESR make them ideal for switching regulator applications. However, care must be taken when these capacitors are used at the input and output. When a ceramic capacitor is used at the input and the power is supplied by a wall adapter through long wires, a load step at the output can induce ringing at the input,  $V_{IN}$ . At best, this ringing can couple to the output and be mistaken as loop instability. At worst, a sudden inrush of current through the long wires can potentially cause a voltage spike at  $V_{IN}$  large enough to damage the part.

**Output Voltage Programming**

The resistive divider allows the FB pin to sense a fraction of the output voltage as shown in Figure 4.

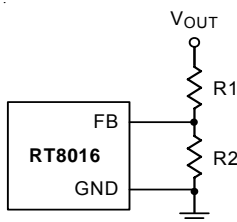

Figure 4. Setting the Output Voltage

For adjustable voltage mode, the output voltage is set by an external resistive divider according to the following equation :

$$V_{OUT} = V_{REF} \left( 1 + \frac{R1}{R2} \right)$$

where  $V_{REF}$  is the internal reference voltage (0.6V typ.)

**Efficiency Considerations**

The efficiency of a switching regulator is equal to the output power divided by the input power times 100%. It is often useful to analyze individual losses to determine what is limiting the efficiency and which change would produce the most improvement. Efficiency can be expressed as :

$$\text{Efficiency} = 100\% - (L1 + L2 + L3 + \dots)$$

where L1, L2, etc. are the individual losses as a percentage of input power. Although all dissipative elements in the circuit produce losses, two main sources usually account for most of the losses :  $V_{IN}$  quiescent current and  $I^2R$  losses.

The  $V_{IN}$  quiescent current loss dominates the efficiency loss at very low load currents whereas the  $I^2R$  loss dominates the efficiency loss at medium to high load currents. In a typical efficiency plot, the efficiency curve at very low load currents can be misleading since the actual power lost is of no consequence.

1. The  $V_{IN}$  quiescent current appears due to two factors including : the DC bias current as given in the electrical characteristics and the internal main switch and synchronous switch gate charge currents. The gate charge current results from switching the gate capacitance of the internal power MOSFET switches. Each time the gate is switched from high to low to high again, a packet of charge  $\Delta Q$  moves from  $V_{IN}$  to ground.

The resulting  $\Delta Q/\Delta t$  is the current out of  $V_{IN}$  that is typically larger than the DC bias current. In continuous mode,

$$I_{GATECHG} = f(Q_T + Q_B)$$

where  $Q_T$  and  $Q_B$  are the gate charges of the internal top and bottom switches. Both the DC bias and gate charge losses are proportional to  $V_{IN}$  and thus their effects will be more pronounced at higher supply voltages.

2.  $I^2R$  losses are calculated from the resistances of the internal switches,  $R_{SW}$  and external inductor  $R_L$ . In continuous mode, the average output current flowing through inductor L is “chopped” between the main switch and the synchronous switch. Thus, the series resistance looking into the LX pin is a function of both top and bottom MOSFET  $R_{DS(ON)}$  and the duty cycle (DC) as follows :

$$R_{SW} = R_{DS(ON)TOP} \times DC + R_{DS(ON)BOT} \times (1-DC)$$

The  $R_{DS(ON)}$  for both the top and bottom MOSFETs can be obtained from the Typical Performance Characteristics curves. Thus, to obtain  $I^2R$  losses, simply add  $R_{SW}$  to  $R_L$  and multiply the result by the square of the average output current.

Other losses including  $C_{IN}$  and  $C_{OUT}$  ESR dissipative losses and inductor core losses generally account for less than 2% of the total loss.

### Thermal Considerations

The maximum power dissipation depends on the thermal resistance of IC package, PCB layout, the rate of surroundings airflow and temperature difference between junction to ambient. The maximum power dissipation can be calculated by following formula :

$$P_{D(MAX)} = (T_{J(MAX)} - T_A) / \theta_{JA}$$

Where  $T_{J(MAX)}$  is the maximum operation junction temperature,  $T_A$  is the ambient temperature and the  $\theta_{JA}$  is the junction to ambient thermal resistance.

For recommended operating conditions specification of RT8016 DC/DC converter, where  $T_{J(MAX)}$  is the maximum junction temperature of the die and  $T_A$  is the maximum ambient temperature. The junction to ambient thermal resistance  $\theta_{JA}$  is layout dependent. For WDFN-6L 2x2 packages, the thermal resistance  $\theta_{JA}$  is 165°C/W on the standard JEDEC 51-7 four layers thermal test board.

The maximum power dissipation at  $T_A = 25^\circ\text{C}$  can be calculated by following formula :

$$P_{D(MAX)} = (125^\circ\text{C} - 25^\circ\text{C}) / 165^\circ\text{C/W} = 0.606\text{W for WDFN-6L 2x2 packages}$$

The maximum power dissipation depends on operating ambient temperature for fixed  $T_{J(MAX)}$  and thermal resistance  $\theta_{JA}$ .

For RT8016 packages, the Figure 5 of derating curves allows the designer to see the effect of rising ambient temperature on the maximum power allowed.

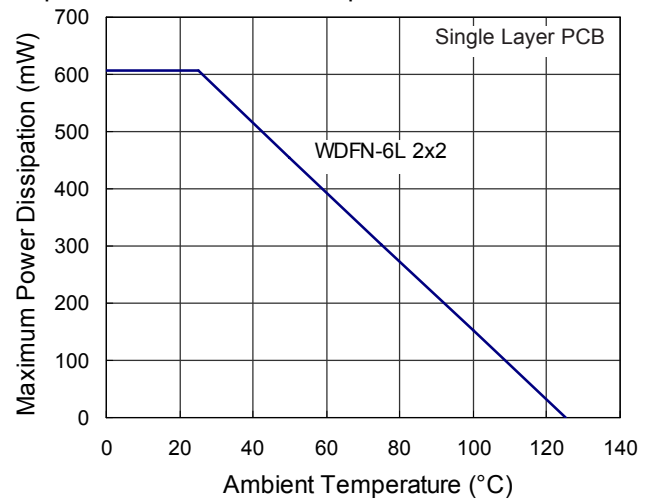

Figure 5. Derating Curves for RT8016 Package

### Checking Transient Response

The regulator loop response can be checked by looking at the load transient response. Switching regulators take several cycles to respond to a step in load current. When a load step occurs,  $V_{OUT}$  immediately shifts by an amount equal to  $\Delta I_{LOAD} (ESR)$ , where ESR is the effective series resistance of  $C_{OUT}$ .  $\Delta I_{LOAD}$  also begins to charge or discharge  $C_{OUT}$  generating a feedback error signal used by the regulator to return  $V_{OUT}$  to its steady-state value. During this recovery time,  $V_{OUT}$  can be monitored for overshoot or ringing that would indicate a stability problem.

### Layout Considerations

Follow the PCB layout guidelines for optimal performance of RT8016.

- ▶ For the main current paths as indicated in bold lines in Figure 6, keep their traces short and wide.
- ▶ Put the input capacitor as close as possible to the device pins ( $V_{IN}$  and GND).
- ▶ LX node is with high frequency voltage swing and should be kept small area. Keep analog components away from LX node to prevent stray capacitive noise pick-up.
- ▶ Connect feedback network behind the output capacitors. Keep the loop area small. Place the feedback components near the RT8016.

- ▶ Connect all analog grounds to a common node and then connect the common node to the power ground behind the output capacitors.
- ▶ An example of 2-layer PCB layout is shown in Figure 7 to Figure 8 for reference.

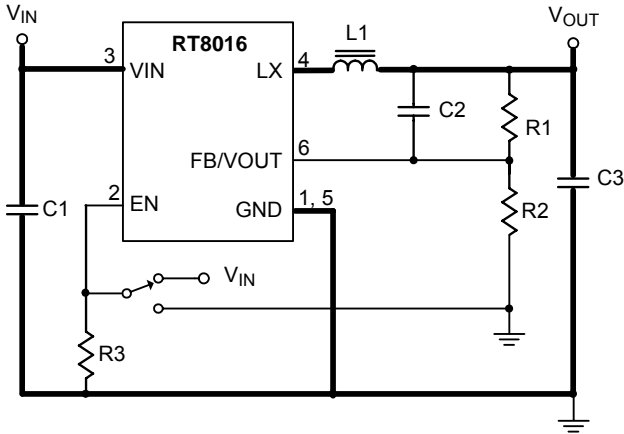

Figure 6. EVB Schematic

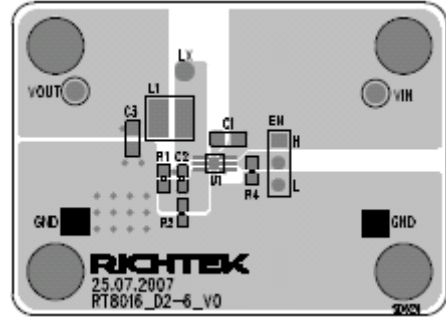

Figure 7. Top Layer

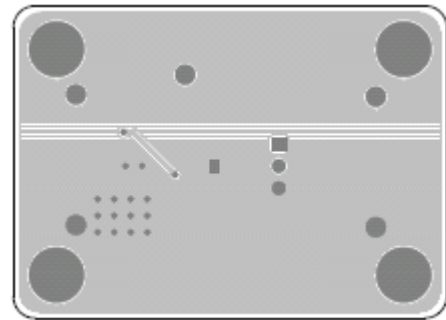

Figure 8. Bottom Layer

Table 1. Recommended Inductors

| Supplier    | Inductance (μH) | Current Rating (mA) | DCR (mΩ) | Dimensions (mm)    | Series   |
|-------------|-----------------|---------------------|----------|--------------------|----------|
| TAIYO YUDEN | 2.2             | 1480                | 60       | 3.00 x 3.00 x 1.50 | NR 3015  |
| GOTREND     | 2.2             | 1500                | 58       | 3.85 x 3.85 x 1.80 | GTSD32   |
| Sumida      | 2.2             | 1500                | 75       | 4.50 x 3.20 x 1.55 | CDRH2D14 |
| Sumida      | 4.7             | 1000                | 135      | 4.50 x 3.20 x 1.55 | CDRH2D14 |
| TAIYO YUDEN | 4.7             | 1020                | 120      | 3.00 x 3.00 x 1.50 | NR 3015  |
| GOTREND     | 4.7             | 1100                | 146      | 3.85 x 3.85 x 1.80 | GTSD32   |

Table 2. Recommended Capacitors for C<sub>IN</sub> and C<sub>OUT</sub>

| Supplier    | Capacitance (μF) | Package | Part Number       |
|-------------|------------------|---------|-------------------|
| TDK         | 4.7              | 603     | C1608JB0J475M     |
| MURATA      | 4.7              | 603     | GRM188R60J475KE19 |
| TAIYO YUDEN | 4.7              | 603     | JMK107BJ475RA     |
| TAIYO YUDEN | 10               | 603     | JMK107BJ106MA     |
| TDK         | 10               | 805     | C2012JB0J106M     |
| MURATA      | 10               | 805     | GRM219R60J106ME19 |
| MURATA      | 10               | 805     | GRM219R60J106KE19 |
| TAIYO YUDEN | 10               | 805     | JMK212BJ106RD     |

Outline Dimension

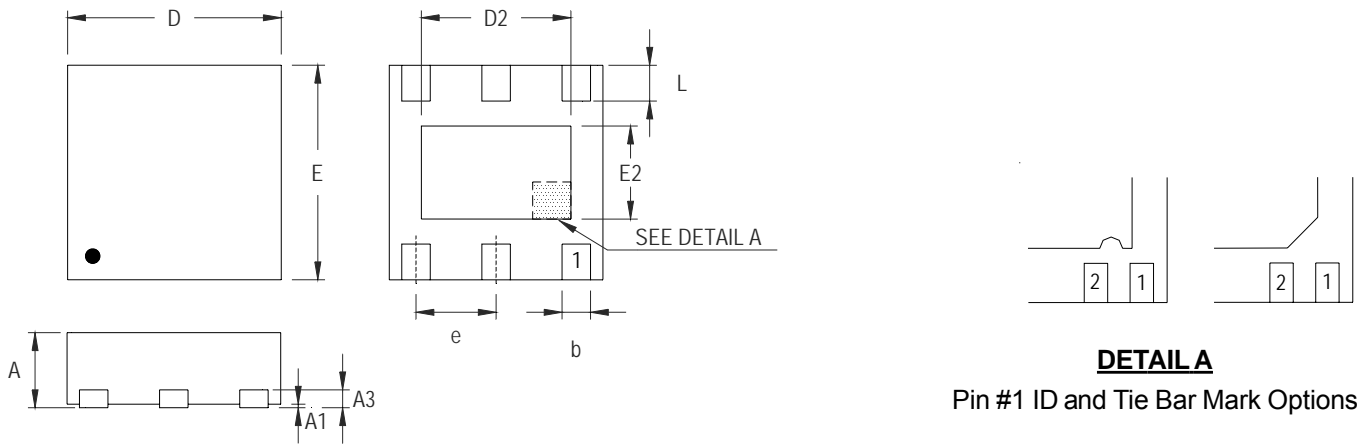

Note : The configuration of the Pin #1 identifier is optional, but must be located within the zone indicated.

| Symbol | Dimensions In Millimeters |       | Dimensions In Inches |       |
|--------|---------------------------|-------|----------------------|-------|
|        | Min                       | Max   | Min                  | Max   |
| A      | 0.700                     | 0.800 | 0.028                | 0.031 |
| A1     | 0.000                     | 0.050 | 0.000                | 0.002 |
| A3     | 0.175                     | 0.250 | 0.007                | 0.010 |
| b      | 0.200                     | 0.350 | 0.008                | 0.014 |
| D      | 1.950                     | 2.050 | 0.077                | 0.081 |
| D2     | 1.000                     | 1.450 | 0.039                | 0.057 |
| E      | 1.950                     | 2.050 | 0.077                | 0.081 |
| E2     | 0.500                     | 0.850 | 0.020                | 0.033 |
| e      | 0.650                     |       | 0.026                |       |
| L      | 0.300                     | 0.400 | 0.012                | 0.016 |

W-Type 6L DFN 2x2 Package

Richtek Technology Corporation

5F, No. 20, Taiyuen Street, Chupei City  
 Hsinchu, Taiwan, R.O.C.  
 Tel: (8863)5526789

Richtek products are sold by description only. Richtek reserves the right to change the circuitry and/or specifications without notice at any time. Customers should obtain the latest relevant information and data sheets before placing orders and should verify that such information is current and complete. Richtek cannot assume responsibility for use of any circuitry other than circuitry entirely embodied in a Richtek product. Information furnished by Richtek is believed to be accurate and reliable. However, no responsibility is assumed by Richtek or its subsidiaries for its use; nor for any infringements of patents or other rights of third parties which may result from its use. No license is granted by implication or otherwise under any patent or patent rights of Richtek or its subsidiaries.