

Dual-Output PWM Controller for AMD SVI2 CPU Power Supply

General Description

The RT8877C is a 4 + 2 phases PWM controller. Moreover, it is compliant with AMD SVI2 Voltage Regulator Specification to support both CPU core (VDD) and Northbridge portion of the CPU (VDDNB). The RT8877C features CCRCOT (Constant Current Ripple Constant On-Time) with G-NAVP (Green-Native AVP), which is a Richtek's proprietary topology. G-NAVP makes it an easy setting controller to meet all AMD AVP (Active Voltage Positioning) VDD/VDDNB requirements. The droop is easily programmed by setting the DC gain of the error amplifier. With proper compensation, the load transient response can achieve optimized AVP performance. The controller also uses the interface to issue VOTF Complete and to send digitally encoded voltage and current values for the VDD and VDDNB domains. It can operate in single phase and diode emulation mode and reach up to 90% efficiency in different modes according to different loading conditions. The RT8877C provides special purpose offset capabilities by pin setting. The RT8877C also provides power good indication, over current indication (OCP_L) and dual OCP mechanism for AMD SVI2 CPU core and NB. It also features complete fault protection functions including over voltage, under voltage and negative voltage.

Features

- 4/3/2/1-Phase (VDD) + 2/1/0-Phase (VDDNB) PWM Controller
- G-NAVP™ Topology
- Support Dynamic Load Line and Zero Load Line
- Diode Emulation Mode at Light Load Condition
- SVI2 Interface to Comply AMD Power Management Protocol
- Build-in ADC for V_{OUT} and I_{OUT} Reporting
- Immediate OV, UV and NV Protections and UVLO
- Programmable Dual OCP Mechanism
- 0.5% DAC Accuracy
- Fast Transient Response
- Power Good Indicator
- Over Current Indicator
- 52-Lead WQFN Package
- RoHS Compliant and Halogen Free

Applications

- AMD SVI2 CPU
- Desktop Computer

Simplified Application Circuit

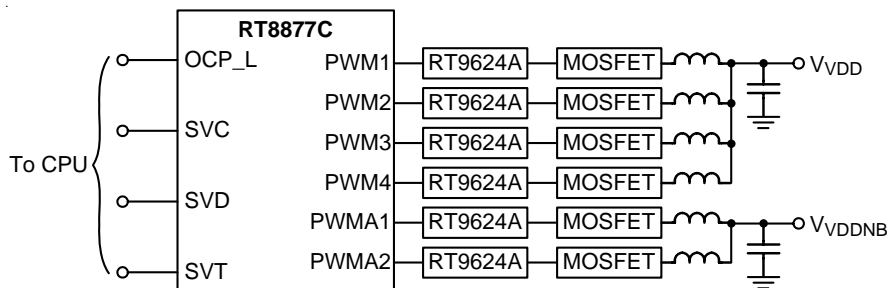

Ordering Information

RT8877C □ □

- Package Type
QW : WQFN-52L 6x6 (W-Type)
- Lead Plating System
Z : ECO (Ecological Element with Halogen Free and Pb free)

Note :

Richtek products are :

- ▶ RoHS compliant and compatible with the current requirements of IPC/JEDEC J-STD-020.
- ▶ Suitable for use in SnPb or Pb-free soldering processes.

Marking Information

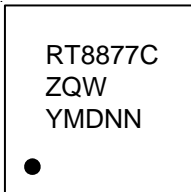

RT8877CZQW : Product Number
YMDNN : Date Code

Pin Configurations

(TOP VIEW)

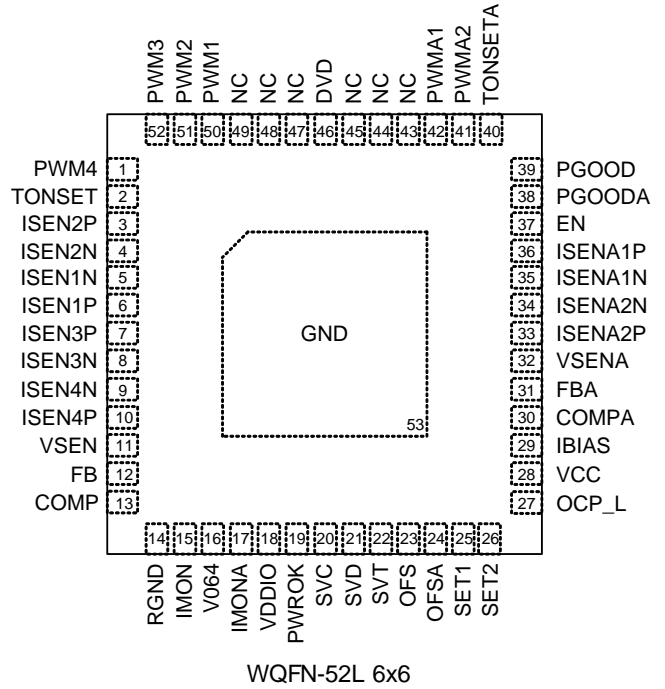

Functional Pin Description

Pin No.	Pin Name	Pin Function
1, 52, 51, 50	PWM4 to PWM1	PWM Outputs for Channel 1, 2, 3 and 4 of VDD Controller.
2	TONSET	VDD Controller On-Time Setting. Connect this pin to the converter input voltage, Vin, through a resistor, RTON, to set the on-time of UGATE and also the output voltage ripple of VDD controller.
5, 4, 8, 9	ISEN1N to ISEN4N	Negative Current Sense Input of Channel 1, 2, 3 and 4 for VDD Controller.
6, 3, 7, 10	ISEN1P to ISEN4P	Positive Current Sense Input of Channel 1, 2, 3 and 4 for VDD Controller.
11	VSEN	VDD Controller Voltage Sense Input. This pin is connected to the terminal of VDD controller output voltage.
12	FB	Output Voltage Feedback Input of VDD Controller. This pin is the negative input of the error amplifier for the VDD controller.
13	COMP	Error Amplifier Output Pin of the VDD Controller.
14	RGND	Return Ground of VDD and VDDNB Controller. This pin is the common negative input of output voltage differential remote sense for VDD and VDDNB controllers.
15	IMON	Current Monitor Output for the VDD Controller. This pin outputs a voltage proportional to the output current.
16	V064	Fixed 0.64V Reference Voltage Output. This voltage is only used to offset the output voltage of IMON pin and IMONA pin. Connect a 0.47μF capacitor from this pin to GND.
17	IMONA	Current Monitor Output for the VDDNB Controller. This pin outputs a voltage proportional to the output current.
18	VDDIO	Processor memory interface power rail and serves as the reference for PWROK, SVD, SVC and SVT. This pin is used by the VR to reference the SVI pins.
19	PWROK	System Power Good Input. If PWROK is low, the SVI interface is disabled and VR returns to BOOT-VID state with initial load line slope and initial offset. If PWROK is high, the SVI interface is running and the DAC decodes the received serial VID codes to determine the output voltage.
20	SVC	Serial VID Clock Input from Processor.
21	SVD	Serial VID Data input from Processor. This pin is a serial data line.
22	SVT	Serial VID Telemetry Input from VR. This pin is a push-pull output.
23	OFS	Over Clocking Offset Setting for the VDD Controller.
24	OFSA	Over Clocking Special Purpose Offset Setting for the VDDNB Controller.
25	SET1	OCP_TDC threshold setting individually for VDD and VDDNB controllers and also the internal ramp slew rate setting (RSET and RSETA) individually for VDD and VDDNB controllers
26	SET2	Quick response threshold setting individually for VDD and VDDNB controllers (QRTH and QRTHA) and also the OCP_TDC trigger delay time setting for both controllers and over clocking offset enable setting.
27	OCP_L	Over Current Indicator for Dual OCP Mechanism. This pin is an open drain output.
28	VCC	Controller Power Supply Input. Connect this pin to 5V with an 1μF or greater ceramic capacitor for decoupling.

Pin No.	Pin Name	Pin Function
29	IBIAS	Internal Bias Current Setting. Connect only a 100kΩ resistor from this pin to GND to generate bias current for internal circuit. Place this resistor as close to IBIAS pin as possible.
30	COMPA	Error Amplifier Output of the VDDNB Controller.
31	FBA	Output Voltage Feedback Input of VDDNB Controller. This pin is the negative input of the error amplifier for the VDDNB controller.
32	VSENA	VDDNB Controller Voltage Sense Input. This pin is connected to the terminal of VDDNB controller output voltage.
33, 36	ISENA2P, ISENA1P	Positive Current Sense Input of Channel 1 and 2 for VDDNB Controller.
34, 35	ISENA2N, ISENA1N	Negative Current Sense Input of Channel 1 and 2 for VDDNB Controller.
37	EN	Controller Enable pin. A logic high signal enables the controller.
38	PGOODA	Power Good Indicator for the VDDNB Controller. This pin is an open drain output.
39	PGOOD	Power Good Indicator for the VDD Controller. This pin is an open drain output.
40	TONSETA	VDDNB Controller On-Time Setting. Connect this pin to the converter input voltage, Vin, through a resistor, RTONNB, to set the on-time of UGATE_VDDNB and also the output voltage ripple of VDDNB controller.
41, 42	PWMA2, PWMA1	PWM Output for Channel 1 and 2 of VDDNB Controller.
43, 44, 45, 47, 48, 49	NC	No Internal Connection.
46	DVD	External Driver Power Supply Input Voltage Detection Pin.
53 (Exposed Pad)	GND	Ground. The exposed pad must be soldered to a large PCB and connected to GND for maximum power dissipation.

Function Block Diagram

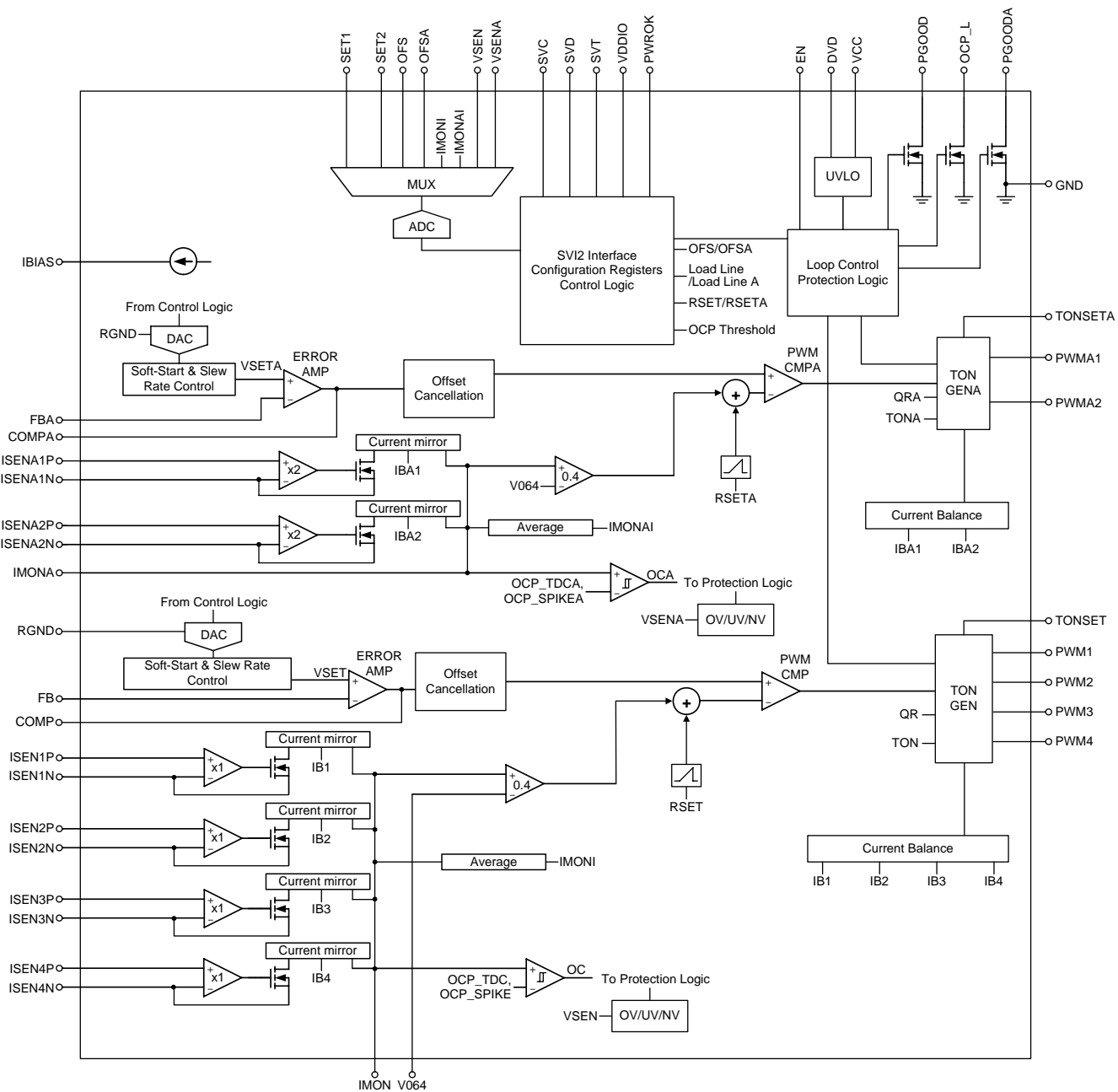

Operation

MUX and ADC

The MUX supports the inputs from SET1, SET2, OFS, OFSA, IMON, IMONA, VSEN, or VSENA. The ADC converts these analog signals to digital codes for reporting or performance adjustment.

SVI2 Interface

The SVI2 interface uses SVC, SVD, and SVT pins to communicate with CPU. RT8877C's performance and behavior can be adjusted by commands sent by CPU or platform.

UVLO

The UVLO detects DVD and VCC pin voltages for under voltage lockout protection and power on reset operation.

Loop Control Protection Logic

Loop control protection logic detects EN and UVLO signals to initiate soft-start function and control PGOOD, PGOODA and OCP_L signals after soft-start is finished. When OCP event is triggered, the OCP_L pin voltage will be pulled low.

DAC

The DAC receives VID codes from the SVI2 control logic to generate an internal reference voltage (VSET/VSETA) for controller.

Soft-Start and Slew-Rate Control

This block controls the slew rate of the internal reference voltage when output voltage changes.

Error Amp

Error amplifier generates COMP/COMP_A signal by the difference between VSET/VSETA and FB/FBA.

Offset cancellation

This block cancels the output offset voltage from voltage ripple and current ripple to achieve accurate output voltage.

PWM CMP_x

The PWM comparator compares COMP signal and current feedback signal to generate a signal for TONGEN_x.

TONGEN/TONGENA

This block generates an on-time pulse which high interval is based on the on-time setting and current balance.

Current Balance

Per-phase current is sensed and adjusted by adjusting on-time of each phase to achieve current balance for each phase.

OC/OV/UV/NV

VSEN/VSENA and output current are sensed for over current, over voltage, under voltage, and negative voltage protection.

RSET/RSETA

The Ramp generator is designed to improve noise immunity and reduce jitter.

Table 1. Serial VID Codes

SVID [7:0]	Voltage (V)	SVID [7:0]	Voltage (V)	SVID [7:0]	Voltage (V)	SVID [7:0]	Voltage (V)
0000_0000	1.55000	0010_0111	1.30625	0100_1110	1.06250	0111_0101	0.81875
0000_0001	1.54375	0010_1000	1.30000	0100_1111	1.05625	0111_0110	0.81250
0000_0010	1.53750	0010_1001	1.29375	0101_0000	1.05000	0111_0111	0.80625
0000_0011	1.53125	0010_1010	1.28750	0101_0001	1.04375	0111_1000	0.80000
0000_0100	1.52500	0010_1011	1.28125	0101_0010	1.03750	0111_1001	0.79375
0000_0101	1.51875	0010_1100	1.27500	0101_0011	1.03125	0111_1010	0.78750
0000_0110	1.51250	0010_1101	1.26875	0101_0100	1.02500	0111_1011	0.78125
0000_0111	1.50625	0010_1110	1.26250	0101_0101	1.01875	0111_1100	0.77500
0000_1000	1.50000	0010_1111	1.25625	0101_0110	1.01250	0111_1101	0.76875
0000_1001	1.49375	0011_0000	1.25000	0101_0111	1.00625	0111_1110	0.76250
0000_1010	1.48750	0011_0001	1.24375	0101_1000	1.00000	0111_1111	0.75625
0000_1011	1.48125	0011_0010	1.23750	0101_1001	0.99375	1000_0000	0.75000
0000_1100	1.47500	0011_0011	1.23125	0101_1010	0.98750	1000_0001	0.74375
0000_1101	1.46875	0011_0100	1.22500	0101_1011	0.98125	1000_0010	0.73750
0000_1110	1.46250	0011_0101	1.21875	0101_1100	0.97500	1000_0011	0.73125
0000_1111	1.45625	0011_0110	1.21250	0101_1101	0.96875	1000_0100	0.72500
0001_0000	1.45000	0011_0111	1.20625	0101_1110	0.96250	1000_0101	0.71875
0001_0001	1.44375	0011_1000	1.20000	0101_1111	0.95625	1000_0110	0.71250
0001_0010	1.43750	0011_1001	1.19375	0110_0000	0.95000	1000_0111	0.70625
0001_0011	1.43125	0011_1010	1.18750	0110_0001	0.94375	1000_1000	0.70000
0001_0100	1.42500	0011_1011	1.18125	0110_0010	0.93750	1000_1001	0.69375
0001_0101	1.41875	0011_1100	1.17500	0110_0011	0.93125	1000_1010	0.68750
0001_0110	1.41250	0011_1101	1.16875	0110_0100	0.92500	1000_1011	0.68125
0001_0111	1.40625	0011_1110	1.16250	0110_0101	0.91875	1000_1100	0.67500
0001_1000	1.40000	0011_1111	1.15625	0110_0110	0.91250	1000_1101	0.66875
0001_1001	1.39375	0100_0000	1.15000	0110_0111	0.90625	1000_1110	0.66250
0001_1010	1.38750	0100_0001	1.14375	0110_1000	0.90000	1000_1111	0.65625
0001_1011	1.38125	0100_0010	1.13750	0110_1001	0.89375	1001_0000	0.65000
0001_1100	1.37500	0100_0011	1.13125	0110_1010	0.88750	1001_0001	0.64375
0001_1101	1.36875	0100_0100	1.12500	0110_1011	0.88125	1001_0010	0.63750
0001_1110	1.36250	0100_0101	1.11875	0110_1100	0.87500	1001_0011	0.63125
0001_1111	1.35625	0010_0110	1.11250	0110_1101	0.86875	1001_0100	0.62500
0010_0000	1.35000	0100_0111	1.10625	0110_1110	0.86250	1001_0101	0.61875
0010_0001	1.34375	0100_1000	1.10000	0110_1111	0.85625	1001_0110	0.61250
0010_0010	1.33750	0100_1001	1.09375	0111_0000	0.85000	1001_0111	0.60625
0010_0011	1.33125	0100_1010	1.08750	0111_0001	0.84375	1001_1000	0.60000
0010_0100	1.32500	0100_1011	1.08125	0111_0010	0.83750	1001_1001	0.59375
0010_0101	1.31875	0100_1100	1.07500	0111_0011	0.83125	1001_1010	0.58750
0010_0110	1.31250	0100_1101	1.06875	0111_0100	0.82500	1001_1011	0.58125

SVID [7:0]	Voltage (V)	SVID [7:0]	Voltage (V)	SVID [7:0]	Voltage (V)	SVID [7:0]	Voltage (V)
1001_1100	0.57500	1011_0101 *	0.41875	1100_1110 *	0.26250	1110_0111*	0.10625
1001_1101	0.56875	1011_0110 *	0.41250	1100_1111 *	0.25625	1110_1000*	0.10000
1001_1110	0.56250	1011_0111 *	0.40625	1101_0000 *	0.25000	1110_1001*	0.09375
1001_1111	0.55625	1011_1000 *	0.40000	1101_0001 *	0.24375	1110_1010*	0.08750
1010_0000	0.55000	1011_1001 *	0.39375	1101_0010 *	0.23750	1110_1011*	0.08125
1010_0001	0.54375	1011_1010 *	0.38750	1101_0011 *	0.23125	1110_1100*	0.07500
1010_0010	0.53750	1011_1011 *	0.38125	1101_0100 *	0.22500	1110_1101*	0.06875
1010_0011	0.53125	1011_1100 *	0.37500	1101_0101 *	0.21875	1110_1110*	0.06250
1010_0100	0.52500	1011_1101 *	0.36875	1101_0110 *	0.21250	1110_1111*	0.05625
1010_0101	0.51875	1011_1110 *	0.36250	1101_0111 *	0.20625	1111_0000*	0.05000
1010_0110	0.51250	1011_1111 *	0.35625	1101_1000 *	0.20000	1111_0001*	0.04375
1010_0111	0.50625	1100_0000 *	0.35000	1101_1001 *	0.19375	1111_0010*	0.03750
1010_1000 *	0.50000	1100_0001 *	0.34375	1101_1010 *	0.18750	1111_0011*	0.03125
1010_1001 *	0.49375	1100_0010 *	0.33750	1101_1011 *	0.18125	1111_0100*	0.02500
1010_1010 *	0.48750	1100_0011 *	0.33125	1101_1100 *	0.17500	1111_0101*	0.01875
1010_1011 *	0.48125	1100_0100 *	0.32500	1101_1101 *	0.16875	1111_0110*	0.01250
1010_1100 *	0.47500	1100_0101 *	0.31875	1101_1110 *	0.16250	1111_0111*	0.00625
1010_1101 *	0.46875	1100_0110 *	0.31250	1101_1111 *	0.15625	1111_1000*	0.00000
1010_1110 *	0.46250	1100_0111 *	0.30625	1110_0000*	0.15000	1111_1001*	OFF
1010_1111 *	0.45625	1100_1000 *	0.30000	1110_0001*	0.14375	1111_1010*	OFF
1011_0000 *	0.45000	1100_1001 *	0.29375	1110_0010*	0.13750	1111_1011*	OFF
1011_0001 *	0.44375	1100_1010 *	0.28750	1110_0011*	0.13125	1111_1100*	OFF
1011_0010 *	0.43750	1100_1011 *	0.28125	1110_0100*	0.12500	1111_1101*	OFF
1011_0011 *	0.43125	1100_1100 *	0.27500	1110_0101*	0.11875	1111_1110*	OFF
1011_0100 *	0.42500	1100_1101 *	0.26875	1110_0110*	0.11250	1111_1111*	OFF

* Indicates TOB is 80mV for this VID code; unconditional VR controller stability required at all VID codes

Table 2. SET1 Pin Setting for VDD Controller

SET1 Pin Voltage Before Current Injection V _{SET1} (mV)	OCP_TDC (Respect to OCP_SPIKE)	RSET	SET1 Pin Voltage Before Current Injection V _{SET1} (mV)	OCP_TDC (Respect to OCP_SPIKE)	RSET
34	45%	145%	836	65%	145%
59		130%	861		130%
85		115%	886		115%
110		100%	911		100%
135		85%	936		85%
160		70%	961		70%
235	50%	145%	1036	70%	145%
260		130%	1061		130%
285		115%	1086		115%
310		100%	1112		100%
335		85%	1137		85%
360		70%	1162		70%
435	55%	145%	1237	75%	145%
460		130%	1262		130%
485		115%	1287		115%
510		100%	1312		100%
535		85%	1337		85%
560		70%	1362		70%
636	60%	145%	1437	Disable	145%
661		130%	1462		130%
686		115%	1487		115%
711		100%	1512		100%
736		85%	1537		85%
761		70%	1562		70%

Table 3. SET1 Pin Setting for VDDNB Controller

SET1 Pin Voltage Difference ΔV_{SET1} (Before and After Current Injection) (mV)	OCP_TDCA (Respect to OCP_SPIKEA)	RSETA	SET1 Pin Voltage Difference ΔV_{SET1} (Before and After Current Injection) (mV)	OCP_TDCA (Respect to OCP_SPIKEA)	RSETA
34	45%	145%	836	65%	145%
59		130%	861		130%
85		115%	886		115%
110		100%	911		100%
135		85%	936		85%
160		70%	961		70%
235	50%	145%	1036	70%	145%
260		130%	1061		130%
285		115%	1086		115%
310		100%	1112		100%
335		85%	1137		85%
360		70%	1162		70%
435	55%	145%	1237	75%	145%
460		130%	1262		130%
485		115%	1287		115%
510		100%	1312		100%
535		85%	1337		85%
560		70%	1362		70%
636	60%	145%	1437	Disable	145%
661		130%	1462		130%
686		115%	1487		115%
711		100%	1512		100%
736		85%	1537		85%
761		70%	1562		70%

Table 4. SET2 Pin Setting

SET2 Pin Voltage Before Current Injection V_{SET2} (mV)	QRTH (for VDD)	OCPTRGDELAY [1:0]	OCPTRGDELAY (for VDD/VDDNB)
19	Disable	00	10ms
72		01	20ms
122		10	30ms
172		11	40ms
222	35mV	00	10ms
272		01	20ms
323		10	30ms
373		11	40ms
423	39mV	00	10ms
473		01	20ms
523		10	30ms
573		11	40ms
623	43mV	00	10ms
673		01	20ms
723		10	30ms
773		11	40ms
823	47mV	00	10ms
874		01	20ms
924		10	30ms
974		11	40ms
1024	51mV	00	10ms
1074		01	20ms
1124		10	30ms
1174		11	40ms
1224	55mV	00	10ms
1274		01	20ms
1324		10	30ms
1375		11	40ms
1425	60mV	00	10ms
1475		01	20ms
1525		10	30ms
1575		11	40ms

Table 5. Quick Response Threshold for VDDNB Controller

SET2 Pin Voltage Difference ΔV_{SET2} (Before and After Current Injection) (mV)	OFSENABLE	OFSAENABLE	QRTH [2:0]	QRTHA (for VDDNB)
19	0	0	000	Disable
72			001	35mV
122			010	39mV
172			011	43mV
222			100	47mV
272			101	51mV
323			110	55mV
373			111	59mV
423		1	000	Disable
473			001	35mV
523			010	39mV
573			011	43mV
623			100	47mV
673			101	51mV
723			110	55mV
773			111	59mV
823	1	0	000	Disable
874			001	35mV
924			010	39mV
974			011	43mV
1024			100	47mV
1074			101	51mV
1124			110	55mV
1174			111	59mV
1224		1	000	Disable
1274			001	35mV
1324			010	39mV
1375			011	43mV
1425			100	47mV
1475			101	51mV
1525			110	55mV
1575			111	59mV

Absolute Maximum Ratings (Note 1)

- VCC to GND ----- -0.3V to 6.5V
- RGND to GND ----- -0.3V to 0.3V
- TONSET to GND ----- -0.3V to 28V
- Other Pins ----- -0.3V to (V_{CC} + 0.3V)
- Power Dissipation, P_D @ T_A = 25°C
 WQFN-52L 6x6 ----- 3.77W
- Package Thermal Resistance (Note 2)
 WQFN-52L 6x6, θ_{JA} ----- 26.5°C/W
 WQFN-52L 6x6, θ_{JC} ----- 6.5°C/W
- Junction Temperature ----- 150°C
- Lead Temperature (Soldering, 10 sec.) ----- 260°C
- Storage Temperature Range ----- -65°C to 150°C
- ESD Susceptibility (Note 3)
 HBM (Human Body Model) ----- 2kV

Recommended Operating Conditions (Note 4)

- Supply Voltage, VCC ----- 4.5V to 5.5V
- Junction Temperature Range ----- -40°C to 125°C
- Ambient Temperature Range ----- -40°C to 85°C

Electrical Characteristics

(V_{CC} = 5V, T_A = 25°C, unless otherwise specified)

Parameter	Symbol	Test Conditions	Min	Typ	Max	Unit
Input Power Supply						
Supply Current	I _{VCC}	EN = 3V, Not Switching	--	--	12	mA
Shutdown Current	I _{SHDN}	EN = 0V	--	--	5	μA
Reference and DAC						
DC Accuracy	V _{FB}	V _{FB} = 1.0000 – 1.5500 (No Load, CCM Mode)	-0.5	0	0.5	%SVID
		V _{FB} = 0.8000 – 1.0000	-5	0	5	mV
		V _{FB} = 0.3000 – 0.8000	-8	0	8	
		V _{FB} = 0.2500 – 0.3000	-80	0	80	
RGND Current						
RGND Current	I _{RGND}	EN = 3V, Not Switching	--	--	200	μA
Slew Rate						
Dynamic VID Slew Rate	SR	SetVID Fast	7.5	12	--	mV/μs
Error Amplifier						
Input Offset	V _{EAOFS}		--	--	2	mV
DC Gain	ADC	R _L = 47kΩ	70	80	--	dB
Gain-Bandwidth Product	GBW	C _{LOAD} = 5pF	--	10	--	MHz
Output Voltage Range	V _{COMP}		0.3	--	3.6	V
Maximum Source Current	IEA, SRC		1	--	--	mA
Maximum Sink Current	IEA, SNK		1	--	--	mA

Parameter	Symbol	Test Conditions	Min	Typ	Max	Unit
Current Sense Amplifier						
Input Offset Voltage	V _{OCS}		-0.2	--	0.2	mV
Current Mirror Gain for CORE	A _{MIRROR, VDD}		97	--	103	%
Current Mirror Gain for NB	A _{MIRROR, VDDNB}		194	--	206	%
Impedance at Negative Input	R _{ISEN_xN}		1	--	--	MΩ
Impedance at Positive Input	R _{ISEN_xP}		1	--	--	MΩ
Internal Sum Current Sense DC Gain for CORE	A _{i, VDD}	VDD Controller	--	0.4	--	V/V
Internal Sum Current Sense DC Gain for NB	A _{i, VDDNB}	VDDNB Controller	--	0.8	--	V/V
Maximum Source Current	ICS, SRC	0 < V _{FB} < 2.35	100	--	--	μA
Maximum Sink Current	ICS, SNK	0 < V _{FB} < 2.35	12	--	--	μA
Zero Current Detection						
Zero Current Detection Threshold	V _{ZCD_TH}	V _{ZCD_TH} = GND - V _{PHASEx}	--	1	--	mV
Ton Setting						
TONSETx Pin Minimum Voltage	V _{TON, MIN}		--	0.5	--	V
TONSETx Ton	T _{ON}	I _{RTON} = 80μA, V _{FB} = 1.1V	270	305	340	ns
TONSETx Input Current Range	I _{RTON}	V _{FB} = 1.1V	25	--	280	μA
Minimum TOFF	T _{OFF}		--	250	--	ns
IBIAS						
IBIAS Pin Voltage	V _{IBIAS}	R _{IBIAS} = 100k	1.97	2	2.03	V
V064						
Reference Voltage Output	V ₀₆₄		0.61	0.64	0.67	V
Sink Current Capability	I _{V064, SNK}	V ₀₆₄ = 0.64V	800	--	--	μA
Source Current Capability	I _{V064, SRC}		--	--	100	μA
Board OFSx						
VFB Limit	V _{FB, LIMIT}		0	--	2.35	V
OFS Update Rate	F _{OFS}		--	50	--	kHz
Board Offset Resolution	ΔV _{OFS}		--	6.25	--	mV
Logic Inputs						
EN Input Voltage	Logic-High	V _{IH_EN}	2	--	--	V
	Logic-Low	V _{IL_EN}	--	--	0.8	
Leakage Current of EN	I _{LEK_EN}		-1	--	1	μA
SVC, SVD, SVT, PWROK	Logic-High	V _{IH_SVI}	70	--	100	%
	Logic-Low	V _{IL_SVI}	0	--	35	
Hysteresis of SVC, SVD, SVT, PWROK	V _{HYS_SVI}	Respect to VDDIO	10	--	--	%

Parameter	Symbol	Test Conditions	Min	Typ	Max	Unit
Protection						
Under Voltage Lockout Threshold	V _{UVLO}	V _{CC} Falling edge	4	4.2	4.4	V
Under Voltage Lockout Hysteresis	ΔV _{UVLO}		--	100	--	mV
Under Voltage Lockout Delay	T _{UVLO}	V _{CC} Rising above UVLO Threshold	--	3	--	μs
Over Voltage Protection Threshold	V _{OVP}		275	325	375	mV
Over Voltage Protection Delay	T _{OVP}	V _{SEN} Rising above Threshold	--	1	--	μs
Under Voltage Protection Threshold	V _{UVP}		-375	-325	-275	mV
Under Voltage Protection Delay	T _{UVP}	V _{SEN} Falling below Threshold	--	3	--	μs
Negative Voltage Protection Threshold	V _{NV}		--	0	--	mV
Per Phase OCP Threshold	I _{OCP_PERPHASE}	I _{SENxN} Per-Phase OCP Threshold.	--	10	--	μA
Delay of Per Phase OCP	T _{PHOCP}		--	1	--	μs
OCP_SPIKE Threshold	I _{OCP_SPIKE}	DCR = 0.95mΩ, R _{SENSE} = 680Ω, R _{IMON} = 10kΩ	162	180	198	A
OCP_SPIKE Action Delay	T _{OCPSPIKE_ACTION_DLY}		6	--	12	μs
OCP_TDC Action Delay	T _{OCP_TDC_ACTION_DLY}		12	--	24	μs
OCP_L, PGOOD and PGOODA						
Output Low Voltage at OCP_L	V _{OCP_L}	I _{OCP_L} = 4mA	0	--	0.2	V
OCP_L Assertion Time	T _{OCP_L}		2	--	--	μs
Output Low Voltage at PGOOD, PGOODA	V _{PGOOD} , V _{PGOODA}	I _{PGOOD} = 4mA, I _{PGOODA} = 4mA	0	--	0.2	V
PGOOD and PGOODA Threshold Voltage	V _{TH_PGOOD} , V _{TH_PGOODA}	Respect to V _{BOOT}	--	-300	--	mV
PGOOD and PGOODA Delay Time	T _{PGOOD} , T _{PGOODA}	V _{SEN} = V _{BOOT} to PGOOD/PGOODA High	70	100	130	μs
Current Report						
Maximum Reported Current (FFh = OCP)			--	100	--	%IDD_SP IKE_OCP
Minimum Reported Current (00h)			--	0	--	%IDD_SP IKE_OCP
IDD Spike Current Accuracy			--	--	3	%

Parameter	Symbol	Test Conditions	Min	Typ	Max	Unit
Voltage Report						
Maximum Reported Voltage (0_00h)			--	3.15	--	V
Minimum Reported Voltage (1_F8h)			--	0	--	V
Voltage Accuracy			-2	--	2	LSB
QR Setting of VDD and VDDNB						
Quick Response Threshold Voltage Setting Range Minimum Value	V _{QRTH, MINx}	QRTHx [2:0] = [001]	--	35	--	mV
Quick Response Threshold Voltage Setting Range Maximum Value	V _{QRTH, MAXx}	QRTHx [2:0] = [111]	--	60	--	mV
PWM Driving Capability						
PWMx Source Resistance	R _{PWM_SRC}		--	20	--	Ω
PWMx Sink Resistance	R _{PWM_SNK}		--	10	--	Ω

Note 1. Stresses beyond those listed “Absolute Maximum Ratings” may cause permanent damage to the device. These are stress ratings only, and functional operation of the device at these or any other conditions beyond those indicated in the operational sections of the specifications is not implied. Exposure to absolute maximum rating conditions may affect device reliability.

Note 2. θ_{JA} is measured at T_A = 25°C on a high effective thermal conductivity four-layer test board per JEDEC 51-7. θ_{JC} is measured at the exposed pad of the package.

Note 3. Devices are ESD sensitive. Handling precaution is recommended.

Note 4. The device is not guaranteed to function outside its operating conditions.

Typical Application Circuit

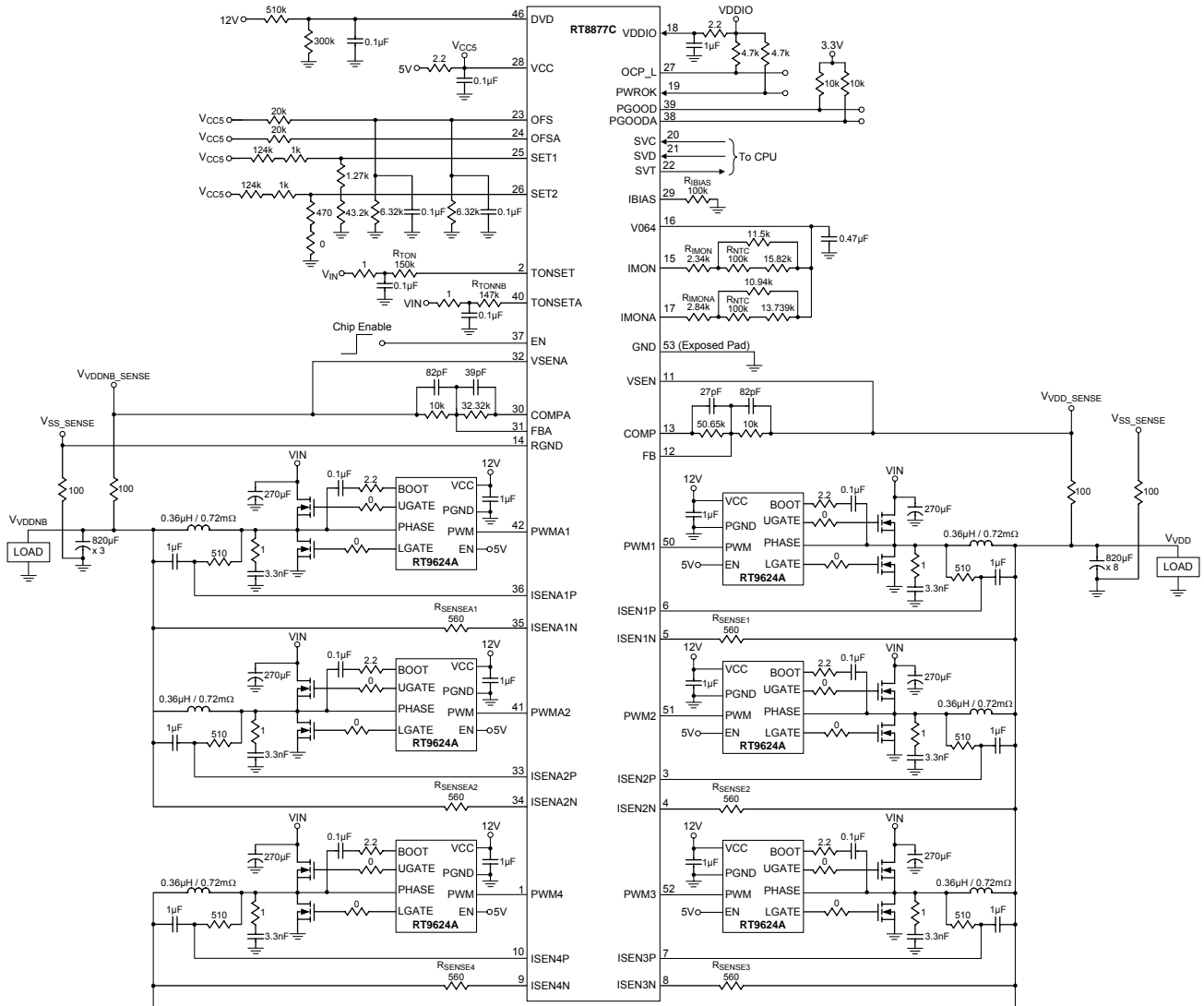

Typical Operating Characteristics

CORE VR Power On from EN

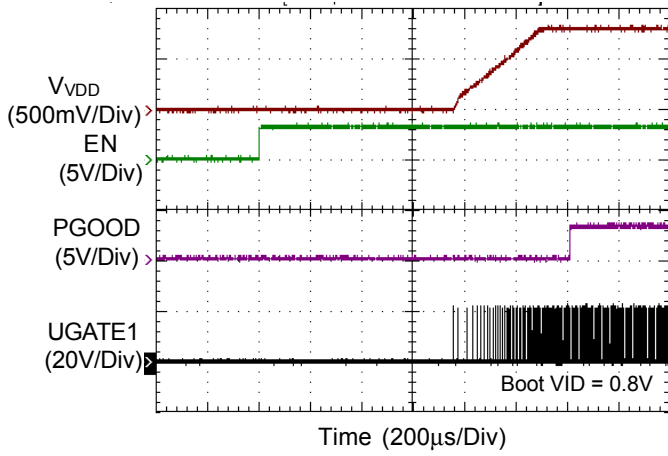

CORE VR Power Off from EN

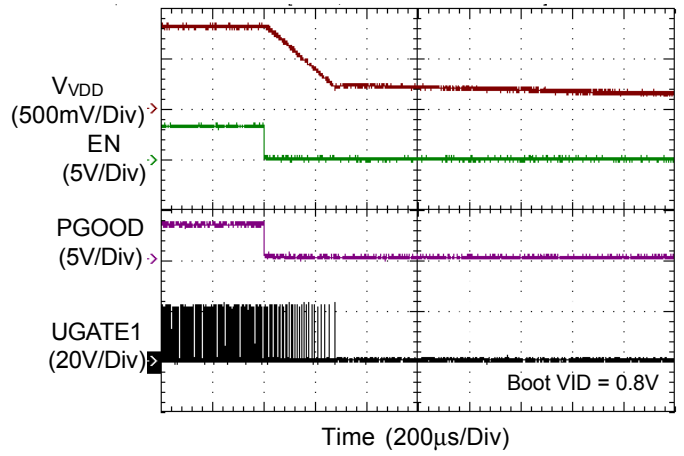

CORE VR OCP_TDC

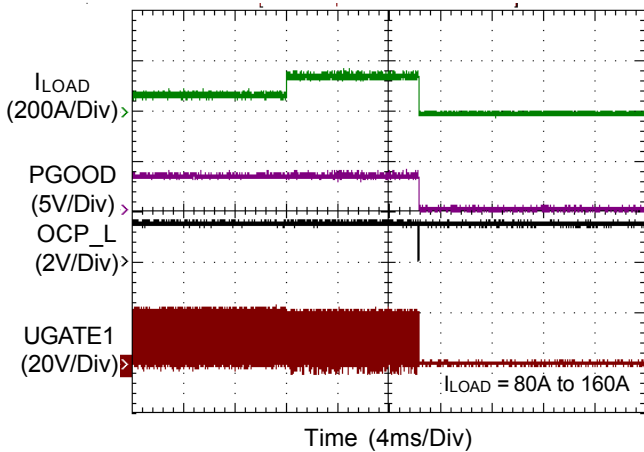

CORE VR OCP_SPIKE

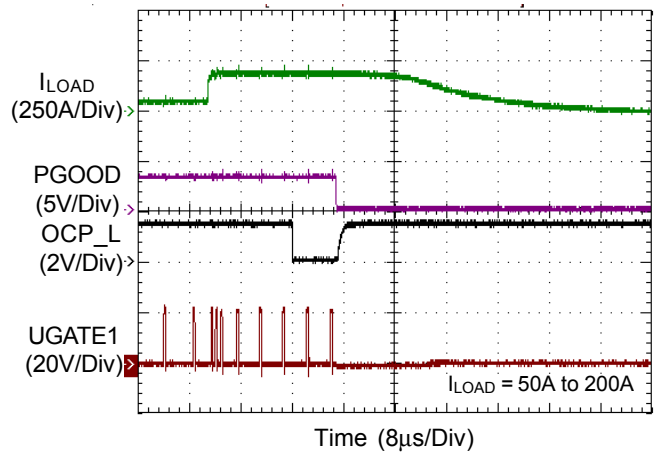

CORE VR OVP and NVP

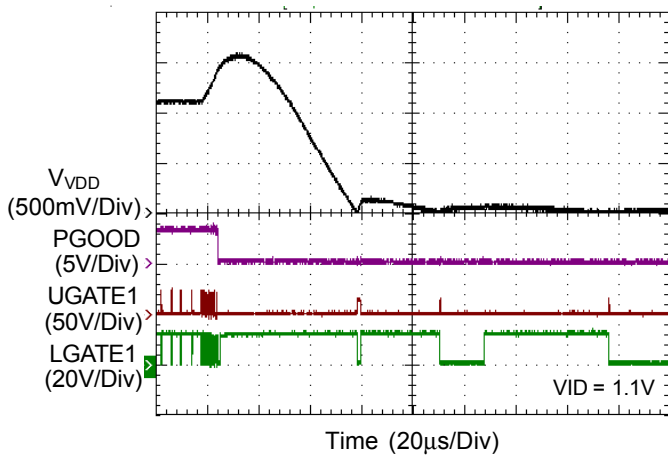

CORE VR UVP

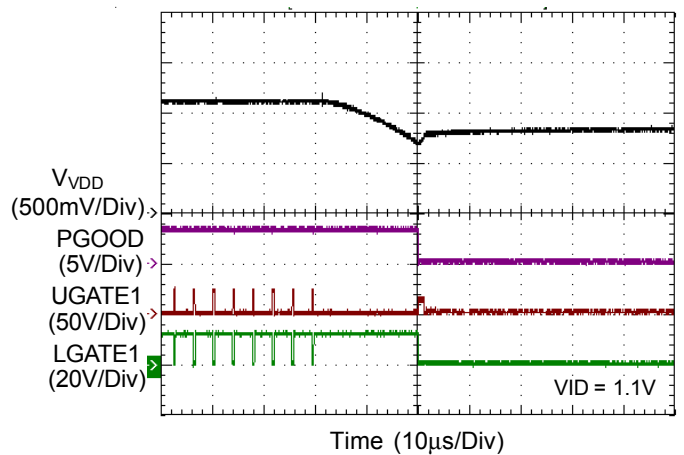

CORE VR Dynamic VID Up

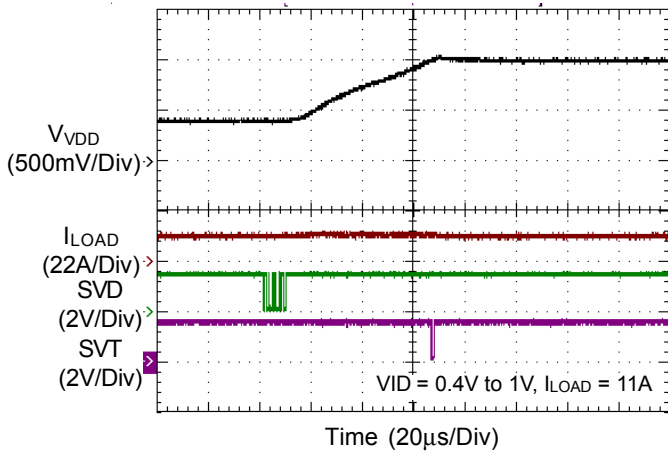

CORE VR Dynamic VID Up

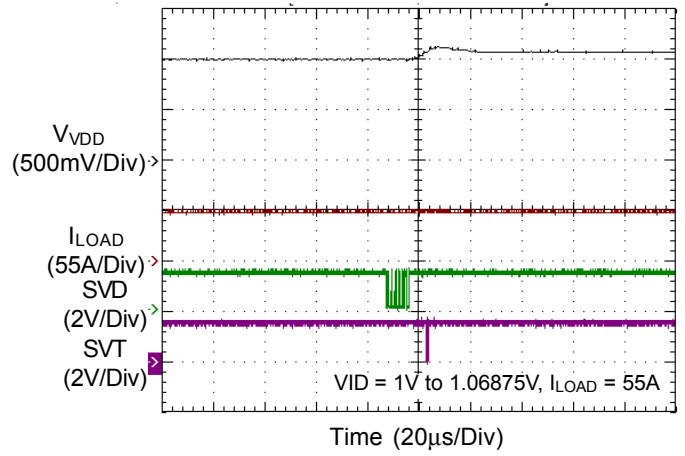

CORE VR Dynamic VID Up

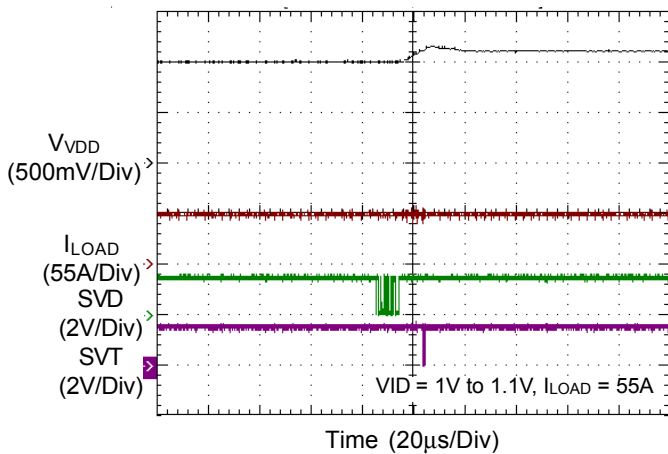

CORE VR Dynamic VID Up

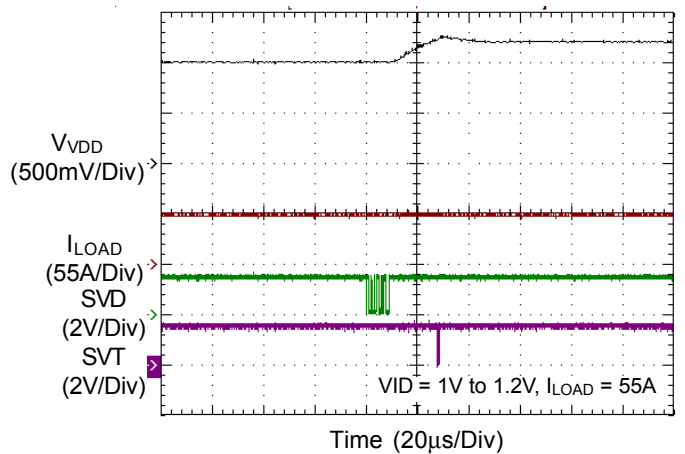

CORE VR Dynamic VID Up

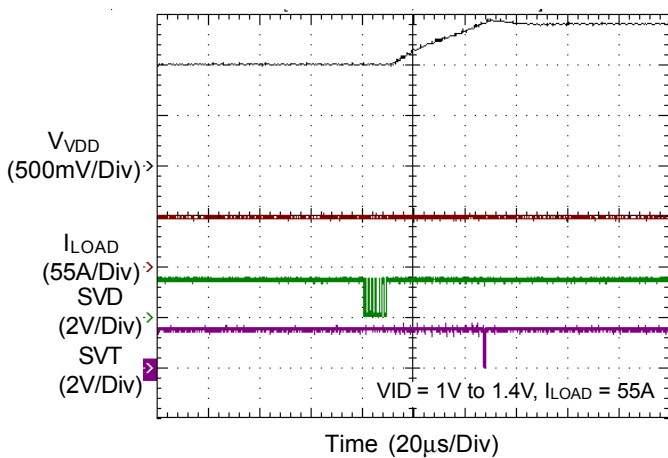

CORE VR Load Transient

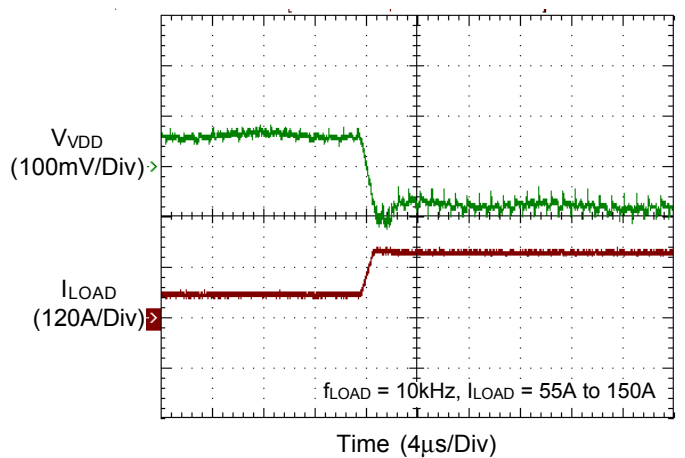

CORE VR Load Transient

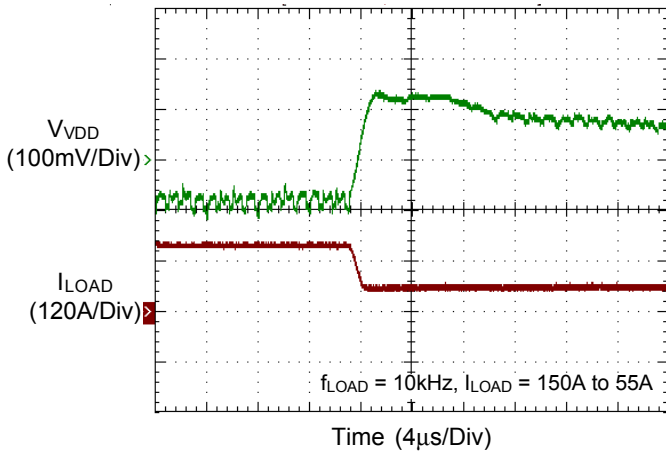

NB VR Power On from EN

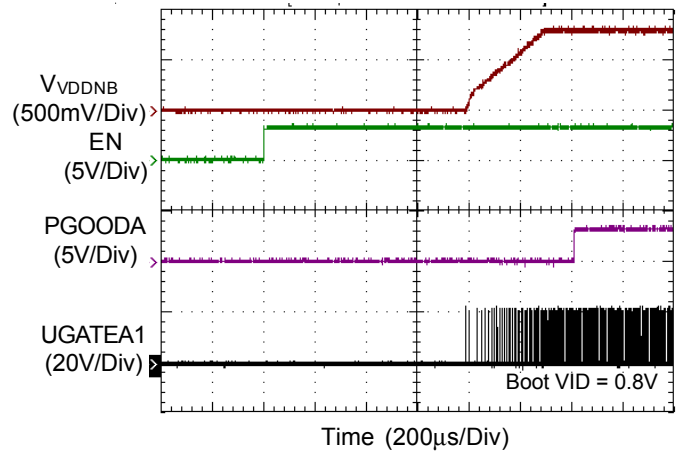

NB VR Power Off from EN

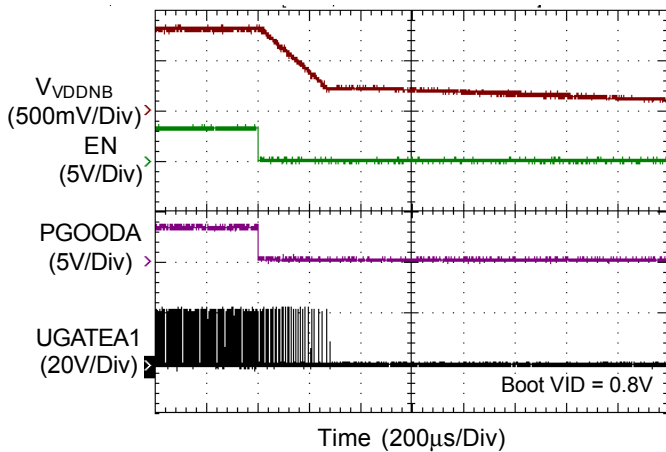

NB VR OCP_TDC

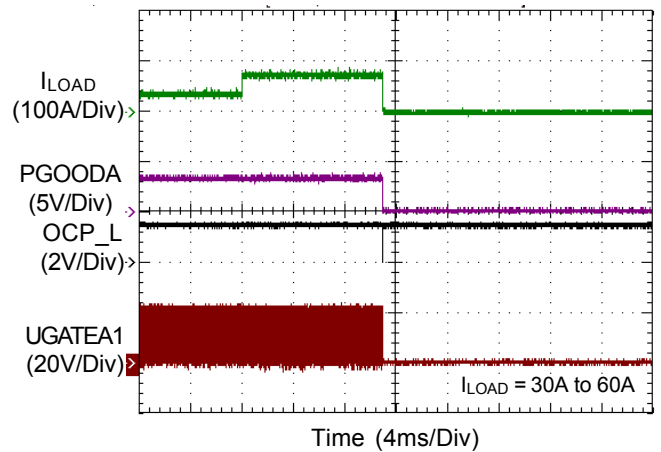

NB VR OCP_SPIKE

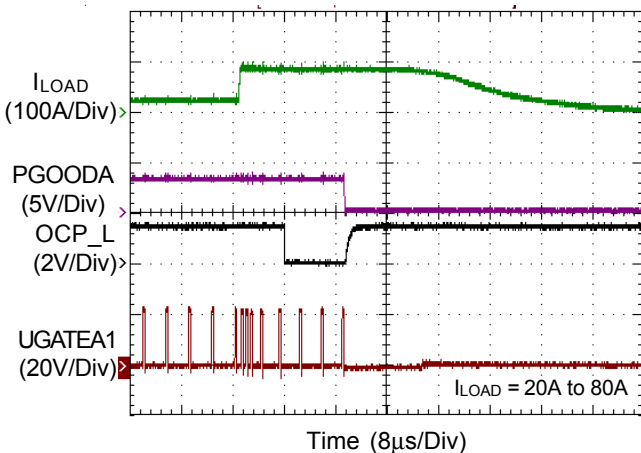

NB VR OVP and NVP

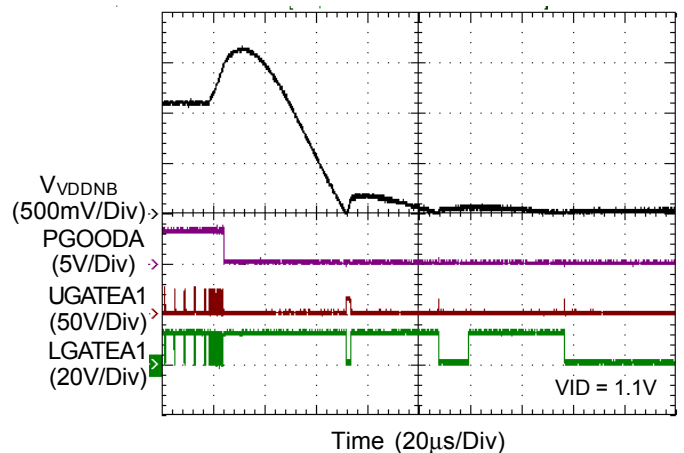

NB VR UVP

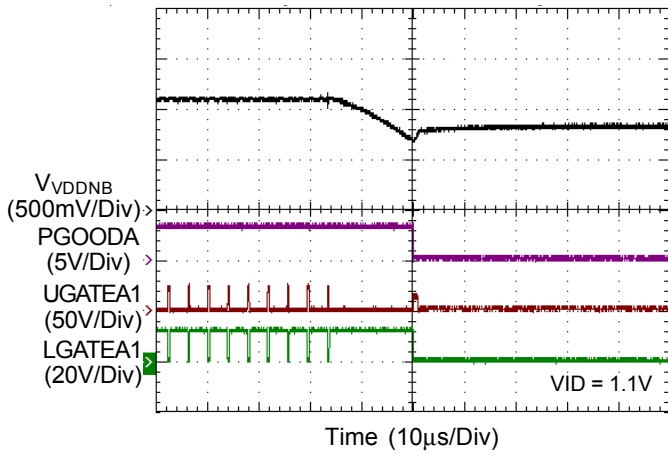

NB VR Dynamic VID Up

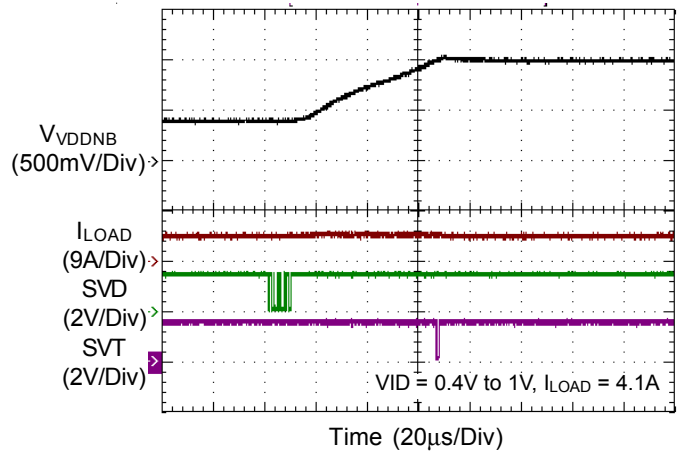

NB VR Dynamic VID Up

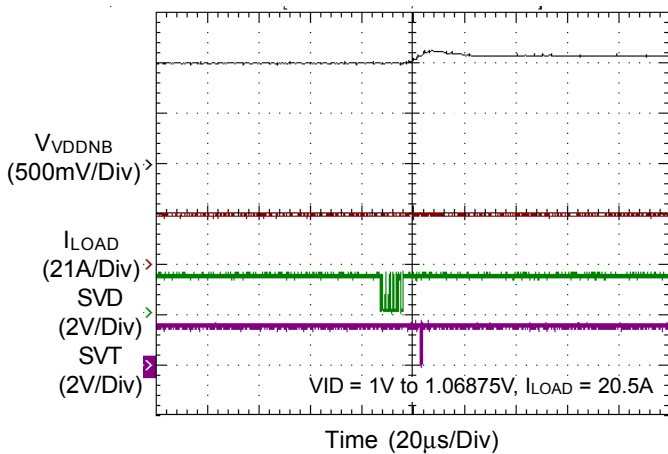

NB VR Dynamic VID Up

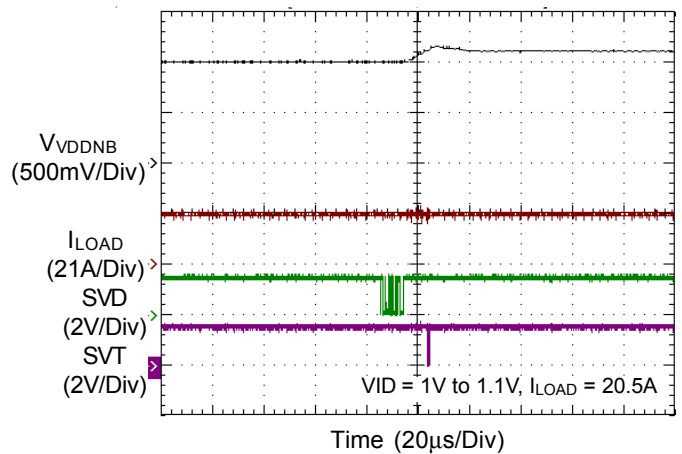

NB VR Dynamic VID Up

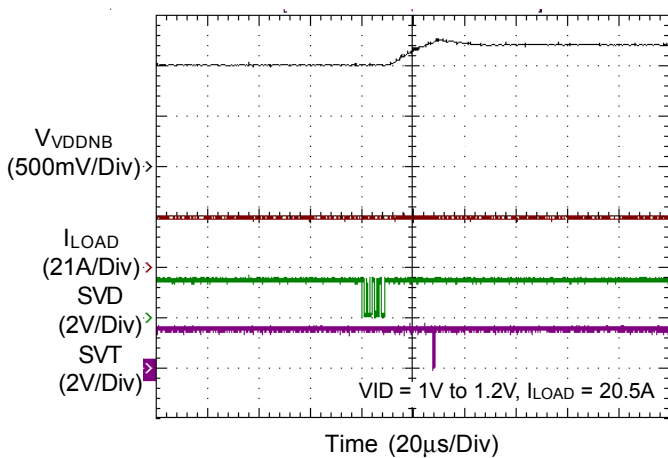

NB VR Dynamic VID Up

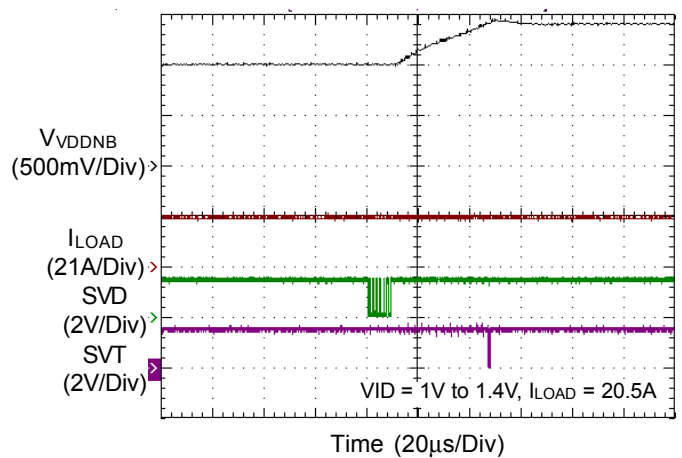

NB VR Load Transient

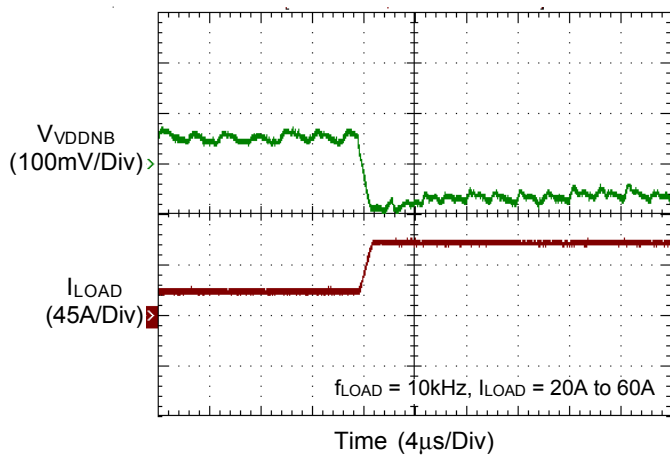

NB VR Load Transient

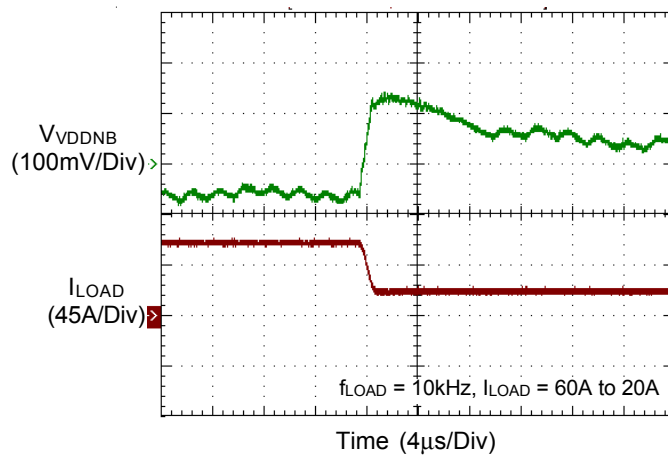

Application Information

Power Ready (POR) Detection

During start-up, the RT8877C will detect the voltage at the voltage input pins : VCC, EN and DVD. When $V_{CC} > 4.2V$ and $V_{DVD} > 2.2V$, the IC will recognize the power state of system to be ready (POR = high) and wait for enable command at the EN pin. After POR = high and $V_{EN} > 2V$, the IC will enter start-up sequence for both VDD rail and VDDNB rail. If the voltage at any voltage input pin drops below low threshold (POR = low), the IC will enter power down sequence and all the functions will be disabled. Normally, connecting system power to the EN pin and power stage VIN (12V, through a voltage divider) to the DVD pin is recommended. The SVID will be ready in 2ms (max) after the chip has been enabled. All the protection latches (OVP, OCP, UVP) will be cleared only after POR = low. The condition of $V_{EN} = \text{low}$ will not clear these latches. While VDD and VDDNB regulate, DVD falls lower than 1.5V. Then IC will shut down immediately until POR recycle.

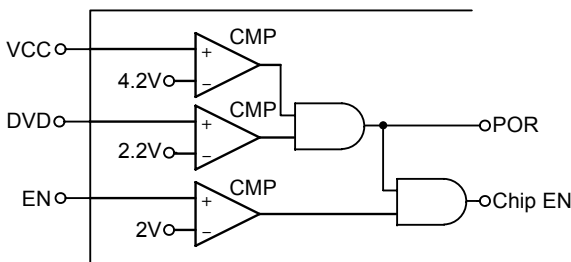

Figure 1. Power Ready (POR) Detection

Precise Reference Current Generation

The RT8877C includes complicated analog circuits inside the controller. The IC needs very precise reference voltage/current to drive these analog circuits. The IC will auto generate a 2V voltage source at IBIAS pin, and a 100kΩ resistor is required to be connected between IBIAS and analog ground, as shown in Figure 2. Through this connection, the IC will generate a 20μA current from the IBIAS pin to analog ground, and this 20μA current will be mirrored for internal use. Note that other type of connection or other values of resistance applied at the IBIAS pin may cause functional failure, such as slew rate control, OFS

accuracy, etc. In other words, the IBIAS pin can only be connected with a 100kΩ resistor to GND. The resistance accuracy of this resistor is recommended to be 1% or higher.

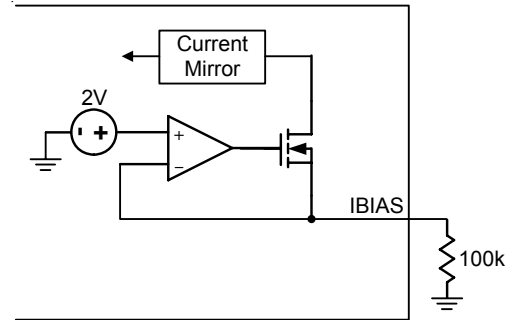

Figure 2. IBIAS Setting

Boot VID

When EN goes high, both VDD and VDDNB output begin to soft-start to the boot VID in CCM. Table 6 shows the Boot VID setting. The Boot VID is determined by the SVC and SVD input states at EN rising edge and it is stored in the internal register. The digital soft-start circuit ramps up the reference voltage at a controlled slew rate to reduce inrush current during start up. When all the output voltages are above power good threshold (300mV below Boot VID) at the end of soft-start, the controller asserts power good after a time delay.

Table 6. 2-Bit Boot VID Code

Initial Startup VID (Boot VID)		
SVC	SVD	VDD/VDDNB Output Voltage (V)
0	0	1.1
0	1	1.0
1	0	0.9
1	1	0.8

Start-Up Sequence

After EN goes high, the RT8877C starts up and operates according to the initial settings. Figure 3 shows the simplified sequence timing diagram. The detailed operation is described in the following.

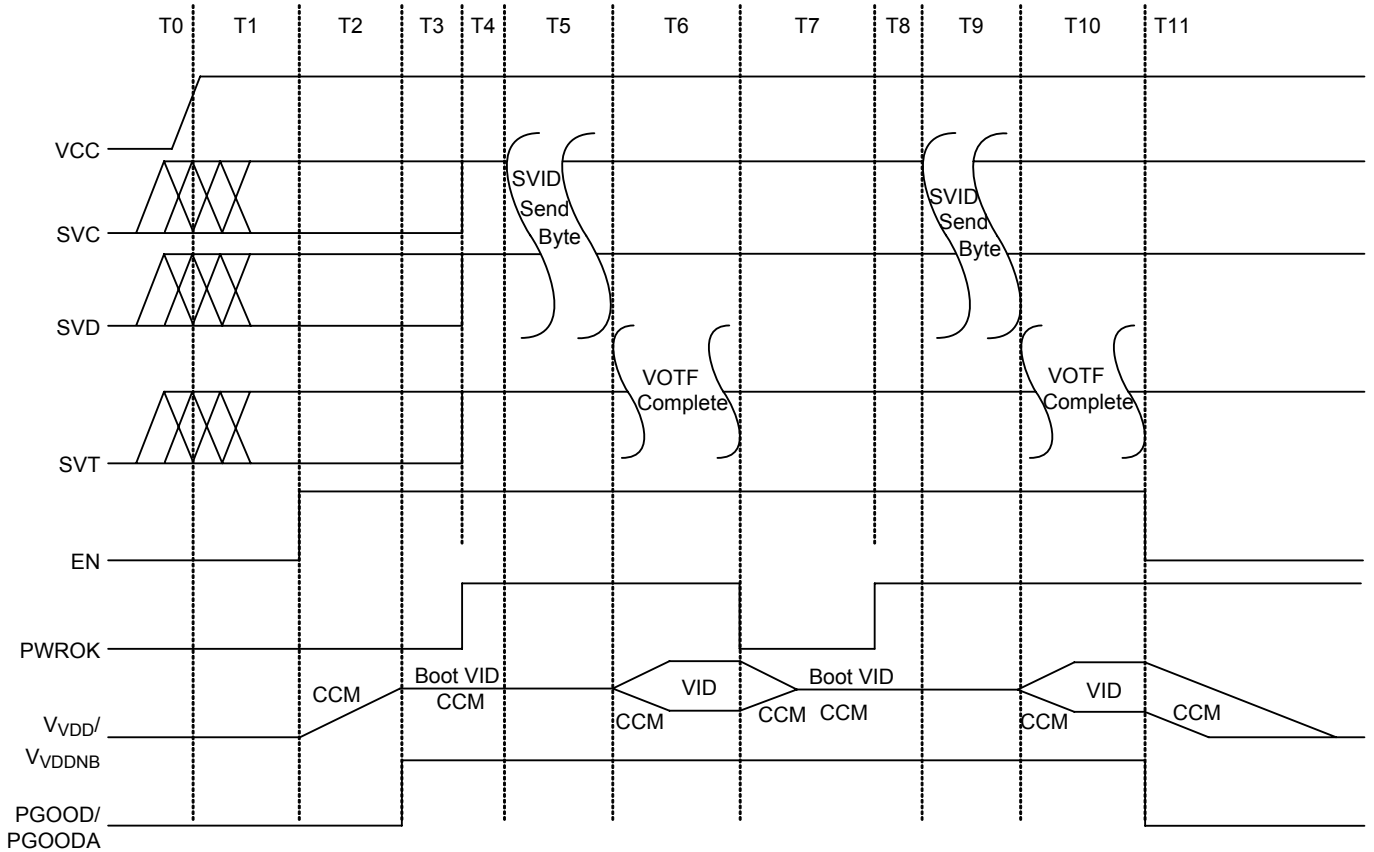

Figure 3. Simplified Sequence Timing Diagram

Description of Figure 3 :

T0 : The RT8877C waits for VCC POR.

T1 : The SVC pin and SVD pin set the Boot VID. Boot VID is latched at EN rising edge. SVT is driven high by the RT8877C.

T2 : The enable signal goes high and all output voltages ramp up to the Boot VID in CCM. The soft-start slew rate is 3mV/μs.

T3 : All output voltages are within the regulation limits and the PGOOD and PGOODA signal goes high.

T4 : The PWROK pin goes high and the SVI2 interface starts running. The RT8877C waits for SVID command from processor.

T5 : A valid SVID command transaction occurs between the processor and the RT8877C.

T6 : The RT8877C starts VOTF (VID-on-the-fly) transition according to the received SVID command and send a VOTF Complete if the VID reaches target VID.

T7 : The PWROK pin goes low and the SVI2 interface stops running. All output voltages go back to the boot VID in CCM.

T8 : The PWROK pin goes high again and the SVI2 interface starts running. The RT8877C waits for SVID command from processor.

T9 : A valid SVID command transaction occurs between the processor and the RT8877C.

T10 : The RT8877C starts VID-on-the-fly transition according to the received SVID command and send a VOTF Complete if the VID reaches target VID.

T11 : The enable signal goes low and all output voltages enter soft-shutdown mode.

Power Down Sequence

If the voltage at EN pin falls below the enable falling threshold, the controller is disabled. The voltage at the PGOOD and PGOODA pin will immediately go low at the loss of enable signal at the EN pin and the controller executes soft-shutdown operation. The internal digital circuit ramps down the reference voltage at the same slew rate as that of in soft-start, making VDD and VDDNB output voltages gradually decrease in CCM. Each of the controller channels stops switching when the voltage at the voltage sense pin V_{SEN}/V_{SENA} , cross about 0.2V. The Boot VID information stored in the internal register is cleared at POR. This event forces the RT8877C to check the SVC and SVD inputs for a new boot VID when the EN voltage goes high again.

PGOOD and PGOODA

The PGOOD and PGOODA are open-drain logic outputs. The 2 pins provide the power good signal when VDD and VDDNB output voltage are within the regulation limits and no protection is triggered. These pins are typically tied to 3.3V or 5V power source through a pull-high resistor. During shutdown state (EN = low) and the soft-start period, the PGOOD and PGOODA voltages are pulled low. After a successful soft-start and VDD and VDDNB output voltages are within the regulation limits, the PGOOD and PGOODA are released high individually.

The voltages at the PGOOD pin and PGOODA pin are pulled low individually during normal operation when any of the following events occurs: over voltage protection, under voltage protection, over current protection, and logic low EN voltage. If one rail triggers protection, another rail's PGOOD will be pull low after 5 μ s delay.

SVI2 Wire Protocol

The RT8877C complies with AMD's Voltage Regulator Specification, which defines the Serial VID Interface 2 (SVI2) protocol. With SVI2 protocol, the processor directly controls the reference voltage level of each individual controller channel and determines which controller operates in power saving mode. The SVI2 interface is a three wire bus that connects a single master to one or above slaves. The master initiates and terminates SVI2 transactions and drives the clock, SVC, and the data, SVD, during a transaction. The slave drives the telemetry, SVT during a transaction. The AMD processor is always the master. The voltage regulator controller (RT8877C) is always the slave. The RT8877C receives the SVID code and acts accordingly. The SVI protocol supports 20MHz high speed mode I²C, which is based on SVD data packet. Table 7 shows the SVD data packet. A SVD packet consists of a "Start" signal, three data bytes after each byte, and a "Stop" signal. The 8-bit serial VID codes are listed in Table 1. After the RT8877C has received the stop sequence, it decodes the received serial VID code and executes the command. The controller has the ability to sample and report voltage and current for the VDD and VDDNB domains. The controller reports this telemetry serially over the SVT wire which is clocked by the processor driven SVC. A bit TFN at SVD packet along with the VDD and VDDNB domain selector bits are used by the processor to change the telemetry functionality. The telemetry bit definition is listed in Figure 4. The detailed SVI2 specification is outlined in the AMD Voltage Regulator and Voltage Regulator Module (VRM) and Serial VID Interface 2.0 (SVI2) Specification.

Table 7. SVD Data Packet

Bit Time	Description
1 : 5	Always 11000b
6	VDD domain selector bit, if set then the following two data bytes contain the VID for VDD, the PSI state for VDD, and the load line slope trim and offset trim state for VDD.
7	VDDNB domain selector bit, if set then the following two data bytes contain the VID for VDDNB, the PSI state for VDDNB, and the load line slope trim and offset trim state for VDDNB.
8	Always 0b
10	PSIO_L
11 : 17	VID Code bits [7:1]
19	VID Code bit [0]

Bit Time	Description
20	PSI1_L
21	TFN (Telemetry Functionality)
22 : 24	Load Line Slope Trim [2:0]
25 : 26	Offset Trim [1:0]

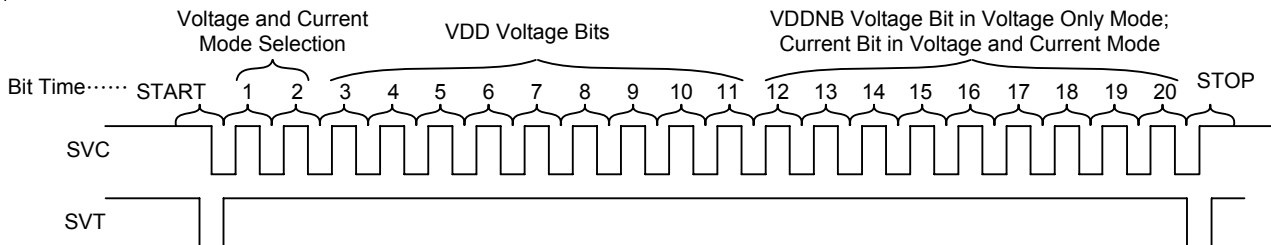

Figure 4. Telemetry Bit Definition

PWROK and SVI2 Operation

The PWROK pin is an input pin, which is connected to the global power good signal from the platform. Logic high at this pin enables the SVI2 interface, allowing data transaction between processor and the RT8877C. Once the RT8877C receives a valid SVID code, it decodes the information from processor to determine which output plane is going to move to the target VID. The internal DAC then steps the reference voltage in a controlled slew rate, making the output voltage shift to the required new VID. Depending on the SVID code, more than one controller channels can be targeted simultaneously in the VID transition. For example, VDD and VDDNB voltages can ramp up/down at the same time.

If the PWROK input goes low during normal operation, the SVI2 protocol stops running. The RT8877C immediately drives SVT high and modifies all output voltages back to the boot VID, which is stored in the internal register right after the controller is enabled. The controller does not read SVD and SVC inputs after the loss of PWROK. If the PWROK input goes high again, the SVI2 protocol resumes running. The RT8877C then waits to decode the SVID command from processor for a new VID and acts as previously described. The SVI2 protocol is only running when the PWROK input goes high after the voltage at the EN pin goes high; otherwise, the RT8877C will not soft-start due to incorrect signal sequence.

VID-on-the-Fly Transition

After the RT8877C has received a valid SVID code, it enters CCM mode and executes the VID-on-the-fly transition by stepping up/down the reference voltage of the required controller channel(s) in a controlled slew rate, hence allowing the output voltage(s) to ramp up/down to the target VID. The output voltage slew rate during the VID-on-the-fly transition is faster than that in a soft-start/soft-shutdown operation. If the new VID level is higher than the current VID level, the controller begins stepping up the reference voltage with a typical slew rate of 12.5mV/μs upward to the target VID level. If the new level is lower than the current VID level, the controller begins stepping down the reference voltage with a typical slew rate of -12.5mV/μs downward to the target VID level.

During the VID-on-the-fly transition, the RT8877C will force the controller channel to operate in CCM mode. If the controller channel operates in the power-saving mode prior to the VID-on-the-fly transition, it will be in CCM mode during the transition and then back to the power saving mode at the end of the transition. The voltage at the PGOOD pin and PGOODA pin will keep high during the VID-on-the-fly transition. The RT8877C checks the output voltage for voltage-related protections and send a VOTF complete at the end of VID-on-the-fly transition. In the event of receiving a VID off code, the RT8877C steps the reference voltage of required controller channel down to zero, hence making the required output voltage decrease to zero. The voltage at the PGOOD pin and PGOODA pin will remain high since the VID code is valid.

Operation Mode Transition

The RT8877C supports operation mode transition function in VDD and VDDNB controller for the PSI[x]_L and command from AMD processor. Referring to Table 7, the PSI[x]_L bit in the SVI2 protocol controls the operating mode of the RT8877C controller channels. The default operation mode of VDD and VDDNB controller is CCM. When the VDD controller is in full-phase configuration and receives PSI0_L = 0 and PSI1_L = 1, the VDD controller will keep full-phase operation. When the VDD controller receives PSI0_L = 0 and PSI1_L = 0, the VDD controller takes phase shedding operation and enters diode emulation mode. In reverse, the VDD controller goes back to full-phase operation in CCM upon receiving PSI0_L = 1 and PSI1_L = 0 or 1, or PSI0_L = 0 and PSI1_L = 1. When the VDDNB controller receives PSI0_L = 0 and PSI1_L = 1, it enters single-phase CCM, when the VDDNB controller receives PSI0_L = 0 and PSI1_L = 0, it enters single-phase diode emulation mode. When the VDDNB controller goes back to full-phase CCM operation after receiving PSI0_L = 1 and PSI1_L = 0 or 1.

Differential Remote Sense Setting

The VDD and VDDNB controllers have differential, remote-sense inputs to eliminate the effects of voltage drops along the PC board traces, processor internal power routes and socket contacts. The processor contains on-die sense pins, VDD_SENSE, VDDNB_SENSE and VSS_SENSE. Connect RGND to VSS_SENSE. For VDD controller, connect FB to VDD_SENSE with a resistor to build the negative input path of the error amplifier. Connect FB_NB to VDDNB_SENSE with a resistor using the same way in VDD controller. Connect VSS_SENSE to RGND using separate trace as shown in Figure 5. The precision reference voltages refer to RGND for accurate remote sensing.

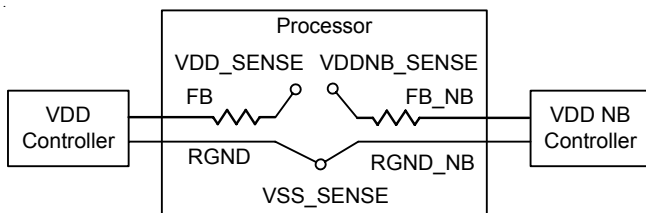

Figure 5. Differential Remote Voltage Sense Connection

SET1 and SET2 Pin Setting

The RT8877C provides SET1 pin for platform users to set the VDD and VDDNB controller OCP_TDC threshold and internal ramp amplitude (RSET & RSETA), SET2 pin to set VDD and VDDNB controller OCP trigger delay (OCPTRGDELAY) and quick response threshold (QRTH & QRTHA). To set these pin, platform designers should use resistive voltage divider on these pins, refer to Figure 6 and Figure 7. The voltage at SET1 and SET2 pin is

$$V_{SET1} = VCC \times \frac{R_{OCPTDC,D}}{R_{OCPTDC,U} + R_{OCPTDC,D}} \quad (1)$$

$$V_{SET2} = VCC \times \frac{R_{QRTH,D}}{R_{QRTH,U} + R_{QRTH,D}} \quad (2)$$

The ADC monitors and decodes the voltage at this pin only once after power up. After ADC decoding (only once), a 40µA current (when VCC = 5V) will be generated at the SET1 and SET2 pin for internal use. That is the voltage at SET1 and SET2 pin is

$$\Delta V_{SET1} = 40\mu A \times \frac{R_{OCPTDC,U} \times R_{OCPTDC,D}}{R_{OCPTDC,U} + R_{OCPTDC,D}} \quad (3)$$

$$\Delta V_{SET2} = 40\mu A \times \frac{R_{QRTH,U} \times R_{QRTH,D}}{R_{QRTH,U} + R_{QRTH,D}} \quad (4)$$

From equation (1) to equation (4) and Table 2 to Table 5, platform users can set the OCP_TDC threshold, OCP trigger delay, internal ramp amplitude and quick response threshold for VDD and VDDNB controller.

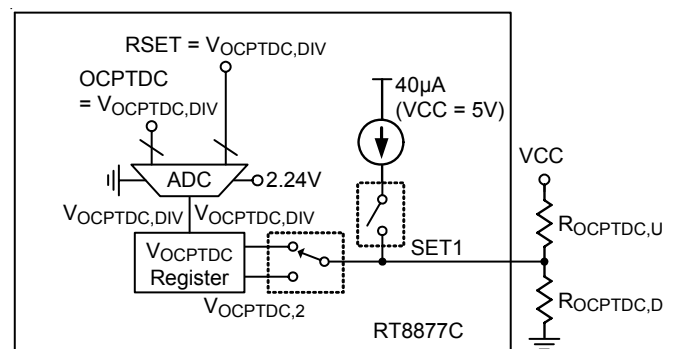

Figure 6. OCP_TDC/RSET Setting

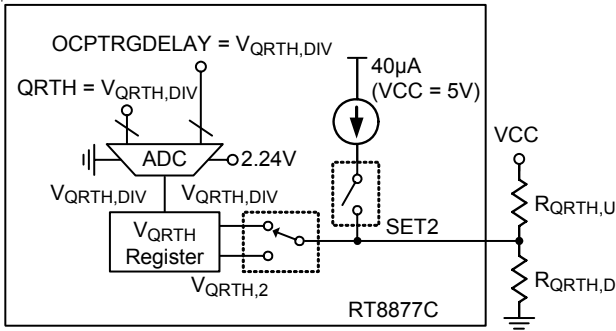

Figure 7. QRTH/OCPTRGDELAY Setting

VDD Controller

Active Phase Determination : Before POR

The number of active phases is determined by the internal circuitry that monitors the ISENxN voltages during start-up. Normally, the VDD controller operates as a 4-phase PWM controller. Pulling ISEN4N to VCC programs a 3-phase operation, pulling ISEN3N to VCC programs a 2-phase operation, and pulling ISEN2N to VCC programs a 1-phase operation. At EN rising edge, VDD controller detects whether the voltages of ISEN2N, ISEN3N and ISEN4N are higher than “VCC – 0.5V” respectively to decide how many phases should be active. Phase selection is only active during POR. When POR = high, the number of active phases is determined and latched. The unused ISENxP pins are recommended to be connected to VCC and unused PWM pins can be left floating.

Loop Control

The VDD controller adopts Richtek's proprietary G-NAVP™ topology. G-NAVP™ is based on the finite gain peak current mode with CCRCOT (Constant Current Ripple Constant On-Time) topology. The output voltage, V_{VDD} will decrease with increasing output load current. The control loop consists of PWM modulators with power stages, current sense amplifiers and an error amplifier as shown in Figure 8.

Similar to the peak current mode control with finite compensator gain, the HS_FET on-time is determined by CCRCOT on-time generator. When load current increases, V_{CS} increases, the steady state COMP voltage also increases and induces V_{VDD} to decrease, thus achieving

AVP. A near-DC offset canceling is added to the output of EA to eliminate the inherent output offset of finite gain peak current mode controller.

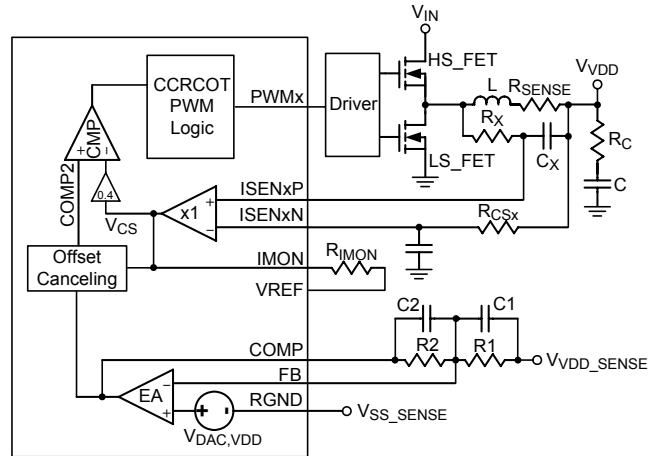

Figure 8. VDD Controller : Simplified Schematic for Droop and Remote Sense in CCM

Droop Setting

It's very easy to achieve Active Voltage Positioning (AVP) by properly setting the error amplifier gain due to the native droop characteristics as shown in Figure 9. This target is to have

$$V_{VDD} = V_{DAC, VDD} - I_{LOAD} \times R_{DROOP} \tag{5}$$

Then solving the switching condition $V_{COMP2} = V_{CS}$ in Figure 8 yields the desired error amplifier gain as

$$A_V = \frac{R_2}{R_1} = \frac{G_I}{R_{DROOP}} \tag{6}$$

$$G_I = \frac{R_{SENSE}}{R_{CSx}} \times R_{IMON} \times \frac{4}{10} \tag{7}$$

where G_I is the internal current sense amplifier gain. R_{SENSE} is the current sense resistor. If no external sense resistor present, it is the equivalent resistance of the inductor. R_{DROOP} is the equivalent load line resistance as well as the desired static output impedance.

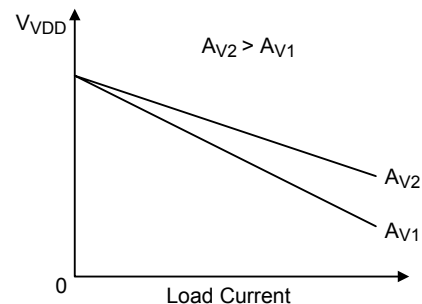

Figure 9. VDD Controller : Error Amplifier gain (AV) Influence on V_{VDD} Accuracy

Loop Compensation

Optimized compensation of the VDD controller allows for best possible load step response of the regulator's output. A type-I compensator with one pole and one zero is adequate for proper compensation. Figure 10 shows the compensation circuit. Previous design procedure shows how to select the resistive feedback components for the error amplifier gain. Next, C1 and C2 must be calculated for compensation. The target is to achieve constant resistive output impedance over the widest possible frequency range.

The pole frequency of the compensator must be set to compensate the output capacitor ESR zero :

$$f_p = \frac{1}{2\pi \times C \times R_C} \tag{8}$$

Where C is the capacitance of output capacitor, and R_C is the ESR of output capacitor. C2 can be calculated as follows :

$$C2 = \frac{C \times R_C}{R2} \tag{9}$$

The zero of compensator has to be placed at half of the switching frequency to filter the switching related noise. Such that,

$$C1 = \frac{1}{R1 \times \pi \times f_{SW}} \tag{10}$$

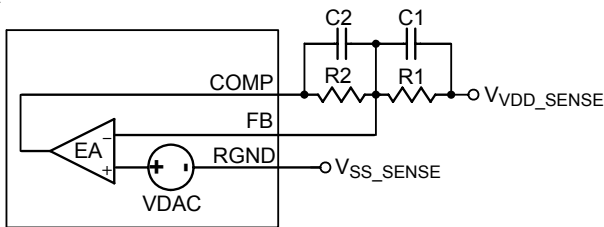

Figure 10. VDD Controller : Compensation Circuit

TON Setting

High frequency operation optimizes the application for the smaller component size, trading off efficiency due to higher switching losses. This may be acceptable in ultra portable devices where the load currents are lower and the controller is powered from a lower voltage supply. Low frequency operation offers the best overall efficiency at the expense of component size and board space. Figure 11 shows the On-Time setting Circuit. Connect a resistor (R_{TON}) between V_{IN} and TONSET to set the on-time of UGATE :

$$t_{ON} (0.5V \leq V_{DAC} < 1.8V) = \frac{24.4 \times 10^{-12} \times R_{TON}}{V_{IN} - V_{DAC}} \tag{11}$$

where t_{ON} is the UGATE turn on period, V_{IN} is Input voltage of the VDD controller, and V_{DAC} is the DAC voltage.

When V_{DAC} is larger than 1.8V, the equivalent switching frequency may be over 500kHz, and this too fast switching frequency is unacceptable. Therefore, the VDD controller implements a pseudo constant frequency technology to avoid this disadvantage of CCRCOT topology. When V_{DAC} is larger than 1.8V, the on-time equation will be modified to :

$$t_{ON} (V_{DAC} \geq 1.8V) = \frac{13.55 \times 10^{-12} \times R_{TON} \times V_{DAC}}{V_{IN} - V_{DAC}} \tag{12}$$

On-time translates only roughly to switching frequencies. The on-times guaranteed in the Electrical Characteristics are influenced by switching delays in external HS-FET. Also, the dead-time effect increases the effective on-time, which in turn reduces the switching frequency. It occurs only in CCM and during dynamic output voltage transitions.

When the inductor current reverses at light or negative load currents, with reversed inductor current, the phase goes high earlier than normal, extending the on-time by a period equal to the HS-FET rising dead time.

For better efficiency of the given load range, the maximum switching frequency is suggested to be :

$$f_{S(MAX)}(kHz) = \frac{1}{T_{ON} - T_{HS-Delay}} \times \frac{V_{DAC(MAX)} + I_{LOAD(MAX)} \times [R_{ON_LS-FET} + DCR_L - R_{DROOP}]}{V_{IN(MAX)} + I_{LOAD(MAX)} \times [R_{ON_LS-FET} - R_{ON_HS-FET}]} \tag{13}$$

Where f_{S(MAX)} is the maximum switching frequency, t_{HS-DELAY} is the turn-on delay of HS-FET, V_{DAC(MAX)} is the Maximum V_{DAC} of application, V_{IN(MAX)} is the Maximum application Input voltage, I_{LOAD(MAX)} is the maximum load of application, R_{ON_LS-FET} is the Low side FET R_{DS(ON)}, R_{ON_HS-FET} is the High side FET R_{DS(ON)}, DCR_L is the equivalent resistance of the inductor, and R_{DROOP} is the load line setting.

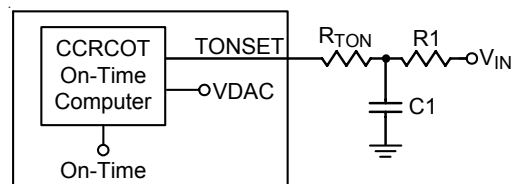

Figure 11. VDD Controller : On-Time Setting with R_C filter

Current Sense Setting

The current sense topology of the VDD controller is continuous inductor current sensing. Therefore, the controller has less noise sensitive. Low offset amplifiers are used for current balance, loop control and over current detection. The ISENxP and ISENxN pins denote the positive and negative input of the current sense amplifier of each phase.

Users can either use a current sense resistor or the inductor's DCR_L for current sensing. Using the inductor's DCR_L allows higher efficiency as shown in Figure 12.

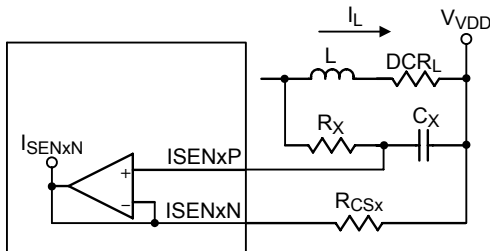

Figure 12. VDD Controller : Lossless Inductor Sensing

In order to optimize transient performance, R_X and C_X must be set according to the equation below :

$$\frac{L}{DCR_L} = R_X \times C_X \tag{14}$$

Then the proportion between the phase current, I_L, and the sensed current, I_{SENxN}, is driven by the value of the effective sense resistance, R_{CSx}, and the DCR_L of the inductor. The resistance value of R_{CSx} is limited by the internal circuitry. The recommended value is from 500Ω to 1.2kΩ.

$$I_{SENxN} = I_L \times \frac{DCR_L}{R_{CSx}} \tag{15}$$

Considering the inductance tolerance, the resistor R_X has to be tuned on board by examining the transient voltage. If the output voltage transient has an initial dip below the minimum load line requirement and the recovery is too fast causing a ring back. Vice versa, with a resistance too large the output voltage transient has only a small initial dip with a slow recovery.

Using current sense resistor in series with the inductor can have better accuracy, but the efficiency is a trade-off. Considering the equivalent inductance (L_{ESL}) of the current sense resistor, an RC filter is recommended. The RC filter calculation method is similar to the above mentioned inductor equivalent resistance sensing method.

Per-Phase Over Current Protection

The VDD controller provides over current protection in each phase. For VDD controller in four-phase configuration, either phase can trigger Per-Phase Over Current Protection (PHOCP).

The VDD controller senses each phase inductor current I_L, and PHOCP comparator compares sensed current with PHOCP threshold current, as shown in Figure 13.

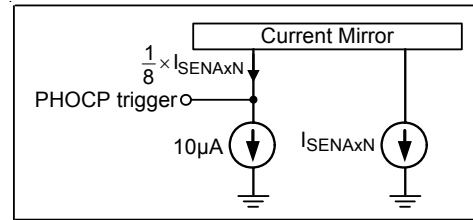

Figure 13. VDD Controller : Per-Phase OCP Setting

The resistor R_{CSx} determines PHOCP threshold.

$$I_{L,PERPHASE(MAX)} \times \frac{DCR_L}{R_{CSx}} \times \frac{1}{8} = 10\mu A \tag{16}$$

$$R_{CSx} = \frac{I_{L,PERPHASE(MAX)} \times DCR_L}{8 \times 10\mu A} \tag{17}$$

The controller will turn off all high side/low side MOSFETs to protect CPU if the per-phase over current protection is triggered.

Current Balance

The VDD controller implements internal current balance mechanism in the current loop. The VDD controller senses and compares per-phase current signal with average current. If the sensed current of any particular phase is larger than average current, the on-time of this phase will be adjusted to be shorter.

Initial Offset and External Offset (Over Clocking Offset Function)

The VDD controller features over clocking offset function which provides the possibility of wide range off set of output voltage. The initial offset function can be implemented through the SVI interface. When the OFS pin voltage < 0.3V at EN rising edge, the initial offset is disabled. The external offset function can be implemented by SET2 pin setting. For example, referring to Table 8, when the both rail external offset functions are enabled, the output voltage is :

$$V_{VDD} = V_{DAC} - I_{LOAD} \times R_{DROOP} + V_{External_OFS} + V_{Initial_OFS} \quad (18)$$

$V_{Initial_OFS}$ is the initial offset voltage set by SVI interface, and the external offset voltage, $V_{External_OFS}$ is set by supplying a voltage into OFS pin.

It can be calculated as below :

$$V_{External_OFS} = V_{OFS} - 1.2V \quad (19)$$

If supplying 1.3V at OFS pin , it will achieve 100mV offset at the output. Connecting a filter capacitor between the OFS pin and GND is necessary. Designers can design the offset slew rate by properly setting the filter bandwidth.

Table 8. External Offset Function Setting for VDD and VDDNB Controller

Core_OFFSET_EN	NB_OFFSET_EN	Description
0	0	Disable external offset function.
0	1	NB rail external offset is set by OFS pin voltage.
1	0	Core rail external offset is set by OFSA pin voltage.
1	1	Core rail external offset is set by OFS pin voltage, and NB rail external offset is set by OFSA pin voltage.

Dynamic VID Enhancement

During a dynamic VID event, the charging (dynamic VID up) or discharging (dynamic VID down) current causes unwanted load-line effect which degrades the settling time performance. The RT8877C will hold the inductor current to hold the load-line during a dynamic VID event. The VDD controller will always enter four-phase configuration when VDD controller receives dynamic VID up and VDD controller will hold the operating state when VDD controller receives dynamic VID down.

Ramp Amplitude Adjust

When the VDD controller takes phase shedding operation and enters diode emulation mode, the internal ramp of VDD controller will be modified for the reason of stability. In case of smooth transition into DEM, the CCM ramp amplitude should be designed properly. The RT8877C provides SET1 pin for platform users to set the ramp amplitude of the VDD controller in CCM.

Current Monitoring and Current Reporting

The VDD controller provides current monitoring function via inductor current sensing. In G-NAVP™ technology, the output voltage is dependent on output current, and the current monitoring function is achieved by this characteristic of output voltage. The equivalent output current will be sensed from inductor current sensing and mirrored to IMON pin. The resistor connected to IMON pin determines voltage of the IMON output.

$$V_{IMON} = I_{L,SUM} \times \frac{DCR_L}{R_{CSx}} \times R_{IMON} + 0.64 \quad (20)$$

Where I_L is the phase current, R_{CSx} is the effective sense resistance, and R_{IMON} is the current monitor current setting resistor. Note that the IMON pin cannot be monitored.

The ADC circuit of the VDD controller monitors the voltage variation at the IMON pin from 0V to 3.19375V, and this voltage is decoded into digital format and stored into Output_Current register. The ADC divides 3.19375V into 511 levels, so $LSB = 3.19375V / 511 = 6.25mV$.

Quick Response

The VDD controller utilizes a quick response feature to support heavy load current demand during instantaneous load transient. The VDD controller monitors the current of the V_{VDD_SENSE} , and this current is mirrored to internal quick response circuit. At steady state, this mirrored current will not trigger a quick response. When the V_{VDD_SENSE} voltage drops abruptly due to load apply transient, the mirrored current flowing into quick response circuit will also increase instantaneously.

The QR threshold setting for VDD controller refers to Table 4.

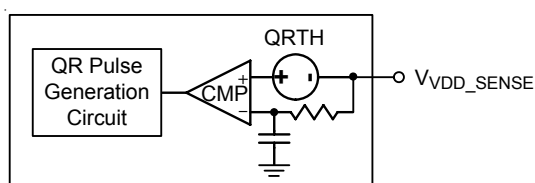

Figure 14. VDD Controller : Quick Response Triggering Circuit

When quick response is triggered, the quick response circuit will generate a quick response pulse. The pulse width of quick response is almost the same with t_{ON} .

After generating a quick response pulse, the pulse is then applied to the on-time generating circuit, and all the active phases' on-time will be overridden by the quick response pulse.

Over Current Protection

The RT8877C has dual OCP mechanism. The dual OCP mechanism has two types of thresholds. The first type, referred to as OCP-TDC, is a time and current based threshold. OCP-TDC should trip when the average output current exceeds TDC by some percentage and for a period of time. This period of time is referred to as the trigger delay. The second type, referred to as OCP-SPIKE, is a current based threshold. OCP-SPIKE should trip when the cycle-by-cycle output current exceeds IDDSPIKE by some percentage. If either mechanism trips, then the VDD controller asserts OCP_L and delays any further action. This delay is called an action delay. Refer to action delay time. After the action delay has expired and the VDD controller has allowed its current sense filter to settle out and the current has not decreased below the threshold, then the VDD controller will turn off both high side MOSFETs and low side MOSFETs of all channels.

Users can set OCP-SPIKE threshold, $I_{L,SUM(SPIKE)}$, by the current monitor resistor R_{IMON} of the following equation :

$$I_{L,SUM(SPIKE)} = \frac{3.19375 - 0.64}{DCR_L} \times \frac{R_{CSx}}{R_{IMON}} \quad (21)$$

And set the OCP-TDC threshold, $I_{L(TDC)}$, refer to some percentage of OCP-SPIKE through Table 2.

Over Voltage Protection (OVP)

The over voltage protection circuit of the VDD controller monitors the output voltage via the V_{SEN} pin after POR. When VID is lower than 0.9V, once V_{SEN} exceeds "0.9V + 325mV", OVP is triggered and latched. When VID is larger than 0.9V, once V_{SEN} exceeds the internal reference by 325mV, OVP is triggered and latched. The VDD controller will try to turn on low side MOSFETs and turn off high side MOSFETs of all active phases of the VDD controller to protect the CPU. When OVP is triggered by one rail, the other rail will also enter soft shut down sequence. A 1 μ s delay is used in OVP detection circuit to prevent false trigger.

Negative Voltage Protection (NVP)

During OVP latch state, the VDD controller also monitors the V_{SEN} pin for negative voltage protection. Since the OVP latch continuously turns on all low side MOSFETs of the VDD controller, the VDD controller may suffer negative output voltage. As a consequence, when the V_{SEN} voltage drops below 0V after triggering OVP, the VDD controller will trigger NVP to turn off all low side MOSFETs of the VDD controller while the high side MOSFETs remains off. After triggering NVP, if the output voltage rises above 0V, the OVP latch will restart to turn on all low side MOSFETs. The NVP function will be active only after OVP is triggered.

Under Voltage Protection (UVP)

The VDD controller implements under voltage protection of $V_{OUT,VDD}$. If V_{SEN} is less than the internal reference by 325mV, the VDD controller will trigger UVP latch. The UVP latch will turn off both high side and low side MOSFETs. When UVP is triggered by one rail, the other rail will also enter soft shut down sequence. A 3 μ s delay is used in UVP detection circuit to prevent false trigger.

Under Voltage Lock Out (UVLO)

During normal operation, if the voltage at the VCC or DVD pin drops below POR threshold, the VDD controller will trigger UVLO. The UVLO protection forces all high side MOSFETs and low side MOSFETs off by shutting down internal PWM logic drivers. A 3 μ s delay is used in UVLO detection circuit to prevent false trigger.

VDDNB Controller

VDDNB Controller Disable

The VDDNB controller can be disabled by connecting ISENA1N to a voltage higher than VCC. If not in use, ISENAxP is recommended to be connected to VCC, while PWMMax is left floating. When VDDNB controller is disabled, all SVID commands related to VDDNB controller will be rejected.

Loop Control

The VDDNB controller adopts Richtek's proprietary G-NAVP™ topology. G-NAVP™ is based on the finite gain peak current mode with CCRCOT (Constant Current Ripple

Constant On-Time) topology. The output voltage, V_{VDDNB} will decrease with increasing output load current. The control loop consists of PWM modulators with power stages, current sense amplifiers and an error amplifier as shown in Figure 15.

Similar to the peak current mode control with finite compensator gain, the HS_FET on-time is determined by CCRCOT on-time generator. When load current increases, V_{CS} increases, the steady state COMPA voltage also increases and induces V_{VDDNB} to decrease, thus achieving AVP. A near-DC offset canceling is added to the output of EA to eliminate the inherent output offset of finite gain peak current mode controller.

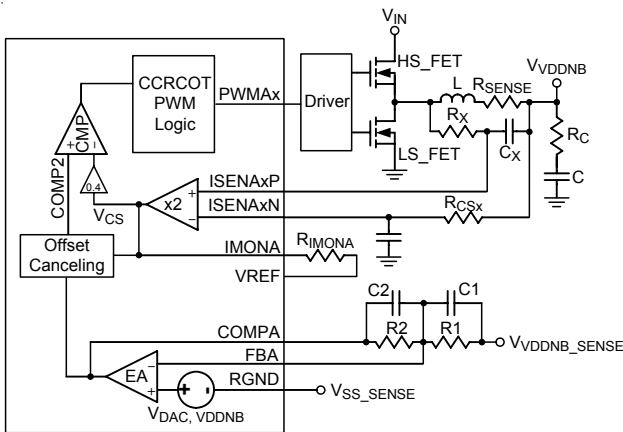

Figure 15. VDDNB Controller : Simplified Schematic for Droop and Remote Sense in CCM

Droop Setting

It's very easy to achieve Active Voltage Positioning (AVP) by properly setting the error amplifier gain due to the native droop characteristics as shown in Figure 16. This target is to have

$$V_{VDDNB} = V_{DAC,VDDNB} - I_{LOAD} \times R_{DROOP} \tag{22}$$

Then solving the switching condition $V_{COMP2} = V_{CS}$ in Figure 17 yields the desired error amplifier gain as

$$A_V = \frac{R_2}{R_1} = \frac{G_1}{R_{DROOP}} \tag{23}$$

$$\text{where } G_1 = \frac{R_{SENSE}}{R_{CSx}} \times R_{IMON} \times \frac{8}{10} \tag{24}$$

where G_1 is the internal current sense amplifier gain. R_{SENSE} is the current sense resistor. If no external sense resistor present, it is the equivalent resistance of the inductor. R_{DROOP} is the equivalent load line resistance as well as the desired static output impedance.

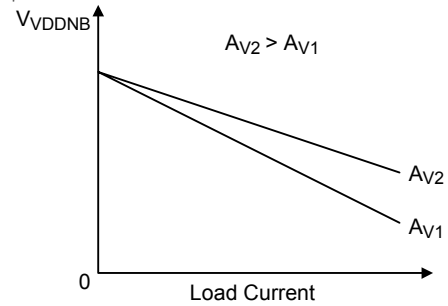

Figure 16. VDDNB Controller : Error Amplifier gain (A_V) Influence on V_{VDDNB} Accuracy

Loop Compensation

Optimized compensation of the VDDNB controller allows for best possible load step response of the regulator's output. A type-I compensator with one pole and one zero is adequate for proper compensation. Figure 17 shows the compensation circuit. Previous design procedure shows how to select the resistive feedback components for the error amplifier gain. Next, C_1 and C_2 must be calculated for compensation. The target is to achieve constant resistive output impedance over the widest possible frequency range.

The pole frequency of the compensator must be set to compensate the output capacitor ESR zero :

$$f_p = \frac{1}{2\pi \times C \times R_C} \tag{25}$$

Where C is the capacitance of output capacitor, and R_C is the ESR of output capacitor. C_2 can be calculated as follows :

$$C_2 = \frac{C \times R_C}{R_2} \tag{26}$$

The zero of compensator has to be placed at half of the switching frequency to filter the switching related noise. Such that,

$$C_1 = \frac{1}{R_1 \times \pi \times f_{SW}} \tag{27}$$

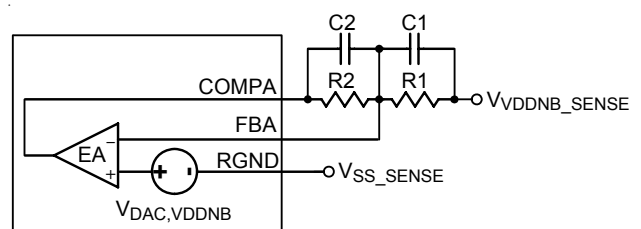

Figure 17. VDDNB Controller : Compensation Circuit

TON Setting

High frequency operation optimizes the application for the smaller component size, trading off efficiency due to higher switching losses. This may be acceptable in ultra portable devices where the load currents are lower and the controller is powered from a lower voltage supply. Low frequency operation offers the best overall efficiency at the expense of component size and board space. Figure 18 shows the On-Time setting Circuit. Connect a resistor (R_{TON}) between V_{IN} and TONSETA to set the on-time of UGATE :

$$t_{ON} (0.5V \leq V_{DAC} < 1.8V) = \frac{24.4 \times 10^{-12} \times R_{TON}}{V_{IN} - V_{DAC,VDDNB}} \quad (28)$$

where t_{ON} is the UGATE turn on period, V_{IN} is Input voltage of the VDDNB controller, and V_{DAC,VDDNB} is the DAC voltage.

When V_{DAC,VDDNB} is larger than 1.8V, the equivalent switching frequency may be over 500kHz, and this too fast switching frequency is unacceptable. Therefore, the VDDNB controller implements a pseudo constant frequency technology to avoid this disadvantage of CCRCOT topology. When V_{DAC,VDDNB} is larger than 1.8V, the on-time equation will be modified to :

$$t_{ON} (V_{DAC} \geq 1.8V) = \frac{13.55 \times 10^{-12} \times R_{TON} \times V_{DAC,VDDNB}}{V_{IN} - V_{DAC,VDDNB}} \quad (29)$$

On-time translates only roughly to switching frequencies. The on-times guaranteed in the Electrical Characteristics are influenced by switching delays in external HS-FET. Also, the dead-time effect increases the effective on-time, which in turn reduces the switching frequency. It occurs only in CCM and during dynamic output voltage transitions. When the inductor current reverses at light or negative load currents, with reversed inductor current, the phase goes high earlier than normal, extending the on-time by a period equal to the HS-FET rising dead time.

For better efficiency of the given load range, the maximum switching frequency is suggested to be :

$$f_{S(MAX)}(kHz) = \frac{1}{T_{ON} - T_{HS-Delay}} \times \frac{V_{DAC(MAX)} + I_{LOAD(MAX)} \times [R_{ON_LS-FET} + DCR_L - R_{DROOP}]}{V_{IN(MAX)} + I_{LOAD(MAX)} \times [R_{ON_LS-FET} - R_{ON_HS-FET}]} \quad (30)$$

Where f_{S(MAX)} is the maximum switching frequency, t_{HS-DELAY} is the turn-on delay of HS-FET, V_{DAC(MAX)} is the Maximum V_{DAC,VDDNB} of application, V_{IN(MAX)} is the Maximum application Input voltage, I_{LOAD(MAX)} is the maximum load of application, R_{ON_LS-FET} is the Low side FET R_{DS(ON)}, R_{ON_HS-FET} is the High side FET R_{DS(ON)}, DCR_L is the equivalent resistance of the inductor, and R_{DROOP} is the load line setting.

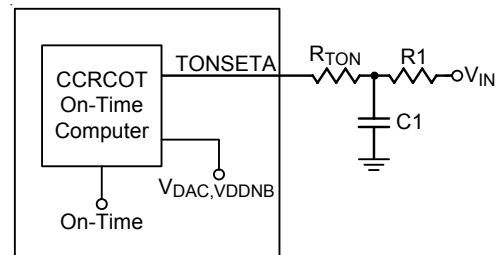

Figure 18. VDDNB Controller : On-Time Setting with R_C Filter

Current Sense Setting

The current sense topology of the VDDNB controller is continuous inductor current sensing. Therefore, the controller has less sensitive noise. Low offset amplifiers are used for current balance, loop control and over current detection. The ISENAXP and ISENAXN pins denote the positive and negative input of the current sense amplifier of each phase.

Users can either use a current sense resistor or the inductor's DCR_L for current sensing. Using the inductor's DCR_L allows higher efficiency as shown in Figure 19.

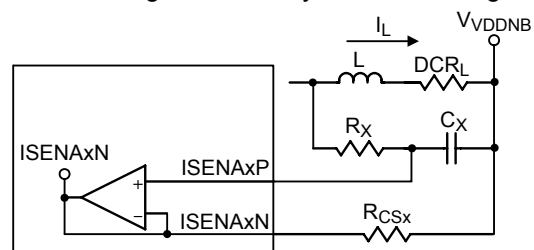

Figure 19. VDDNB Controller : Lossless Inductor Sensing

In order to optimize transient performance, R_X and C_X must be set according to the equation below :

$$\frac{L}{DCR_L} = R_X \times C_X \quad (31)$$

Then the proportion between the phase current, I_L, and the sensed current, I_{SENAXN}, is driven by the value of the effective sense resistance, R_{CSX}, and the DCR_L of the

inductor. The resistance value of R_{CSx} is limited by the internal circuitry. The recommended value is from 500Ω to $1.2k\Omega$.

$$I_{SENAXN} = I_L \times \frac{DCR_L}{R_{CSx}} \quad (32)$$

Considering the inductance tolerance, the resistor R_x has to be tuned on board by examining the transient voltage. If the output voltage transient has an initial dip below the minimum load line requirement and the recovery is too fast causing a ring back. Vice versa, with a resistance too large the output voltage transient has only a small initial dip with a slow recovery.

Using current sense resistor in series with the inductor can have better accuracy, but the efficiency is a trade-off. Considering the equivalent inductance (L_{ESL}) of the current sense resistor, an RC filter is recommended. The RC filter calculation method is similar to the above mentioned inductor equivalent resistance sensing method.

Per-Phase Over Current Protection

The VDDNB controller provides over current protection in each phase. For VDDNB controller in two-phase configuration, either phase can trigger Per-Phase Over Current Protection (PHOCP).

The VDDNB controller senses each phase inductor current I_L , and PHOCP comparator compares sensed current with PHOCP threshold current, as shown in Figure 20.

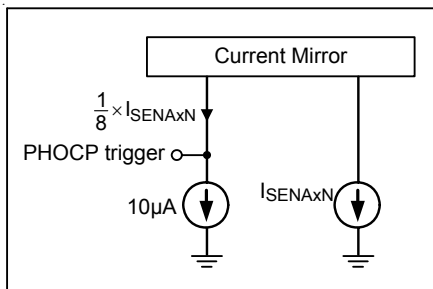

Figure 20. VDDNB Controller : Per-Phase OCP Setting

The resistor R_{CSx} determines PHOCP threshold.

$$I_{L,PERPHASE(MAX)} \times \frac{DCR_L}{R_{CSx}} \times \frac{1}{8} = 10\mu A \quad (33)$$

$$R_{CSx} = \frac{I_{L,PERPHASE(MAX)} \times DCR_L}{8 \times 10\mu A} \quad (34)$$

The controller will turn off all high side/low side MOSFETs to protect CPU if the per-phase over current protection is triggered.

Initial Offset and External Offset (Over Clocking Offset Function)

The VDDNB controller features over clocking offset function which provides the possibility of wide range offset of output voltage. The initial offset function can be implemented through the SVI interface. When the OFSA pin voltage $< 0.3V$ at EN rising edge, the initial offset is disabled.

The external offset function can be implemented by SET2 pin setting. For example, referring to Table 8, when the both rail external offset functions are enabled, the output voltage is :

$$V_{VDDNB} = V_{DAC,VDDNB} - I_{LOAD} \times R_{DROOP} + V_{External_OFSA} + V_{Initial_OFSA} \quad (35)$$

$V_{Initial_OFSA}$ is the initial offset voltage set by SVI interface, and the external offset voltage, $V_{External_OFSA}$ is set by supplying a voltage into OFSA pin.

It can be calculated as below :

$$V_{External_OFSA} = V_{OFSA} - 1.2V \quad (36)$$

If supplying $1.3V$ at OFSA pin, it will achieve $100mV$ offset at the output. Connecting a filter capacitor between the OFSA pin and GND is necessary. Designers can design the offset slew rate by properly setting the filter bandwidth.

Dynamic VID Enhancement

During a dynamic VID event, the charging (dynamic VID up) or discharging (dynamic VID down) current causes unwanted load-line effect which degrades the settling time performance. The RT8877C will hold the inductor current to hold the load-line during a dynamic VID event. The VDDNB controller will always enter two-phase configuration when VDDNB controller receives dynamic VID up and VDDNB controller will hold the operating state when VDDNB controller receives dynamic VID down.

Ramp Amplitude Adjust

When the VDDNB controller takes phase shedding operation and enters diode emulation mode, the internal ramp of VDDNB controller will be modified for the reason of stability. In case of smooth transition into DEM, the CCM ramp amplitude should be designed properly. The RT8877C provides SET1 pin for platform users to set the ramp amplitude of the VDDNB controller in CCM.

Current Monitoring and Current Reporting

The VDDNB controller provides current monitoring function via inductor current sensing. In G-NAVP™ technology, the output voltage is dependent on output current, and the current monitoring function is achieved by this characteristic of output voltage. The equivalent output current will be sensed from inductor current sensing and mirrored to IMONA pin. The resistor connected to IMONA pin determines voltage of the IMONA output.

$$V_{IMONA} = I_{L,SUM} \times 2 \times \frac{DCR_L}{R_{CSx}} \times R_{IMONA} + 0.64 \quad (37)$$

Where I_L is the phase current, R_{CSx} is the effective sense resistance, and R_{IMONA} is the current monitor current setting resistor. Note that the IMONA pin cannot be monitored.

The ADC circuit of the VDDNB controller monitors the voltage variation at the IMONA pin from 0V to 3.19375V, and this voltage is decoded into digital format and stored into Output_Current register. The ADC divides 3.19375V into 511 levels, so $LSB = 3.19375V / 511 = 6.25mV$.

Quick Response

The VDDNB controller utilizes a quick response feature to support heavy load current demand during instantaneous load transient. The VDDNB controller monitors the current of the V_{VDDNB_SENSE} , and this current is mirrored to internal quick response circuit. At steady state, this mirrored current will not trigger a quick response. When the V_{VDDNB_SENSE} voltage drops abruptly due to load apply transient, the mirrored current flowing into quick response circuit will also increase instantaneously.

The QR threshold setting for VDDNB controller refers to Table 5.

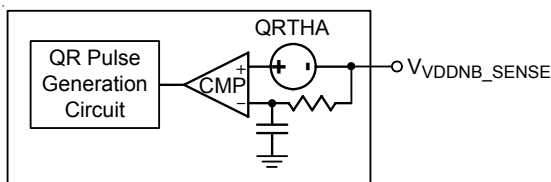

Figure 21. VDDNB Controller : Quick Response Triggering Circuit

When quick response is triggered, the quick response circuit will generate a quick response pulse. The pulse width of quick response is almost the same with t_{ON} .

After generating a quick response pulse, the pulse is then applied to the on-time generation circuit, and all the active phases' on-times will be overridden by the quick response pulse.

Over Current Protection

The RT8877C has dual OCP mechanism. The dual OCP mechanism has two types of thresholds. The first type, referred to as OCP-TDCA, is a time and current based threshold. OCP-TDCA should trip when the average output current exceeds TDCA by some percentage and for a period of time. This period of time is referred to as the trigger delay. The second type, referred to as OCP-SPIKEA, is a current based threshold. OCP-SPIKEA should trip when the cycle-by-cycle output current exceeds IDDSPIKEA by some percentage. If either mechanism trips, then the VDDNB controller asserts OCP_L and delays any further action. This delay is called an action delay. Refer to action delay time. After the action delay has expired and the VDDNB controller has allowed its current sense filter to settle out and the current has not decreased below the threshold, then the VDDNB controller will turn off both high side MOSFETs and low side MOSFETs of all channels.

Users can set OCP-SPIKEA threshold, $I_{L,SUM(SPIKEA)}$, by the current monitor resistor R_{IMONA} of the following equation :

$$I_{L,SUM(SPIKEA)} = \frac{3.19375 - 0.64}{2 \times DCR_L} \times \frac{R_{CSx}}{R_{IMONA}} \quad (38)$$

And set the OCP-TDCA threshold, $I_{L(TDCA)}$, refer to some percentage of OCP-SPIKEA through Table 3.

Over Voltage Protection (OVP)

The over voltage protection circuit of the VDDNB controller monitors the output voltage via the V_{SENA} pin after POR. When VID is lower than 0.9V, once V_{SENA} exceeds "0.9V + 325mV", OVP is triggered and latched. When VID is larger than 0.9V, once V_{SENA} exceeds the internal reference by 325mV, OVP is triggered and latched. The VDDNB controller will try to turn on low side MOSFETs and turn off high side MOSFETs of all active phases of the VDDNB controller to protect the CPU. When OVP is triggered by one rail, the other rail will also enter soft shut down sequence. A 1µs delay is used in OVP detection circuit to prevent false trigger.

Negative Voltage Protection (NVP)

During OVP latch state, the VDDNB controller also monitors the V_{SENA} pin for negative voltage protection. Since the OVP latch continuously turns on all low side MOSFETs of the VDDNB controller, the VDDNB controller may suffer negative output voltage. As a consequence, when the V_{SENA} voltage drops below 0V after triggering OVP, the VDDNB controller will trigger NVP to turn off all low side MOSFETs of the VDDNB controller while the high side MOSFETs remains off. After triggering NVP, if the output voltage rises above 0V, the OVP latch will restart to turn on all low side MOSFETs. The NVP function will be active only after OVP is triggered.

Under Voltage Protection (UVP)

The VDDNB controller implements under voltage protection of V_{OUT,VDDNB}. If V_{SENA} is less than the internal reference by 325mV, the VDDNB controller will trigger UVP latch. The UVP latch will turn off both high side and low side MOSFETs. When UVP is triggered by one rail, the other rail will also enter soft shut down sequence. A 3μs delay is used in UVP detection circuit to prevent false trigger.

Under Voltage Lock Out (UVLO)

During normal operation, if the voltage at the VCC or DVD pin drops below POR threshold, the VDDNB controller will trigger UVLO. The UVLO protection forces all high side MOSFETs and low side MOSFETs off by shutting down internal PWM logic drivers. A 3μs delay is used in UVLO detection circuit to prevent false trigger.

Thermal Considerations

For continuous operation, do not exceed absolute maximum junction temperature. The maximum power dissipation depends on the thermal resistance of the IC package, PCB layout, rate of surrounding airflow, and difference between junction and ambient temperature. The maximum power dissipation can be calculated by the following formula :

$$P_{D(MAX)} = (T_{J(MAX)} - T_A) / \theta_{JA}$$

where T_{J(MAX)} is the maximum junction temperature, T_A is the ambient temperature, and θ_{JA} is the junction to ambient thermal resistance.

For recommended operating condition specifications, the maximum junction temperature is 125°C. The junction to ambient thermal resistance, θ_{JA}, is layout dependent. For WQFN-52L 6x6 package, the thermal resistance, θ_{JA}, is 26.5°C/W on a standard JEDEC 51-7 four-layer thermal test board. The maximum power dissipation at T_A = 25°C can be calculated by the following formula :

$$P_{D(MAX)} = (125^{\circ}\text{C} - 25^{\circ}\text{C}) / (26.5^{\circ}\text{C}/\text{W}) = 3.77\text{W for WQFN-52L 6x6 package}$$

The maximum power dissipation depends on the operating ambient temperature for fixed T_{J(MAX)} and thermal resistance, θ_{JA}. The derating curve in Figure 22 allows the designer to see the effect of rising ambient temperature on the maximum power dissipation.

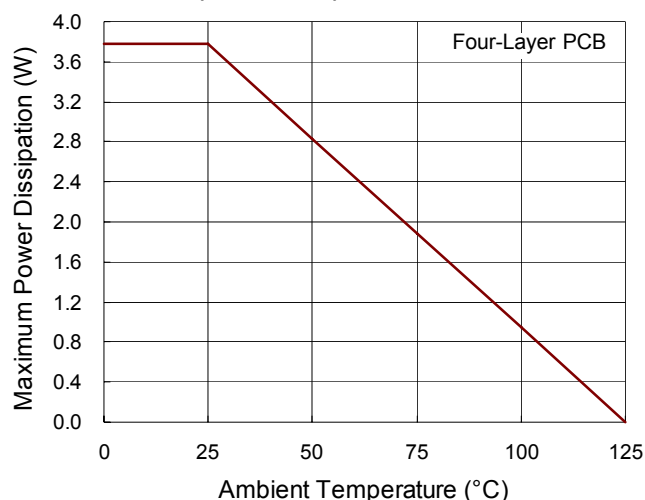
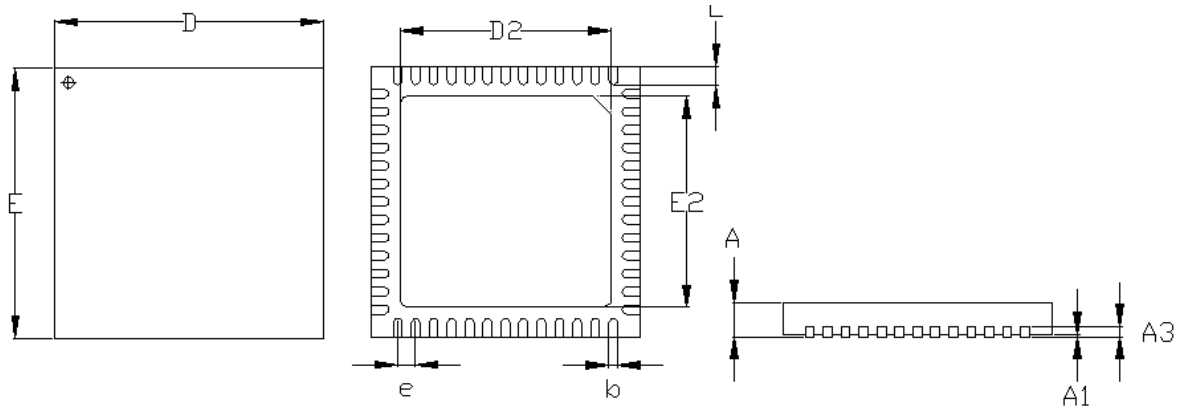

Figure 22. Derating Curve of Maximum Power Dissipation

Outline Dimension



Symbol	Dimensions In Millimeters		Dimensions In Inches	
	Min	Max	Min	Max
A	0.700	0.800	0.028	0.031
A1	0.000	0.050	0.000	0.002
A3	0.175	0.250	0.007	0.010
b	0.150	0.250	0.006	0.010
D	5.900	6.100	0.232	0.240
D2	4.650	4.750	0.183	0.187
E	5.900	6.100	0.232	0.240
E2	4.650	4.750	0.183	0.187
e	0.400		0.016	
L	0.350	0.450	0.014	0.018

W-Type 52L QFN 6x6 Package

Richtek Technology Corporation

5F, No. 20, Taiyuen Street, Chupei City
 Hsinchu, Taiwan, R.O.C.
 Tel: (8863)5526789

Richtek products are sold by description only. Richtek reserves the right to change the circuitry and/or specifications without notice at any time. Customers should obtain the latest relevant information and data sheets before placing orders and should verify that such information is current and complete. Richtek cannot assume responsibility for use of any circuitry other than circuitry entirely embodied in a Richtek product. Information furnished by Richtek is believed to be accurate and reliable. However, no responsibility is assumed by Richtek or its subsidiaries for its use; nor for any infringements of patents or other rights of third parties which may result from its use. No license is granted by implication or otherwise under any patent or patent rights of Richtek or its subsidiaries.