

3A, Ultra Low Dropout Regulator

General Description

The RT9035 is a high performance positive voltage regulator designed for use in applications requiring very low Input voltage and extremely low dropout voltage at up to 3A. It operates with a VIN as low as 1V and VDD voltage 3V with programmable output voltage as low as 0.8V. The RT9035 features ultra low dropout that is ideal for applications where VOUT is very close to VIN. Additionally, it has an enable pin to further reduce power dissipation while shutdown and provides excellent regulation over variations in line, load and temperature. The RT9035 provides a power good signal to indicate if the voltage level of VOUT reaches 90% of its rating value. The RT9035 is available in the WQFN-20L 4x4 package with 1.05V, 1.2V, 1.5V, 1.8V and 2.5V internally preset outputs that are also adjustable by using external resistors.

Ordering Information

RT9035-□□□□

- Package Type
QW : WQFN-20L 4x4 (W-Type)
- Lead Plating System
G : Green (Halogen Free and Pb Free)
Z : ECO (Ecological Element with Halogen Free and Pb free)
- Output Voltage
1K : 1.05V/Adj
12 : 1.2V/Adj
15 : 1.5V/Adj
18 : 1.8V/Adj
25 : 2.5V/Adj

Note :

Richtek products are :

- ▶ RoHS compliant and compatible with the current requirements of IPC/JEDEC J-STD-020.
- ▶ Suitable for use in SnPb or Pb-free soldering processes.

Features

- **Maximum 3A Low-Dropout Voltage Regulator**
- **High Accuracy Output Voltage 2%**
- **Dropout Voltage Typical 270mV at 3A**
- **Power Good Output**
- **Output Voltage Pull Low Resistance when Disable**
- **Thermal and Over Current Protection**
- **RoHS Compliant and Halogen Free**

Applications

- Note Book PC Applications
- Motherboard Applications

Pin Configurations

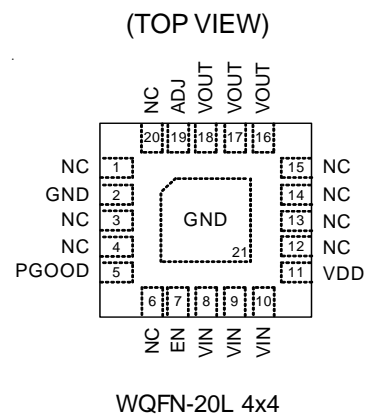

Marking Information

For marking information, contact our sales representative directly or through a Richtek distributor located in your area.

Typical Application Circuit

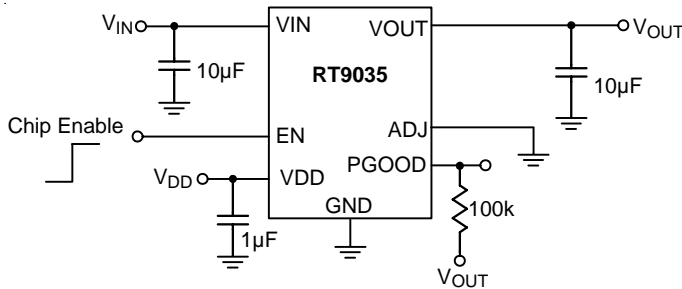

Figure 1. Fixed Voltage Regulator

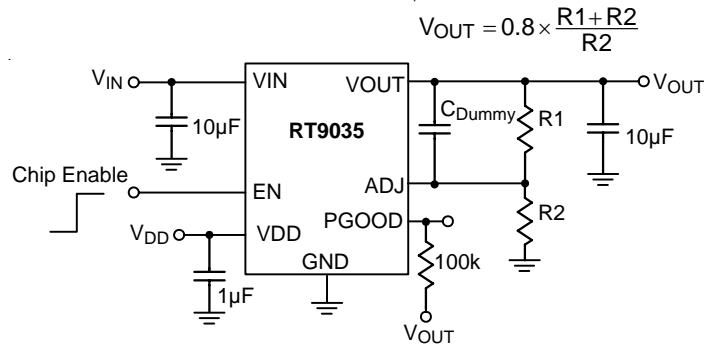
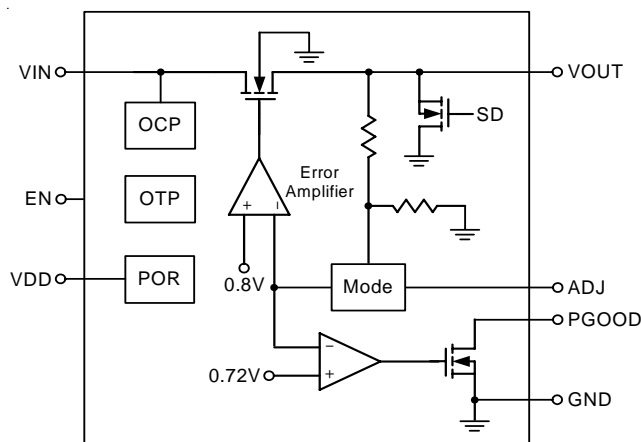

Figure 2. Adjustable Voltage Regulator

Functional Pin Description

Pin No.	Pin Name	Pin Function
1, 3, 4, 6, 12, 13, 14, 15, 20	NC	No Internal Connection.
2, 21 (Exposed Pad)	GND	Ground. The exposed pad must be soldered to a large PCB and connected to GND for maximum power dissipation.
5	PGOOD	Power Good Open Drain Output.
7	EN	Chip Enable (Active High). Internal pull low.
8, 9, 10	VIN	Supply Input Voltage.
11	VDD	Supply Voltage of Control Circuit.
16, 17, 18	VOUT	Output Voltage.
19	ADJ	Set the output voltage by an external feedback resistor divider. If the ADJ pin is grounded, the output voltage will be set by internal feedback resistor divider.

Function Block Diagram



Absolute Maximum Ratings (Note 1)

- Supply Input Voltage, V_{IN} ----- 6V
- Control Voltage ----- 6V
- Output Voltage ----- 6V
- Power Dissipation, P_D @ $T_A = 25^\circ\text{C}$
 WQFN-20L 4x4 ----- 1.852W
- Package Thermal Resistance (Note 2)
 WQFN-20L 4x4, θ_{JA} ----- 54°C/W
 WQFN-20L 4x4, θ_{JC} ----- 7°C/W
- Lead Temperature (Soldering, 10 sec.) ----- 260°C
- Junction Temperature ----- 150°C
- Storage Temperature Range ----- -65°C to 150°C
- ESD Susceptibility (Note 3)
 HBM (Human Body Mode) ----- 2kV
 MM (Machine Mode) ----- 200V

Recommended Operating Conditions (Note 4)

- Supply Input Voltage, V_{IN} ----- 1.5V to 5V
- Control Voltage, V_{DD} ----- 4.5V to 5.5V
- Junction Temperature Range ----- -40°C to 125°C
- Ambient Temperature Range ----- -40°C to 85°C

Electrical Characteristics

($V_{IN} = V_{OUT} + 500\text{mV}$, $V_{EN} = V_{DD} = 5\text{V}$, $C_{IN} = C_{OUT} = 10\mu\text{F}$, $T_A = 25^\circ\text{C}$, unless otherwise specified)

Parameter	Symbol	Test Conditions	Min	Typ	Max	Unit
VDD						
Quiescent Current (GND Current) (Note 5)	I_Q	$V_{DD} = 5\text{V}$	--	0.6	1.2	mA
VDD Operation Range	V_{DD}	V_{DD} Input Range	4.5	--	5.5	V
Power On Reset						
POR Threshold			2.4	2.7	3	V
POR Falling Hysteresis			0.15	0.2	--	V
VOUT						
Fixed Output Voltage		$V_{DD} = 5\text{V}$	-2	0	2	%
V_{OUT} Load Regulation (Note 6)	ΔV_{LOAD}	$V_{DD} = 5\text{V}$, $I_{OUT} = 3\text{A}$, $V_{IN} = V_{OUT} + 1\text{V}$	--	0.2	1	%
V_{OUT} Line Regulation (V_{IN})	ΔV_{LINE_IN}	$V_{DD} = 5\text{V}$, $V_{IN} = V_{OUT} + 1\text{V}$ to 5V $I_{OUT} = 1\text{mA}$	--	0.2	0.6	%
Dropout Voltage (Note 7)	V_{DROP}	$V_{DD} = 5\text{V}$, $I_{OUT} = 3\text{A}$	--	270	400	mV
Current Limit	I_{LIM}	$V_{DD} = 5\text{V}$, $V_{IN} = 3.6\text{V}$	--	4.5	--	A
Short Circuit Current		$V_{DD} = 5\text{V}$, $V_{OUT} < 0.2\text{V}$	--	2.5	--	A

To be Continued

Parameter	Symbol	Test Conditions	Min	Typ	Max	Unit	
In-rush Current		$V_{DD} = 5V$, $C_{OUT} = 10\mu F$, Enable Start-up, $I_{LOAD} = 1A$	--	0.5	--	A	
V_{OUT} Pull Low Resistance		$V_{EN} = 0V$	--	150	--	Ω	
ADJ							
Reference Voltage (Adj)		$V_{DD} = 5V$, $V_{OUT} = 2.5V$	0.788	0.8	0.812	V	
ADJ Pin Threshold			--	0.2	--	V	
Power Good							
Power Good Rising Threshold		$V_{DD} = 5V$	--	90	--	%	
Power Good Hysteresis		$V_{DD} = 5V$	--	10	--	%	
Power Good Sink Capability		$V_{DD} = 5V$, $I_{OUT} = 10mA$	--	0.2	0.4	V	
Chip Enable							
EN Threshold Voltage	Logic-Low	V_{EN_L}	$V_{DD} = 5V$	--	--	0.6	V
	Logic-High	V_{EN_H}	$V_{DD} = 5V$	1.2	--	--	
EN Pin Bias Current		I_{EN}	$V_{EN} = 5V$	--	12	--	μA
V_{DD} Shutdown Current		I_{SHDN}	$V_{DD} = 5V$, $V_{EN} = 0V$	--	--	1	μA
Over Temperature Protection							
Thermal Shutdown Temperature		T_{SD}	--	160	--	$^{\circ}C$	
Thermal Shutdown Returned Temperature			--	110	--	$^{\circ}C$	

Note 1. Stresses listed as the above "Absolute Maximum Ratings" may cause permanent damage to the device. These are for stress ratings. Functional operation of the device at these or any other conditions beyond those indicated in the operational sections of the specifications is not implied. Exposure to absolute maximum rating conditions for extended periods may remain possibility to affect device reliability.

Note 2. θ_{JA} is measured in the natural convection at $T_A = 25^{\circ}C$ on a high effective thermal conductivity test board (4 Layers, 2S2P) of JEDEC 51-7 thermal measurement standard. The case point of θ_{JC} is on the expose pad for WQFN package.

Note 3. Devices are ESD sensitive. Handling precaution is recommended.

Note 4. The device is not guaranteed to function outside its operating conditions.

Note 5. Quiescent, or ground current, is the difference between input and output currents. It is defined by $I_Q = I_{IN} - I_{OUT}$ under no load condition ($I_{OUT} = 0mA$).

Note 6. Regulation is measured at constant junction temperature by using a 2ms current pulse. Devices are tested for load regulation in the load range from 1mA to 3A.

Note 7. The dropout voltage is defined as $V_{IN} - V_{OUT}$, which is measured when V_{OUT} is $V_{OUT(NORMAL)} - 100mV$.

Typical Operating Characteristics

Load Transient Response

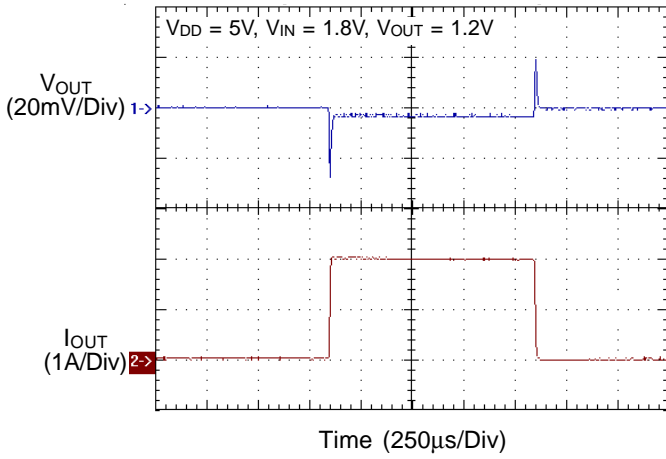

Load Transient Response

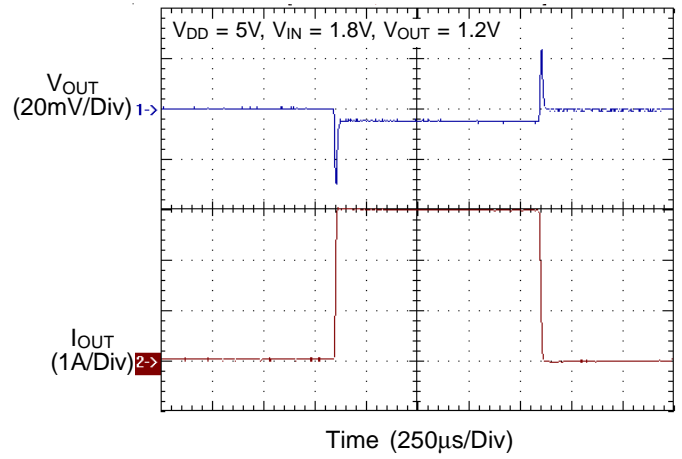

V_{DD} Line Transient Response

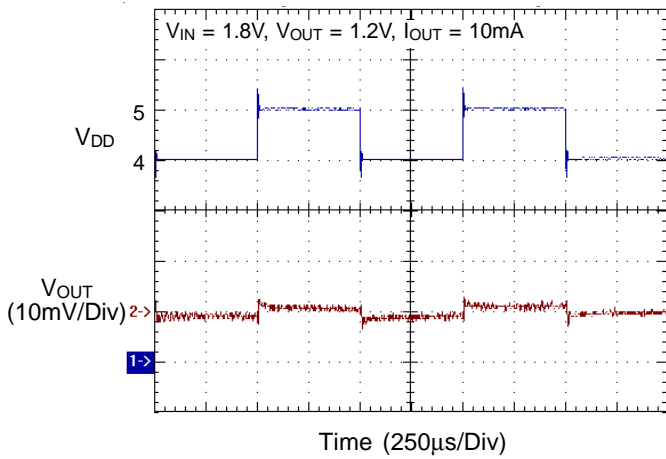

V_{DD} Line Transient Response

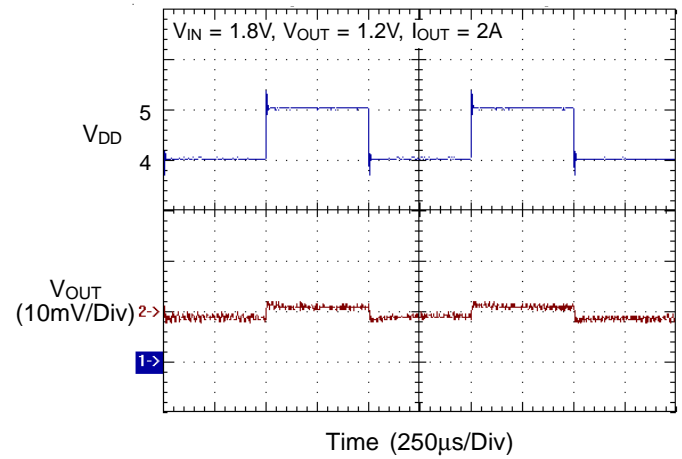

V_{IN} Line Transient Response

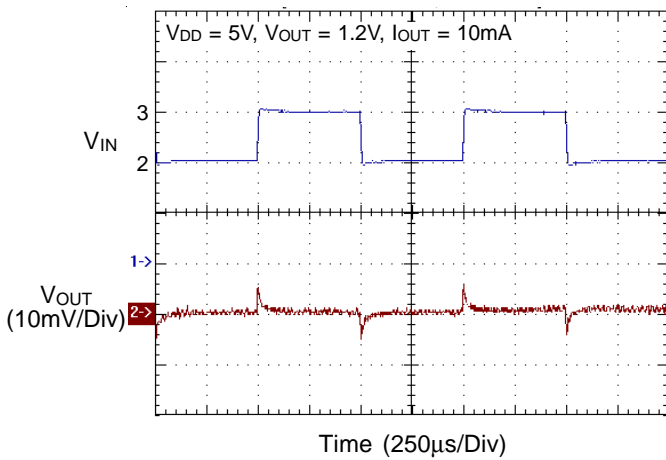

V_{IN} Line Transient Response

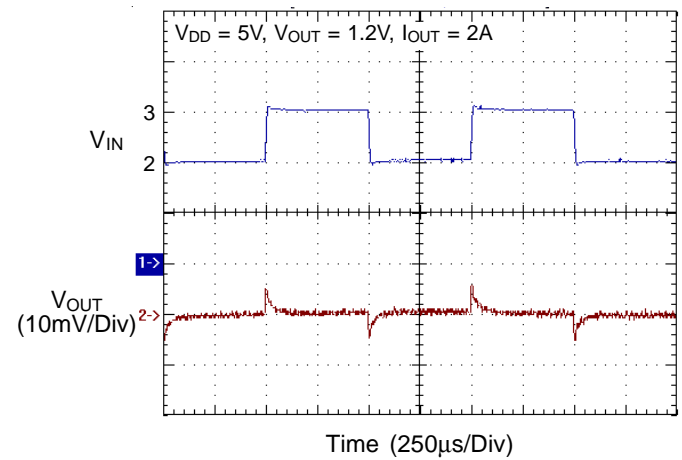

Dropout Voltage vs. Load Current

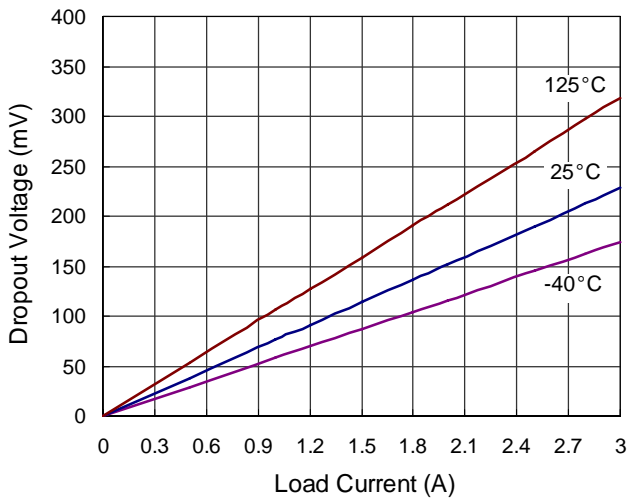

Start Up from Enable

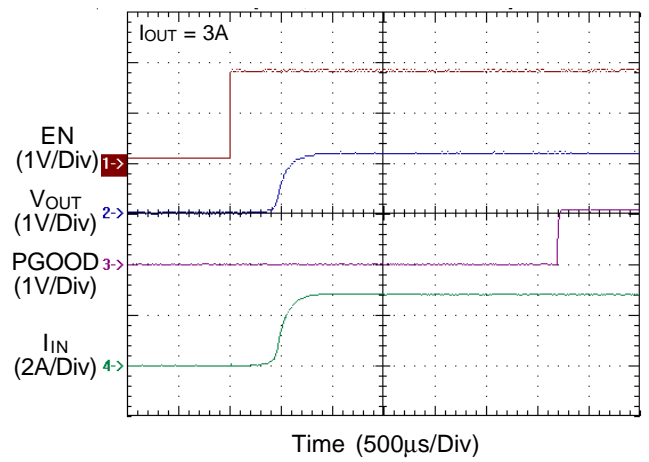

Start Up from VIN

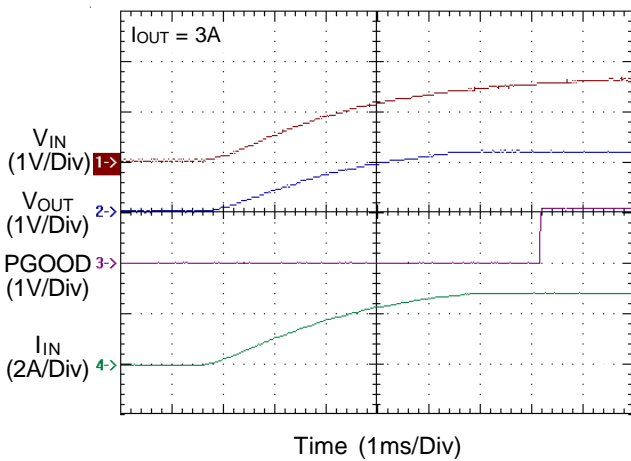

Start Up from VDD

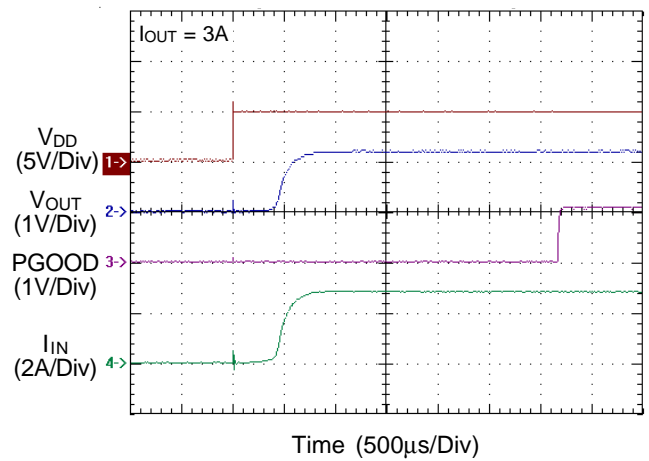

Short Circuit Protection

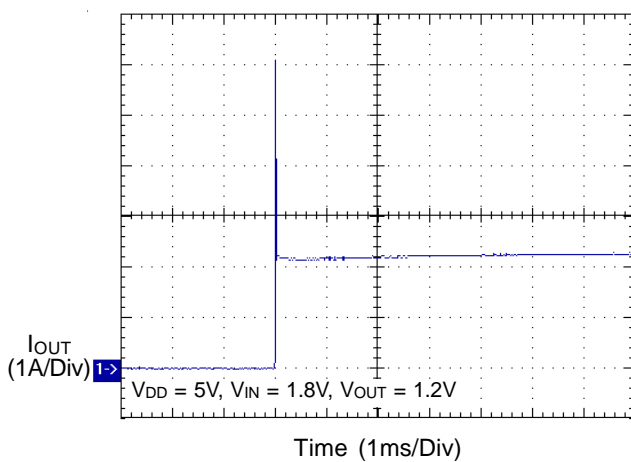

Short Current vs. Temperature

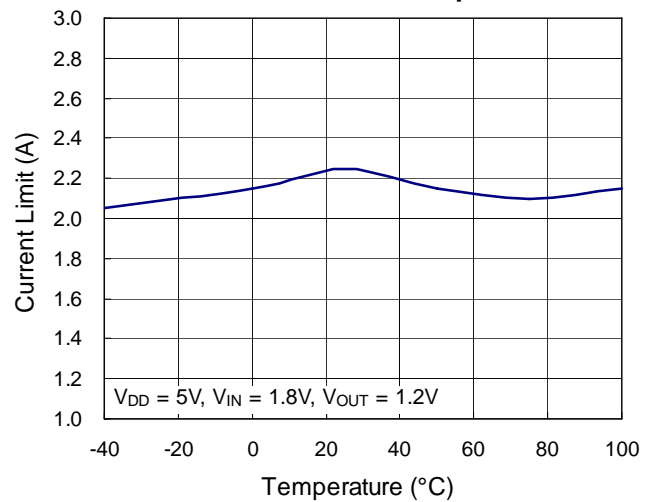

Current Limit vs. Temperature

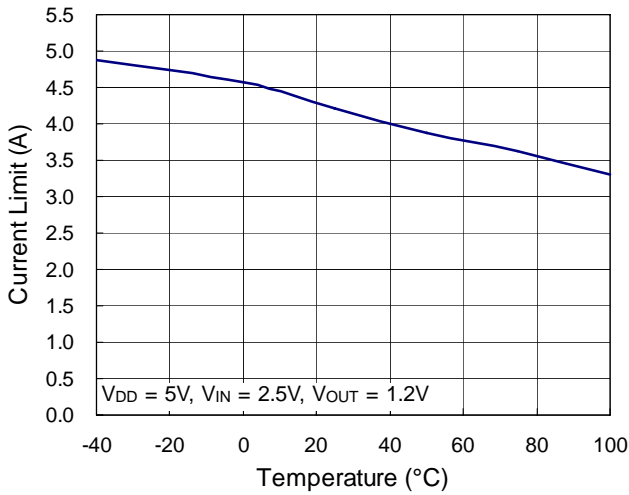

Quiescent Current vs. Temperature

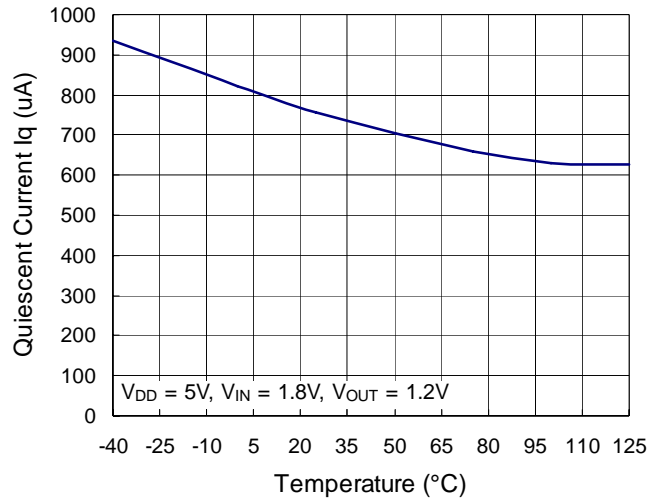

Reference Voltage vs. Temperature

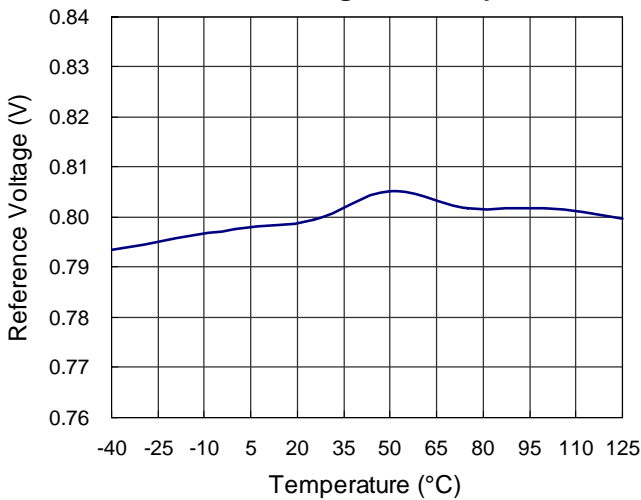

Output Voltage vs. Temperature

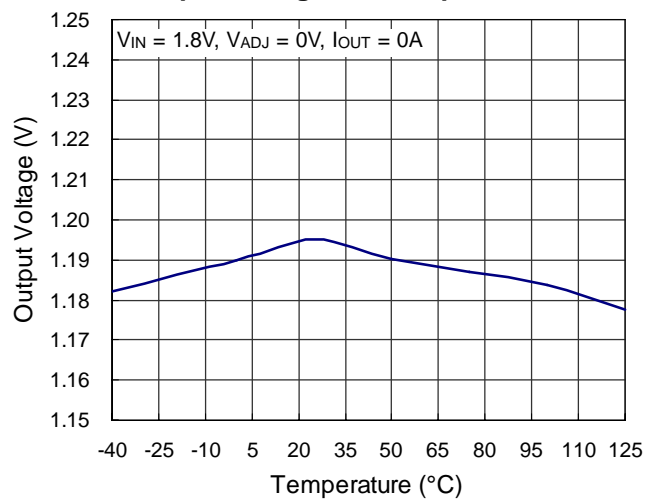

VDD POR Threshold Voltage vs. Temperature

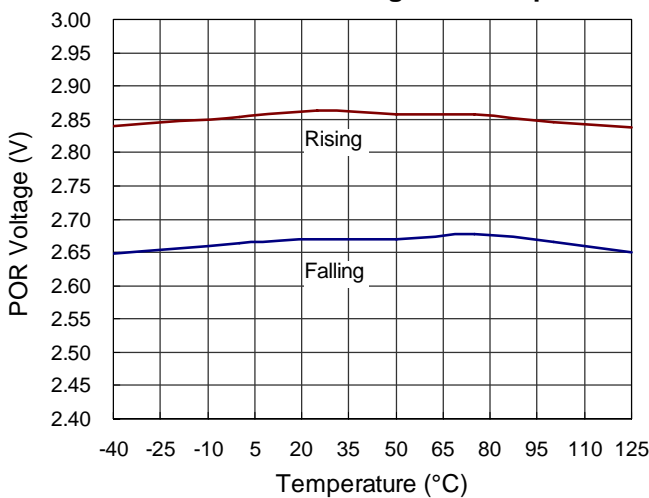

ADJ Threshold Voltage vs. Temperature

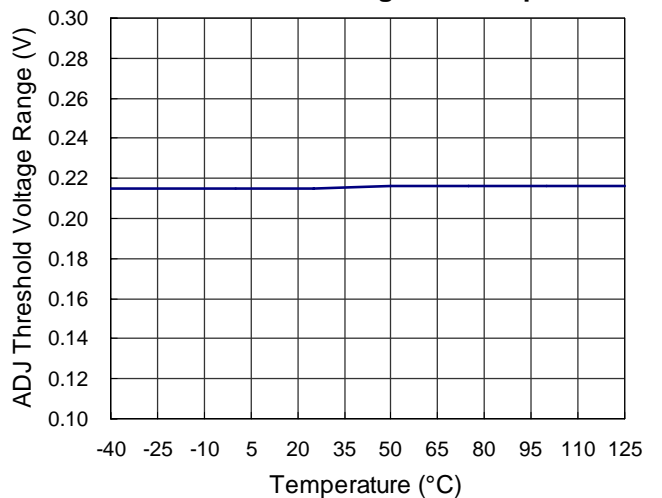

Application Information

Adjustable Mode Operation

The output voltage of RT9035 is adjustable from 0.8V to V_{IN} by external voltage divider resistors as shown in Typical Application Circuit (Figure 2). The value of resistors R1 and R2 should be more than 10k Ω to reduce the power loss.

Enable

The RT9035 goes into shutdown mode when the EN pin is in the logic low condition. During this condition, the pass transistor, error amplifier, and band gap are turned off. The RT9035 goes into operation mode when the EN pin is in the logic high condition. The RT9035 has an internal pull low resistor at EN pin so that the regulator will be turned off when EN pin is floating.

Output Capacitor

The RT9035 is specifically designed to employ ceramic output capacitors as low as 10 μ F. The ceramic capacitors offer significant cost and space savings, along with high frequency noise filtering.

Input Capacitor

Good bypassing is recommended from input to ground to help improve AC performance. A 10 μ F input capacitor or greater located as close as possible to the IC is recommended.

Current Limit

The RT9035 contains an independent current limit and the short circuit current protection to prevent unexpected applications. The current limit monitors and controls the pass transistor's gate voltage, limiting the output current to higher than 4.5A typical. When the output voltage is less than 0.2V, the short circuit current protection starts the current fold back function and maintains the loading current 2.5A. The output can be shorted to ground indefinitely without damaging the part.

Power Good

The power good function is an open-drain output. Connects 100k Ω pull up resistor to VOUT to obtain an output voltage.

The PGOOD pin will output high immediately after the output voltage arrives 90% of normal output voltage. The PGOOD pin will output high with typical 1.5ms delay time.

Thermal-Shutdown Protection

Thermal protection limits power dissipation to prevent IC over temperature in RT9035. When the operation junction temperature exceeds 160 $^{\circ}$ C, the over-temperature protection circuit starts the thermal shutdown function and turns the pass transistor off. The pass transistor turns on again after the junction temperature cools by 30 $^{\circ}$ C. RT9035 lowers its OTP trip level from 160 $^{\circ}$ C to 110 $^{\circ}$ C when output short circuit occurs ($V_{OUT} < 0.2V$). It limits IC case temperature under 100 $^{\circ}$ C and provides maximum safety to customer while output short circuit occurring.

Power Dissipation

For continuous operation, do not exceed absolute maximum operation junction temperature 125 $^{\circ}$ C. The power dissipation definition in device is:

$$P_D = (V_{IN} - V_{OUT}) \times I_{OUT} + V_{IN} \times I_Q$$

The maximum power dissipation depends on the thermal resistance of IC package, PCB layout, the rate of surroundings airflow and temperature difference between junctions to ambient. The maximum power dissipation can be calculated by following formula:

$$P_{D(MAX)} = (T_{J(MAX)} - T_A) / \theta_{JA}$$

Where $T_{J(MAX)}$ is the maximum operation junction temperature 125 $^{\circ}$ C, T_A is the ambient temperature and the θ_{JA} is the junction to ambient thermal resistance.

For recommended operating conditions specification of RT9035, where $T_{J(MAX)}$ is the maximum junction temperature of the die (125 $^{\circ}$ C) and T_A is the maximum ambient temperature. The junction to ambient thermal resistance for WQFN-20L 4x4 package is 54 $^{\circ}$ C/W on the standard JEDEC 51-7 (4 layers, 2S2P) thermal test board. The copper thickness is 2oz. The maximum power dissipation at $T_A = 25^{\circ}$ C can be calculated by following formula:

$$P_{D(MAX)} = (125^{\circ}\text{C} - 25^{\circ}\text{C}) / (54^{\circ}\text{C/W}) = 1.852\text{W}$$

The maximum power dissipation depends on operating ambient temperature for fixed $T_{J(MAX)}$ and thermal resistance θ_{JA} . For RT9035 packages, the Figure 3 of de-rating curves allows the designer to see the effect of rising ambient temperature on the maximum power allowed.

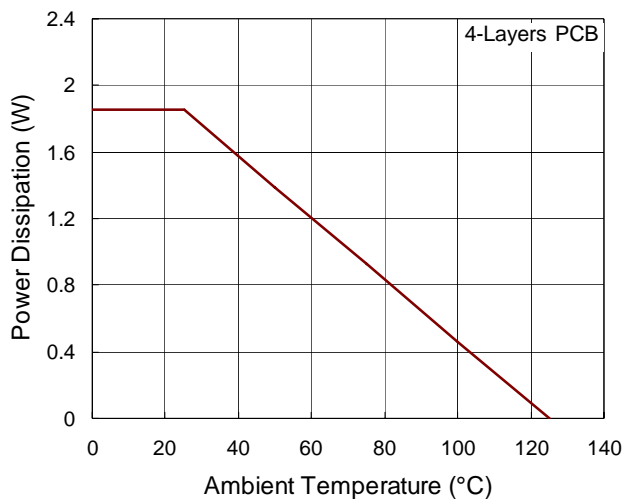
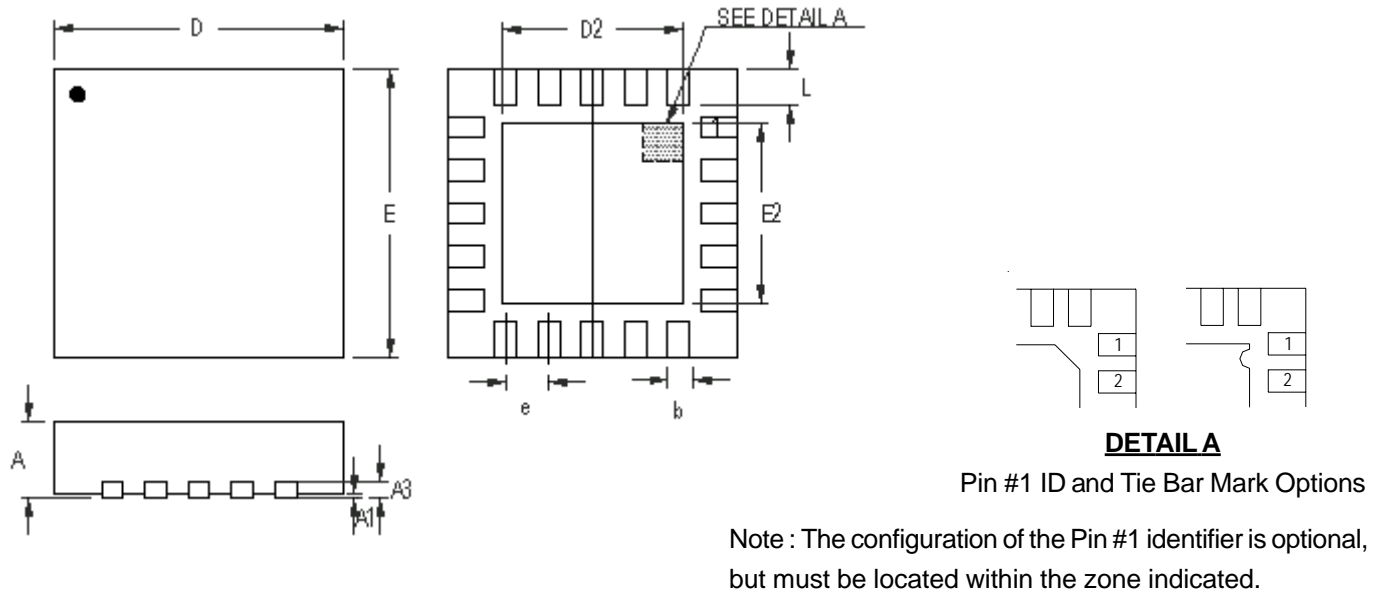

Figure 3. De-rating Curve

Outline Dimension



Symbol	Dimensions In Millimeters		Dimensions In Inches	
	Min	Max	Min	Max
A	0.700	0.800	0.028	0.031
A1	0.000	0.050	0.000	0.002
A3	0.175	0.250	0.007	0.010
b	0.150	0.300	0.006	0.012
D	3.950	4.050	0.156	0.159
D2	2.650	2.750	0.104	0.108
E	3.950	4.050	0.156	0.159
E2	2.650	2.750	0.104	0.108
e	0.500		0.020	
L	0.350	0.450	0.014	0.018

W-Type 20L QFN 4x4 Package

Richtek Technology Corporation

Headquarter
 5F, No. 20, Taiyuen Street, Chupei City
 Hsinchu, Taiwan, R.O.C.
 Tel: (8863)5526789 Fax: (8863)5526611

Richtek Technology Corporation

Taipei Office (Marketing)
 5F, No. 95, Minchiuan Road, Hsintien City
 Taipei County, Taiwan, R.O.C.
 Tel: (8862)86672399 Fax: (8862)86672377
 Email: marketing@richtek.com

Information that is provided by Richtek Technology Corporation is believed to be accurate and reliable. Richtek reserves the right to make any change in circuit design, specification or other related things if necessary without notice at any time. No third party intellectual property infringement of the applications should be guaranteed by users when integrating Richtek products into any application. No legal responsibility for any said applications is assumed by Richtek.