

Ultra-Low-Noise 200mA/500mA LDO Regulator

General Description

The RT9177/A is a 200mA/500mA low dropout and low noise micro-power regulator suitable for portable RF applications. The output voltage accuracy is within $\pm 2\%$ and range from 2.4V to 3.2V in 100mV increments could be selected. It is designed for using very low ESR output capacitor. Its output remains stable even when using a 1 μ F ceramic as its output capacitor.

With an internal PMOS as the pass device, it does not need extra GND current in heavy load and dropout conditions. In shutdown mode, nearly zero operation current makes the IC suitable for battery-power devices. Other features including current limiting and over temperature protection. The noise performance can be improved by connecting a capacitor to the bypass pin.

Ordering Information

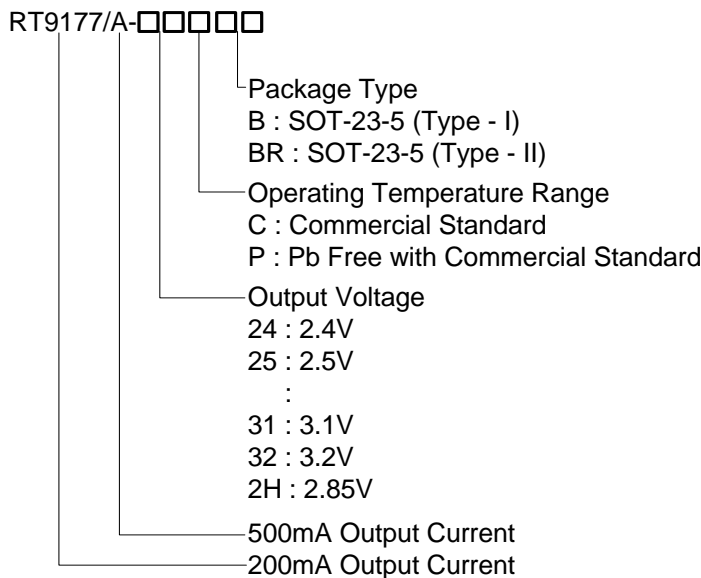

Note :

RichTek Pb-free products are :

- RoHS compliant and compatible with the current requirements of IPC/JEDEC J-STD-020.
- Suitable for use in SnPb or Pb-free soldering processes.
- 100% matte tin (Sn) plating.

Features

- Ultra-Low-Noise (150nV/ $\sqrt{\text{Hz}}$) for RF Application
- 1 μ F Ceramic C_{OUT} Stable
- Low Dropout Voltage (220mV @ 200mA)
- Low Operation Current - 80 μ A Typical
- Shutdown Function
- Low Temperature Coefficient
- Current and Thermal Limiting
- Customized Voltage Available
- SOT-23-5 Package
- RoHS Compliant and 100% Lead (Pb)-Free

Applications

- Cellular Phones
- Laptop, Notebook, and Palmtop Computers
- Battery-powered Equipment
- Hand-held Equipment

Marking Information

For marking information, contact our sales representative directly or through a RichTek distributor located in your area, otherwise visit our website for detail.

Pin Configurations

(TOP VIEW)

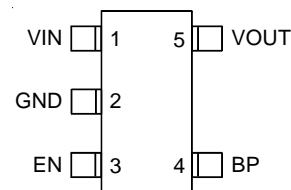

SOT-23-5 (Type - I)

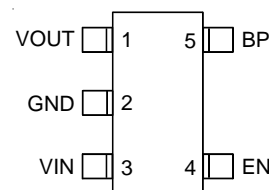

SOT-23-5 (Type - II)

Typical Application Circuit

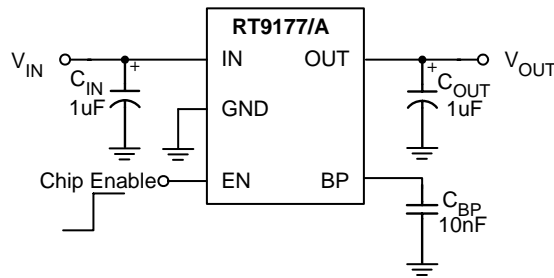

Functional Pin Description

Pin Name	Pin Function
VIN	Power Input Voltage
GND	Ground
EN	Chip Enable (Active High)
BP	Reference Noise Bypass
VOUT	Output Voltage

Function Block Diagram

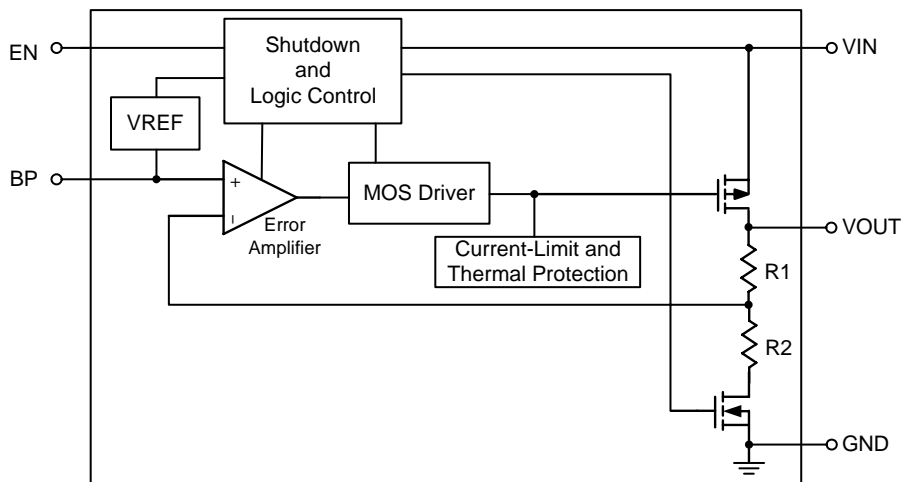

Absolute Maximum Ratings

- Input Voltage ----- 7V
- Power Dissipation, P_D @ $T_A = 25^\circ\text{C}$
 SOT-23-5 ----- 0.4W
- Package Thermal Resistance (Note 1)
 SOT-23-5, θ_{JA} ----- 250°C/W
- Operating Junction Temperature Range ----- -40°C to 125°C
- Storage Temperature Range ----- -65°C to 150°C
- Lead Temperature (Soldering, 10 sec.) ----- 260°C

Electrical Characteristics

($V_{IN} = 5.0\text{V}$, $C_{IN} = 1\mu\text{F}$, $C_{OUT} = 1\mu\text{F}$, $T_A = 25^\circ\text{C}$, unless otherwise specified)

Parameter	Symbol	Test Conditions	Min	Typ	Max	Units	
Input Voltage Range	V_{IN}		2.5	--	6	V	
Output Voltage Accuracy	ΔV_{OUT}	$I_L = 1\text{mA}$	-2	--	+2	%	
Maximum Output Current	RT9177	I_{MAX}	200	--	--	mA	
	RT9177A		500	--	--		
Current Limit	RT9177	I_{LIM}	--	300	--	mA	
	RT9177A			700			
Quiescent Current	RT9177/A	I_G	No Load	--	80	150	μA
	RT9177		$I_{OUT} = 200\text{mA}$	--	90	150	
	RT9177A		$I_{OUT} = 500\text{mA}$	--	90	150	
Dropout Voltage ⁽²⁾ ($V_{OUT}(\text{Nominal}) \geq 3.0\text{V}$ Version)	RT9177/A	V_{DROP}	$I_{OUT} = 1\text{mA}$	--	1.1	5	mV
	RT9177/A		$I_{OUT} = 50\text{mA}$	--	55	100	
	RT9177/A		$I_{OUT} = 200\text{mA}$	--	220	300	
	RT9177A		$I_{OUT} = 500\text{mA}$	--	550	700	
Line Regulation	ΔV_{LINE}	$V_{IN} = (V_{OUT} + 0.15)$ to 6V , $I_{OUT} = 1\text{mA}$	--	--	6	mV	
Load Regulation	RT9177	ΔV_{LOAD}	$I_{OUT} = 0\text{mA}$ to 200mA	--	--	20	mV
	RT9177A		$I_{OUT} = 0\text{mA}$ to 500mA	--	--	30	
EN Input High Threshold	V_{IH}		1.0	--	--	V	
EN Input Low Threshold	V_{IL}	$V_{IN} = 3\text{V}$ to 5.5V	--	--	0.4	V	
EN Bias Current	I_{SD}		--	--	100	nA	
Shutdown Supply Current	I_{GSD}	$V_{OUT} = 0\text{V}$	--	0.01	1	μA	
Thermal Shutdown Temperature	T_{SD}		--	150	--	$^\circ\text{C}$	
Output Noise	e_{NO}	$C_{BP} = 10\text{nF}$, $C_{OUT} = 10\mu\text{F}$	--	150	--	$\text{nV}/\sqrt{\text{Hz}}$	
Ripple Rejection	PSRR	$F = 100\text{Hz}$, $C_{BP} = 10\text{nF}$, $C_{OUT} = 10\mu\text{F}$	--	68	--	dB	

Note 1. θ_{JA} is measured in the natural convection at $T_A = 25^\circ\text{C}$ on a low effective thermal conductivity test board of JEDEC 51-3 thermal measurement standard

Note 2. The dropout voltage is defined as $V_{IN} - V_{OUT}$, which is measured when V_{OUT} is $V_{OUT}(\text{NORMAL}) - 100\text{mV}$.

Typical Operating Characteristics

Quiescent Current vs. Load

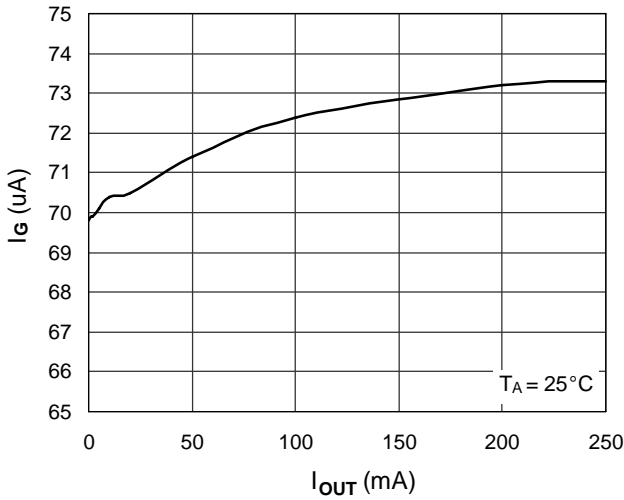

Output Voltage Variation vs. Load

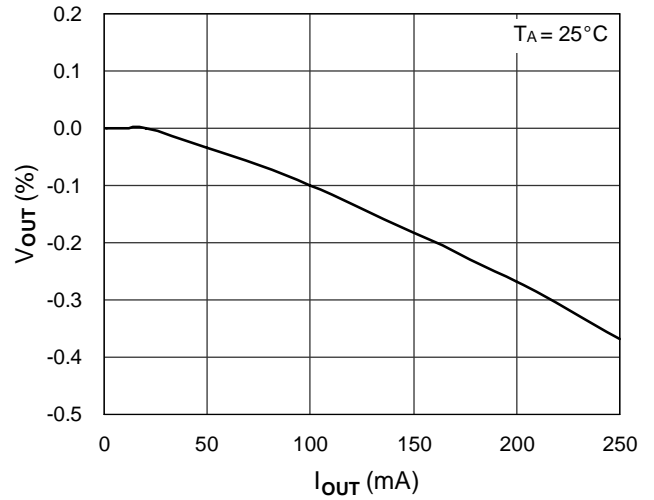

V_{OUT} vs. V_{IN}

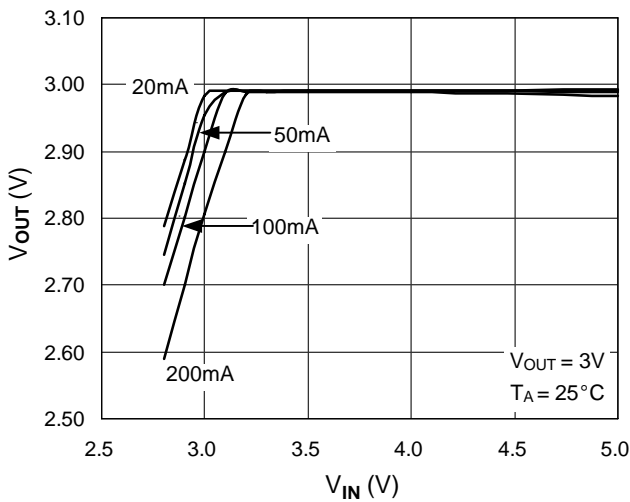

Dropout Voltage vs. Load Current

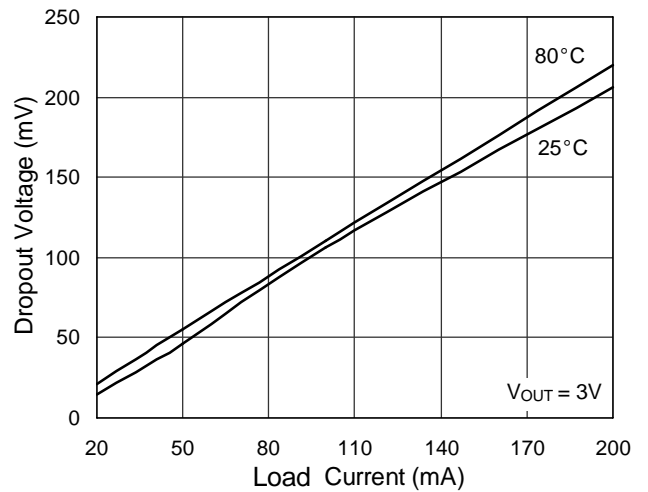

Output Voltage Variation vs. Temperature

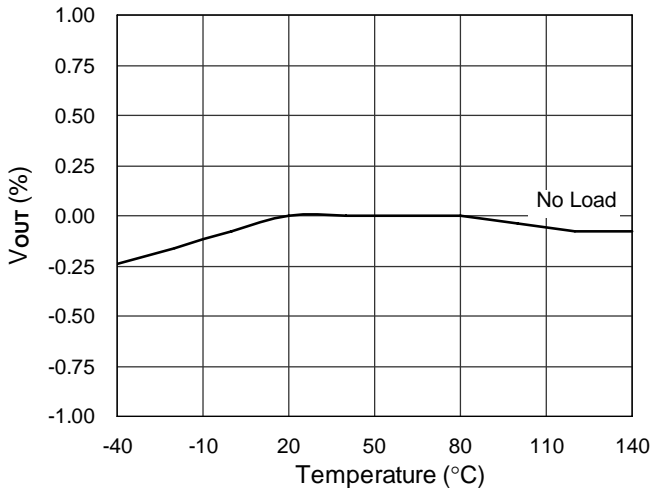

GND Current vs. Temperature

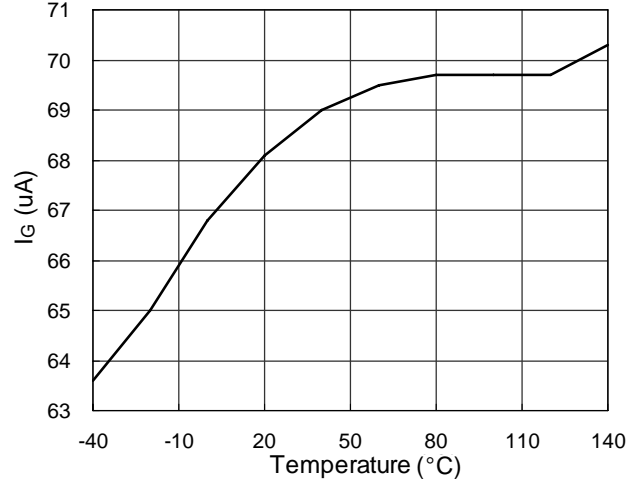

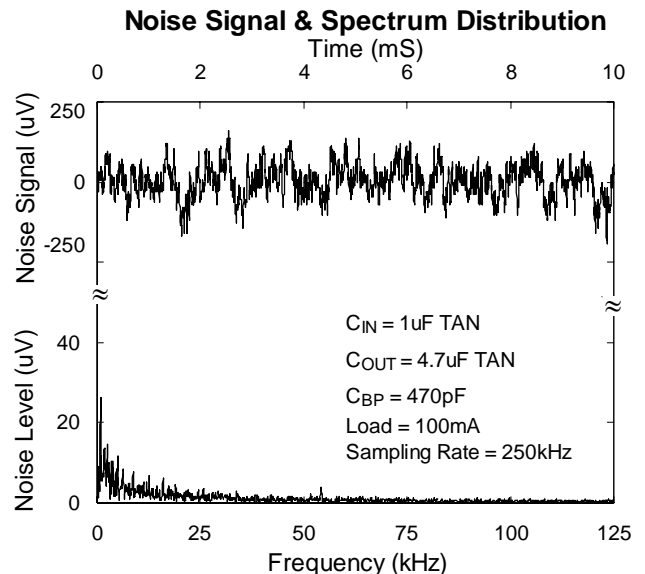
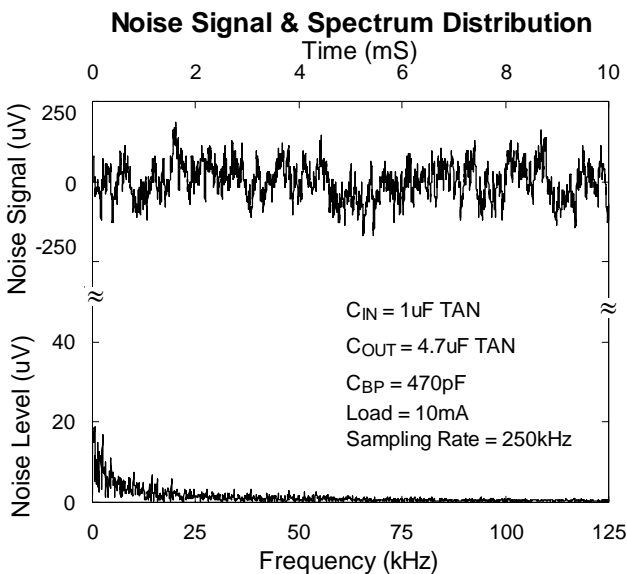
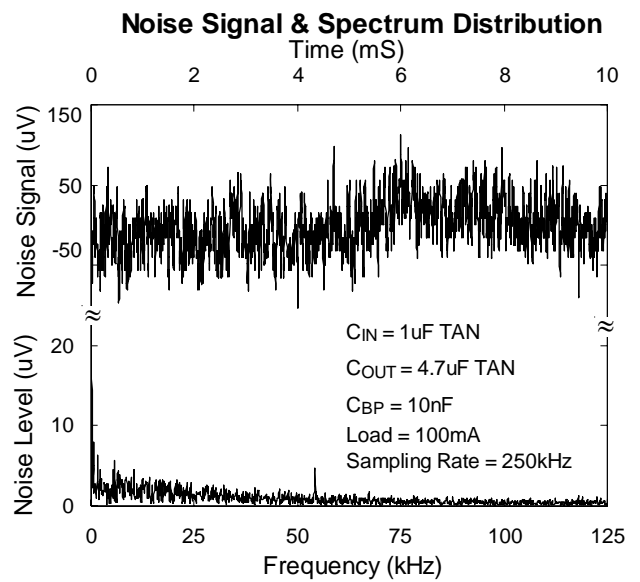
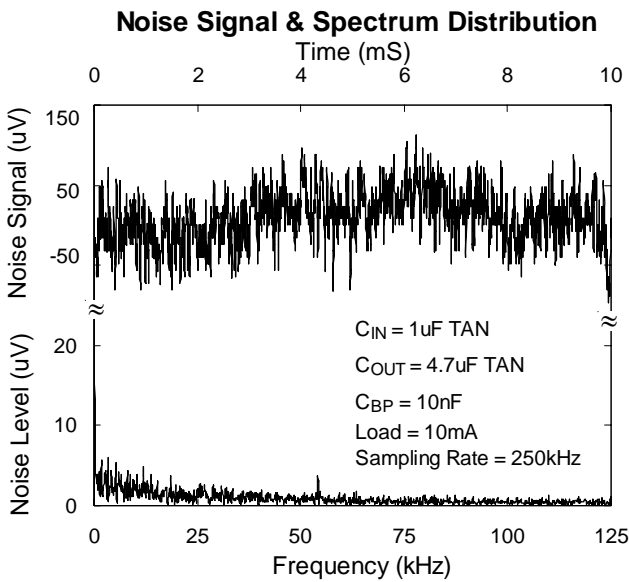
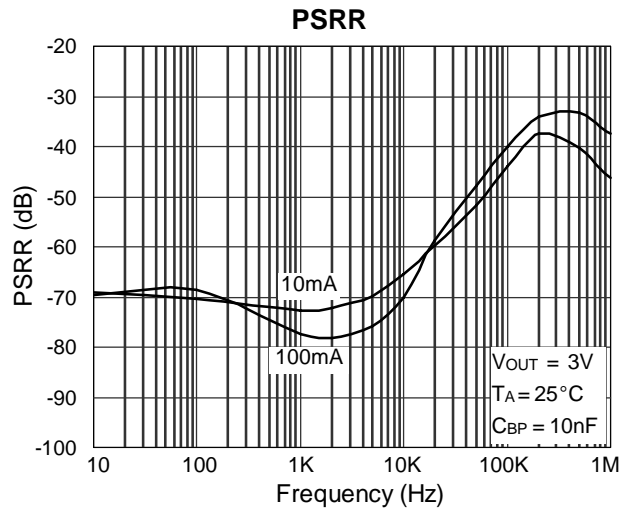
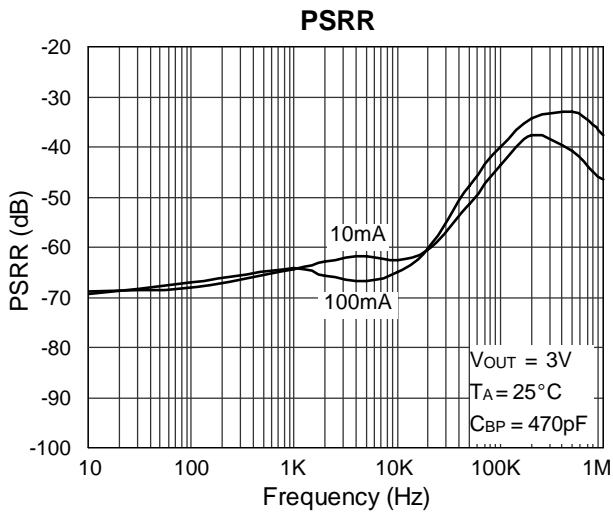

Load Transient Response
from 1mA to 100mA

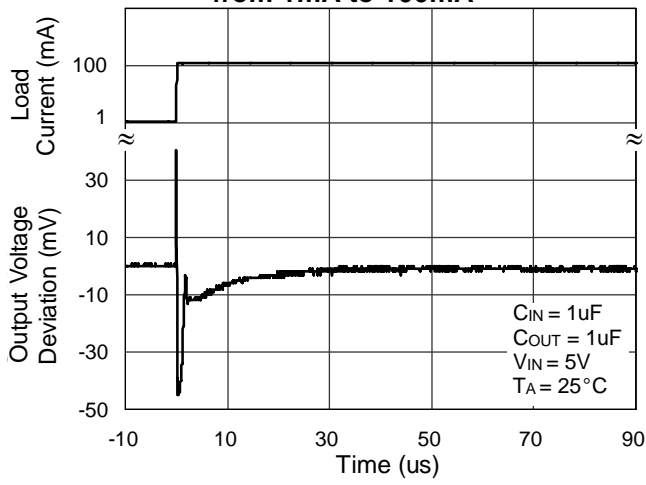

Load Transient Response
from 100mA to 1mA

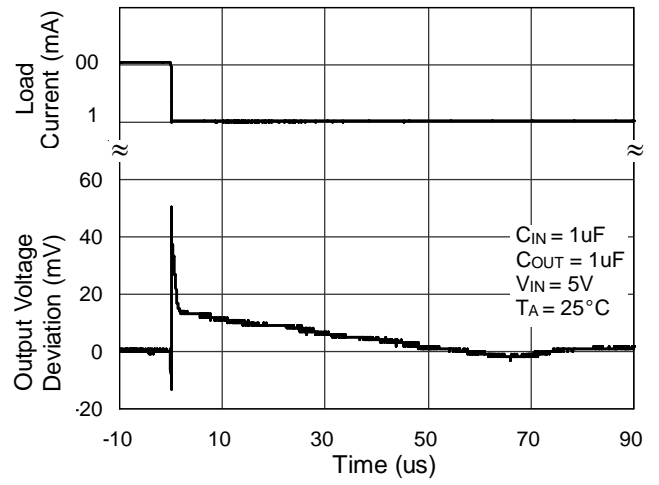

Application Information

Capacitor Selection and Regulator Stability

Like any low-dropout regulator, the external capacitors used with the RT9177/A must be carefully selected for regulator stability and performance.

Using a capacitor whose value is $\geq 1\mu\text{F}$ on the RT9177/A input and the amount of capacitance can be increased without limit. The input capacitor must be located at a distance of no more than 0.5" from the input pin of the IC and returned to a clean analog ground. Any good quality ceramic or tantalum can be used for this capacitor. The capacitor with larger value and lower ESR (equivalent series resistance) provides better PSRR and line-transient response.

The output capacitor must meet both requirements for minimum amount of capacitance and ESR in all LDO applications. The RT9177/A is designed specifically for working with low ESR ceramic output capacitor in space-saving and performance considerations. Using a ceramic capacitor whose value is at least $1\mu\text{F}$ with ESR is $> 5\text{m}\Omega$ on the RT9177/A output ensures stability. The RT9177/A works well even with a output capacitor of other types due to the wide stable ESR range. Figure 1. shows the curves of allowable ESR range as a function of load current for various output voltages and capacitor values. An output capacitor of larger capacitance can reduce noise and improve load-transient response, stability, and PSRR. The output capacitor should be located not more than 0.5" from the V_{OUT} pin of the RT9177/A and return to a clean analog ground.

Note that some ceramic dielectrics exhibit large capacitance and ESR variation with temperature. It may be necessary to use $2.2\mu\text{F}$ or more to ensure stability at temperatures below -10°C in this case. Also, tantalum capacitors, $2.2\mu\text{F}$ or more may be needed to maintain capacitance and ESR in the stable region for strict application environment.

Tantalum capacitors maybe suffer failure due to surge currents when it is connected to a low-impedance source of power (like a battery or very large capacitor). If a tantalum capacitor is used at the input, it must be guaranteed to have a surge current rating sufficient for the application by the manufacture.

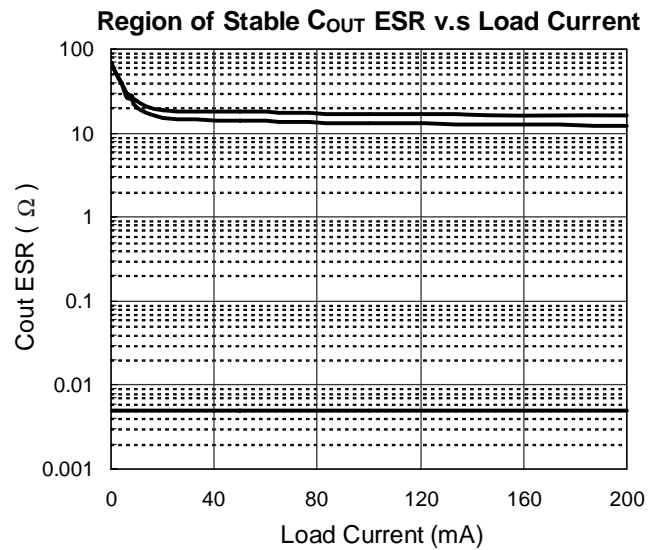

Figure 1

Use a 10nF bypass capacitor at BP for low output voltage noise. The capacitor, in conjunction with an internal $200\text{k}\Omega$ resistor, which connects bypass pin and the band-gap reference, creates an 80Hz low-pass filter for noise reduction. Increasing the capacitance will slightly decrease the output noise, but increase the start-up time. The capacitor connected to the bypass pin for noise reduction must have very low leakage. This capacitor leakage current causes the output voltage to decline by a proportional amount to the current due to the voltage drop on the internal $200\text{k}\Omega$ resistor. Figure 2. shows the power on response.

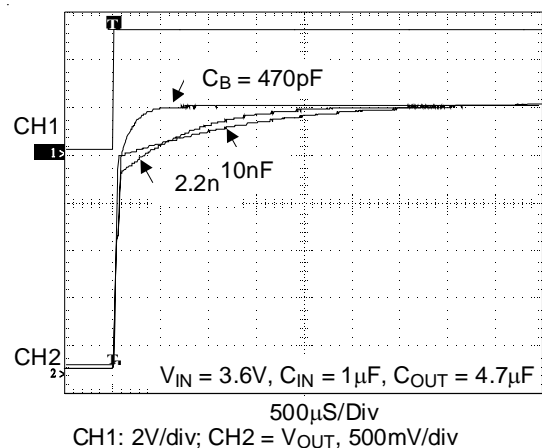

Figure 2

Load-Transient Considerations

The RT9177/A load-transient response graphs (see Typical Operating Characteristics) show two components of the output response: a DC shift from the output impedance due to the load current change, and the transient response. The DC shift is quite small due to the excellent load regulation of the IC. Typical output voltage transient spike for a step change in the load current from 1mA to 100mA is tens mV, depending on the ESR of the output capacitor. Increasing the output capacitor's value and decreasing the ESR attenuates the overshoot.

Shutdown Input Operation

The RT9177/A is shutdown by pulling the EN input low, and turned on by driving the input high. If this feature is not to be used, the EN input should be tied to V_{IN} to keep the regulator on at all times (the EN input must not be left floating).

To ensure proper operation, the signal source used to drive the EN input must be able to swing above and below the specified turn-on/turn-off voltage thresholds which guarantee an ON or OFF state (see Electrical Characteristics). The ON/OFF signal may come from either CMOS output, or an open-collector output with pull-up resistor to the RT9177/A input voltage or another logic supply. The high-level voltage may exceed the RT9177/A input voltage, but must remain within the absolute maximum ratings for the EN pin.

Internal P-Channel Pass Transistor

The RT9177/A features a typical 1.1Ω P-Channel MOSFET pass transistor. It provides several advantages over similar designs using PNP pass transistors, including longer battery life. The P-Channel MOSFET requires no base drive, which reduces quiescent current considerably. PNP-based regulators waste considerable current in dropout when the pass transistor saturates. They also use high base-drive currents under large loads. The RT9177/A does not suffer from these problems and consume only $80\mu\text{A}$ of quiescent current whether in dropout, light-load, or heavy-load applications.

Input-Output (Dropout) Voltage

A regulator's minimum input-output voltage differential (or dropout voltage) determines the lowest usable supply voltage. In battery-powered systems, this will determine the useful end-of-life battery voltage. Because the RT9177/A uses a P-Channel MOSFET pass transistor, the dropout voltage is a function of drain-to-source on-resistance [$R_{DS(ON)}$] multiplied by the load current.

Reverse Current Path

The power transistor used in the RT9177/A has an inherent diode connected between the regulator input and output (see Figure 3). If the output is forced above the input by more than a diode-drop, this diode will become forward biased and current will flow from the V_{OUT} terminal to V_{IN} . This diode will also be turned on by abruptly stepping the input voltage to a value below the output voltage. To prevent regulator mis-operation, a Schottky diode should be used in any applications where input/output voltage conditions can cause the internal diode to be turned on (see Figure 4). As shown, the Schottky diode is connected in parallel with the internal parasitic diode and prevents it from being turned on by limiting the voltage drop across it to about 0.3V and $< 100\text{ mA}$ to prevent mis-operation to damage the part.

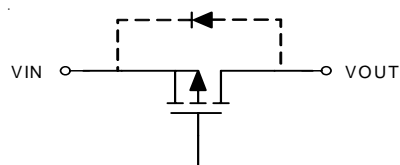

Figure 3

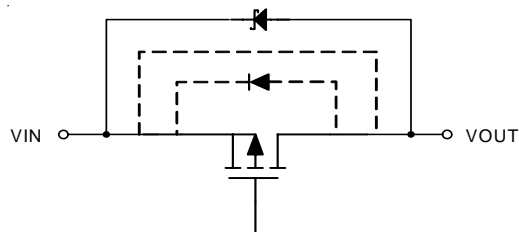

Figure 4

Operating Region and Power Dissipation

The maximum power dissipation of RT9177/A depends on the thermal resistance of the case and circuit board, the temperature difference between the die junction and ambient air, and the rate of airflow. The power dissipation across the device is $P = I_{OUT} (V_{IN} - V_{OUT})$. The maximum power dissipation is:

$$P_{MAX} = (T_J - T_A) / \theta_{JA}$$

where $T_J - T_A$ is the temperature difference between the RT9177/A die junction and the surrounding environment, θ_{JA} is the thermal resistance from the junction to the surrounding environment. The GND pin of the RT9177/A performs the dual function of providing an electrical connection to ground and channeling heat away. Connect the GND pin to ground using a large pad or ground plane.

Current Limit and Thermal Protection

The RT9177/A is included a current limit circuit used to monitor and control the pass transistor's gate voltage to limit the output current to 300mA in typical and thermal over load protection circuit used to limit total power dissipation. When the junction temperature exceeds $T_J = 150^\circ\text{C}$, the thermal sensor signals the shutdown logic to turn off the pass transistor and allow the IC to cool down. The thermal sensor will turn on the pass transistor again after the IC's junction temperature cool down to 120°C . This will cause a pulsing output during continuous thermal-overload conditions. Thermal-overloaded protection is designed to protect the RT9177/A in the event of fault conditions. Do not exceed the absolute maximum junction temperature rating of $T_J = 125^\circ\text{C}$ for continuous operation. The output can be shorted to ground for an indefinite amount of time without damaging the part by cooperation of current limit and thermal protection.

Outline Dimension

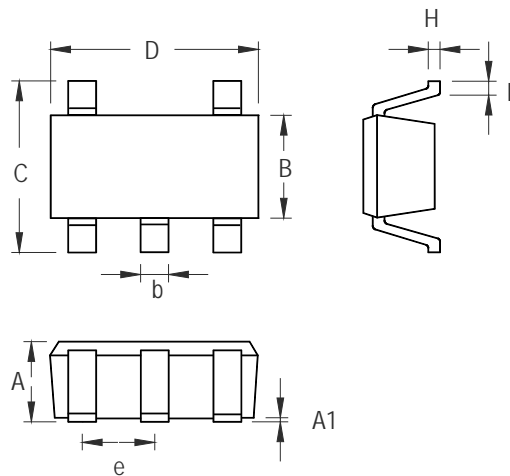

Symbol	Dimensions In Millimeters		Dimensions In Inches	
	Min	Max	Min	Max
A	0.889	1.295	0.035	0.051
A1	0.000	0.152	0.000	0.006
B	1.397	1.803	0.055	0.071
b	0.356	0.559	0.014	0.022
C	2.591	2.997	0.102	0.118
D	2.692	3.099	0.106	0.122
e	0.838	1.041	0.033	0.041
H	0.080	0.254	0.003	0.010
L	0.300	0.610	0.012	0.024

SOT-23-5 Surface Mount Package

RICHTEK TECHNOLOGY CORP.

Headquarter

5F, No. 20, Taiyuen Street, Chupei City

Hsinchu, Taiwan, R.O.C.

Tel: (8863)5526789 Fax: (8863)5526611

RICHTEK TECHNOLOGY CORP.

Taipei Office (Marketing)

8F-1, No. 137, Lane 235, Paochiao Road, Hsintien City

Taipei County, Taiwan, R.O.C.

Tel: (8862)89191466 Fax: (8862)89191465

Email: marketing@richtek.com