

# Dual, Ultra-Low Quiescent, 100mA CMOS LDO Regulator

## General Description

The RT9188 series are an efficient, precise dual-channel CMOS LDO regulator optimized for ultra-low-quiescent applications. Both regulator outputs are capable of sourcing 100mA of output current.

The RT9188's performance is optimized for battery-powered systems to deliver extremely low dropout voltage and ultra-low quiescent current. Regulator ground current increases only slightly in dropout, further prolonging the battery life. The RT9188 also works with low-ESR ceramic capacitors, reducing the amount of board space necessary for power applications, critical in hand-held wireless devices.

Key features include current limit, thermal shutdown, faster transient response, ultra-low quiescent current (typically 8µA), low dropout voltage, high output accuracy, current limiting protection, and high ripple rejection ratio. Available in the SOT-23-5 package, the RT9188 also offers a range of 1.2V to 5V with 0.1V per step.

## Ordering Information

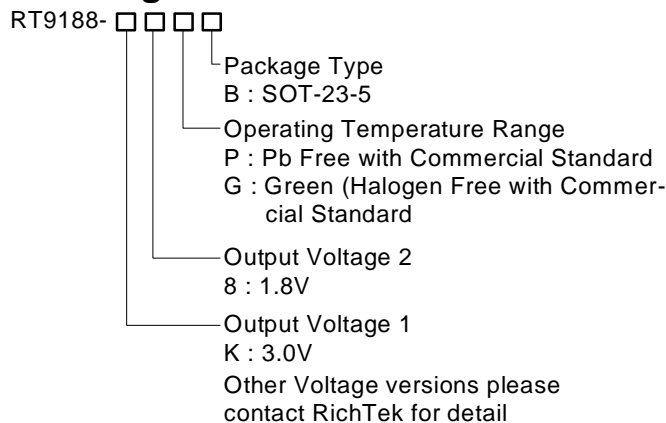

Note :

- RichTek Pb-free and Green products are :
  - }RoHS compliant and compatible with the current requirements of IPC/JEDEC J-STD-020.
  - }Suitable for use in SnPb or Pb-free soldering processes.
  - }100%matte tin (Sn) plating.

## Features

- | Ultra-Low Quiescent Current (Typically 8mA)
- | Low Dropout : 450mV at 100mA
- | Wide Operating Voltage Ranges : 2V to 6V
- | Faster Transient Response
- | Tight Load and Line Regulation
- | Current Limiting Protection
- | Thermal Shutdown Protection
- | Only 1mF Output Capacitor Required for Stability
- | High Power Supply Rejection Ratio
- | Custom Voltages Available
- | RoHS Compliant and 100% Lead (Pb)-Free

## Applications

- | Cellular Phones and Pages
- | Battery-Powered Equipment
- | Laptop, Palmtops, Notebook Computers
- | Hand-Held Instruments
- | PCMCIA Card
- | Wireless LAN Card/Keyboard/Mouse

## Marking Information

For marking information, contact our sales representative directly or through a RichTek distributor located in your area, otherwise visit our website for detail.

## Pin Configurations

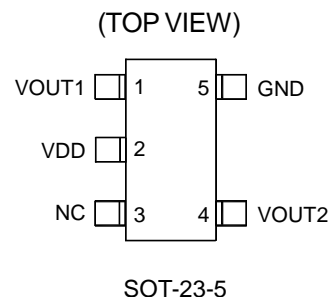

Typical Application Circuit

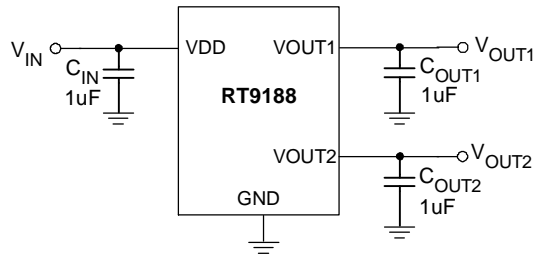

Function Block Diagram

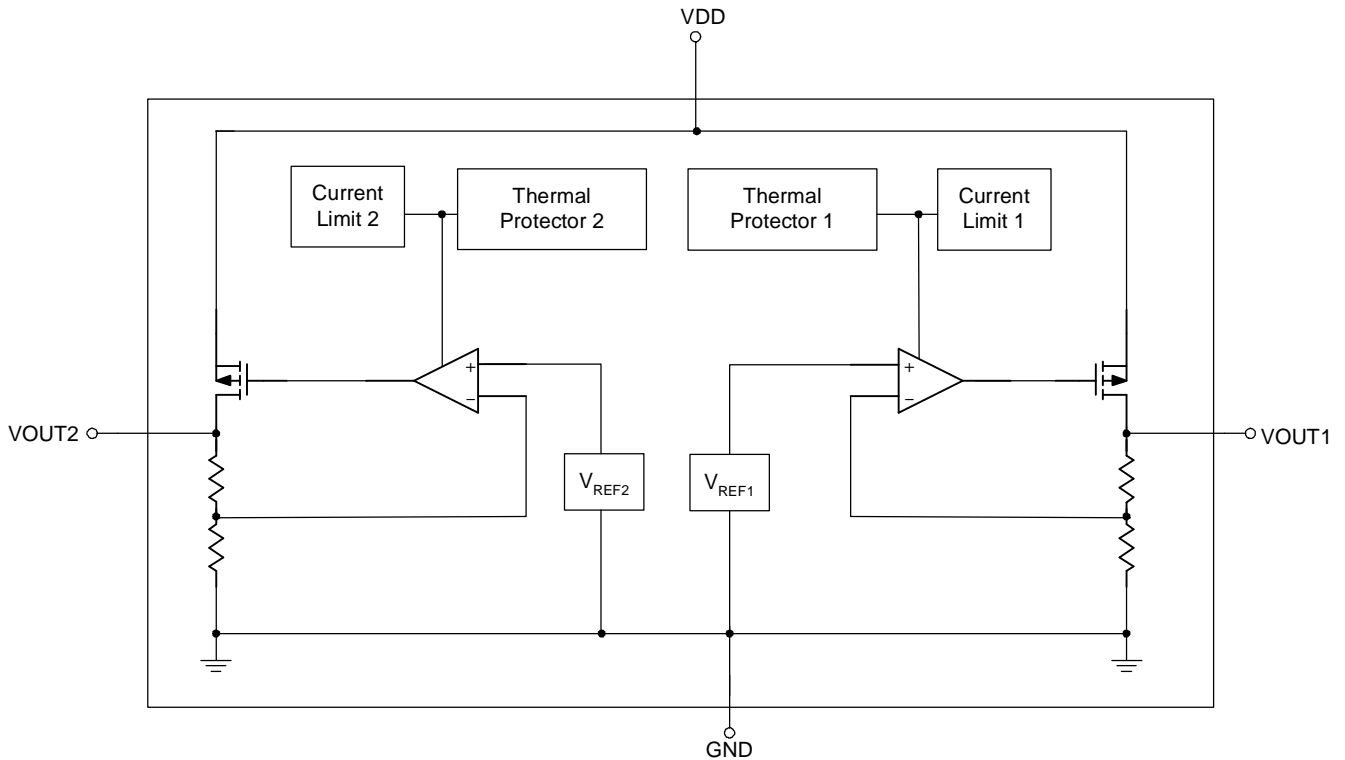

Functional Pin Description

Pin Name	Pin Function
VDD	Supply Input
VOUT1	Channel 1 Output Voltage
VOUT2	Channel 2 Output Voltage
GND	Common Ground
NC	No Internal Connection

**Absolute Maximum Ratings** (Note 1)

Supply Input Voltage -----	7V
Power Dissipation, P <sub>D</sub> @ T <sub>A</sub> = 25°C	
SOT-23-5 -----	0.4W
Package Thermal Resistance (Note 7)	
SOT-23-5, θ <sub>JA</sub> -----	250°C/W
Junction Temperature -----	150°C
Lead Temperature (Soldering, 10 sec.) -----	260°C
Storage Temperature Range -----	-65°C to 150°C
ESD Susceptibility (Note 2)	
HBM (Human Body Mode) -----	2kV
MM (Machine Mode) -----	200V

**Recommended Operating Conditions** (Note 3)

Supply Input Voltage -----	2V to 6V
Junction Temperature Range -----	-40°C to 125°C

**Electrical Characteristics**

(V<sub>DD</sub> = 5V, C<sub>IN</sub> = 1μF, C<sub>OUT</sub> = 1μF, T<sub>A</sub> = 25°C, for each LDO unless otherwise specified)

Parameter	Symbol	Test Conditions	Min	Typ	Max	Units
Output Voltage Accuracy	ΔV <sub>OUT</sub>	I <sub>OUT</sub> = 1mA	-2	--	+2	%
Current Limit	I <sub>LIM</sub>	R <sub>LOAD</sub> = 1Ω	150	450	--	mA
Quiescent Current (both LDOs) (Note 6)	I <sub>Q</sub>	I <sub>OUT</sub> = 0mA	--	8	14	μA
Dropout Voltage (Note 4)	V <sub>DROP</sub>	I <sub>OUT</sub> = 50mA, V <sub>DD</sub> ≥ 3.6V	--	200	300	mV
		I <sub>OUT</sub> = 100mA, V <sub>DD</sub> ≥ 3.6V	--	380	600	
Line Regulation	ΔV <sub>LINE</sub>	V <sub>DD</sub> = (V <sub>OUT (MAX)</sub> + 0.3V) to 6V, I <sub>OUT</sub> = 1mA	-0.2	--	+0.2	%/V
Load Regulation (Note 5)	ΔV <sub>LOAD</sub>	I <sub>OUT</sub> = 1mA to 100mA	--	0.01	0.04	%/mA
Output Noise Voltage	e <sub>NO</sub>	BW = 100Hz to 50kHz C <sub>OUT</sub> = 10μF	--	250	--	μVrms
Power Supply Rejection Rate	PSRR	f = 1kHz, C <sub>OUT</sub> = 1μF	--	-30	--	dB
Thermal Shutdown Protection	T <sub>SD</sub>		125	--	--	°C

- Note 1.** Stresses listed as the above "Absolute Maximum Ratings" may cause permanent damage to the device. These are for stress ratings. Functional operation of the device at these or any other conditions beyond those indicated in the operational sections of the specifications is not implied. Exposure to absolute maximum rating conditions for extended periods may remain possibility to affect device reliability.
- Note 2.** Devices are ESD sensitive. Handling precaution recommended.
- Note 3.** The device is not guaranteed to function outside its operating conditions.
- Note 4.** The dropout voltage is defined as  $V_{IN} - V_{OUT}$ , which is measured when  $V_{OUT}$  is  $V_{OUT(NORMAL)} - 100mV$ .
- Note 5.** Regulation is measured at constant junction temperature by using a 20ms current pulse. Devices are tested for load regulation in the load range from 1mA to 100mA.
- Note 6.** Quiescent, or ground current, is the difference between input and output currents. It is defined by  $I_Q = I_{IN} - I_{OUT}$  under no load condition ( $I_{OUT} = 0mA$ ). The total current drawn from the supply is the sum of the load current plus the ground pin current.
- Note 7.**  $\theta_{JA}$  is measured in the natural convection at  $T_A = 25^\circ C$  on a low effective thermal conductivity test board of JEDEC 51-3 thermal measurement standard.

Typical Operating Characteristics

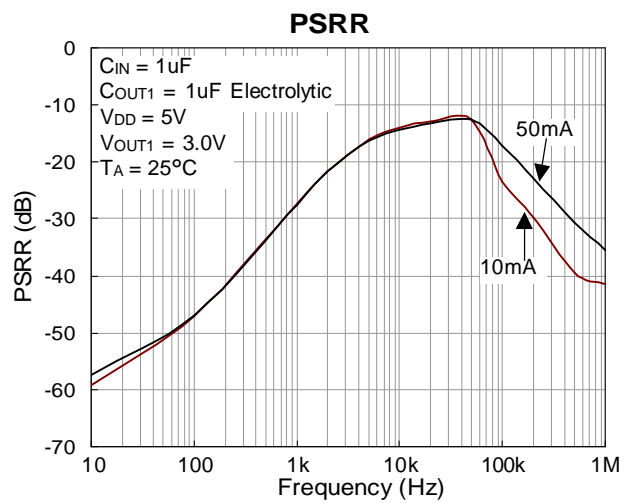
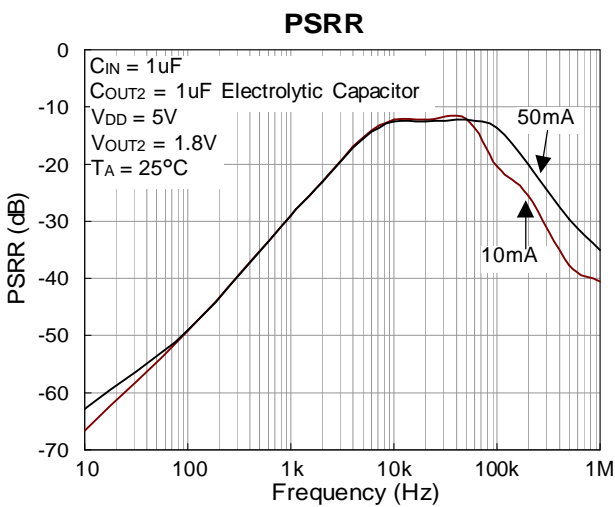
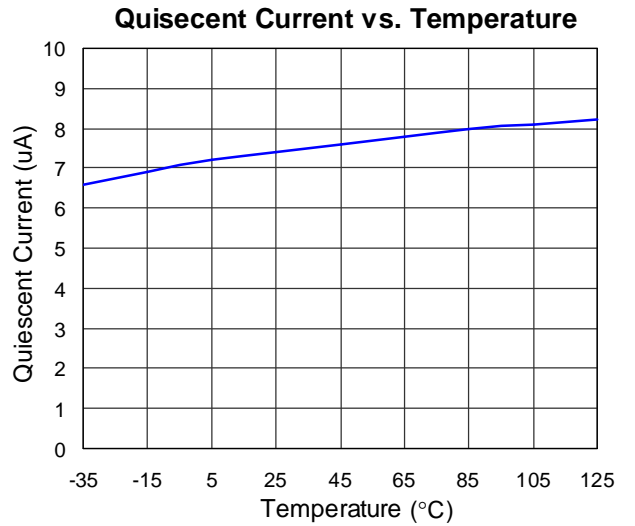
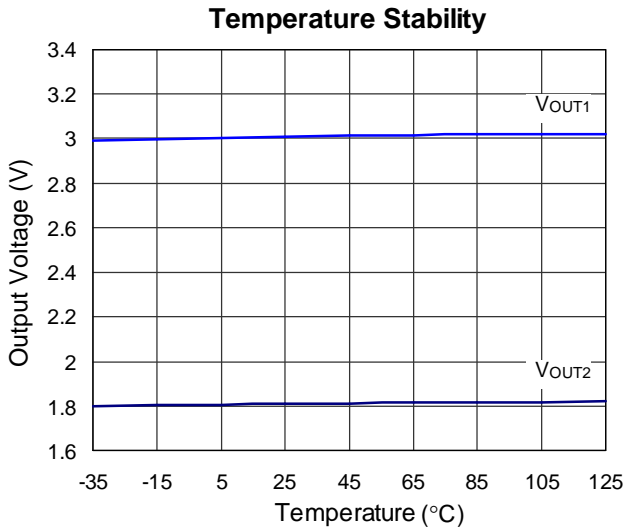
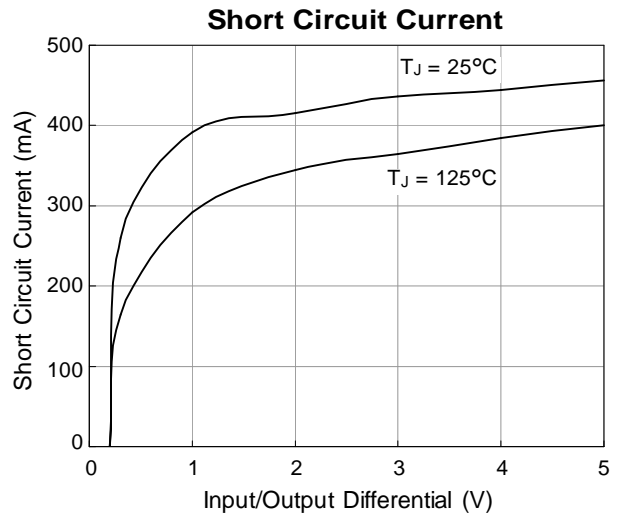
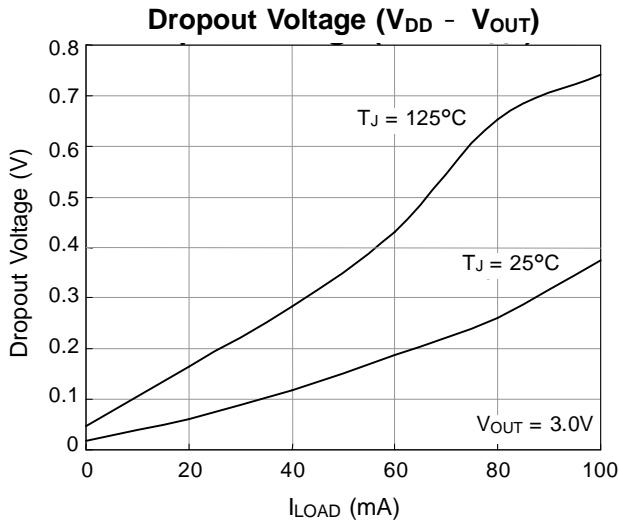

Line Transient Response

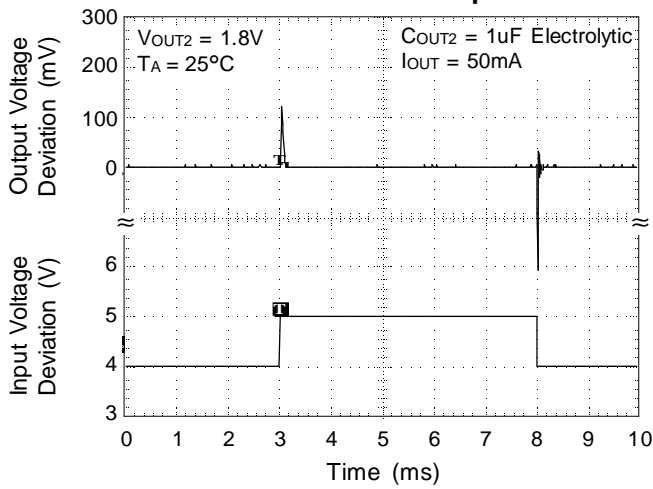

Line Transient Response

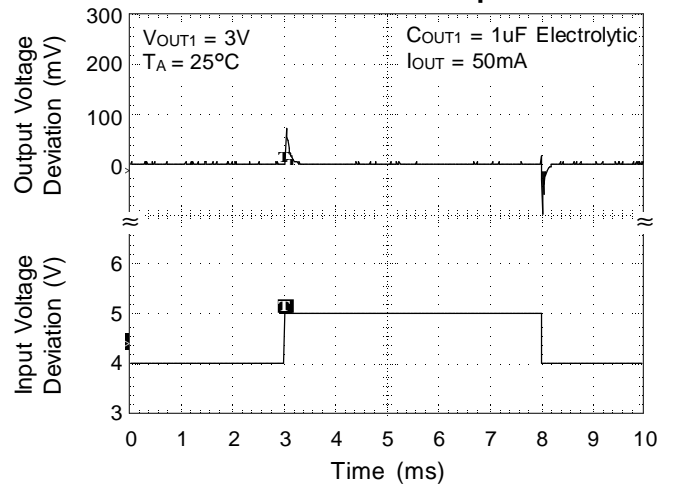

Load Transient Response

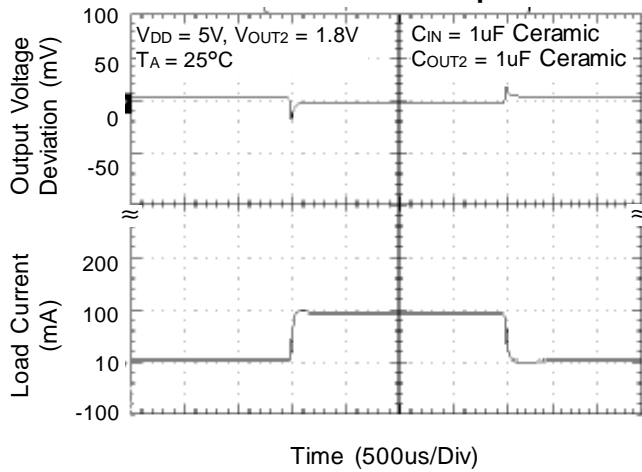

Load Transient Response

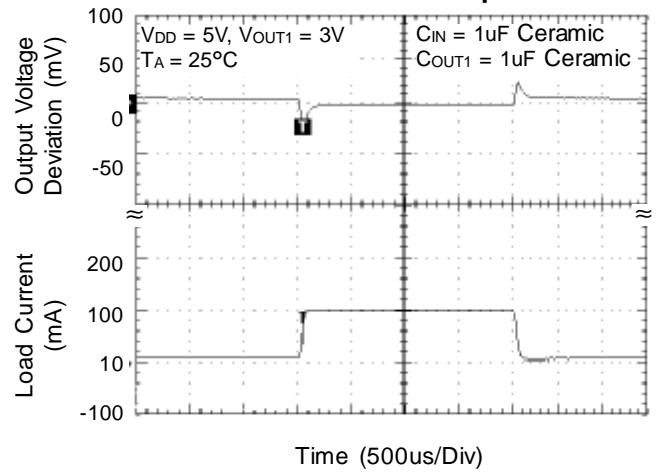

Current Limit vs. Input Voltage

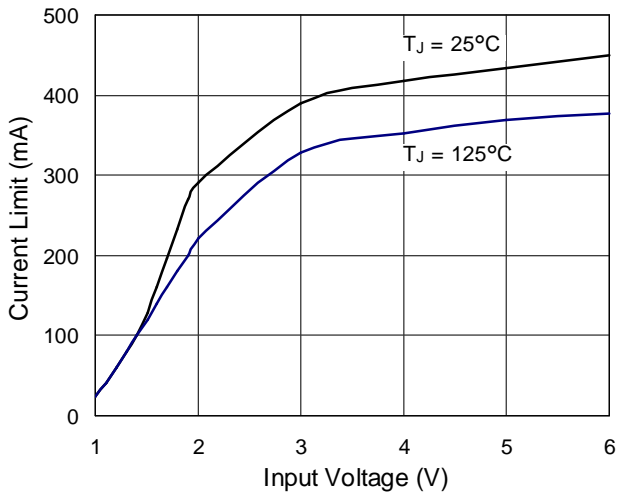

## Application Information

Like any low-dropout regulator, the RT9188 requires input and output decoupling capacitors. The device is specifically designed for portable applications requiring minimum board space and smallest components. These capacitors must be correctly selected for good performance (see Capacitor Characteristics Section). Please note that linear regulators with a low dropout voltage have high internal loop gains which require care in guarding against oscillation caused by insufficient decoupling capacitance.

### Input Capacitor

An input capacitance of  $\cong 1\mu\text{F}$  is required between the device input pin and ground directly (the amount of the capacitance may be increased without limit). The input capacitor **MUST** be located less than 1 cm from the device to assure input stability (see PCB Layout Section). A lower ESR capacitor allows the use of less capacitance, while higher ESR type (like aluminum electrolytic) require more capacitance.

Capacitor types (aluminum, ceramic and tantalum) can be mixed in parallel, but the total equivalent input capacitance/ESR must be defined as above to stable operation.

There are no requirements for the ESR on the input capacitor, but tolerance and temperature coefficient must be considered when selecting the capacitor to ensure the capacitance will be  $\cong 1\mu\text{F}$  over the entire operating temperature range.

### Output Capacitor

The RT9188 is designed specifically to work with very small ceramic output capacitors. The recommended minimum capacitance (temperature characteristics X7R or X5R) in  $1\mu\text{F}$  to  $4.7\mu\text{F}$  range with  $10\text{m}\Omega$  to  $50\text{m}\Omega$  range ceramic capacitor between LDO output and GND for transient stability, but it may be increased without limit. Higher capacitance values help to improve transient.

The output capacitor's ESR is critical because it forms a zero to provide phase lead which is required for loop stability.

### No Load Stability

The device will remain stable and in regulation with no external load. This is specially important in CMOS RAM keep-alive applications.

### Input-Output (Dropout) Voltage

A regulator's minimum input-to-output voltage differential (dropout voltage) determines the lowest usable supply voltage. In battery-powered systems, this determines the useful end-of-life battery voltage. Because the device uses a PMOS, its dropout voltage is a function of drain-to-source on-resistance,  $R_{\text{DS(ON)}}$ , multiplied by the load current:

$$V_{\text{DROPOUT}} = V_{\text{DD}} - V_{\text{OUT}} = R_{\text{DS(ON)}} \times I_{\text{OUT}}$$

### Current Limit

The RT9188 monitors and controls the PMOS' gate voltage, limiting the output current to 450mA (typ). The output can be shorted to ground for an indefinite period of time without damaging the part.

### Short-Circuit Protection

The device is short circuit protected and in the event of a peak over-current condition, the short-circuit control loop will rapidly drive the output PMOS pass element off. Once the power pass element shuts down, the control loop will rapidly cycle the output on and off until the average power dissipation causes the thermal shutdown circuit to respond to servo the on/off cycling to a lower frequency. Please refer to the section on thermal information for power dissipation calculations.

### Capacitor Characteristics

It is important to note that capacitance tolerance and variation with temperature must be taken into consideration when selecting a capacitor so that the minimum required amount of capacitance is provided over the full operating temperature range. In general, a good tantalum capacitor will show very little capacitance variation with temperature, but a ceramic may not be as good (depending on dielectric type).

Aluminum electrolytics also typically have large temperature variation of capacitance value.

Equally important to consider is a capacitor's ESR change with temperature: this is not an issue with ceramics, as their ESR is extremely low. However, it is very important in Tantalum and aluminum electrolytic capacitors. Both show increasing ESR at colder temperatures, but the increase in aluminum electrolytic capacitors is so severe they may not be feasible for some applications.

**Ceramic:**

For values of capacitance in the 10 $\mu$ F to 100 $\mu$ F range, ceramics are usually larger and more costly than tantalums but give superior AC performance for bypassing high frequency noise because of very low ESR (typically less than 10m $\Omega$ ). However, some dielectric types do not have good capacitance characteristics as a function of voltage and temperature.

Z5U and Y5V dielectric ceramics have capacitance that drops severely with applied voltage. A typical Z5U or Y5V capacitor can lose 60% of its rated capacitance with half of the rated voltage applied to it. The Z5U and Y5V also exhibit a severe temperature effect, losing more than 50% of nominal capacitance at high and low limits of the temperature range.

X7R and X5R dielectric ceramic capacitors are strongly recommended if ceramics are used, as they typically maintain a capacitance range within  $\pm 20\%$  of nominal over full operating ratings of temperature and voltage. Of course, they are typically larger and more costly than Z5U/Y5U types for a given voltage and capacitance.

**Tantalum:**

Solid tantalum capacitors are recommended for use on the output because their typical ESR is very close to the ideal value required for loop compensation. They also work well as input capacitors if selected to meet the ESR requirements previously listed.

Tantalums also have good temperature stability: a good quality tantalum will typically show a capacitance value that varies less than 10~15% across the full temperature range of 125°C to -40°C. ESR will vary only about 2X going from the high to low temperature limits.

The increasing ESR at lower temperatures can cause oscillations when marginal quality capacitors are used (if the ESR of the capacitor is near the upper limit of the stability range at room temperature).

**Aluminum:**

This capacitor type offers the most capacitance for the money. The disadvantages are that they are larger in physical size, not widely available in surface mount, and have poor AC performance (especially at higher frequencies) due to higher ESR and ESL.

Compared by size, the ESR of an aluminum electrolytic is higher than either Tantalum or ceramic, and it also varies greatly with temperature. A typical aluminum electrolytic can exhibit an ESR increase of as much as 50X when going from 25°C down to -40°C.

It should also be noted that many aluminum electrolytics only specify impedance at a frequency of 120Hz, which indicates they have poor high frequency performance. Only aluminum electrolytics that have an impedance specified at a higher frequency (between 20kHz and 100kHz) should be used for the device. Derating must be applied to the manufacturer's ESR specification, since it is typically only valid at room temperature.

Any applications using aluminum electrolytics should be thoroughly tested at the lowest ambient operating temperature where ESR is maximum.



**Thermal Considerations**

The RT9188 is a dual channel CMOS regulator designed to provide two output voltage from one package. Each output pin the RT9188 can deliver a current of up to 100mA over the full operating junction temperature range. However, the maximum output current must be derated at higher ambient temperature to ensure the junction temperature does not exceed 125°C. With all possible conditions, the junction temperature must be within the range specified under operating conditions. Each regulator contributes power dissipation to the overall power dissipation of the package. Power dissipation can be calculated based on the output current and the voltage drop across each regulator.

$$P_D = (V_{DD} - V_{OUT1}) I_{OUT1} + (V_{DD} - V_{OUT2}) I_{OUT2} + V_{IN} I_{GND}$$

Each output is rated for 100mA of output current, but the application may limit the amount of output current based on the total power dissipation and the ambient temperature. The final operating junction temperature for any set of conditions can be estimated by the following thermal equation:

$$P_{D(MAX)} = (T_{J(MAX)} - T_A) / \theta_{JA}$$

Where  $T_{J(MAX)}$  is the maximum junction temperature of the die (125°C) and  $T_A$  is the maximum ambient temperature. The junction to ambient thermal resistance ( $\theta_{JA}$ ) for SOT-23-5 package at recomm-ended minimum footprint is 250°C/W ( $\theta_{JA}$  is layout dependent). Visit our website in which "Recommended Footprints for Soldering Surface Mount Packages" for detail.

**PCB Layout**

Good board layout practices must be used or instability can be induced because of ground loops and voltage drops. The input and output capacitors **MUST** be directly connected to the input, output, and ground pins of the device using traces which have no other currents flowing through them.

The best way to do this is to layout  $C_{IN}$  and  $C_{OUT}$  near the device with short traces to the  $V_{DD}$ ,  $V_{OUT}$ , and ground pins.

The regulator ground pin should be connected to the external circuit ground so that the regulator and its capacitors have a "single point ground".

It should be noted that stability problems have been seen in applications where vias to an internal ground plane were used at the ground points of the device and the input and output capacitors. This was caused by varying ground potentials at these nodes resulting from current flowing through the ground plane. Using a single point ground technique for the regulator and it's capacitors fixed the problem. Since high current flows through the traces going into  $V_{IN}$  and coming from  $V_{OUT}$ , Kelvin connect the capacitor leads to these pins so there is no voltage drop in series with the input and output capacitors.

Optimum performance can only be achieved when the device is mounted on a PC board according to the diagram below:

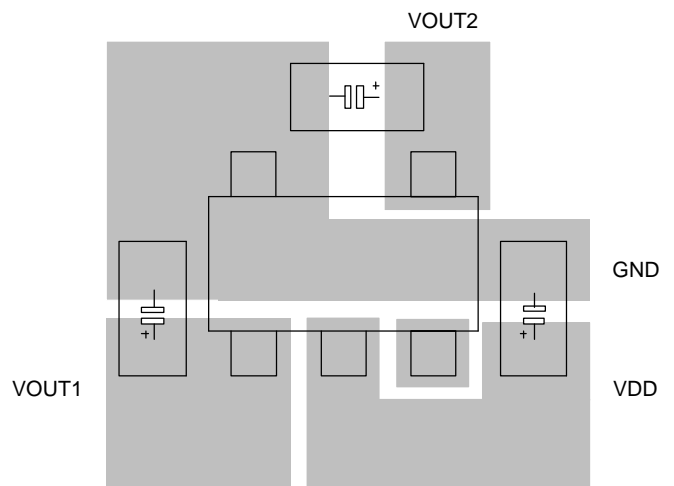

SOT-23-5 Board Layout

Outline Dimension

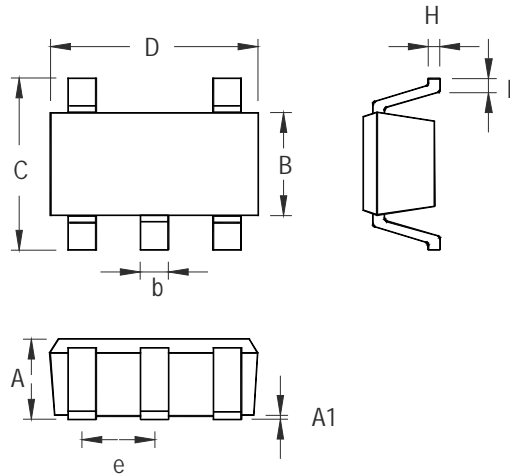

Symbol	Dimensions In Millimeters		Dimensions In Inches	
	Min	Max	Min	Max
A	0.889	1.295	0.035	0.051
A1	0.000	0.152	0.000	0.006
B	1.397	1.803	0.055	0.071
b	0.356	0.559	0.014	0.022
C	2.591	2.997	0.102	0.118
D	2.692	3.099	0.106	0.122
e	0.838	1.041	0.033	0.041
H	0.080	0.254	0.003	0.010
L	0.300	0.610	0.012	0.024

SOT-23-5 Surface Mount Package

**Richtek Technology Corporation**

Headquarter  
 5F, No. 20, Taiyuen Street, Chupei City  
 Hsinchu, Taiwan, R.O.C.  
 Tel: (8863)5526789 Fax: (8863)5526611

**Richtek Technology Corporation**

Taipei Office (Marketing)  
 8F, No. 137, Lane 235, Paochiao Road, Hsintien City  
 Taipei County, Taiwan, R.O.C.  
 Tel: (8862)89191466 Fax: (8862)89191465  
 Email: marketing@richtek.com