

Linear Single Cell Li-Ion Battery Charger with Auto Power Path Management

General Description

The RT9519 is an integrated single-cell Li-ion battery charger with auto power path management (APPM). No external MOSFETs are required. The RT9519 enters sleep mode when power is removed. Charging tasks are optimized by using a control algorithm to vary the charge rate, including pre-charge mode, fast charge mode and constant voltage mode. For the RT9519, the charge current can also be programmed with an external resistor and modified with an external GPIO. The scope that the battery regulation voltage can be modified with an external GPIO depends on the battery temperature. The internal thermal feedback circuitry regulates the die temperature to optimize the charge rate for all ambient temperatures. The charging task will always be terminated in constant voltage mode when the charging current reduces to the termination current of 10% x ICHG_FAST. Other features include under voltage protection and over voltage protection for VIN supply.

The recommended junction temperature range spans from -40°C to 125°C, while the ambient temperature range extends from -40°C to 85°C.

Ordering Information

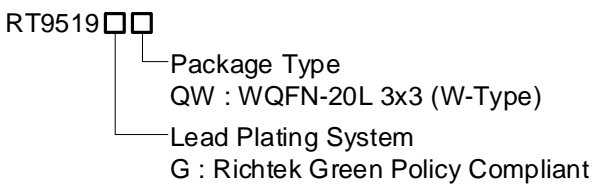

Note:

Richtek products are Richtek Green Policy compliant and compatible with the current requirements of IPC/JEDEC J-STD-020.

Marking Information

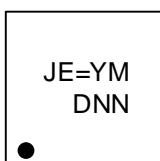

JE= : Product Code
YMDNN : Date Code

Features

- 28V Maximum Rating for VIN Power
- Selectable Power Current Limit (0.1A / 0.5A / 1.5A)
- Integrated Power MOSFETs
- Auto Power Path Management (APPM)
- Battery Charging Current Control
- Battery Regulation Voltage Control
- Voltage Detector by VDET and RESET Pin
- Programmable Charging Current and Safe Charge Timer
- Under Voltage Protection, Over Voltage Protection
- Power Good and Charge Status Indicator
- Optimized Charge Rate via Thermal Feedback
- Thin 20-Lead WQFN Package
- RoHS Compliant and Halogen Free

Applications

- Digital Cameras
- PDAs and Smart Phones
- Portable Instruments

Pin Configuration

(TOP VIEW)

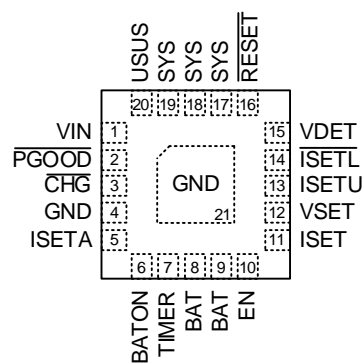

WQFN-20L 3x3

Typical Application Circuit

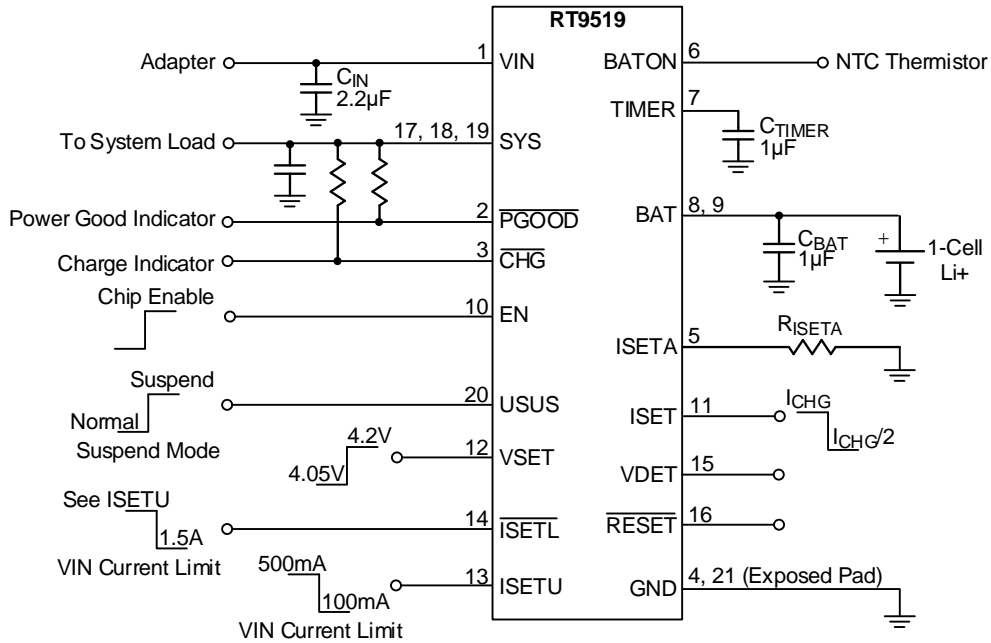

Functional Block Diagram

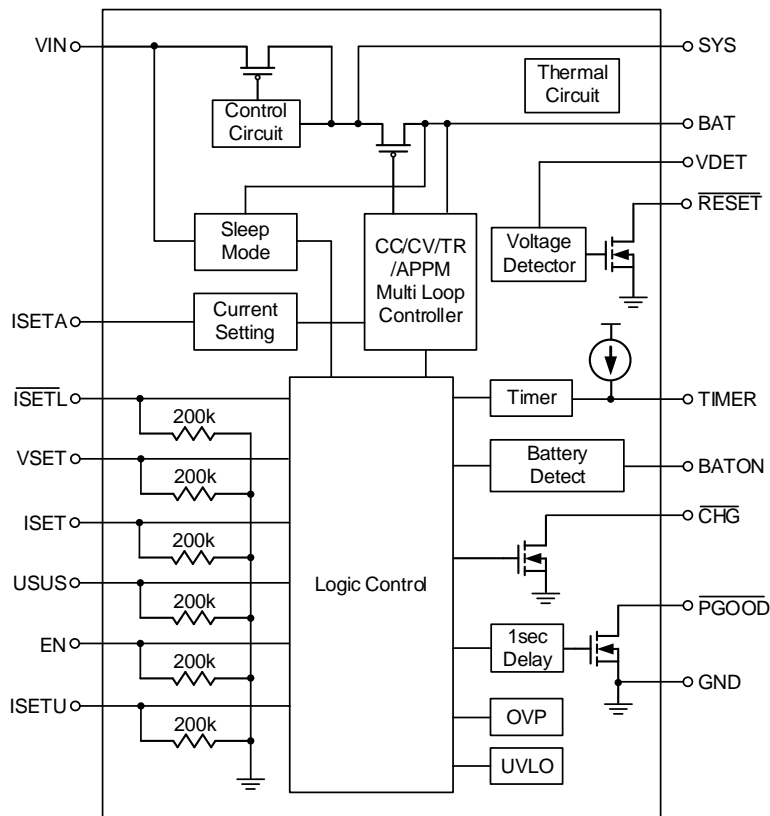

Functional Pin Description

Pin No.	Pin Name	Pin Function
1	VIN	Supply voltage input.
2	$\overline{\text{PGOOD}}$	Power good status output. Active low, open-drain output.
3	$\overline{\text{CHG}}$	Charger status output. Active low, open-drain output.
4, 21 (Exposed Pad)	GND	Ground. The exposed pad must be soldered to a large PCB and connected to GND for maximum power dissipation.
5	ISETA	Charge current set input. Connect a resistor (R _{ISETA}) between ISETA and GND. I _{CHG_FAST} = (V _{ISETA} / R _{ISETA}) x 300. I _{CHG_PRE} = 10% x I _{CHG_FAST} .
6	BATON	Battery detector pin. Detect the presence of battery. Connect BATON to the NTC thermistor. If battery is not presence, charge function disables.
7	TIMER	Safe charge timer setting.
8, 9	BAT	Battery charge current output.
10	EN	Charge enable. Active high input. 200kΩ pull low.
11	ISET	Half charge current set input. Control by external GPIO, L = I _{CHG1} /2, H = I _{CHG1} , 200kΩ pull low.
12	VSET	VBAT set input. Control by external GPIO. L = 4.05V, H = 4.2V, 200kΩ pull low.
13	ISETU	VIN current limit control input. When $\overline{\text{ISETL}}$ = H, L = 100mA, H = 500mA, 200kΩ pull low.
14	$\overline{\text{ISETL}}$	VIN current limit control input. H : see ISETU, L = 1.5A, 200kΩ pull low.
15	VDET	Voltage detection input.
16	$\overline{\text{RESET}}$	Open-drain output. $\overline{\text{RESET}}$ = High Z, when V _{DET} >1V.
17, 18, 19	SYS	System connect pin. Connect this pin to system with a minimum 10μF ceramic capacitor connected to GND.
20	USUS	VIN suspend control input. H = Suspend, L = No suspend. 200kΩ pull low.

Absolute Maximum Ratings (Note 1)

- Supply Input Voltage, V_{IN} ----- -0.3V to 28V
- \overline{CHG} , \overline{PGOOD} , \overline{RESET} ----- -0.3V to 28V
- Other Pins ----- -0.3V to 6V
- BAT Continuous Current (Total in Two Pins) (Note 2) ----- 2.5A
- Power Dissipation, P_D @ $T_A = 25^\circ\text{C}$
 WQFN-20L 3x3 ----- 1.471W
- Package Thermal Resistance (Note 3)
 WQFN-20L 3x3, θ_{JA} ----- 68°C/W
 WQFN-20L 3x3, θ_{JC} ----- 7.5°C/W
- Lead Temperature (Soldering, 10sec.) ----- 260°C
- Junction Temperature ----- 150°C
- Storage Temperature Range ----- -65°C to 150°C
- ESD Susceptibility (Note 4)
 HBM (Human Body Model) ----- 2kV
 MM (Machine Model) ----- 200V

Recommended Operating Conditions (Note 5)

- Supply Input Voltage Range, V_{IN} ($\overline{ISETL} = L$) ----- 4.35V to 6V
- Supply Input Voltage Range, V_{IN} ($\overline{ISETL} = H$) ----- 4.4V to 6V
- Ambient Temperature Range ----- -40°C to 85°C
- Junction Temperature Range ----- -40°C to 125°C

Electrical Characteristics

($V_{IN} = 5\text{V}$, $V_{BAT} = 4\text{V}$, $T_A = 25^\circ\text{C}$, unless otherwise specified)

Parameter	Symbol	Test Conditions	Min	Typ	Max	Unit
Supply Input						
VIN Under Voltage Lockout Threshold	V_{UVLO}	$V_{IN} = 0\text{V}$ to 4V	3.1	3.3	3.5	V
VIN Under Voltage Lockout Hysteresis	ΔV_{UVLO}	$V_{IN} = 4\text{V}$ to 0V	--	240	--	mV
VIN Supply Current	I_{SUPPLY}	$I_{SYS} = I_{BAT} = 0\text{mA}$, $EN = H$ ($V_{BAT} > V_{REGx}$)	--	1	2	mA
		$I_{SYS} = I_{BAT} = 0\text{mA}$, $EN = L$ ($V_{BAT} > V_{REGx}$)	--	0.8	1.5	mA
VIN Suspend Current	I_{USUS}	$V_{IN} = 5\text{V}$, $USUS = H$	--	195	333	μA
VBAT Sleep Leakage Current	I_{SLEEP}	$V_{BAT} > V_{IN}$, ($V_{IN} = 0\text{V}$)	--	5	15	μA
VIN-BAT VOS Rising	V_{OS_H}		--	100	200	mV
VIN-BAT VOS Falling	V_{OS_L}		10	50	--	mV
Voltage Regulation						

Parameter	Symbol	Test Conditions	Min	Typ	Max	Unit
Battery Regulation Voltage Accuracy1	VREG1	Loading = 20mA When VSET = H	4.16	4.2	4.23	V
Battery Regulation Voltage Accuracy2	VREG2	Loading = 20mA When VSET = L	4.01	4.05	4.08	V
System Regulation Voltage	VSYS	ISYS = 800mA	4.3	4.4	4.5	V
APPM Regulation Voltage	VAPPM		3.85	3.95	4.05	V
DPM Regulation Voltage	VDPM	$\overline{\text{ISETL}} = \text{H}$	4.2	4.3	4.4	V
VIN to VSYS MOSFET On-Resistance	RDS(ON)	IVIN = 1000mA	--	0.2	0.35	Ω
BAT to VSYS MOSFET On-Resistance	RDS(ON)	VBAT = 4.2V, ISYS = 1A	--	0.05	0.1	Ω
Re-Charge Threshold	$\Delta\text{VREGCHG}$	Battery Regulation – Recharge level	60	100	140	mV
Current Regulation						
ISETA Set Voltage (Fast Charge Phase)	VISETA	VBAT = 4V, RISETA = 1k Ω	--	2	--	V
VIN Charge Setting Range	ICHG		100	--	1200	mA
VIN Charge Current Accuracy1	ICHG1	VBAT = 4V, RISETA = 1k Ω ISET = H	570	600	630	mA
VIN Charge Current Accuracy2	ICHG2	VBAT = 3.8V, RISETA = 1k Ω ISET = L	285	300	315	mA
VIN Current Limit	IVIN	$\overline{\text{ISETL}} = \text{L}$ (1.5A Mode)	1	1.5	1.8	A
		$\overline{\text{ISETL}} = \text{H}$, ISETU = H (500mA Mode)	430	475	500	mA
		$\overline{\text{ISETL}} = \text{H}$, ISETU = L (100mA Mode)	70	90	100	mA
Pre-Charge						
BAT Pre-Charge Threshold	VPRECH	BAT Falling	2.7	2.8	2.9	V
BAT Pre-Charge Threshold Hysteresis	ΔVPRECH		--	200	--	mV
Pre-Charge Current	ICHG_PRE	VBAT = 2V	5	10	15	%
Charge Termination Detection						
Termination Current Ratio to Fast Charge (Except USB100 Mode)	ITERM	$\overline{\text{ISETL}} = \text{H}$, ISETU = H $\overline{\text{ISETL}} = \text{L}$, ISETU = X	5	10	15	%
Termination Current Ratio to Fast Charge (USB100 Mode)	ITERM2	$\overline{\text{ISETL}} = \text{H}$, ISETU = L	--	3.3	--	%
Login Input/Output						
$\overline{\text{CHG}}$ Pull Down Voltage	$\overline{\text{VCHG}}$	$\overline{\text{ICHG}} = 5\text{mA}$	--	200	--	mV
$\overline{\text{PGOOD}}$ Pull Down Voltage	$\overline{\text{VPGOOD}}$	$\overline{\text{IPGOOD}} = 5\text{mA}$	--	200	--	mV
$\overline{\text{RESET}}$ Pull Down Voltage	$\overline{\text{VRESET}}$	$\overline{\text{IRESET}} = 5\text{mA}$	--	200	--	mV
EN, ISETL, USUS, ISETU, VSET, ISET Threshold Voltage	Logic-High	VIH	1.5	--	--	V
	Logic-Low	VIL	--	--	0.4	

Parameter	Symbol	Test Conditions	Min	Typ	Max	Unit
Protection						
Thermal Regulation	T _{REG}		--	125	--	°C
Thermal Shutdown Temperature	T _{SD}		--	155	--	°C
Thermal Shutdown Hysteresis	ΔT _{SD}		--	20	--	°C
Over Voltage Protection	V _{OVP}	V _{IN} Rising	6.25	6.5	6.75	V
Over Voltage Protection Hysteresis	ΔV _{OVP}	V _{IN} = 7V to 5V, V _{OVP} – ΔV _{OVP}	--	100	--	mV
VDET	V _{DET}	VDET Falling	0.98	1	1.02	V
BATON	V _{BATON}	BATON Rising	2.8	2.9	3	V
Output Short Circuit Detection Threshold	V _{SHORT}	V _{BAT} –V _{SYS}	--	300	--	mV
Time						
Pre-Charge Fault Time	t _{PCHG}	C _{TIMER} = 1μF (1/8 x t _{FCHG})	1440	1800	2160	s
Fast Charge Fault Time	t _{FCHG}	C _{TIMER} = 1μF	11520	14400	17280	s
PGOOD Deglitch Time	t _{PGOOD}	Time measured from V _{IN} : 0→5V 1μs rise time to PGOOD = L	--	1	--	s
Input Over Voltage Blanking Time	t _{OVP}		--	50	--	μs
Pre-Charge to Fast-Charge Deglitch Time	t _{PF}		--	25	--	ms
Fast-Charge to Pre-Charge Deglitch Time	t _{FP}		--	25	--	ms
Termination Deglitch Time	t _{TERMI}		--	25	--	ms
Recharge Deglitch Time	t _{RECHG}		--	100	--	ms
Input Power Loss to SYS LDO Turn-Off Delay Time	t _{NO_IN}		--	25	--	ms
Short Circuit, Deglitch Time	t _{SHORT}		--	250	--	μs
Short Circuit Recovery Time	t _{SHORT-R}		--	64	--	ms

Note 1. Stresses beyond those listed under “Absolute Maximum Ratings” June cause permanent damage to the device. These are stress ratings only, and functional operation of the device at these or any other conditions beyond those indicated in the operational sections of the specifications is not implied. Exposure to absolute maximum rating conditions June affect device reliability.

Note 2. Guaranteed by design.

Note 3. θ_{JA} is measured under natural convection (still air) at T_A = 25°C with the component mounted on a high effective-thermal-conductivity four-layer test board on a JEDEC 51-7 thermal measurement standard. θ_{JC} is measured at the exposed pad of the package.

Note 4. Devices are ESD sensitive. Handling precautions are recommended.

Note 5. The device is not guaranteed to function outside its operating conditions.

Typical Operating Characteristics

Charger On/Off Control from EN

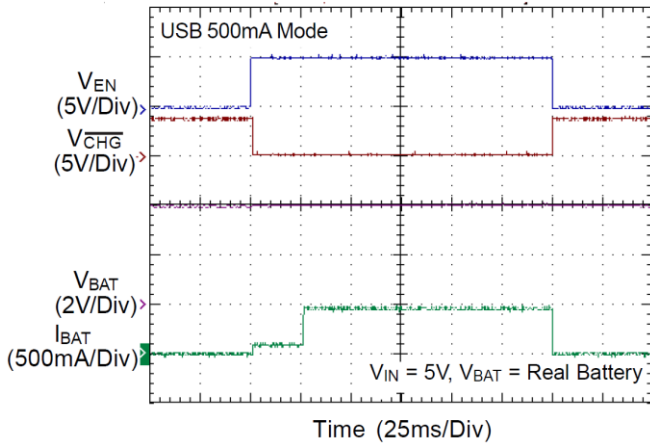

Charger On/Off Control from VIN

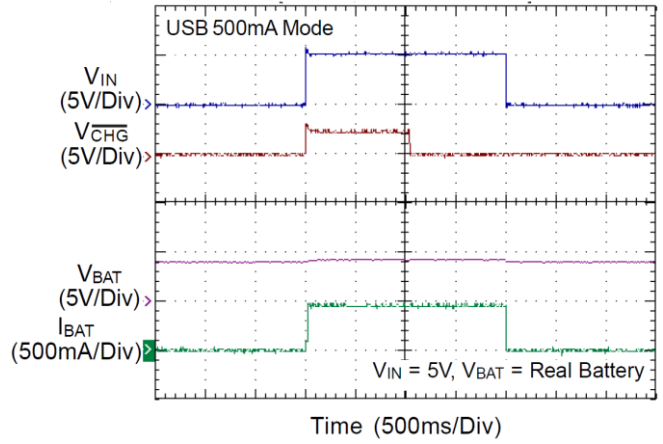

V_{IN} Removal

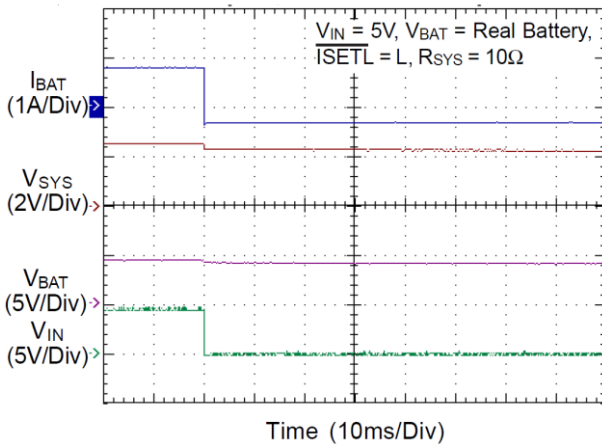

V_{IN} Hot-Plug Without Battery

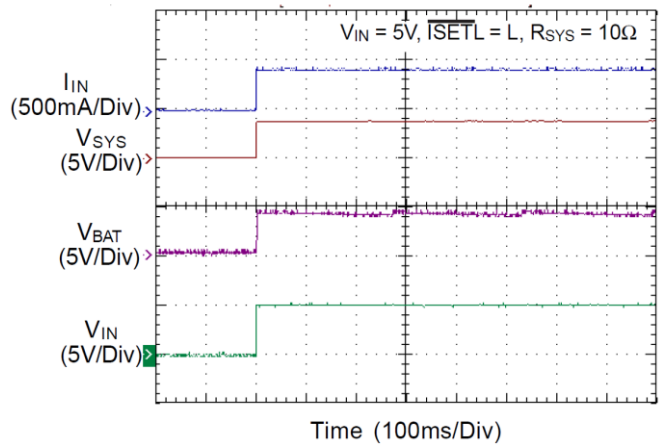

V_{IN} Hot-Plug With Battery

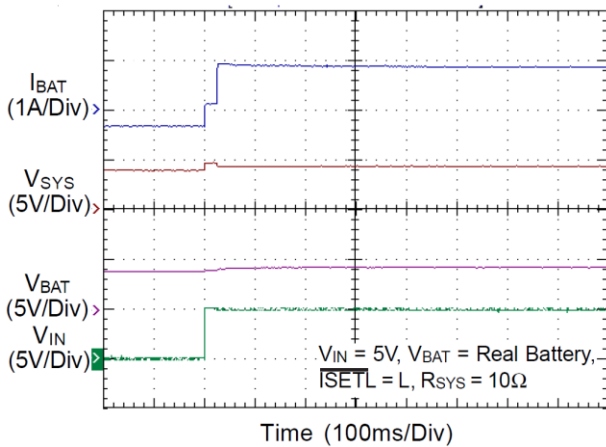

System Regulation Voltage vs. Temperature

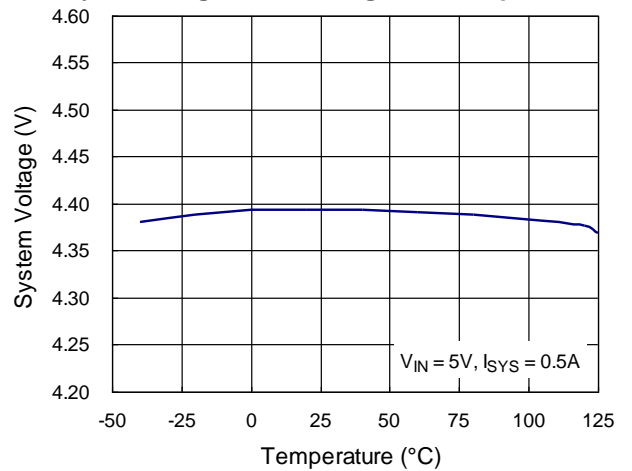

V_{IN} Over Voltage Protection

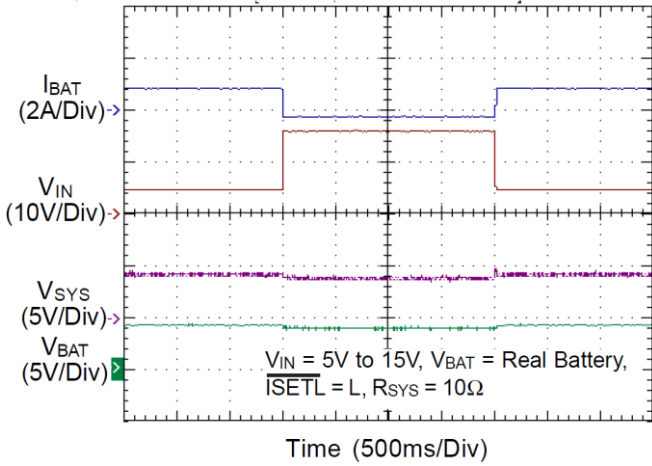

OVP Threshold Voltage vs. Temperature

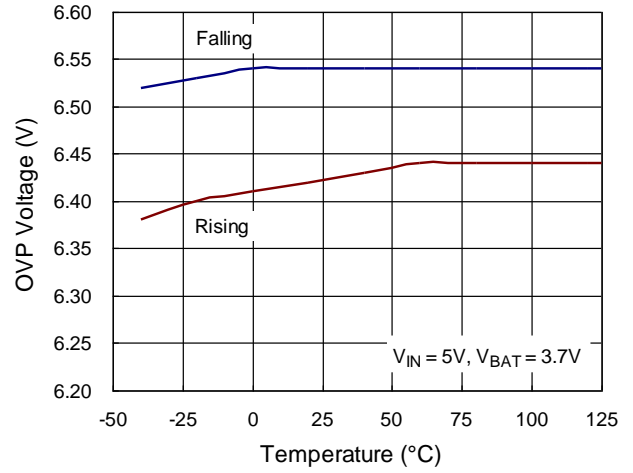

V_{IN} - V_{SYS} Dropout Voltage vs. Temperature

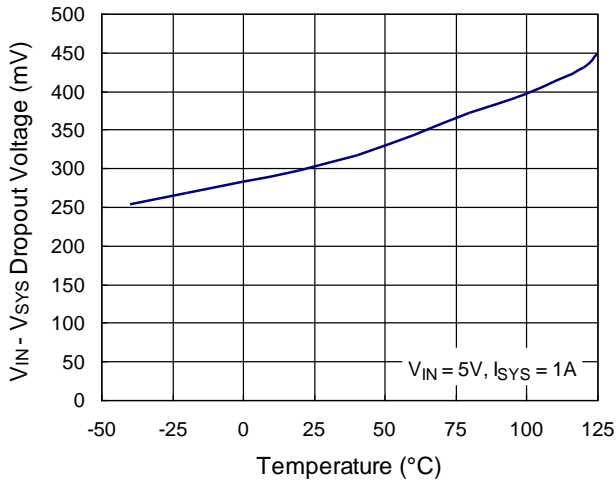

V_{BAT} - V_{SYS} Dropout Voltage vs. Temperature

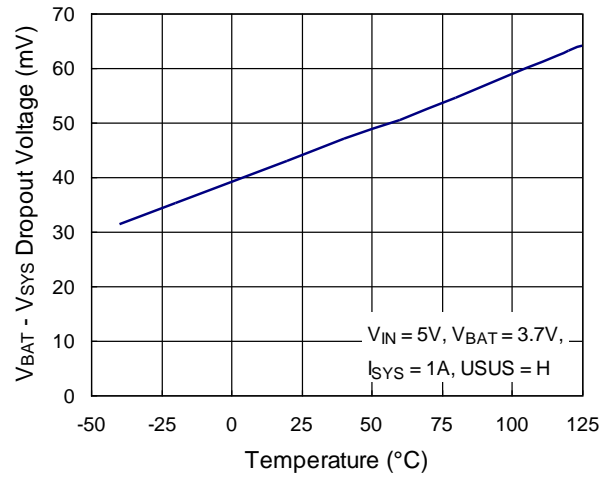

I_{CHG} Thermal Regulation vs. Temperature

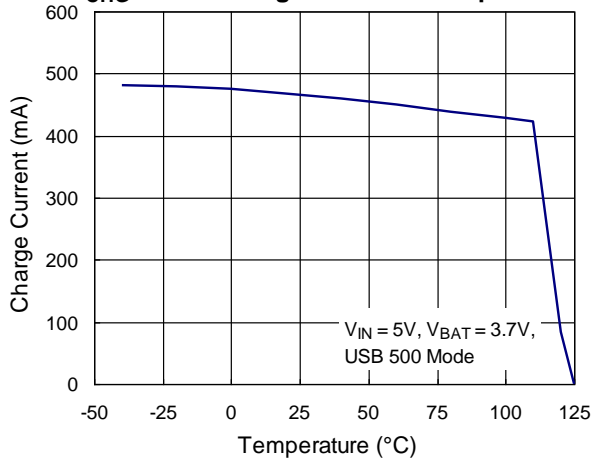

Battery Regulation Voltage vs. Temperature

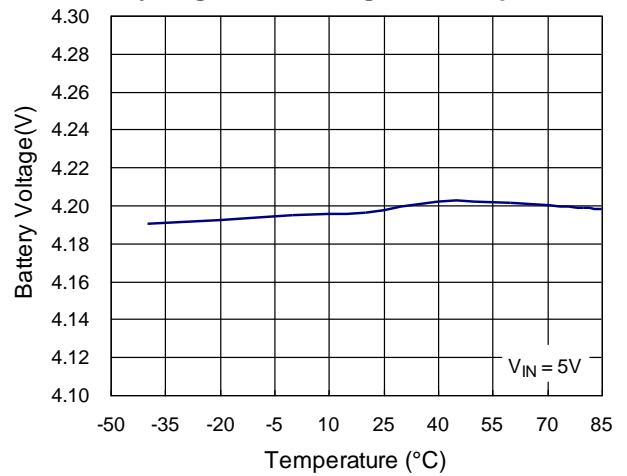

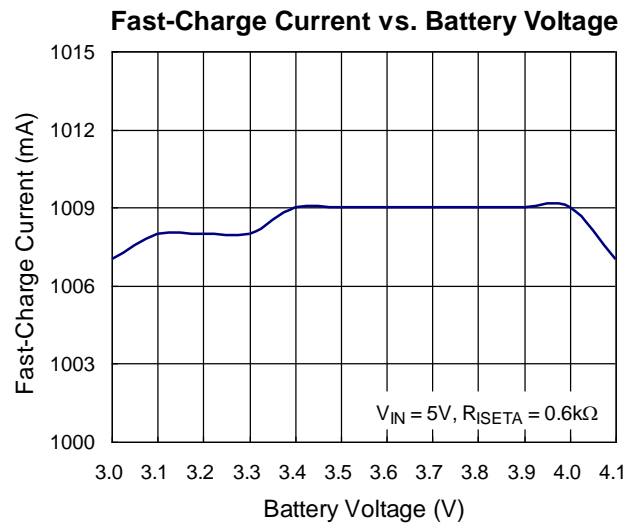
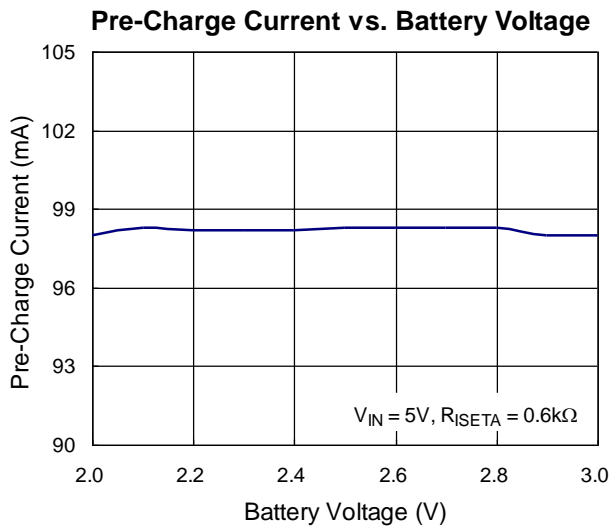

Application Information

Richtek's component specification does not include the following information in the Application Information section. Thereby no warranty is given regarding its validity and accuracy. Customers should take responsibility to verify their own designs and reserve suitable design margin to ensure the functional suitability of their components and systems.

The RT9519 is a fully integrated single-cell Li-ion battery charger ideal for portable applications. The internal thermal feedback circuitry regulates the die temperature to optimize the charge rate for all ambient temperatures. Other features include under voltage protection and over voltage protection.

Pre-charge Mode

When the output voltage is lower than 2.8V, the charging current will be reduced to a fast-charge current ratio set by R_{ISETA} to protect the battery life time.

Fast-charge Mode

When the output voltage is higher than 3V, the charging current will be equal to the fast-charge current set by R_{ISETA}.

Constant-Voltage Mode

When the output voltage is near 4.2V, and the charging current fall below the termination current, after a deglitch time check of 25ms, the charger will become disabled and CHG will go from L to H.

Re-charge Mode

When the chip is in charge termination mode, the charging current will gradually go down to zero. However, once the voltage of the battery drops to below 4.1V, there will be a deglitch time of 100ms and then the charging current will resume again.

Charging Current Decision

The charge current can be set according to the following equations :

If ISET = H (for ICHG1)

$$I_{CHG_FAST} = \frac{V_{ISETA}}{R_{ISETA}} \times 300$$

If ISET = L (for ICHG2)

$$I_{CHG_FAST} = \frac{V_{ISETA}}{R_{ISETA}} \times 150$$

$$I_{CHG_PRE} = 10\% \times I_{CHG_FAST}$$

Time Fault

During the fast charge phase, several events may increase the charging time.

For example the system load current may have activated the APPM loop which reduces the available charging current, the device has entered thermal regulation because the IC junction temperature has exceeded T_{REG}. During each of these events, if 3V < V_{BAT} < 4.1V, the internal charging time is slowed down proportionately to the reduction in charging current. However, once the duration exceeds the fault time, the CHG output will flash at approximately 2Hz to indicate a fault condition and the charge current will be reduced to about 1mA.

$$t_{FCHG_true} = t_{FCHG} \times \frac{2V}{V_{ISETA}}$$

t_{FCHG_true} : modified timer in fast

t_{FCHG} : original timer in fast charger

$$t_{FCHG} = 14400 \times \left(\frac{C_{TIMER}}{1\mu F} \right)$$

$$t_{PCHG} = \frac{t_{FCHG}}{8}$$

t_{PCHG} : timer in pre-charge

Time fault release methods :

- (1) Re-plug power
- (2) Toggle EN
- (3) Enter/exit suspend mode
- (4) Remove Battery
- (5) OVP

Note that the fast charge fault time is independent of the charge current.

Power Good

VIN Power Good ($\overline{\text{PGOOD}} = \text{L}$)

Input State	$\overline{\text{PGOOD}}$ Output
$V_{\text{IN}} < V_{\text{UVLO}}$	High Impedance
$V_{\text{UVLO}} < V_{\text{IN}} < V_{\text{BAT}} + V_{\text{OS_H}}$	High Impedance
$V_{\text{BAT}} + V_{\text{OS_H}} < V_{\text{IN}} < V_{\text{OVP}}$	Low Impedance
$V_{\text{IN}} > V_{\text{OVP}}$	High Impedance

Charge State Indicator

Charge State	$\overline{\text{CHG}}$ Output
Charging	Low(for first charge cycle)
Charging Suspended by Thermal Loop	
Safety Timers Expired	2Hz Flash
Charging Done	High Impedance
Recharging after Termination	
IC Disabled or no Valid Input Power	

Charge Enable

When EN is High, the charger turns on. When EN is low, the charger turns off. EN is pulled low at the initial condition.

VIN Input Current Limit

$\overline{\text{ISETL}}$	ISETU	VIN Input Current Limit
H	L	90mA
H	H	475mA
L	X	1.5A

Suspend Mode

Set USUS = H, and the $\overline{\text{charge}}$ will enter Suspend Mode. In the Suspend Mode, $\overline{\text{CHG}}$ is in high impedance and $I_{\text{USUS(MAX)}} < 333\mu\text{A}$.

Power Switch

For the RT9519, there are three power scenarios :

(1) When a battery and an external power supply (USB or adapter) are connected simultaneously :

If the system load requirements exceed that of the input current limit, the battery will be used to supplement the current to the load. However, if the system load requirements are less than that of the input current limit, the excess power from the external power supply will be used to charge the battery.

(2) When only the battery is connected to the system :
The battery provides the power to the system.

(3) When only an external power supply is connected to the system :

The external power supply provides the power to the system.

Input DPM Mode

For the RT9519, the input voltage is monitored when the USB100 or USB500 is selected. If the input voltage is lower than V_{DPM} , the input current limit will be reduced to stop the input voltage from dropping any further. This can prevent the IC from damaging improperly configured or inadequately designed USB sources.

APPM Mode

Once the sum of the charging and system load currents becomes higher than the maximum input current limit, the SYS pin voltage will be reduced. When the SYS pin voltage is reduced to V_{APPM} , the RT9519 will automatically operate in APPM mode. In this mode, the charging current is reduced while the SYS current is increased to maintain system output. In APPM mode, the battery termination function is disabled.

Battery Supplement Mode Short Circuit Protect

In APPM mode, the SYS voltage will continue to drop if the charge current is zero and the system load increases beyond the input current limit. When the SYS voltage decreases below the battery voltage, the battery will kick in to supplement the system load until the SYS voltage rises above the battery voltage.

While in supplement mode, there is no battery supplement current regulation. However, a built in short circuit protection feature is available to prevent any abnormal current situations. While the battery is supplementing the load, if the difference between the battery and SYS voltage becomes more than the short circuit threshold voltage, SYS will be disabled. After a

short circuit recovery time, t_{SHORT_R} , the counter will be restarted. In supplement mode, the battery termination function is disabled. Note that for the battery supply mode exit condition, $V_{BAT} - V_{SYS} < 0V$.

Thermal Regulation and Thermal Shutdown

The RT9519 provides a thermal regulation loop function to monitor the device temperature. If the die temperature rises above the regulation temperature, T_{REG} , the charge current will automatically be reduced to lower the die temperature. However, in certain

circumstances (such as high V_{IN} , heavy system load, etc.) even with the thermal loop in place, the die temperature may still continue to increase. In this case, if the temperature rises above the thermal shutdown threshold, T_{SD} , the internal switch between V_{IN} and SYS will be turned off. The switch between the battery and SYS will remain on, however, to allow continuous battery power to the load. Once the die temperature decreases by ΔT_{SD} , the internal switch between V_{IN} and SYS will be turned on again and the device returns to normal thermal regulation.

Charging Profile

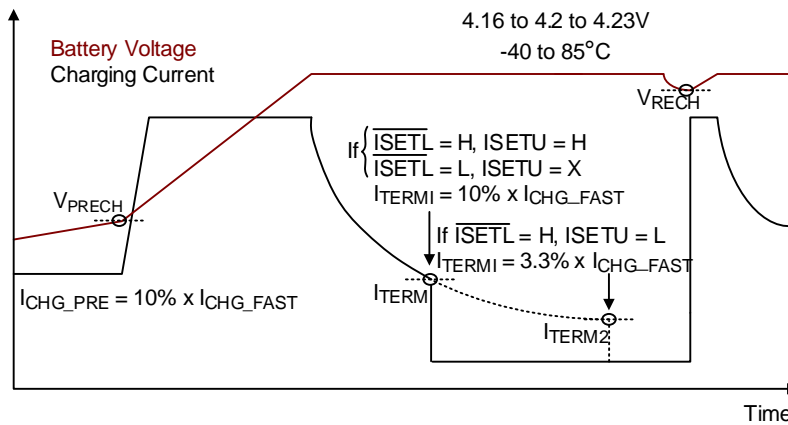

APPM Profile

1.5A Mode :

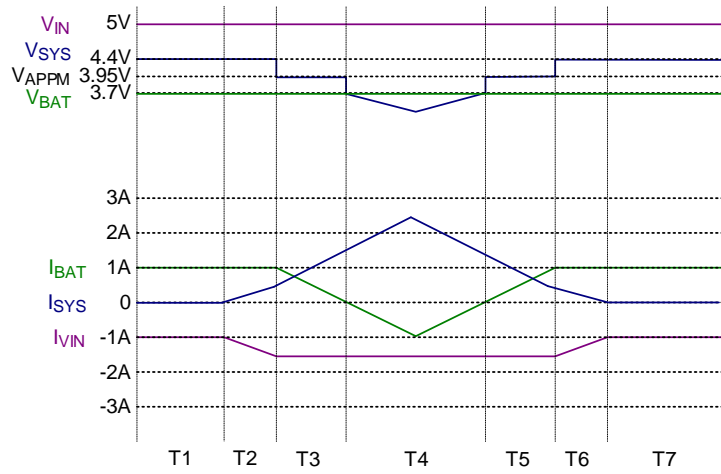

	Isys	Vsys	Ivin	IBAT
T1, T7	0	SYS Regulation Voltage	CHG_MAX	CHG_MAX
T2, T6	< Ivin_OC- CHG_MAX	SYS Regulation Voltage	Isys + CHG_MAX	CHG_MAX
T3, T5	> Ivin_OC- CHG_MAX < Ivin_OC	Auto Charge Voltage Threshold	Vin_OC	Vin_OC-Isys
T4	> Ivin_OC	Vbat-IBAT x Rds(ON)	Vin_OC	Isys-Ivin_OC

USB 500mA Mode :

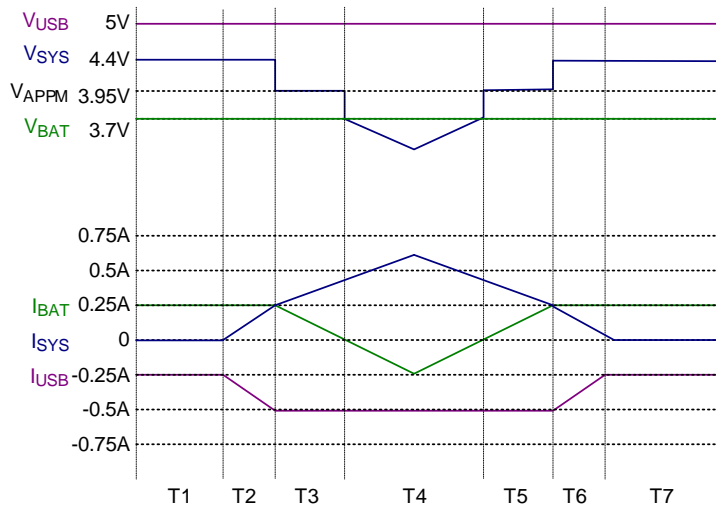

	Isys	Vsys	Iusb	IBAT
T1, T7	0	SYS Regulation Voltage	CHG_MAX	CHG_MAX
T2, T6	< Ivin_OC (USB)- CHG_MAX	SYS Regulation Voltage	Isys + CHG_MAX	CHG_MAX
T3, T5	> Ivin_OC (USB)- CHG_MAX < Ivin_OC (USB)	Auto Charge Voltage Threshold	Ivin_OC (USB)	Ivin_OC (USB)-Isys
T4	> Ivin_OC (USB)	Vbat-IBAT x Rds(ON)	Ivin_OC (USB)	Isys-Ivin_OC (USB)

VSET vs. VREG, ISET vs. ICHG

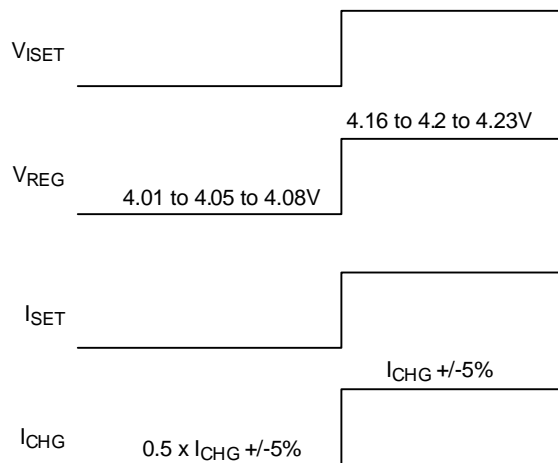

For JEITA Battery Temperature Standard :
 CV regulation voltage will change at the following battery Temp ranges
 0°C to 10°C and 45°C to 60°C
 CC regulation current will change at the following battery Temp ranges
 0°C to 10°C and 45°C to 60°C

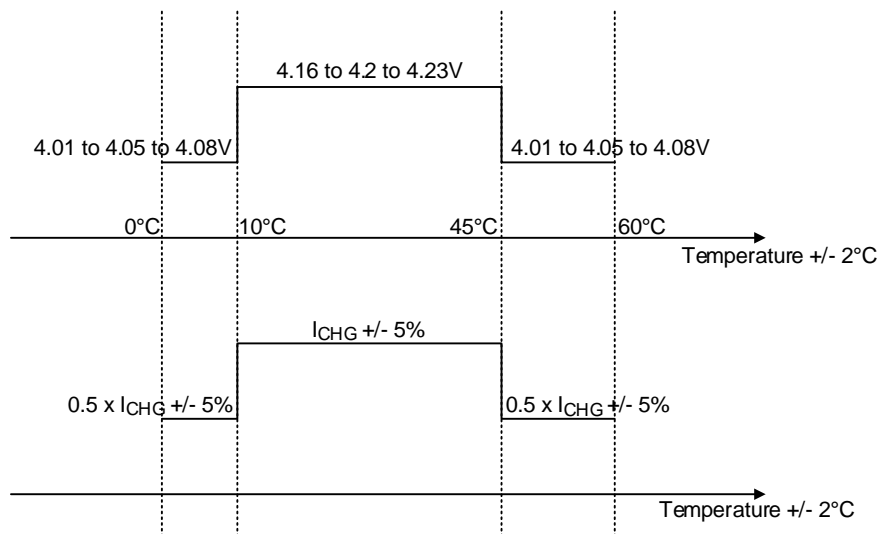

RT9519 Operation State Diagram for Charging

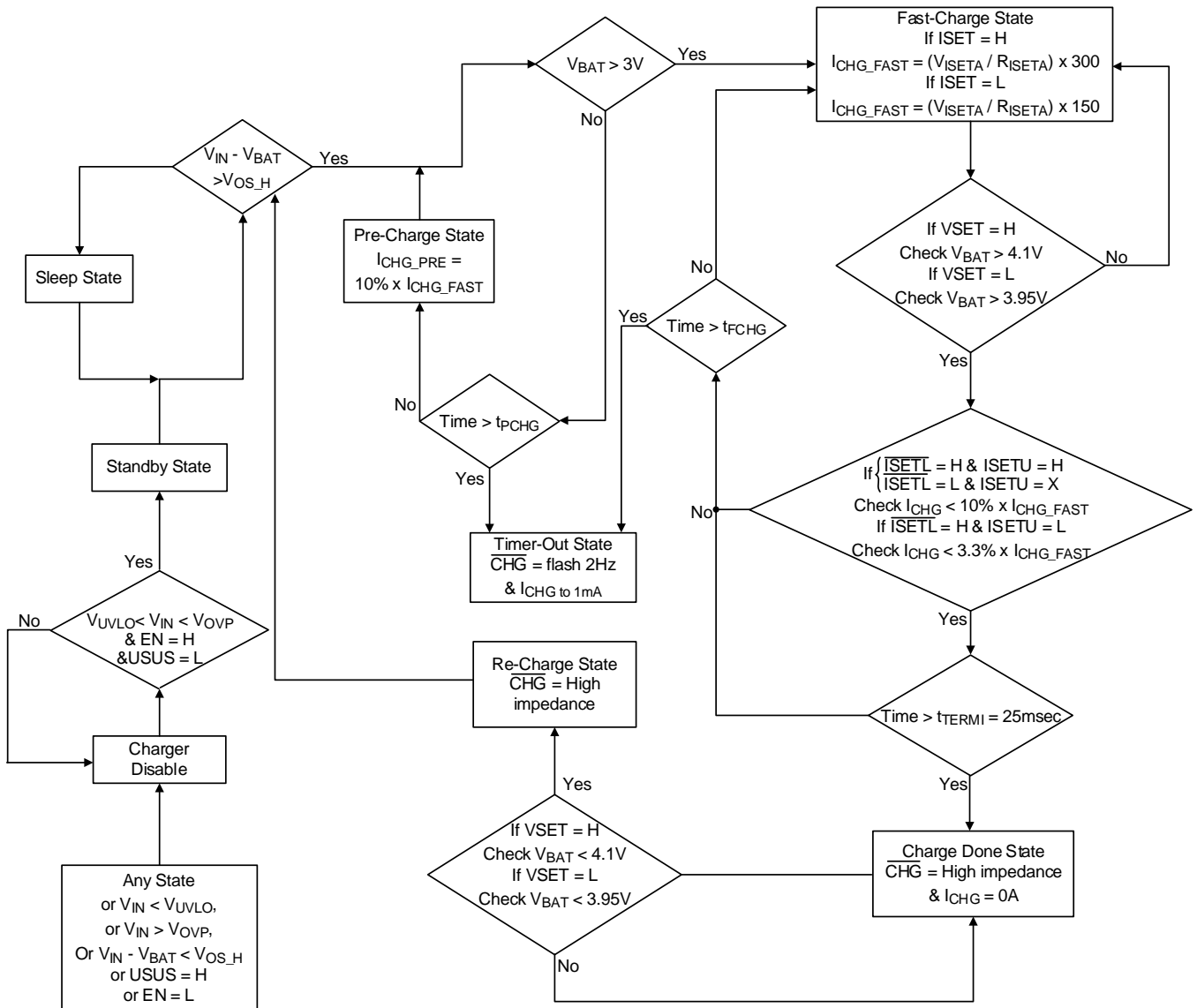

Thermal Considerations

The junction temperature should never exceed the absolute maximum junction temperature $T_{J(MAX)}$, listed under Absolute Maximum Ratings, to avoid permanent damage to the device. The maximum allowable power dissipation depends on the thermal resistance of the IC package, the PCB layout, the rate of surrounding airflow, and the difference between the junction and ambient temperatures. The maximum power dissipation can be calculated using the following formula :

$$P_{D(MAX)} = (T_{J(MAX)} - T_A) / \theta_{JA}$$

where $T_{J(MAX)}$ is the maximum junction temperature, T_A is the ambient temperature, and θ_{JA} is the junction-to-ambient thermal resistance.

For continuous operation, the maximum operating junction temperature indicated under Recommended Operating Conditions is 125°C. The junction-to-ambient thermal resistance, θ_{JA} , is highly package dependent. For a WQFN-20L 3x3 package, the thermal resistance, θ_{JA} , is 68°C/W on a standard JEDEC 51-7 high effective-thermal-conductivity four-layer test board. The maximum power dissipation at $T_A = 25^\circ\text{C}$ can be calculated as below :

$$P_{D(MAX)} = (125^\circ\text{C} - 25^\circ\text{C}) / (68^\circ\text{C/W}) = 1.471\text{W for a WQFN-20L 3x3 package.}$$

The maximum power dissipation depends on the operating ambient temperature for the fixed $T_{J(MAX)}$ and the thermal resistance, θ_{JA} . The derating curves in Figure 2 allows the designer to see the effect of rising ambient temperature on the maximum power dissipation.

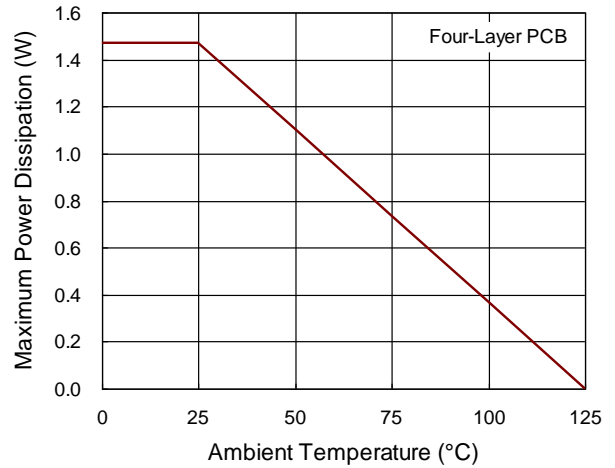
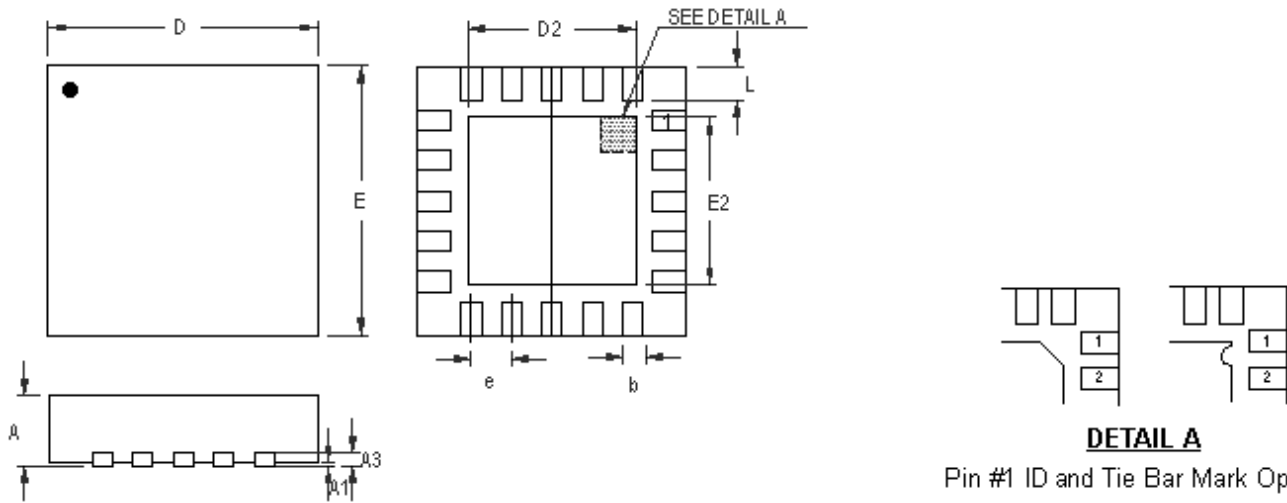

Figure 2. Derating Curves for RT9519 Package

Outline Dimension



DETAIL A
Pin #1 ID and Tie Bar Mark Options

Note : The configuration of the Pin #1 identifier is optional, but must be located within the zone indicated.

Symbol	Dimensions In Millimeters		Dimensions In Inches	
	Min	Max	Min	Max
A	0.700	0.800	0.028	0.031
A1	0.000	0.050	0.000	0.002
A3	0.175	0.250	0.007	0.010
b	0.150	0.250	0.006	0.010
D	2.900	3.100	0.114	0.122
D2	1.650	1.750	0.065	0.069
E	2.900	3.100	0.114	0.122
E2	1.650	1.750	0.065	0.069
e	0.400		0.016	
L	0.350	0.450	0.014	0.018

W-Type 20L QFN 3x3 Package

Footprint Information

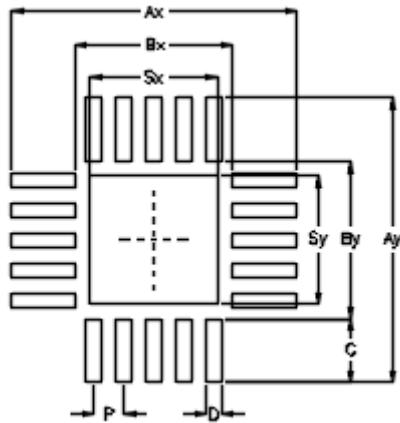

Package	Number of Pin	Footprint Dimension (mm)									Tolerance
		P	Ax	Ay	Bx	By	C	D	Sx	Sy	
V/W/U/XQFN3*3-20	20	0.40	3.80	3.80	2.10	2.10	0.85	0.20	1.70	1.70	±0.05

Packing Information

Tape and Reel Data

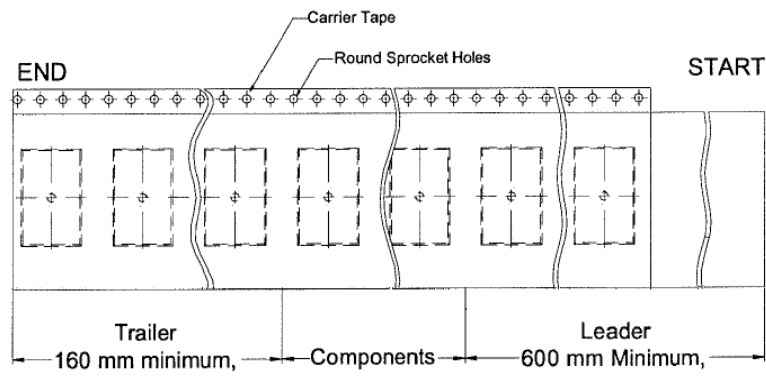
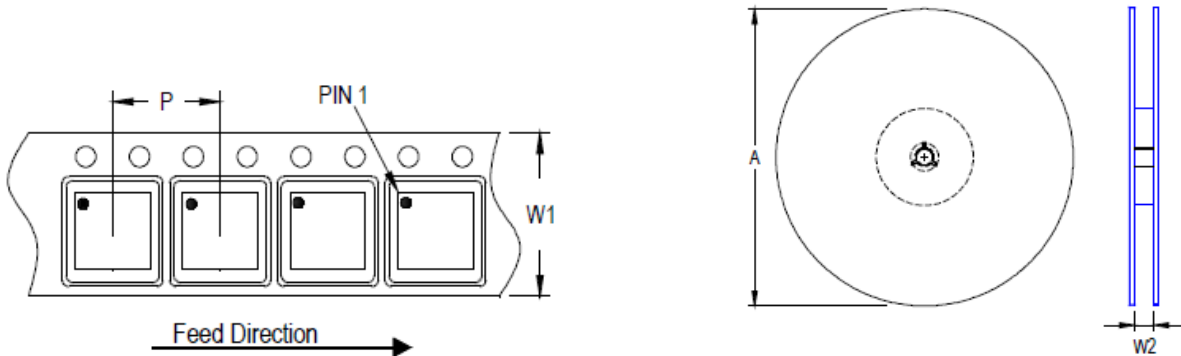



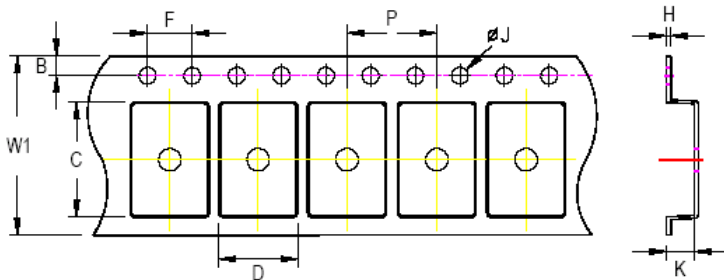



Package Type	Tape Size (W1) (mm)	Pocket Pitch (P) (mm)	Reel Size (A)		Units per Reel	Trailer (mm)	Leader (mm)	Reel Width (W2) Min./Max. (mm)
			(mm)	(in)				
QFN/DFN 3x3	12	8	180	7	1,500	160	600	12.4/14.4



C, D, and K are determined by component size.
The clearance between the components and the cavity is as follows:
- For 12mm carrier tape: 0.5mm max.

Tape Size	W1		P		B		F		ØJ		H
	Max.	Min.	Max.	Min.	Max.	Min.	Max.	Min.	Max.	Max.	
12mm	12.3mm	7.9mm	8.1mm	1.65mm	1.85mm	3.9mm	4.1mm	1.5mm	1.6mm	0.6mm	

Tape and Reel Packing

Step	Photo/Description	Step	Photo/Description
1	 <p>Reel 7"</p>	4	 <p>3 reels per inner box Box A</p>
2	 <p>HIC & Desiccant (1 Unit) inside</p>	5	 <p>12 inner boxes per outer box</p>
3	 <p>Caution label is on backside of Al bag</p>	6	 <p>Outer box Carton A</p>

Package	Reel		Box			Carton		
	Size	Units	Item	Reels	Units	Item	Boxes	Unit
QFN & DFN 3x3	7"	1,500	Box A	3	4,500	Carton A	12	54,000
			Box E	1	1,500	For Combined or Partial Reel.		

Packing Material Anti-ESD Property

Surface Resistance	Aluminum Bag	Reel	Cover tape	Carrier tape	Tube	Protection Band
Ω/cm^2	10^4 to 10^{11}	10^4 to 10^{11}	10^4 to 10^{11}	10^4 to 10^{11}	10^4 to 10^{11}	10^4 to 10^{11}

Richtek Technology Corporation

14F, No. 8, Tai Yuen 1st Street, Chupei City
 Hsinchu, Taiwan, R.O.C.
 Tel: (8863)5526789

RICHTEK

Richtek products are sold by description only. Richtek reserves the right to change the circuitry and/or specifications without notice at any time. Customers should obtain the latest relevant information and data sheets before placing orders and should verify that such information is current and complete. Richtek cannot assume responsibility for use of any circuitry other than circuitry entirely embodied in a Richtek product. Information furnished by Richtek is believed to be accurate and reliable. However, no responsibility is assumed by Richtek or its subsidiaries for its use; nor for any infringements of patents or other rights of third parties which result from its use. No license is granted by implication or otherwise under any patent or patent rights of Richtek or its subsidiaries.

Datasheet Revision History

Version	Date	Description	Item
03	2022/11/23	Modify	Electrical Characteristics on P5 Application Information on P10 Footprint Information on P18 Packing Information on P19, 20, 21
04	2023/10/2	Modify	General Description on P1 Ordering Information on P1 Electrical Characteristics on P4, 5 Application Information on P10
05	2024/2/6	Modify	Absolute Maximum Ratings on P4 Packing Information on P20