

## Dual Channel, Low Resistance Load Switch

### General Description

The RT9745A is a small, low  $R_{ON}$ , dual channel load switch with EN controlled pin. The product contains two N-MOSFETs that can operate between an input voltage range of 0.8V to 5.5V. Also, it supports a maximum continuous current of 6A each channel. Each switch is independently controlled by EN pins (EN1 and EN2), which can directly interface with low-voltage control signals.

The RT9745A is available in the WDFN-14TL 3x2 package with exposed pad for high power and heat dissipation.

### Ordering Information

RT9745A □ □

- Package Type  
QW : WDFN-14TL 3x2 (W-Type)
- Lead Plating System  
G : Green (Halogen Free and Pb Free)

Note :

Richtek products are :

- ▶ RoHS compliant and compatible with the current requirements of IPC/JEDEC J-STD-020.
- ▶ Suitable for use in SnPb or Pb-free soldering processes.

### Marking Information

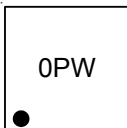

0P : Product Code  
W : Date Code

### Features

- Integrated Dual Channel Load Switch
- Input Voltage Range : 0.8V to 5.5V
- Low  $R_{ON}$  Resistance
  - ▶  $R_{ON} = 27m\Omega$  at  $V_{IN} = 5V$  ( $V_{DD} = 5V$ )
  - ▶  $R_{ON} = 27m\Omega$  at  $V_{IN} = 3.6V$  ( $V_{DD} = 5V$ )
  - ▶  $R_{ON} = 27m\Omega$  at  $V_{IN} = 1.8V$  ( $V_{DD} = 5V$ )
- 6A Maximum Continuous Switch Current Per Channel
- Low Quiescent Current
  - ▶ 75 $\mu$ A (Both Channels)
  - ▶ 55 $\mu$ A (Single Channel)
- Low Control Input Threshold Enables Use of 1.4V/1.8V/2.5V/3.3V Logics
- Configurable Rise Time
- Quick Output Discharge (QOD)
- Adaptive Discharge Current
- 14T-Lead WDFN Package with Thermal Pad

### Applications

- Ultrabook™
- Notebooks/Netbooks
- Tablet PC
- Consumer Electronics
- Set-Top Boxes/Residential Gateways
- Telecom Systems
- Solid State Drives (SSD)

### Simplified Application Circuit

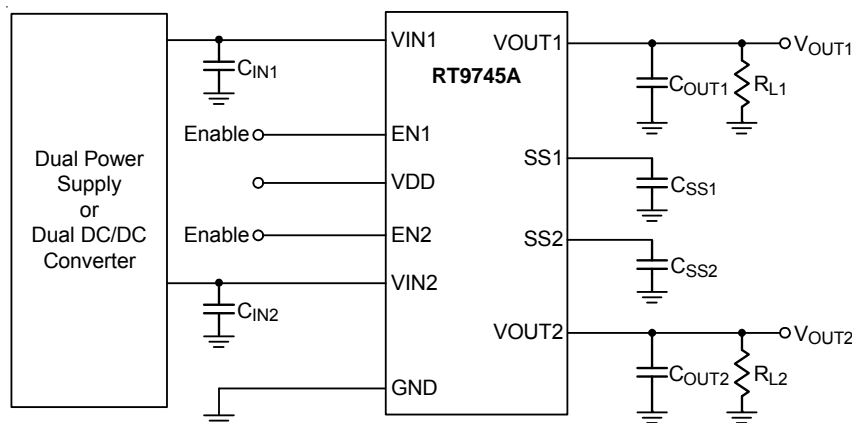

## Pin Configurations

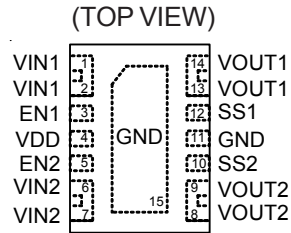

WDFN-14TL 3x2

## Functional Pin Description

Pin No.	Pin Name	Pin Function
1, 2	VIN1	Input Voltage for Switch 1. Bypass this input with a ceramic capacitor to GND. Recommended voltage range for this pin for optimal R <sub>ON</sub> performance is 0.8V to V <sub>DD</sub> .
3	EN1	Enable Control Input for Switch 1 (Active High). Do not leave floating.
4	VDD	Charge Pump Voltage Input. Power supply to the device. Recommended voltage range for this pin is 2.5V to 5.5V.
5	EN2	Enable Control Input for Switch 2 (Active High). Do not leave floating.
6, 7	VIN2	Input Voltage for Switch 2. Bypass this input with a ceramic capacitor to GND. Recommended voltage range for this pin for optimal R <sub>ON</sub> performance is 0.8V to V <sub>DD</sub> .
8, 9	VOUT2	Switch 2 Output.
10	SS2	Switch 2 Slew Rate Control. Can be left floating.
11, 15 (Exposed Pad)	GND	Ground. The Exposed pad should be soldered to a large PCB and connected to GND for maximum thermal dissipation.
12	SS1	Switch 1 Slew Rate Control. Can be left floating.
13, 14	VOUT1	Switch 1 Output.

**Function Block Diagram**

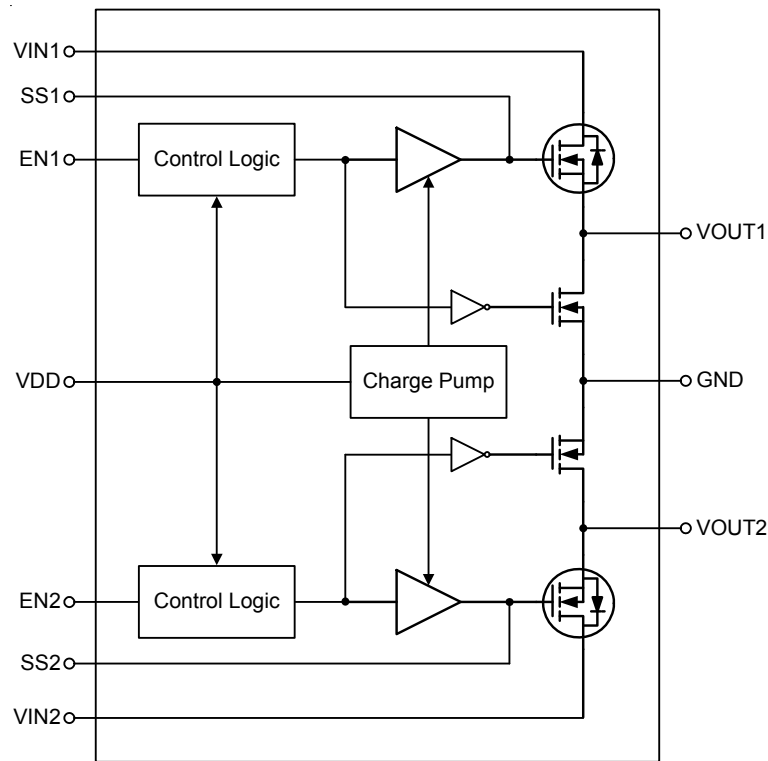

**Operation**

The RT9745A contains two N-MOSFETs which controlled by EN pin independently.

**Enable Control**

Asserting ENx pin high enables the switch. Switch will turn on as the EN signal is higher than  $V_{ENH}$ , and turn off when the EN signal is lower than  $V_{ENL}$ . Thus, it can operate under low voltage logic, please refer to the electrical characteristics. This pin cannot be left floating and must be tied either high or low voltage for proper functionality.

**Charge Pump**

Provides sufficient bias voltage to both N-MOSFETs.

**Adjustable Rise Time**

Connecting a capacitor to GND on the SSx pin sets the slew rate for each channel. It could also be used to prevent in-rush current.

## Absolute Maximum Ratings (Note 1)

• VIN1, VIN2, EN1, EN2, VDD, VOUT1, VOUT2, SS1, SS2	-----	-0.3V to 6V
• Maximum Continuous Switch Current Per Channel, IMAX	-----	6A
• Maximum Pulsed Switch Current, Pulse <300μs, 2% Duty Cycle Per Channel, IPLS	-----	8A
• Power Dissipation, PD @ TA = 25°C		
WDFN-14TL 3x2	-----	3.11W
• Package Thermal Resistance (Note 2)		
WDFN-14TL 3x2, θJA	-----	32.1°C/W
WDFN-14TL 3x2, θJC	-----	6.3°C/W
• Junction Temperature	-----	150°C
• Lead Temperature (Soldering, 10 sec.)	-----	260°C
• Storage Temperature Range	-----	-65°C to 150°C
• ESD Susceptibility (Note 3)		
HBM (Human Body Model)	-----	2kV
CDM (Charged-Device Model)	-----	1kV

## Recommended Operating Conditions (Note 4)

• VIN1,2, Input Voltage Range	-----	0.8V to VDD
• VDD, Charge Pump Input Voltage Range	-----	2.5V to 5.5V
• VEN1,2, EN Voltage Range	-----	0V to VDD
• Junction Temperature Range	-----	-40°C to 125°C
• Ambient Temperature Range	-----	-40°C to 85°C

## Electrical Characteristics

(VIN = 0.8V to 5.5V, TA = 25°C, unless otherwise specified)

Parameter	Symbol	Test Conditions	Min	Typ	Max	Unit
<b>EN Input Supply</b>						
Input Voltage	High-Level	VENH	1.4	--	5.5	V
	Low-Level	VENL	0	--	0.5	
ENx Pin Input Leakage Current	IEN	VEN = 5.5V	--	--	1	μA

(VDD = 5V, VIN = 0.8V to VDD, TA = 25°C, unless otherwise specified)

Parameter	Symbol	Test Conditions	Min	Typ	Max	Unit
<b>Power Supplies and Currents</b>						
VDD Quiescent Current (Both Channels)	IIN(VDD, ON)	IOUT1 = IOUT2 = 0A	--	75	115	μA
		VIN1,2 = VEN1,2 = VDD = 5V				
VDD Quiescent Current (Single Channel)	IIN(VDD, ON)	IOUT1 = IOUT2 = 0A	--	55	--	μA
		VIN1,2 = VEN1 = VDD = 5V, VEN2 = GND				
VDD Shutdown Current	IIN(VDD, OFF)	VEN1,2 = GND, VOUT1,2 = 0V	--	--	2	μA

Parameter	Symbol	Test Conditions	Min	Typ	Max	Unit	
V <sub>IN1,2</sub> Off-State Supply Current (Per Channel)	I <sub>IN(VIN, OFF)</sub>	V <sub>EN1,2</sub> = GND, V <sub>OUT1,2</sub> = 0V	V <sub>IN1,2</sub> = 5V	--	--	8	μA
			V <sub>IN1,2</sub> = 3.3V	--	--	3	
			V <sub>IN1,2</sub> = 1.8V	--	--	2	
			V <sub>IN1,2</sub> = 0.8V	--	--	1	
<b>Resistance Characteristics</b>							
ON-State Resistance	R <sub>ON</sub>	I <sub>OUT</sub> = -200mA, V <sub>DD</sub> = 5V	V <sub>IN</sub> = 5V	--	27	30	mΩ
			V <sub>IN</sub> = 3.3V	--	27	30	
			V <sub>IN</sub> = 1.8V	--	27	30	
			V <sub>IN</sub> = 1.5V	--	27	30	
			V <sub>IN</sub> = 1.2V	--	27	30	
			V <sub>IN</sub> = 0.8V	--	27	30	
Output Pull-down Resistance	R <sub>PD</sub>	V <sub>EN</sub> = 0V, V <sub>IN</sub> = 5V, I <sub>OUT</sub> = 15mA	--	220	300	Ω	

**Note 1.** Stresses beyond those listed “Absolute Maximum Ratings” may cause permanent damage to the device. These are stress ratings only, and functional operation of the device at these or any other conditions beyond those indicated in the operational sections of the specifications is not implied. Exposure to absolute maximum rating conditions may affect device reliability.

**Note 2.** θ<sub>JA</sub> is measured at T<sub>A</sub> = 25°C on a high effective thermal conductivity four-layer test board per JEDEC 51-7. θ<sub>JC</sub> is measured at the exposed pad of the package.

**Note 3.** Devices are ESD sensitive. Handling precaution is recommended.

**Note 4.** The device is not guaranteed to function outside its operating conditions.

Typical Application Circuit

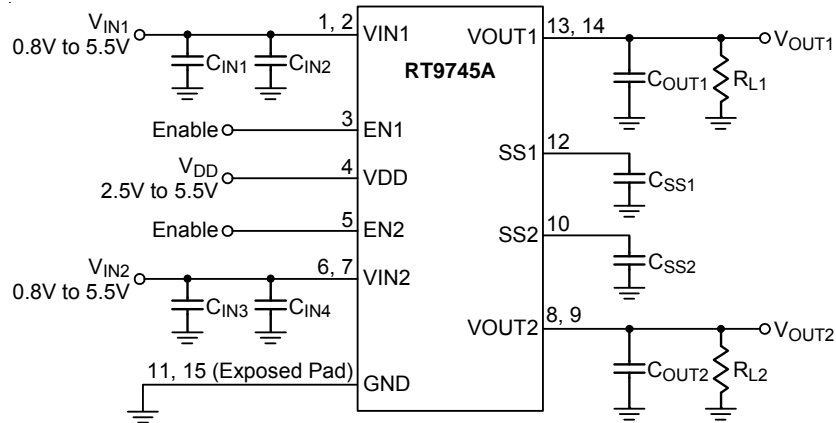

Timing Diagram

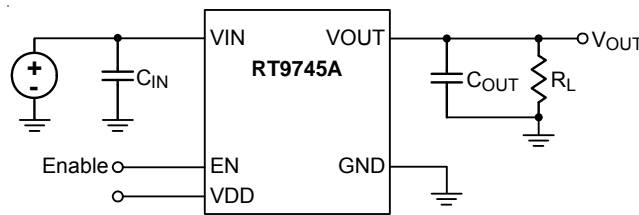

Single Channel Shown for Clarity  
TEST CIRCUIT

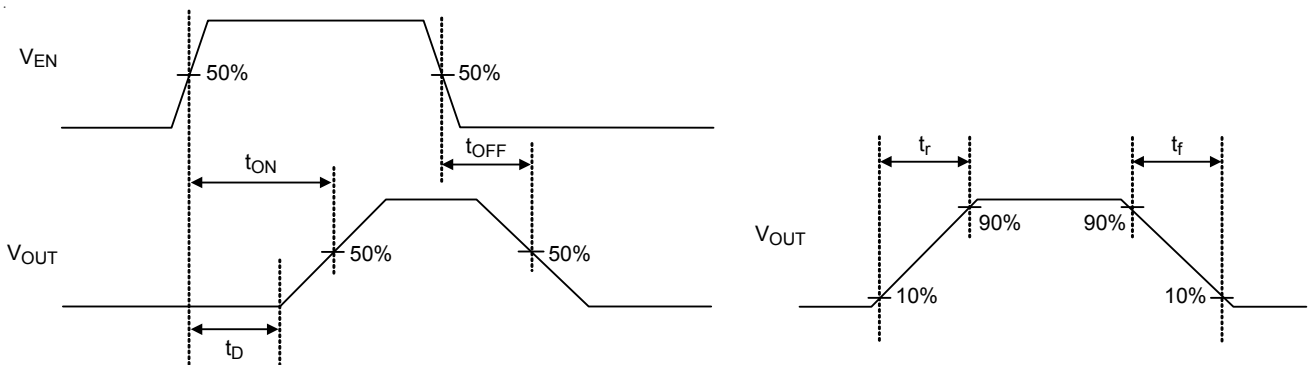
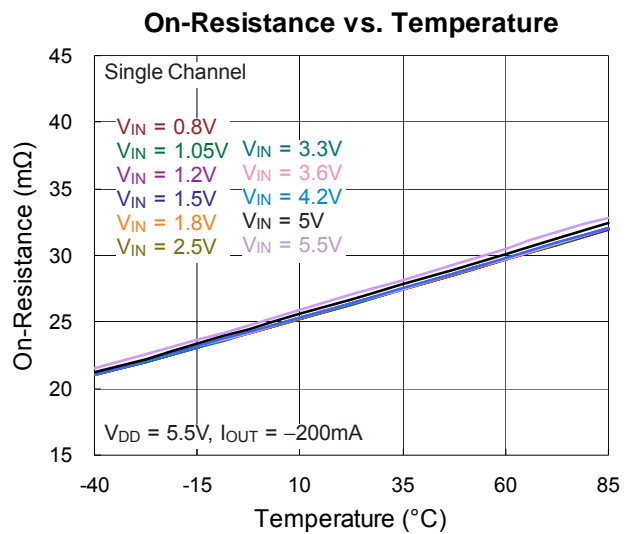
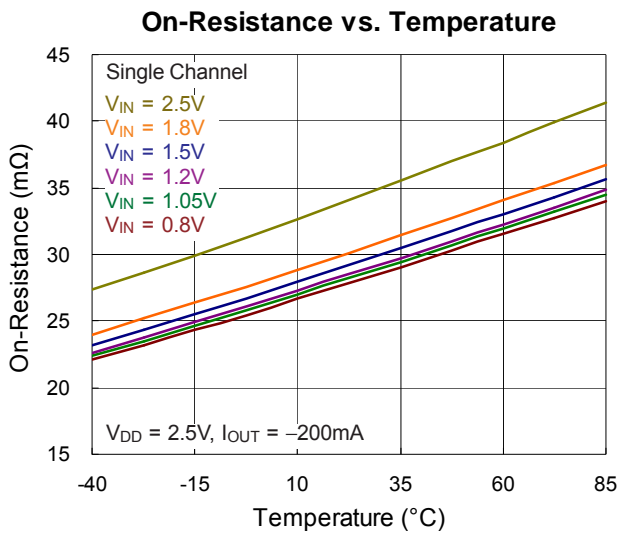
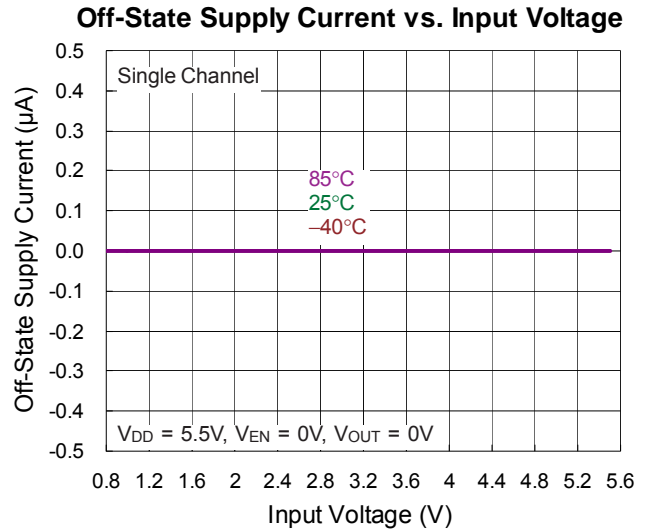
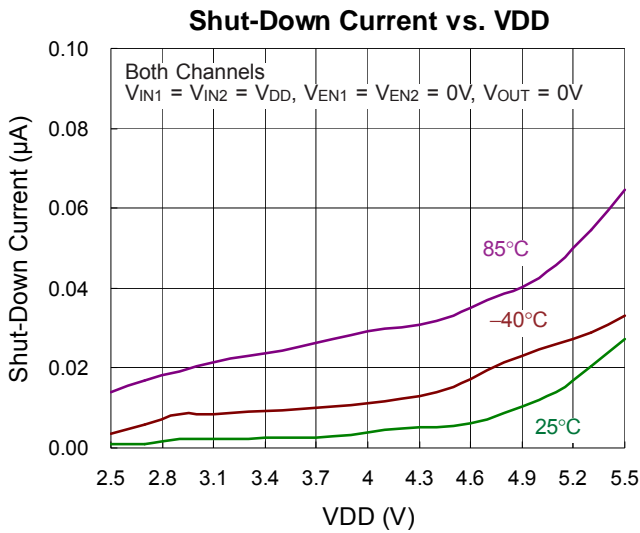
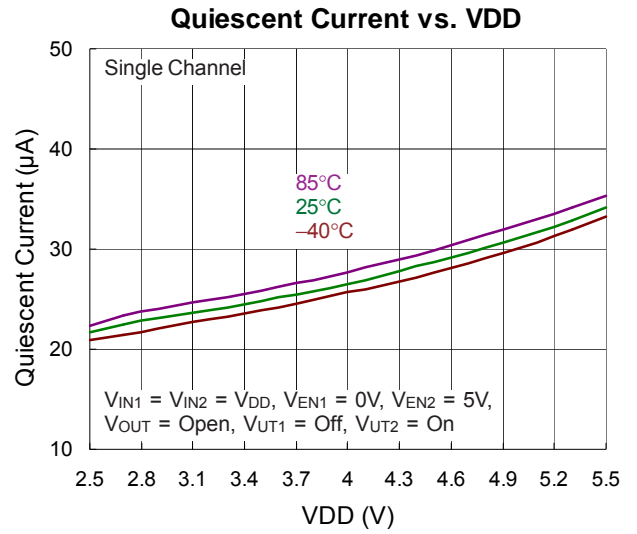
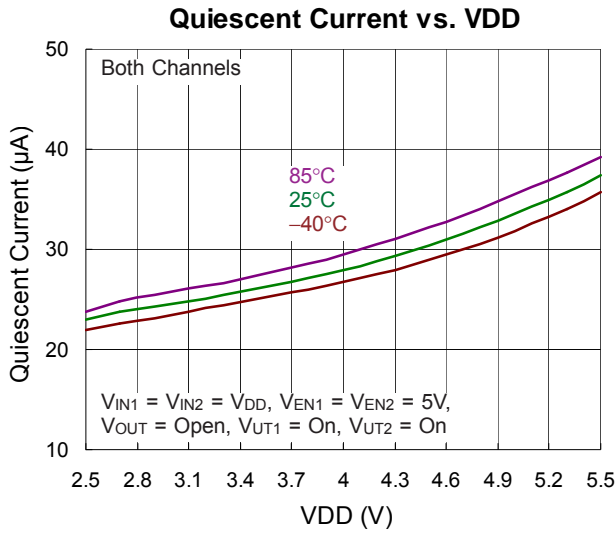

Figure 1. Test Circuit and  $t_{ON}/t_{OFF}$  Waveforms

**Timing Characteristics**

Parameter	Test Conditions	Min	Typ	Max	Unit	
VIN = EN = VDD = 5V, TA = 25°C						
T <sub>ON</sub>	Turn-On Time	R <sub>L</sub> = 10Ω, C <sub>OUT</sub> = 0.1μF, C <sub>SS</sub> = 1000pF	--	1220	--	μs
T <sub>OFF</sub>	Turn-Off Time	R <sub>L</sub> = 10Ω, C <sub>OUT</sub> = 0.1μF, C <sub>SS</sub> = 1000pF	--	4	--	
T <sub>R</sub>	VOUT Rise Time	R <sub>L</sub> = 10Ω, C <sub>OUT</sub> = 0.1μF, C <sub>SS</sub> = 1000pF	--	1350	--	
T <sub>F</sub>	VOUT Fall Time	R <sub>L</sub> = 10Ω, C <sub>OUT</sub> = 0.1μF, C <sub>SS</sub> = 1000pF	--	3	--	
T <sub>D</sub>	ON Delay Time	R <sub>L</sub> = 10Ω, C <sub>OUT</sub> = 0.1μF, C <sub>SS</sub> = 1000pF	--	400	--	
VIN = 0.8V, EN = VDD = 5V, TA = 25°C						
T <sub>ON</sub>	Turn-On Time	R <sub>L</sub> = 10Ω, C <sub>OUT</sub> = 0.1μF, C <sub>SS</sub> = 1000pF	--	580	--	μs
T <sub>OFF</sub>	Turn-Off Time	R <sub>L</sub> = 10Ω, C <sub>OUT</sub> = 0.1μF, C <sub>SS</sub> = 1000pF	--	80	--	
T <sub>R</sub>	VOUT Rise Time	R <sub>L</sub> = 10Ω, C <sub>OUT</sub> = 0.1μF, C <sub>SS</sub> = 1000pF	--	280	--	
T <sub>F</sub>	VOUT Fall Time	R <sub>L</sub> = 10Ω, C <sub>OUT</sub> = 0.1μF, C <sub>SS</sub> = 1000pF	--	20	--	
T <sub>D</sub>	ON Delay Time	R <sub>L</sub> = 10Ω, C <sub>OUT</sub> = 0.1μF, C <sub>SS</sub> = 1000pF	--	400	--	
VIN = EN = VDD = 3.3V, TA = 25°C						
T <sub>ON</sub>	Turn-On Time	R <sub>L</sub> = 10Ω, C <sub>OUT</sub> = 0.1μF, C <sub>SS</sub> = 1000pF	--	960	--	μs
T <sub>OFF</sub>	Turn-Off Time	R <sub>L</sub> = 10Ω, C <sub>OUT</sub> = 0.1μF, C <sub>SS</sub> = 1000pF	--	6	--	
T <sub>R</sub>	VOUT Rise Time	R <sub>L</sub> = 10Ω, C <sub>OUT</sub> = 0.1μF, C <sub>SS</sub> = 1000pF	--	940	--	
T <sub>F</sub>	VOUT Fall Time	R <sub>L</sub> = 10Ω, C <sub>OUT</sub> = 0.1μF, C <sub>SS</sub> = 1000pF	--	3	--	
T <sub>D</sub>	ON Delay Time	R <sub>L</sub> = 10Ω, C <sub>OUT</sub> = 0.1μF, C <sub>SS</sub> = 1000pF	--	400	--	
VIN = 0.8V, EN = VDD = 3.3V, TA = 25°C						
T <sub>ON</sub>	Turn-On Time	R <sub>L</sub> = 10Ω, C <sub>OUT</sub> = 0.1μF, C <sub>SS</sub> = 1000pF	--	560	--	μs
T <sub>OFF</sub>	Turn-Off Time	R <sub>L</sub> = 10Ω, C <sub>OUT</sub> = 0.1μF, C <sub>SS</sub> = 1000pF	--	175	--	
T <sub>R</sub>	VOUT Rise Time	R <sub>L</sub> = 10Ω, C <sub>OUT</sub> = 0.1μF, C <sub>SS</sub> = 1000pF	--	280	--	
T <sub>F</sub>	VOUT Fall Time	R <sub>L</sub> = 10Ω, C <sub>OUT</sub> = 0.1μF, C <sub>SS</sub> = 1000pF	--	40	--	
T <sub>D</sub>	ON Delay Time	R <sub>L</sub> = 10Ω, C <sub>OUT</sub> = 0.1μF, C <sub>SS</sub> = 1000pF	--	400	--	

Typical Operating Characteristics





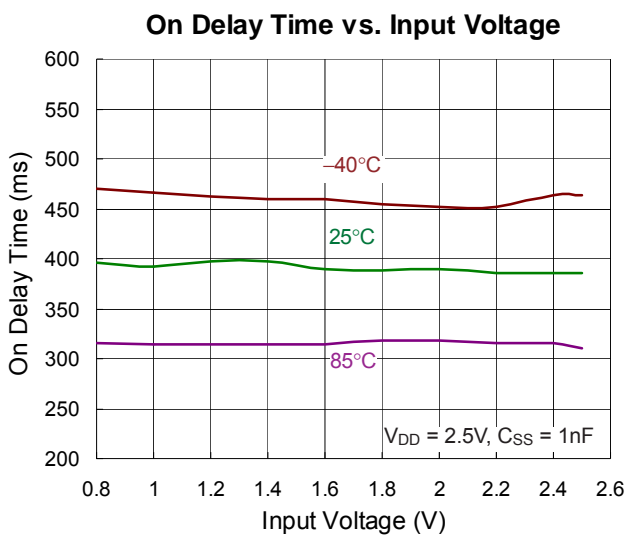
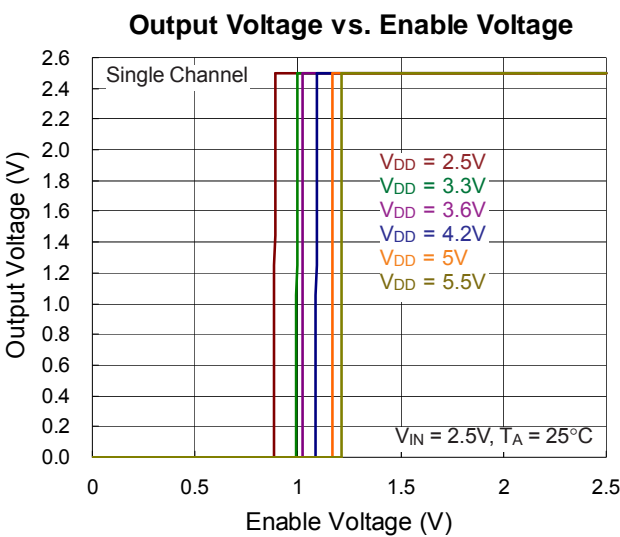
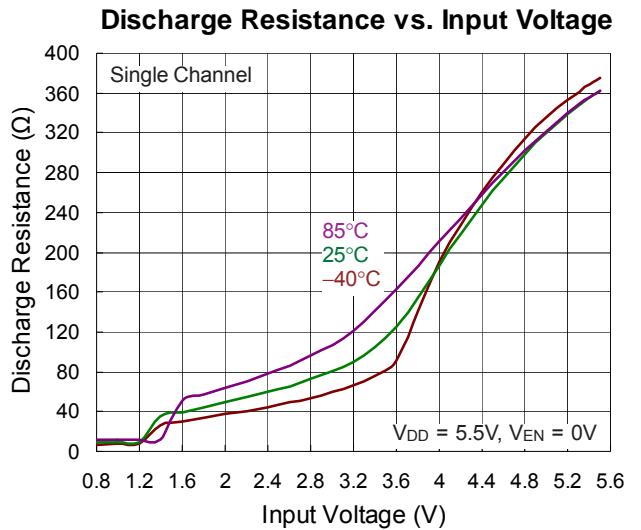
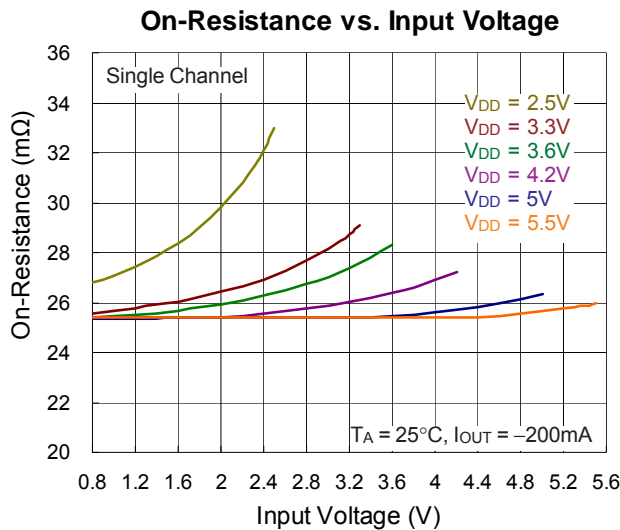
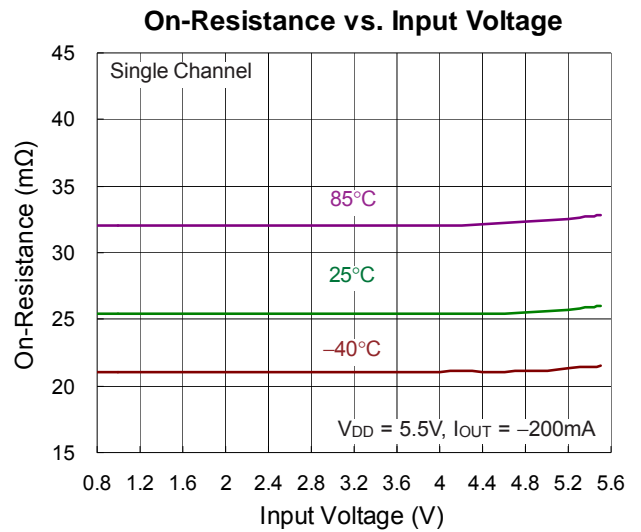
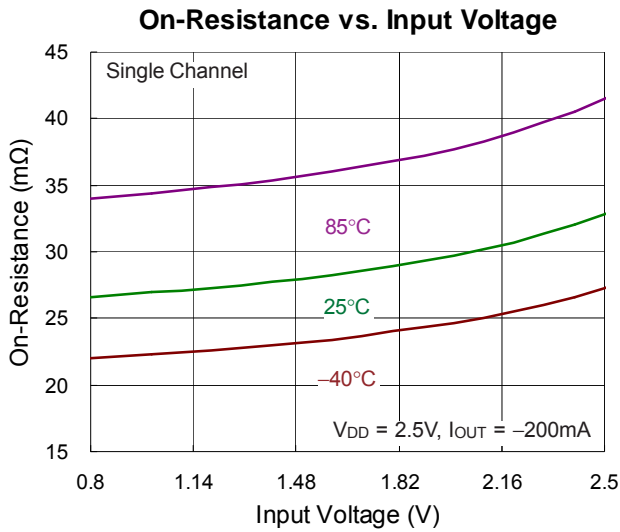

On Delay Time vs. Input Voltage

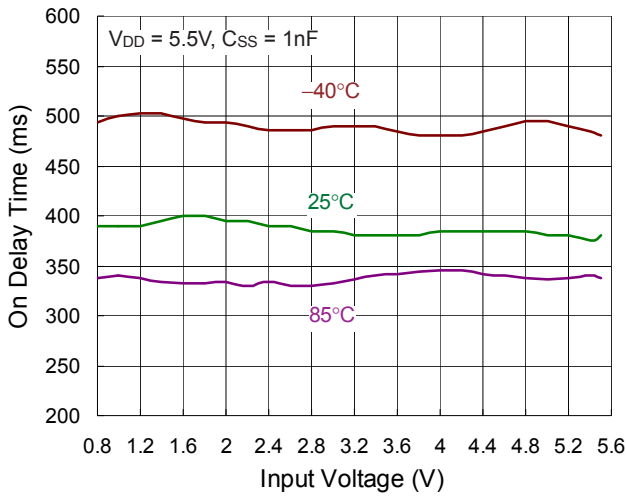

On Delay Time vs. VDD

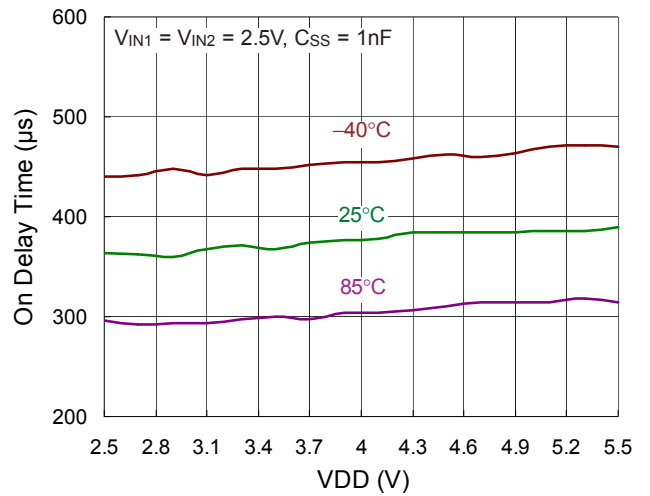

Off Fall Time vs. Input Voltage

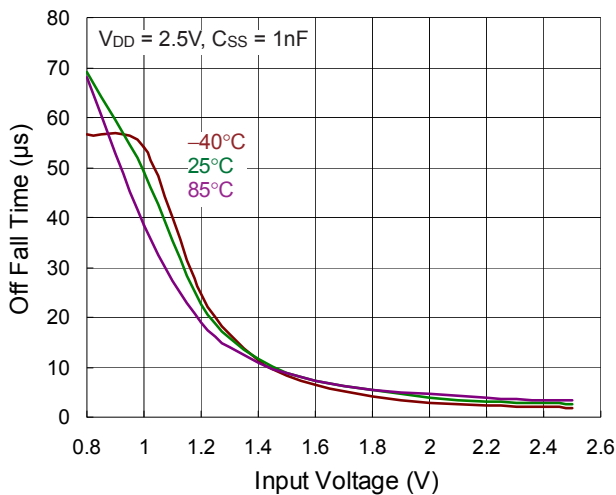

Off Fall Time vs. Input Voltage

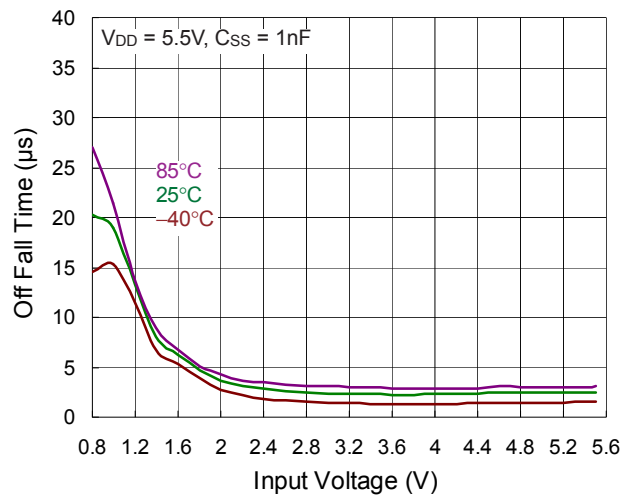

Off Fall Time vs. VDD

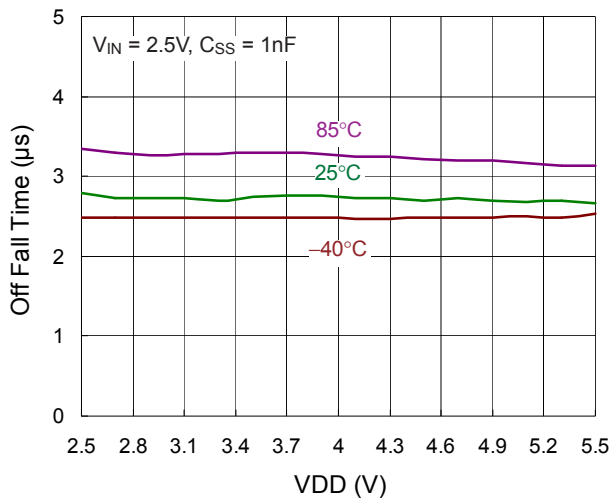

Off Time vs. Input Voltage

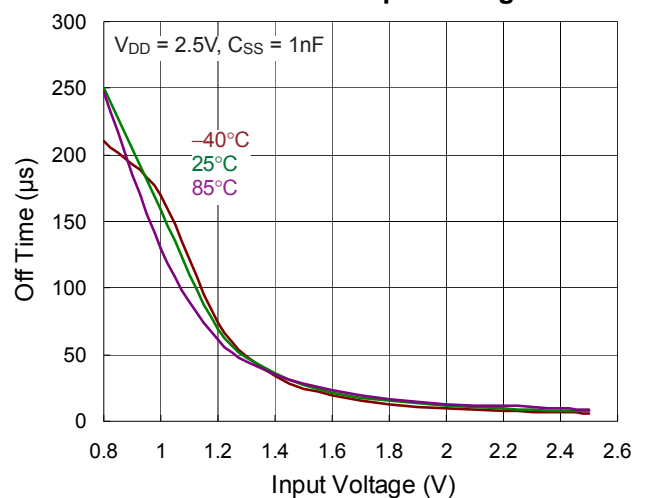

**Off Time vs. Input Voltage**

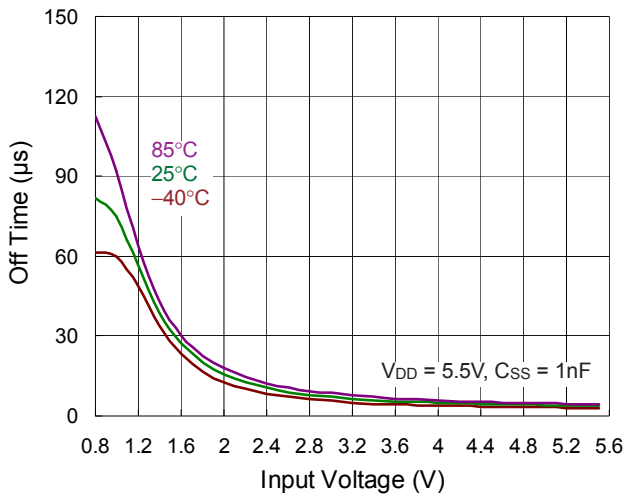

**Off Time vs. VDD**

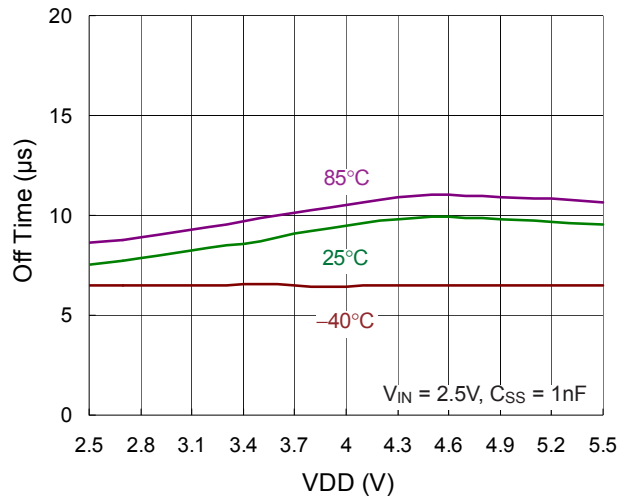

**On Time vs. Input Voltage**

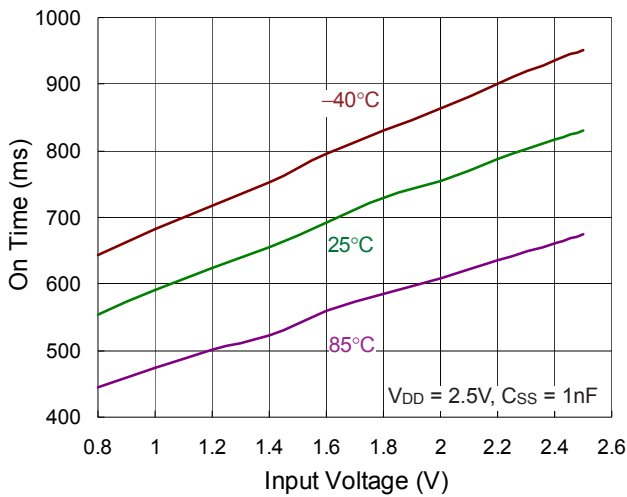

**On Time vs. Input Voltage**

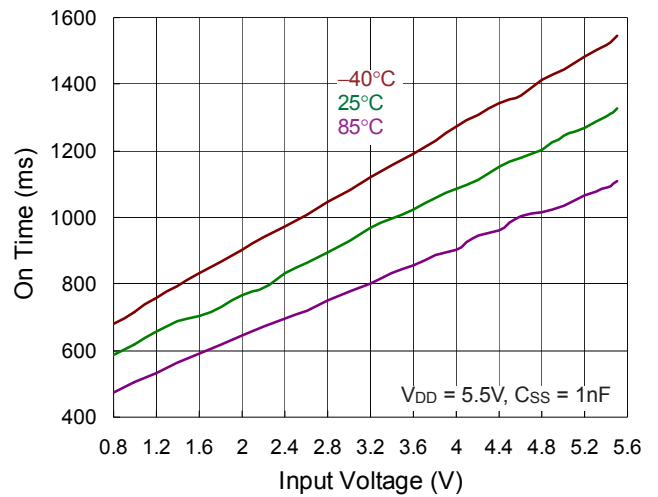

**On Time vs. VDD**

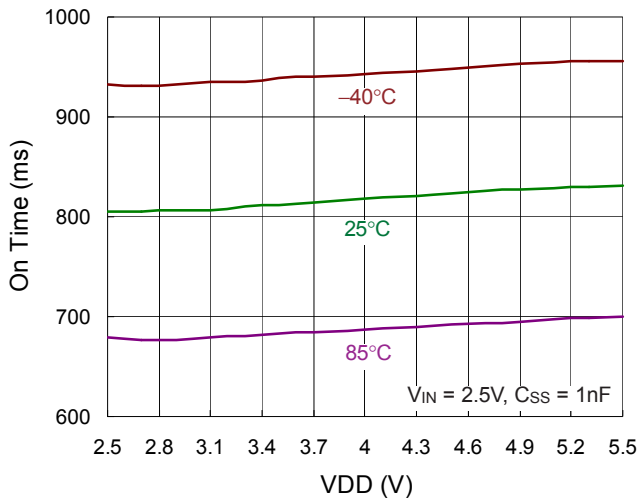

**On Rising Time vs. Input Voltage**

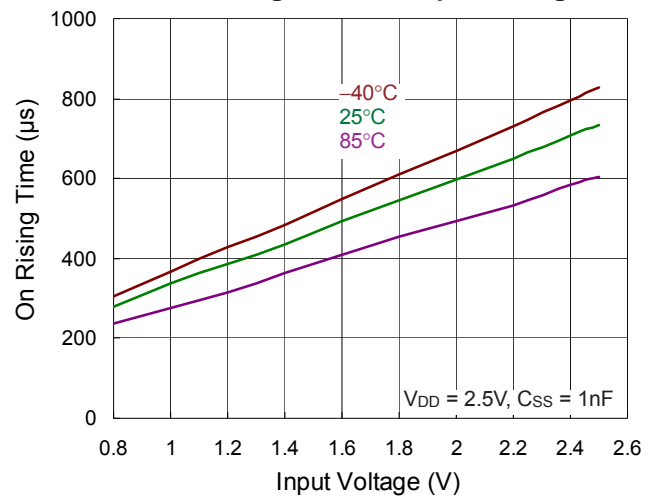

On Rising Time vs. Input Voltage

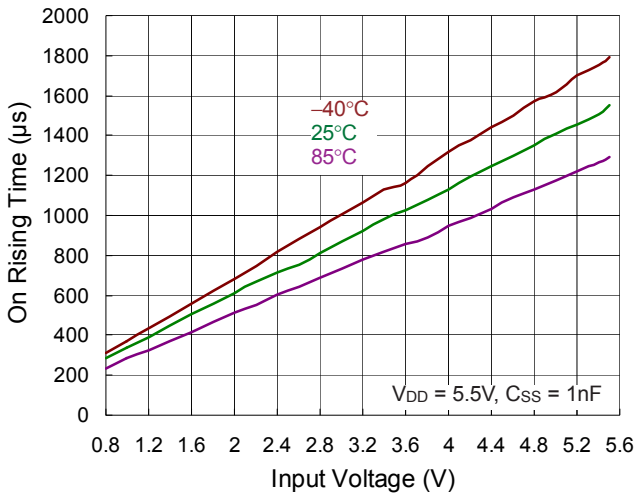

On Rising Time vs. VDD

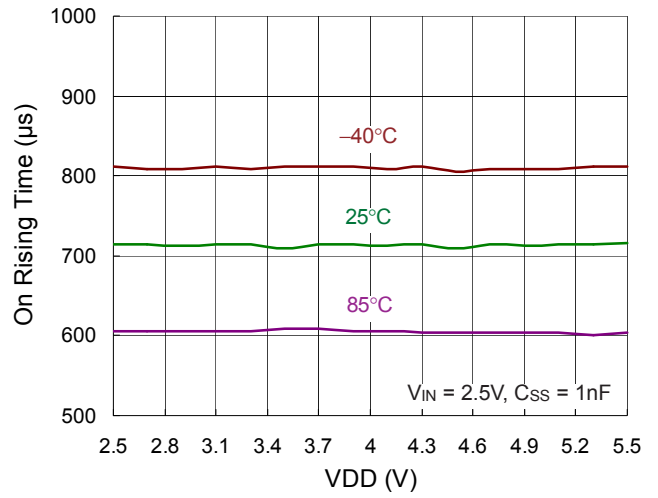

Turn-On Response Time

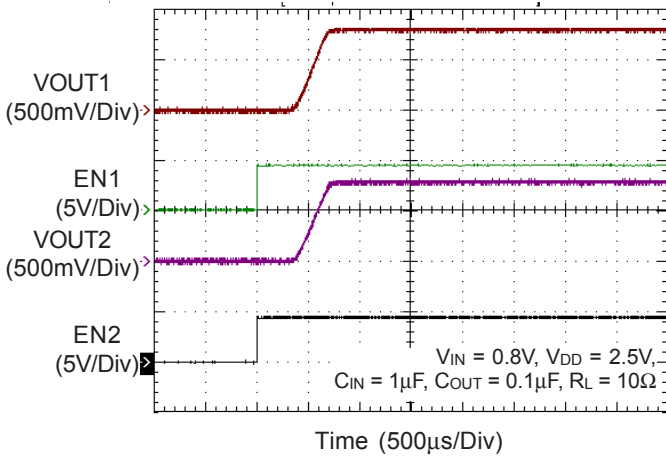

Turn-On Response Time

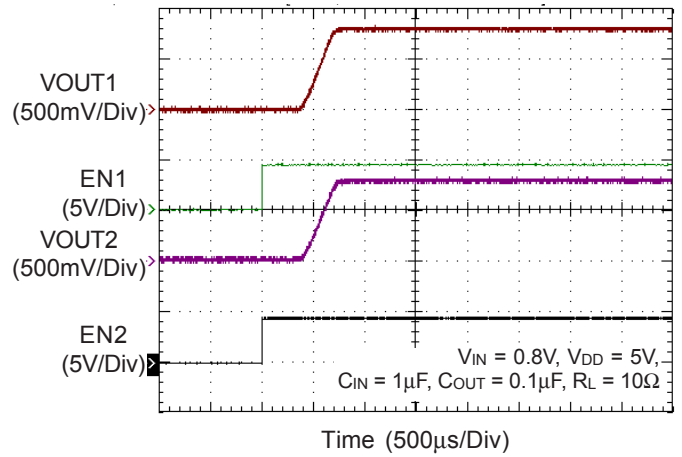

Turn-On Response Time

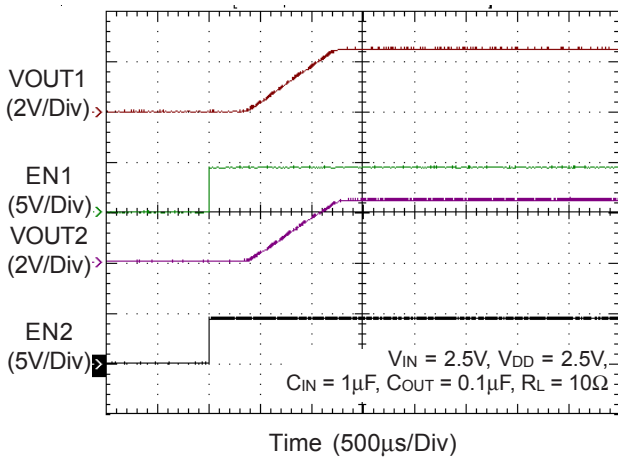

Turn-On Response Time

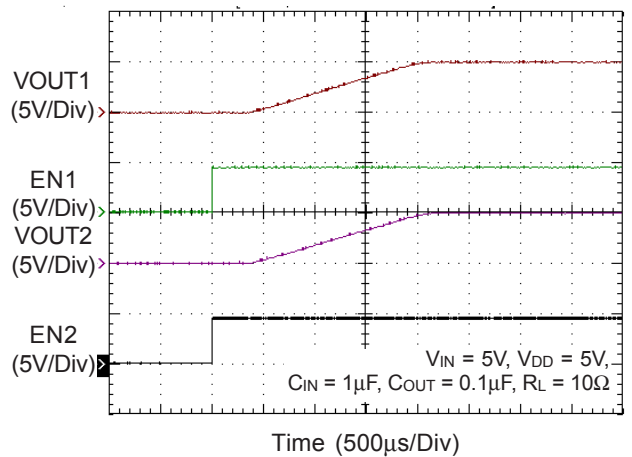

**Turn-Off Response Time**

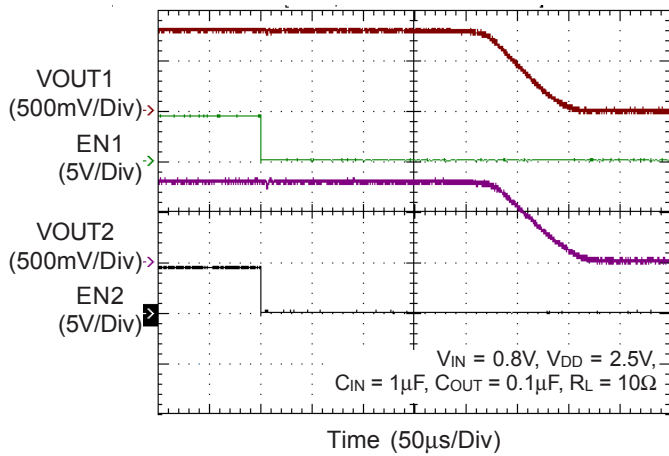

**Turn-Off Response Time**

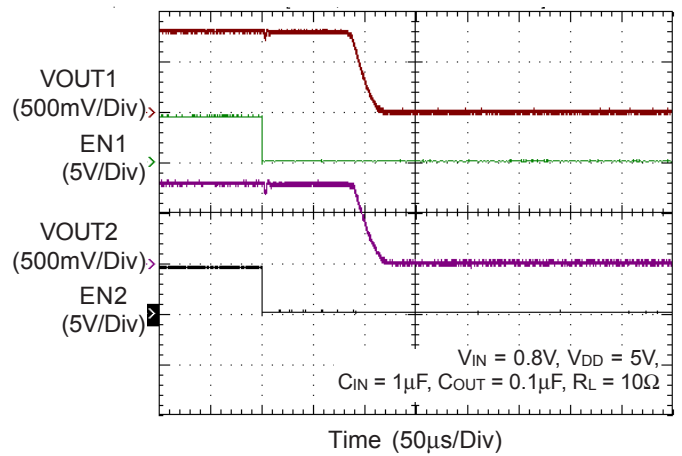

**Turn-Off Response Time**

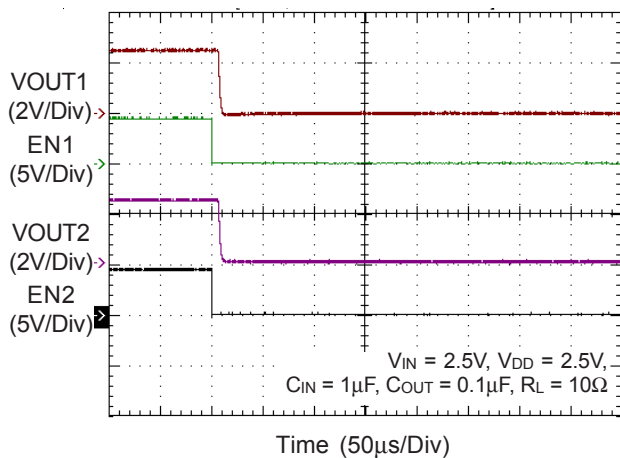

**Turn-Off Response Time**

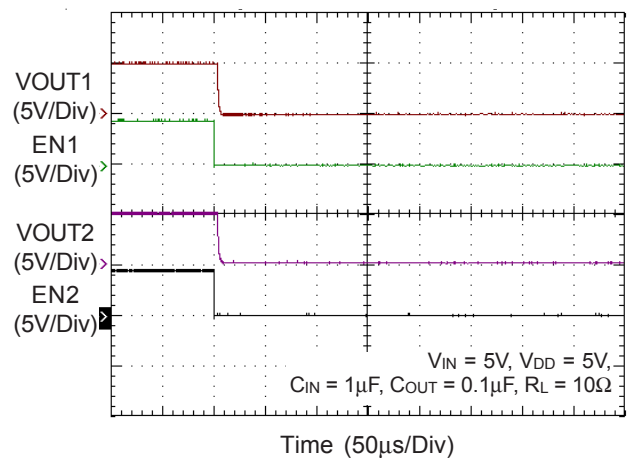

## Application Information

The RT9745A is a small, low  $R_{ON}$ , dual channel load switch with EN controlled pins, and is equipped with a charge pump circuitry to drive the internal N-MOSFET switch. The product contains two N-channel MOSFETs that can operate between input voltage range of 0.8V to 5.5V. It also supports a maximum continuous current of 6A each channel and a maximum pulsed switch current of 8A (pulse <math><300\mu s</math>). Each switch is independently controlled by EN pins (EN1 and EN2), which can directly interface with low-voltage control signals.

### Input and Output

VINx (input) is the power source connection to the internal circuitry and the Drain of the MOSFET. VOUTx (output) is the Source of the MOSFET. In a typical application, current flows through the switch from VINx to VOUTx toward the load. If VOUTx is greater than VINx, current will flow from VOUTx to VINx since the MOSFET is bidirectional when on.

### Chip Enable Input

The switch will be disabled when the ENx pin is in a logic low condition. During this condition, the internal circuitry and MOSFET will be turned off, reducing the supply current to 0.1 $\mu A$  typical. Floating the ENx may cause unpredictable operation. ENx should not be allowed to go negative with respect to GND.

### Supply Filter/Bypass Capacitor

A 1 $\mu F$  or greater low-ESR ceramic capacitor from VIN to GND, located at the device is strongly recommended to prevent the input voltage drooping during high current application. However, higher capacitor values will further reduce the voltage droop on the input. Furthermore, without the bypass capacitor, an output short may cause sufficient ringing on the input (from source lead inductance) to destroy the internal control circuitry. The input transient must not exceed 6V of the absolute maximum supply voltage even for a short duration.

### Output Filter Capacitor

A 10 to 1 ratio of supply capacitor to output capacitor from VOUTx to GND is recommended to prevent the in-rush currents during low supply voltage start-up. Because the integrated body diode in the load switch, higher output capacitor can cause output voltage to exceed supply voltage when the system supply is removed. A output capacitor smaller than supply capacitor is recommended to prevent the current flow through the integrated body diode from output to system supply.

### Charge Pump

The switch has an internal charge pump circuit that is supplied from VDD pin to afford sufficient bias voltage to both N-Channel MOSFETs. The recommended VDD voltage range is 2.5V to 5.5V, and must be above VIN for optimal low  $R_{ON}$  performance, or the value of  $R_{ON}$  will be greater than the value listed in the ELECTRICAL CHARACTERISTICS table.

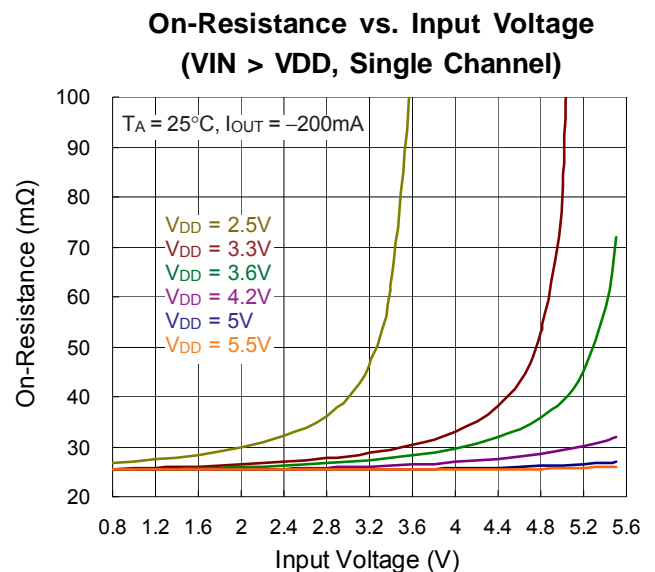

### Adjustable Rise Time

The RT9745A provides an external adjustable rise time function. The adjustable rise time is used to prevent large inrush current and output voltage overshoot while the switch is being powered-up. The external capacitor connected from SS pins to GND is charged by a 1 $\mu A$  current source to set each rise time.

**Discharge Operation**

When ENx is low, the RT9745A will discharge the system residual voltage using internal MOSFET connected between the VOUTx and GND. The discharge current depends on the voltage at the VOUTx pin. When the voltage at the VOUTx is lower than 0.8V, the RT9745A will fully turn the internal MOSFET on to pull the VOUTx low.

**Thermal Considerations**

For continuous operation, do not exceed absolute maximum junction temperature. The maximum power dissipation depends on the thermal resistance of the IC package, PCB layout, rate of surrounding airflow, and difference between junction and ambient temperature. The maximum power dissipation can be calculated by the following formula :

$$P_{D(MAX)} = (T_{J(MAX)} - T_A) / \theta_{JA}$$

where  $T_{J(MAX)}$  is the maximum junction temperature,  $T_A$  is the ambient temperature, and  $\theta_{JA}$  is the junction to ambient thermal resistance.

For recommended operating condition specifications, the maximum junction temperature is 125°C. The junction to ambient thermal resistance,  $\theta_{JA}$ , is layout dependent. For WDFN-14TL 3x2 package, the thermal resistance,  $\theta_{JA}$ , is 32.1°C/W on a standard JEDEC 51-7 four-layer thermal test board. The maximum power dissipation at  $T_A = 25^\circ\text{C}$  can be calculated by the following formula :

$$P_{D(MAX)} = (125^\circ\text{C} - 25^\circ\text{C}) / (32.1^\circ\text{C/W}) = 3.11\text{W for WDFN-14TL 3x2 package}$$

The maximum power dissipation depends on the operating ambient temperature for fixed  $T_{J(MAX)}$  and thermal resistance,  $\theta_{JA}$ . The derating curve in Figure 2 allows the designer to see the effect of rising ambient temperature on the maximum power dissipation.

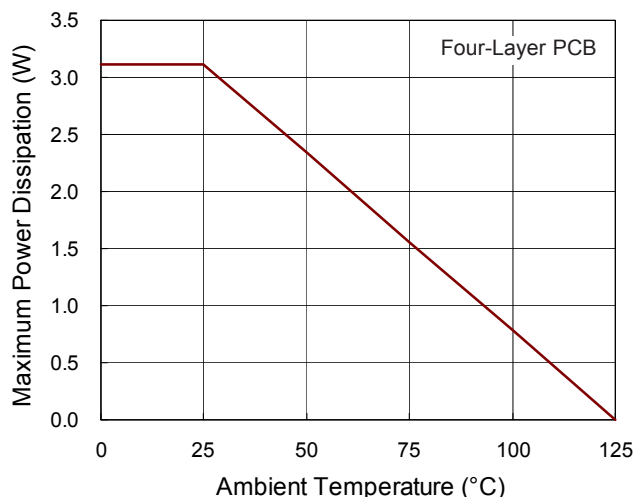
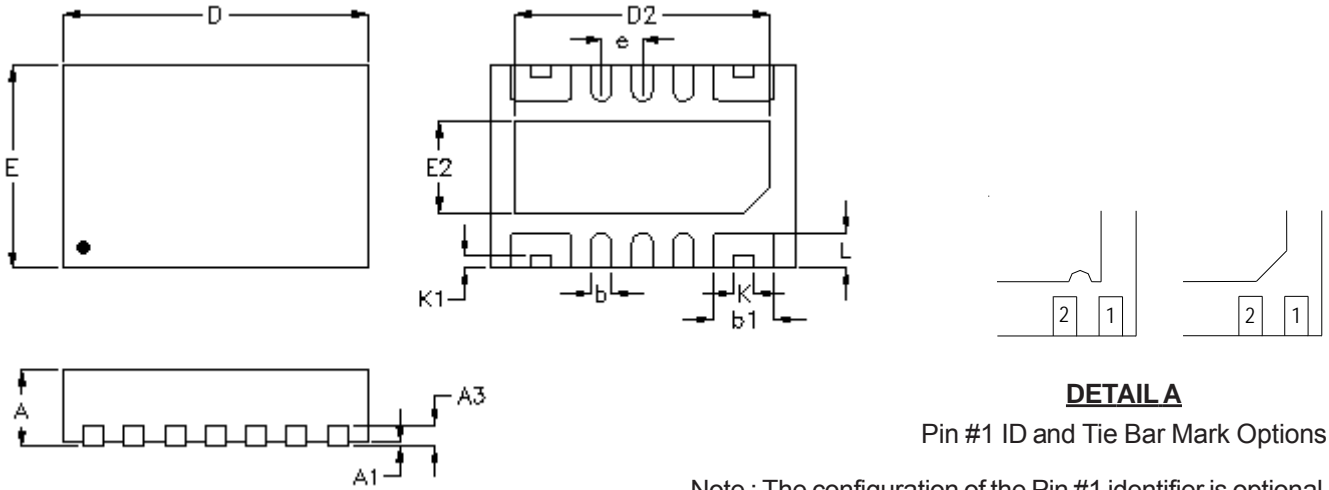

Figure 2. Derating Curve of Maximum Power Dissipation

Outline Dimension



**DETAIL A**

Pin #1 ID and Tie Bar Mark Options

Note : The configuration of the Pin #1 identifier is optional, but must be located within the zone indicated.

Symbol	Dimensions In Millimeters		Dimensions In Inches	
	Min.	Max.	Min.	Max.
A	0.700	0.800	0.028	0.031
A1	0.000	0.050	0.000	0.002
A3	0.175	0.250	0.007	0.010
b	0.150	0.250	0.006	0.010
b1	0.550	0.650	0.022	0.026
D	2.900	3.100	0.114	0.122
D2	2.450	2.550	0.096	0.100
E	1.900	2.100	0.075	0.083
E2	0.850	0.950	0.033	0.037
e	0.400		0.016	
K	0.200		0.008	
K1	0.120		0.005	
L	0.300	0.400	0.012	0.016

**W-Type 14TL DFN 3x2 Package**

**Richtek Technology Corporation**

14F, No. 8, Tai Yuen 1<sup>st</sup> Street, Chupei City  
 Hsinchu, Taiwan, R.O.C.  
 Tel: (8863)5526789

Richtek products are sold by description only. Richtek reserves the right to change the circuitry and/or specifications without notice at any time. Customers should obtain the latest relevant information and data sheets before placing orders and should verify that such information is current and complete. Richtek cannot assume responsibility for use of any circuitry other than circuitry entirely embodied in a Richtek product. Information furnished by Richtek is believed to be accurate and reliable. However, no responsibility is assumed by Richtek or its subsidiaries for its use; nor for any infringements of patents or other rights of third parties which may result from its use. No license is granted by implication or otherwise under any patent or patent rights of Richtek or its subsidiaries.