

Micro-Power Voltage Detectors with Manual Reset

General Description

The RT9816 is a micro-power voltage detector with deglitched manual reset input supervising the power supply voltage level for microprocessors (μ P) or digital systems. It provides internally fixed threshold levels with 0.1V per step ranging from 1.2V to 5V, which covers most digital applications. It features low supply current of 3 μ A. The RT9816 performs supervisory function by sending out a reset signal whenever the V_{DD} voltage falls below a preset threshold level. This reset signal will last the whole period before V_{DD} recovering. Once V_{DD} recovered upcrossing the threshold level, the reset signal will be released after a certain delay time. To pull reset signal low manually, just pull the manual reset input (MR) below the specified V_{IL} level. RT9816 is provided in SC-82 package.

Ordering Information

RT9816	□	□	□	□	
					Package Type
				Y	: SC-82
					Lead Plating System
				P	: Pb Free
				G	: Green (Halogen Free and Pb Free)
					Threshold Voltage
				12	: 1.2V
				13	: 1.3V
				:	
				49	: 4.9V
				50	: 5.0V
					Reset Active Timeout Period
				A	= 0ms ($\overline{\text{RESET}}$)
				B	= 55ms ($\overline{\text{RESET}}$)
				C	= 220ms ($\overline{\text{RESET}}$)
				D	= 450ms ($\overline{\text{RESET}}$)
				E	= 0ms (RESET)
				F	= 55ms (RESET)
				G	= 220ms (RESET)
				H	= 450ms (RESET)

Note :

Richtek products are :

- ▶ RoHS compliant and compatible with the current requirements of IPC/JEDEC J-STD-020.
- ▶ Suitable for use in SnPb or Pb-free soldering processes.

Features

- Internally Fixed Threshold 1.2V to 5V in 0.1V Step
- High Accuracy $\pm 1.5\%$
- Low Supply Current 3 μ A
- No External Components Required
- Quick Reset within 20 μ s
- Built-in Recovery Delay Include 0ms, 55ms, 220ms, 450ms Options
- 800ns Glitch Immunity of Manual Reset Input
- Low Functional Supply Voltage 0.9V
- N-Channel Open-Drain Output
- Small SC-82 Package
- RoHS Compliant and 100% Lead (Pb)-Free

Applications

- Computers
- Controllers
- Intelligent Instruments
- Critical μ P and μ C Power Monitoring
- Portable/Battery-Powered Equipment

Pin Configurations

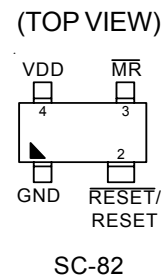

Marking Information

For marking information, contact our sales representative directly or through a Richtek distributor located in your area.

Typical Application Circuit

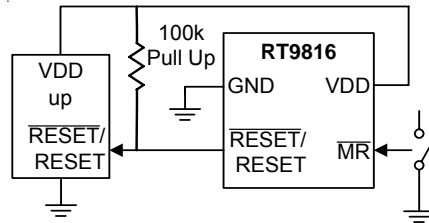

Functional Pin Description

Pin Name	Pin Function
GND	Ground.
$\overline{\text{RESET}}$	Active Low Open-Drain Reset Output.
RESET	Active High Open-Drain Reset Output.
$\overline{\text{MR}}$	Manual Reset.
VDD	Supply Voltage Input.

Function Block Diagram

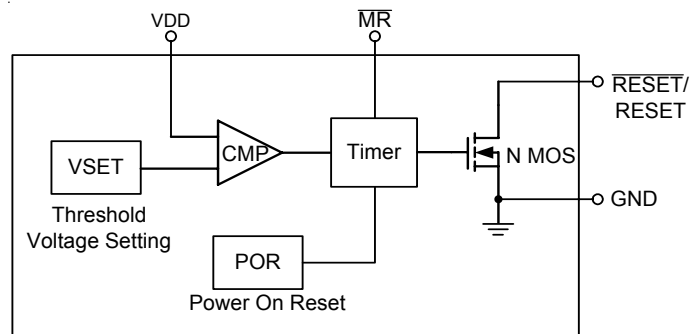

Absolute Maximum Ratings (Note 1)

- Terminal Voltage (with Respect to GND)
 V_{DD} ----- -0.3V to 6.0V
- All Other Inputs ----- -0.3V to $V_{DD}+0.3V$
- Input Current, I_{VDD} ----- 20mA
- Power Dissipation, PD @ $T_A = 25^\circ C$
 SC-82 ----- 0.25W
- Package Thermal Resistance (Note 2)
 SC-82, θ_{JA} ----- 400°C
- Lead Temperature (Soldering, 10sec.) ----- 260°C
- Storage Temperature Range ----- -65°C to 125°C
- ESD Susceptibility (Note 3)
 HBM (Human Body Model) ----- 2kV

Recommended Operating Conditions (Note 4)

- Junction Temperature Range ----- -40°C to 125°C
- Ambient Temperature Range ----- -40°C to 85°C

Electrical Characteristics

($V_{DD} = 3V$, unless otherwise specified)

Parameter	Symbol	Test Conditions	Min	Typ	Max	Unit	
Operating V_{DD} (V_{OUT}) Range	V_{DD}		0.9	--	6	V	
Supply Current	I_{DD}	$V_{TH} = 3V, V_{DD} = 4.5V, T_A = 27^\circ C$	--	3	8	μA	
Reset Threshold	V_{TH}	$T_A = 27^\circ C$	--	1.2 to 5.0	--	V	
MR Input Threshold	V_{IL}	$T_A = 27^\circ C, V_{TH} > 1.2V$	--	--	$0.25V_{DD}$	V	
	V_{IH}	$T_A = 27^\circ C, V_{TH} > 1.2V$	$0.7V_{DD}$	--	--		
MR Glitch Rejection			--	800	--	ns	
Threshold Voltage Accuracy	ΔV_{TH}	$T_A = 27^\circ C$	-1.5	--	1.5	%	
V_{DD} Drop to Reset Delay	t_{RD}	Drop = $V_{TH} - 125mV$	--	20	--	μs	
Reset Active Time Out Period	RT9816A/E	t_{RP}	$V_{DD} \geq 1.02 \times V_{TH}$	--	0	--	ms
	RT9816B/F			35	55	75	
	RT9816C/G			143	220	297	
	RT9816D/H			292	450	608	
RESET Output Voltage Low	V_{OL}	$3 = V_{DD} < V_{TH}, I_{SINK} > 3.5mA$	--	--	0.4	V	
Hysteresis Width	V_{HYS}		--	$0.01V_{TH}$	--	V	

Note 1. Stresses beyond those listed “Absolute Maximum Ratings” may cause permanent damage to the device. These are stress ratings only, and functional operation of the device at these or any other conditions beyond those indicated in the operational sections of the specifications is not implied. Exposure to absolute maximum rating conditions may affect device reliability.

Note 2. θ_{JA} is measured at $T_A = 25^\circ\text{C}$ on a low effective thermal conductivity single-layer test board per JEDEC 51-3.

Note 3. Devices are ESD sensitive. Handling precaution is recommended.

Note 4. The device is not guaranteed to function outside its operating conditions.

Typical Operating Characteristics

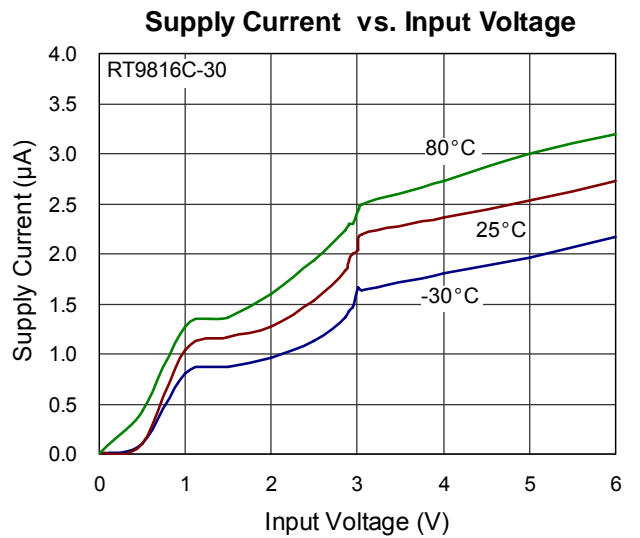
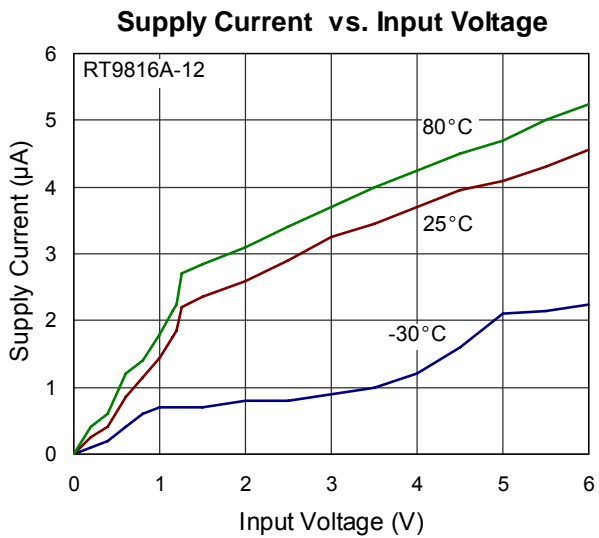
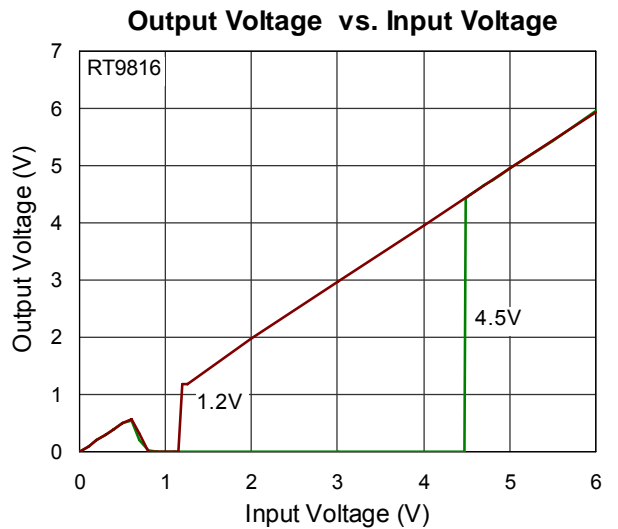
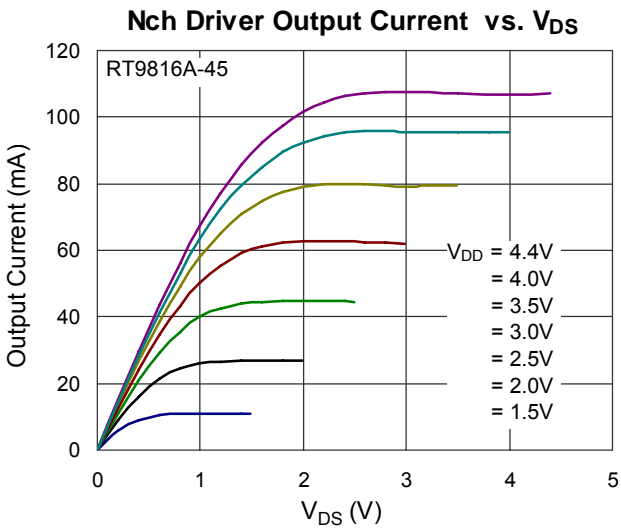
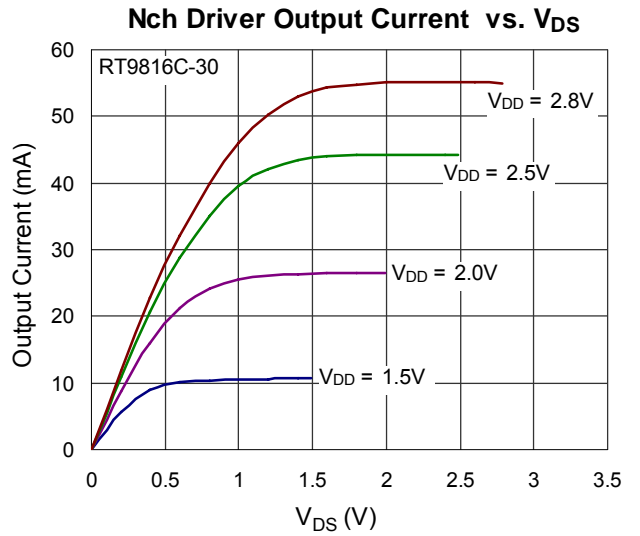
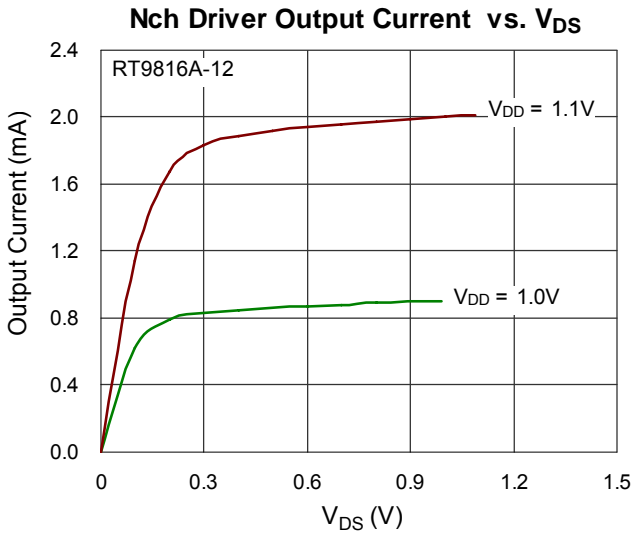

Supply Current vs. Input Voltage

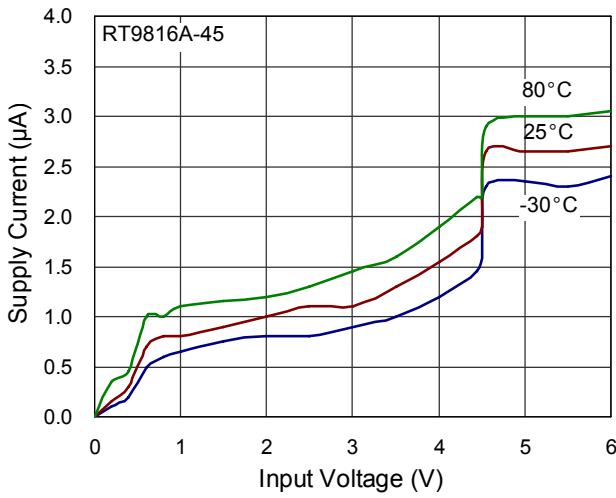

Power Down Reset Delay vs. Temperature

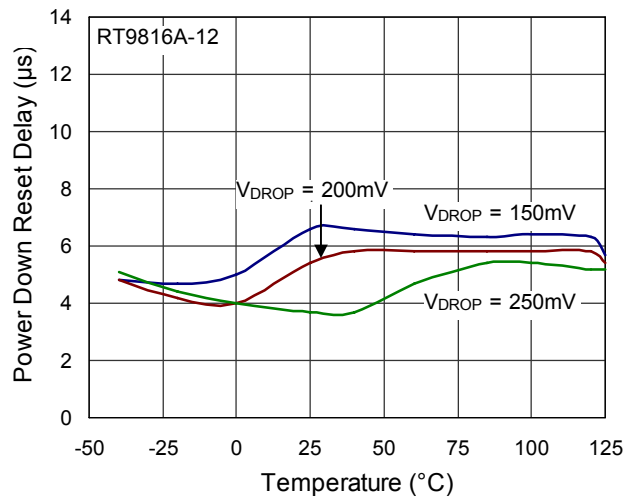

Power Down Reset Delay vs. Temperature

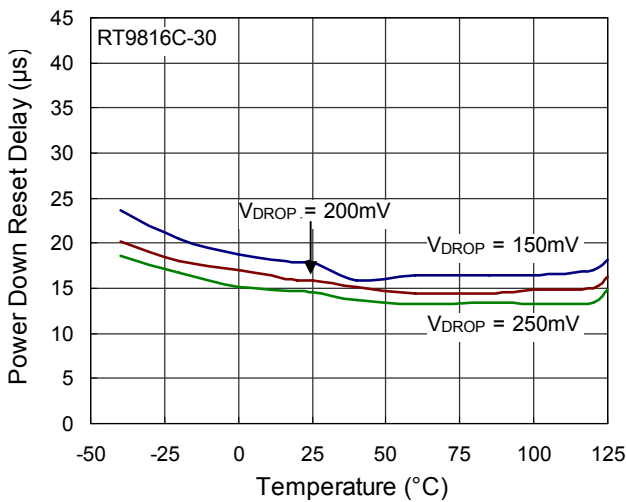

Power Down Reset Delay vs. Temperature

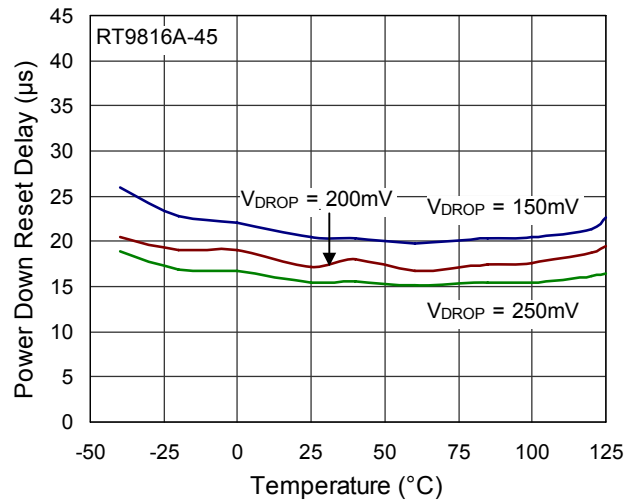

Reset Threshold Deviation vs. Temperature

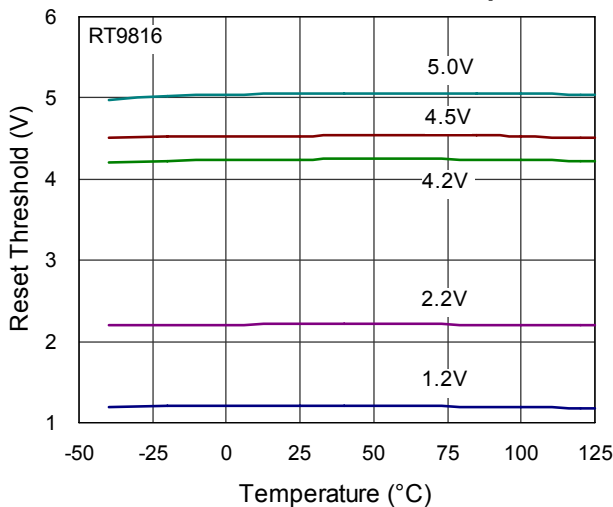

Nch Driver Sink Current vs. Input Voltage

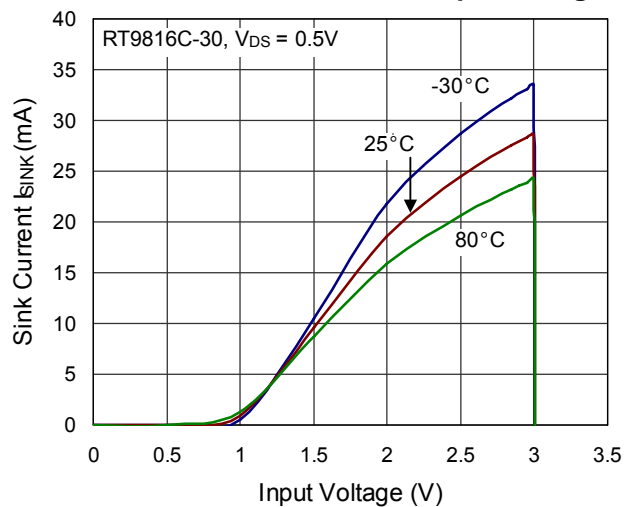

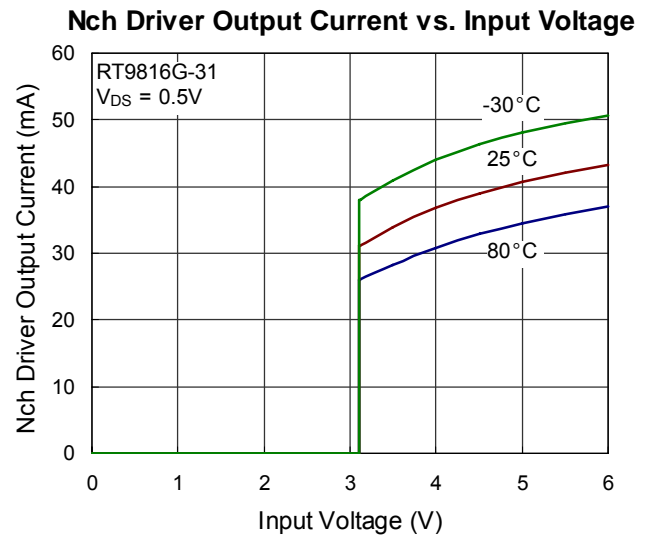
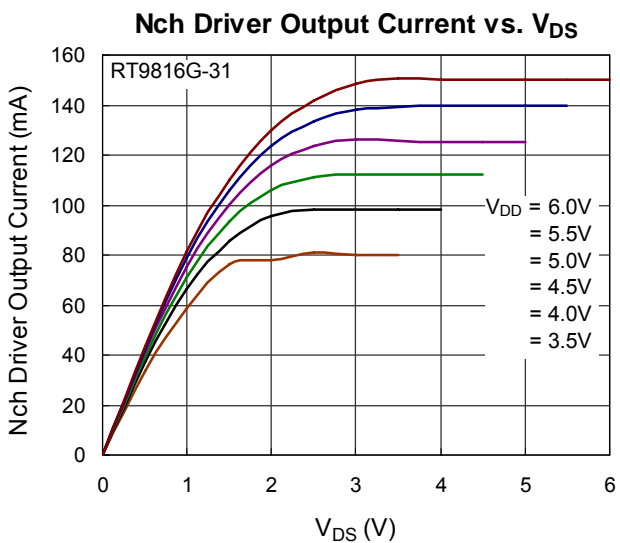
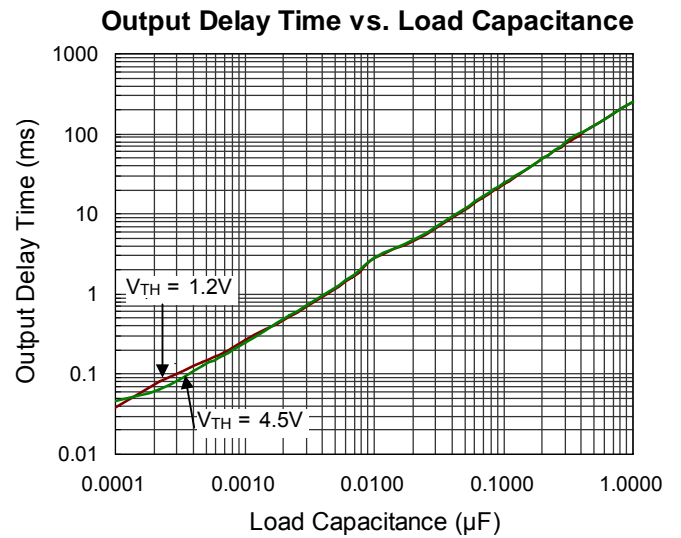
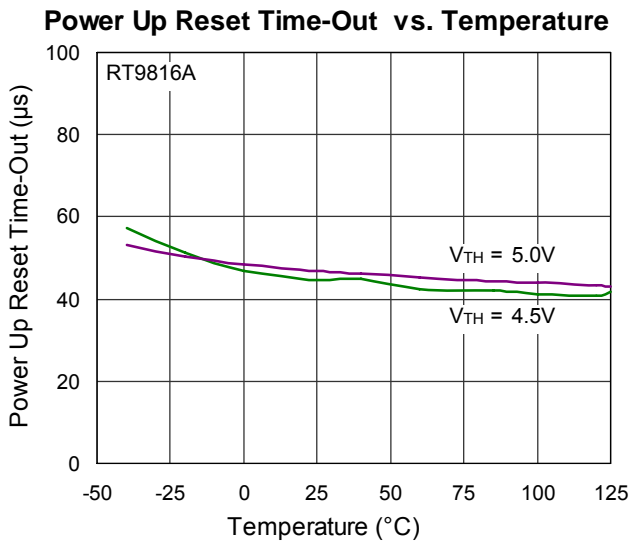
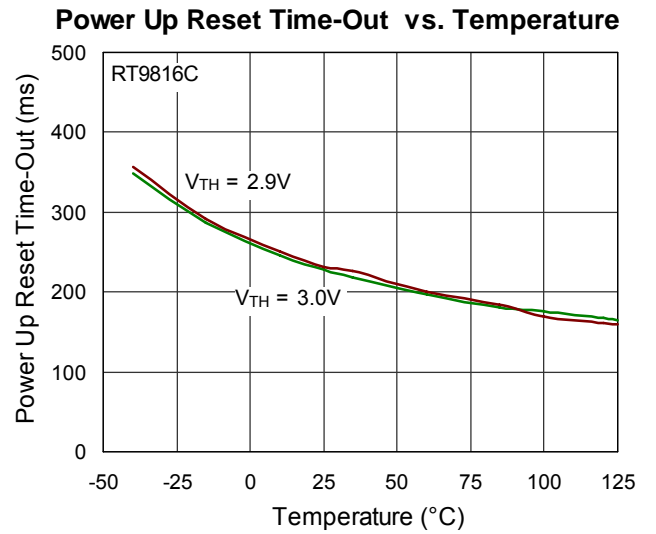
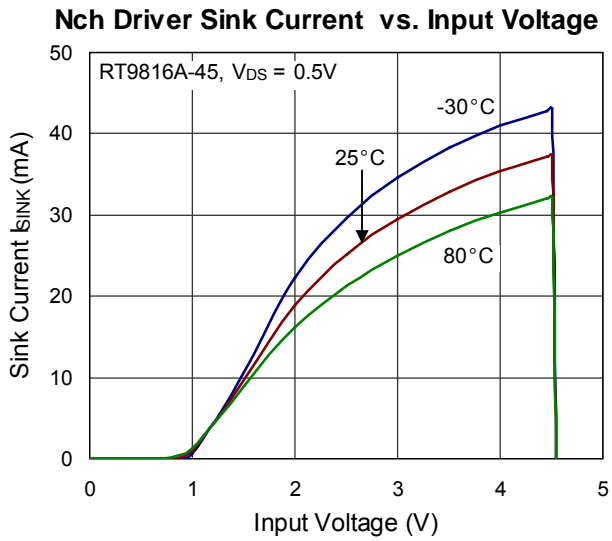

Power Down Reset Time-Out vs. Temperature

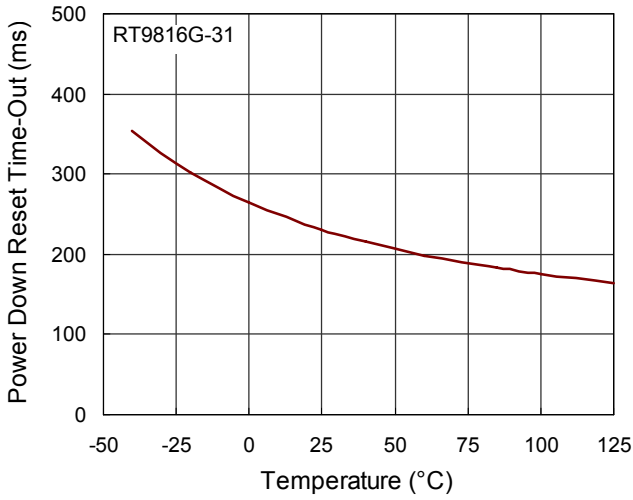

Output Voltage vs. Input Voltage

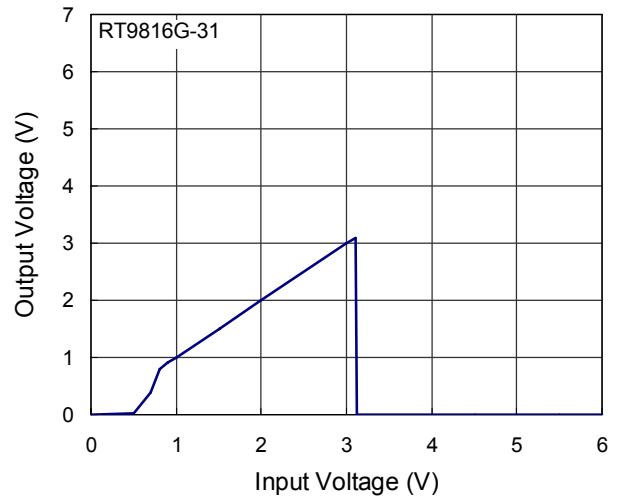

Power Down Reset Time-Out vs. Temperature

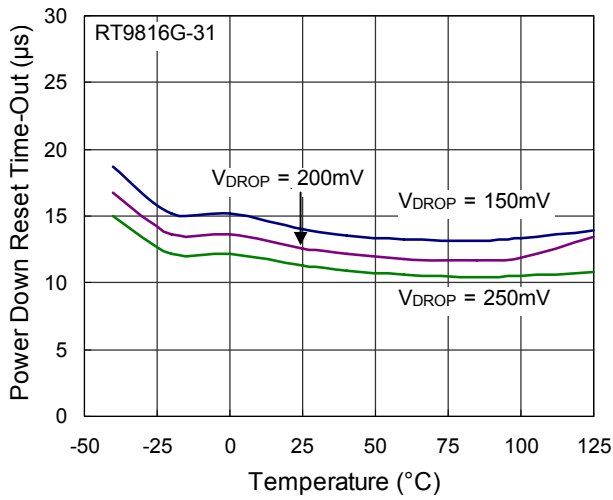

Application Information

Multiple Supplies

Mainly, the pull-up connected to the RT9816 will connect to the supply voltage that is being monitored at the IC's VCC pin. However, some systems may use the open-drain output to level-shift from the monitored supply to reset circuitry powered by some other supply.

Benefits of Highly Accurate Reset Threshold

Most μ P supervisor ICs have reset threshold voltages between 1% and 1.5% below the value of nominal supply voltages. This ensures a reset will not occur within 1% of the nominal supply, but will occur when the supply is 1.5% below nominal.

Outline Dimension

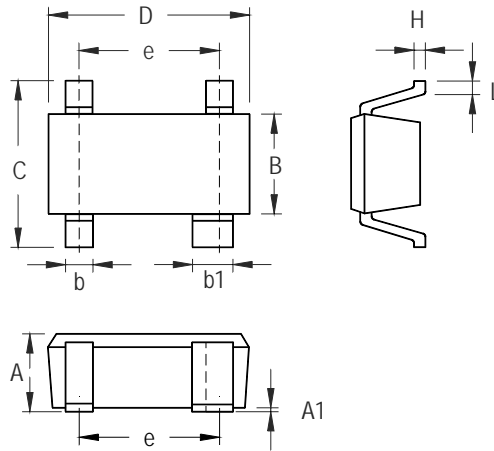

Symbol	Dimensions In Millimeters		Dimensions In Inches	
	Min	Max	Min	Max
A	0.800	1.100	0.031	0.043
A1	0.000	0.100	0.000	0.004
B	1.150	1.350	0.045	0.053
b	0.150	0.400	0.006	0.016
b1	0.350	0.500	0.014	0.020
C	1.800	2.450	0.071	0.096
D	1.800	2.200	0.071	0.087
e	1.300		0.051	
H	0.080	0.260	0.003	0.010
L	0.200	0.460	0.008	0.018

SC-82 Surface Mount Package

Richtek Technology Corporation

5F, No. 20, Taiyuen Street, Chupei City
 Hsinchu, Taiwan, R.O.C.
 Tel: (8863)5526789

Richtek products are sold by description only. Richtek reserves the right to change the circuitry and/or specifications without notice at any time. Customers should obtain the latest relevant information and data sheets before placing orders and should verify that such information is current and complete. Richtek cannot assume responsibility for use of any circuitry other than circuitry entirely embodied in a Richtek product. Information furnished by Richtek is believed to be accurate and reliable. However, no responsibility is assumed by Richtek or its subsidiaries for its use; nor for any infringements of patents or other rights of third parties which may result from its use. No license is granted by implication or otherwise under any patent or patent rights of Richtek or its subsidiaries.