

4 Channel DC/DC Converters IC with High-Efficiency Step-Up and Step-Down

General Description

The RT9902 is a complete power supply solution for digital still cameras and other hand-held devices. It integrates a high-efficiency main step-up DC-DC converter, two high-efficiency step-down converters, a charge pump, and a linear controller that drives an external P-MOSFET for linear regulator. The RT9902 is targeted for applications that use either two or three AA cells or a single lithiumion battery.

The main step-up DC-DC converter accepts inputs from 1.5V to 5.5V and build in 2.6A Internal switch. The two step-down DC-DC converters (CH2, CH3) accept inputs from 1.5V to 5.5V and regulate a resistor adjustable output from 0.8V to 5.5V. Each DC-DC converter has independent shutdown input.

The feature of the charge pump is to deliver few current to micro-controller when the system operates in the standby mode. RT9902 includes a linear controller with 0.8V reference voltage. An adjustable operating frequency (up to 1.4MHz) is utilized to get optimum size, cost, and efficiency.

RT9902 is available in VQFN-32L 5x5 package.

Ordering Information

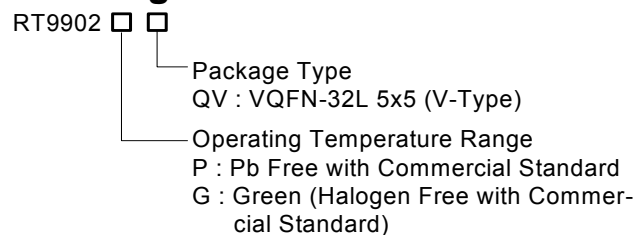

Note :

Richtek Pb-free and Green products are :

- ▶RoHS compliant and compatible with the current requirements of IPC/JEDEC J-STD-020.
- ▶Suitable for use in SnPb or Pb-free soldering processes.
- ▶100% matte tin (Sn) plating.

Features

- 1.5V to 5.5V Battery Input Voltage Range
- Main step-up DC-DC Converter
 - ▶1.5V to 5.5V Adjustable Output Voltage
 - ▶Up to 90% Efficiency
 - ▶2.6A, 0.3Ω Internal Power Switch
- Two Step-Down DC-DC Converters
 - ▶0.8V to 5.5V Adjustable Output Voltage
 - ▶94% Efficiency
 - ▶100% Duty Cycle
- Step-up Charge Pump for Micro-Controller
- Linear Controller for Linear Regulator
- Up to 1.4MHz Switching Frequency
- 1μA Supply Current in Shutdown Mode
- Programmable Soft Start Function
- Independent Enable Pin (CH1, CH2, CH3)
- External Compensation Network (CH1, CH2, CH3)
- Short Circuit Protection (CH1, CH2, CH3)
- Over Voltage Protection (CH2)
- 32-Lead VQFN Package
- RoHS Compliant and 100% Lead (Pb)-Free

Applications

- Digital Still Cameras
- PDAs
- Portable Devices

Pin Configurations

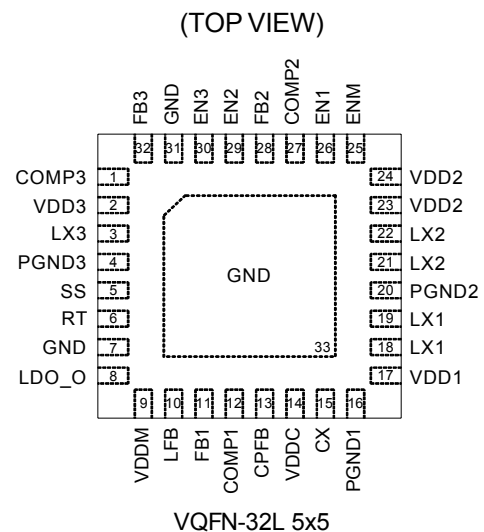

Typical Application Circuit

1-cell Li+ Battery 3V to 4.2V

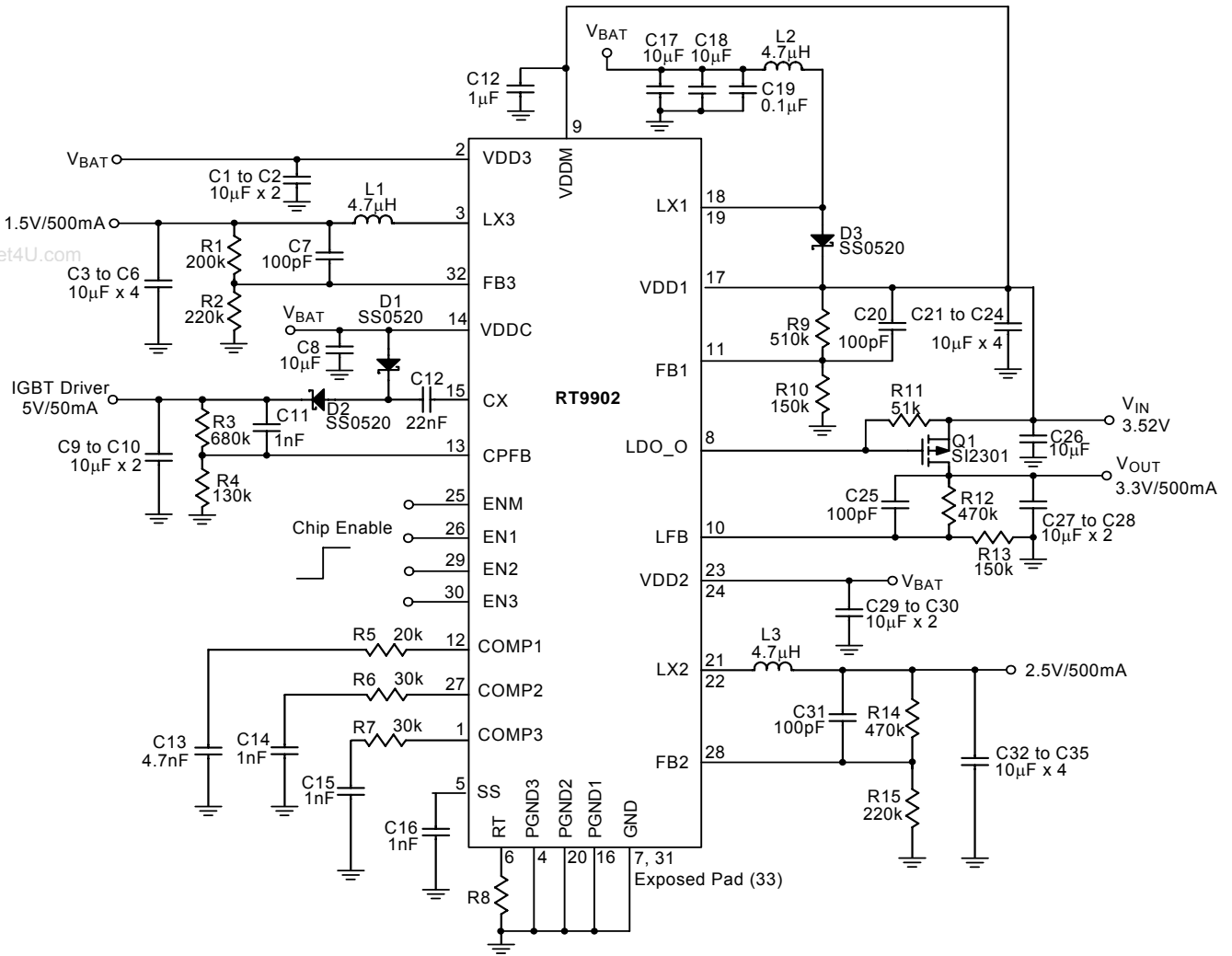

Figure 1. Typical Application Circuit from 1-cell Li+ Battery

1-cell Li+ Battery 3.4V to 4.2V

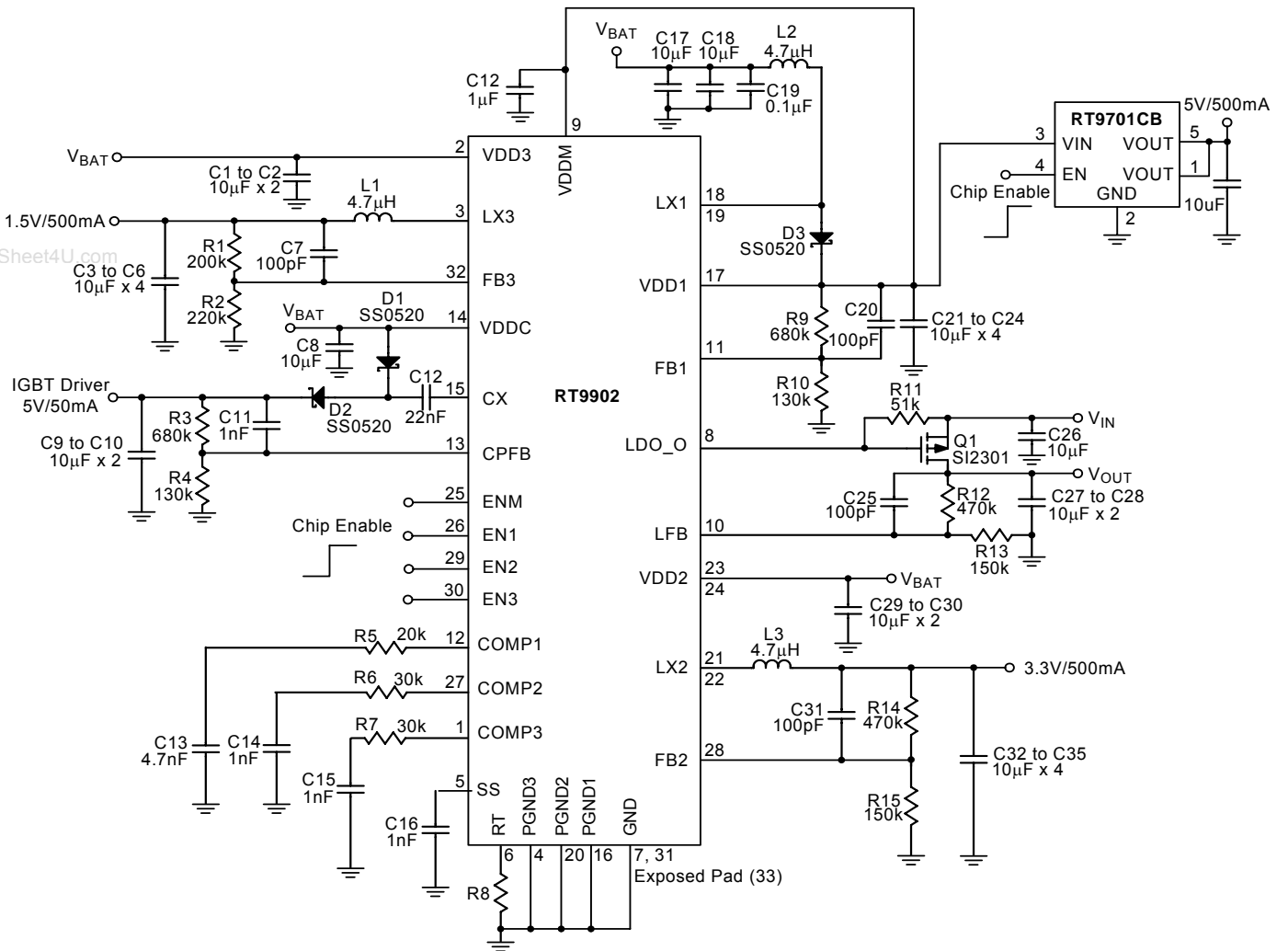

Figure 2. Typical Application Circuit from 1-cell Li+ Battery

2-AA Battery 2.0V to 3.4V

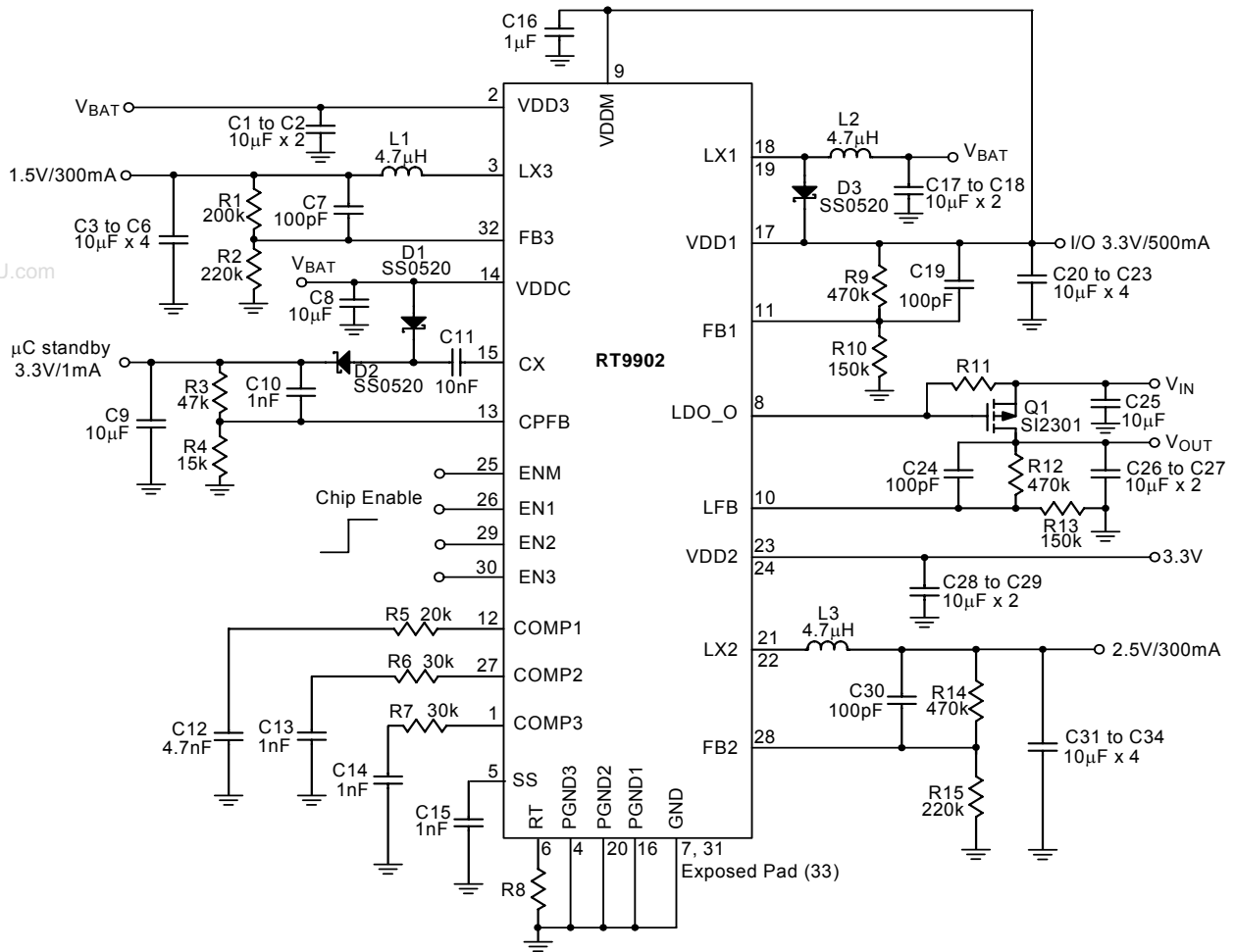
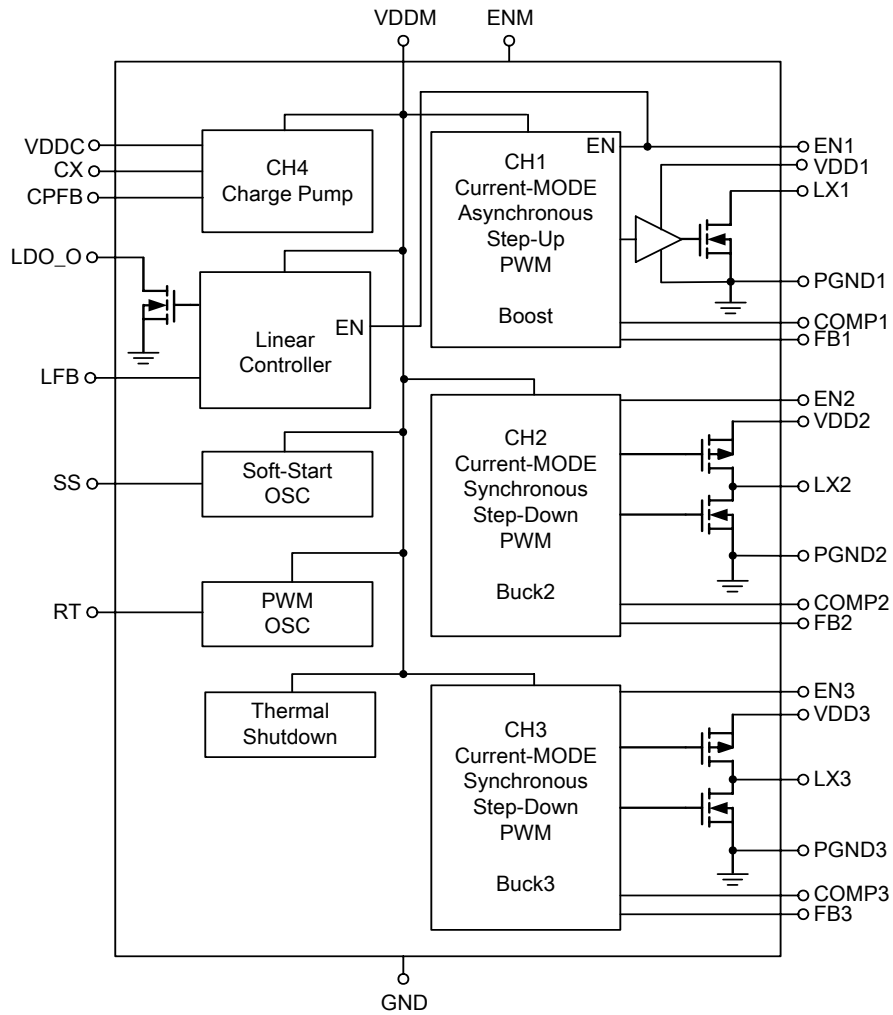

Figure 3. Typical Application Circuit from 2-AA Battery Supply

Function Block Diagram



ENM	EN1	EN2	EN3	Charge Pump	CH1 + Linear Controller	CH2	CH3
0	X	X	X	Off	Off	Off	Off
1	0	0	0	On	Off	Off	Off
1	1	0	0	On	On	Off	Off
1	1	1	0	On	On	On	Off
1	1	1	1	On	On	On	On

Functional Pin Description

Pin No.	Pin Name	Pin Function
1	COMP3	CH3 Feedback Compensation Pin.
2	VDD3	CH3 Power Input Pin.
3	LX3	CH3 Switch Node. Drains of the internal P-Channel and N-MOSFET switches. Connect an inductor to LX3 pins together as close as possible.
4	PGND3	Power Ground for CH3.
5	SS	Sets the soft start interval of the converter. Connect a capacitor from this pin to ground.
6	RT	Frequency Setting Resistor Connection Pin. Frequency is 500kHz if RT pin not connected.
7	GND	Analog Ground.
8	LDO_O	Linear Controller Driver Output.
9	VDDM	Device Input Power Pin.
10	LFB	Linear Controller Feedback Input.
11	FB1	CH1 Feedback Input Pin.
12	COMP1	CH1 Feedback Compensation Pin.
13	CPFB	Charge Pump Feedback Pin.
14	VDDC	Charge Pump Power Input Pin.
15	CX	Charge Pump External Driver Pin.
16	PGND1	Power Ground for CH1.
17	VDD1	CH1 Power Input Pin. Connect output of Boost to this pin.
18, 19	LX1	CH1 Switch Node. Connect an inductor to LX1 pins together as close as possible.
20	PGND2	Power Ground for CH2.
21, 22	LX2	CH2 Switch Node. Drains of the internal P-MOSFET and N-MOSFET switches. Connect an inductor to LX2 pins together as close as possible.
23, 24	VDD2	CH2 Power Input Pin.
25	ENM	Whole Device Control Pin. Tie this pin higher than 1.3V to enable the device. Tie below 0.4V to turn off the device.
26	EN1	CH1 Enable Input. Tie this pin higher than 1.3V to enable CH1. Tie below 0.4V to turn off the CH1.
27	COMP2	CH2 Feedback Compensation Pin.
28	FB2	CH2 Feedback Input.
29	EN2	CH2 Enable Input. Tie this pin higher than 1.3V to enable CH2. Tie below 0.4V to turn off the CH2.
30	EN3	CH3 Enable Input. Tie this pin higher than 1.3V to enable CH3. Tie below 0.4V to turn off the CH3.
31	GND	Analog Ground.
32	FB3	CH3 Feedback Input.
Exposed Pad (33)	GND	The exposed pad must be soldered to a large PCB and connected to GND for maximum power dissipation.

Absolute Maximum Ratings

- Supply Input Voltage ($V_{DDM}, V_{DD1}, V_{DD2}, V_{DD3}, V_{DDC}$) ----- -0.3 to 7V
- LX1 Pin Switch Voltage ----- -0.3V to 7V
- LX2 Pin Switch Voltage ----- -0.3V to ($V_{DD2} + 0.3V$)
- LX3 Pin Switch Voltage ----- -0.3V to ($V_{DD3} + 0.3V$)
- CX Pin Switch Voltage ----- -0.3V to ($V_{DDC} + 0.3V$)
- Other I/O Pin Voltage ----- -0.3V to ($V_{DDM} + 0.3V$)
- Package Thermal Resistance
 VQFN-32L 5x5, θ_{JA} ----- 34°C/W
- Lead Temperature (Soldering, 10 sec.) ----- 260°C
- Operation Temperature Range ----- -40°C to 85°C
- Junction Temperature Range ----- 0°C to 125°C
- Storage Temperature Range ----- -65°C to 150°C
- ESD Susceptibility
 HBM (Human Body Mode) ----- 2kV
 MM (Machine Mode) ----- 200V

Electrical Characteristics

($V_{DDM} = 3.3V, T_A = 25^\circ C$, Unless Otherwise specification)

Parameter	Symbol	Test Condition	Min	Typ	Max	Units
Supply Voltage						
Minimum Startup Voltage (Boost)	V_{ST}	Boost loading < 1mA	--	1.5	--	V
VDDM Operating Voltage	V_{VDDM}	VDDM Pin Voltage	2.4	--	5.5	V
VDD1, VDD2, VDD3 Operating Voltage	V_{VDD1} V_{VDD2} , V_{VDD3}	VDD1, VDD2, VDD3 Pin Voltage	1.5		5.5	V
VDDM Over Voltage Protection			--	6.5	--	V
Supply Current						
Shutdown Supply Current	I_{OFF}	V_{ENM} pin=0V	--	0.01	1	μA
Charge Pump Current	I_{VDDM}	$V_{VDDM} = 3.3V, V_{ENM} = 3.3V,$ $V_{EN1} = 0V, V_{EN2} = 0V,$ $V_{EN3} = 0V$	--	30	42	μA
CH1 DC/DC Converter + Linear Controller Supply Current	I_{VDDM}	$V_{VDDM} = 3.3V,$ $V_{FB1} = 0.9V$ $V_{ENM} = 3.3V, V_{EN1} = 3.3V,$ $V_{EN2} = 0V, V_{EN3} = 0V$	--	250	350	μA
CH2 DC/DC Converter Supply Current	I_{VDDM}	$V_{VDDM} = 3.3V,$ $V_{FB2} = 0.9V$ $V_{ENM} = 3.3V, V_{EN1} = 0V,$ $V_{EN2} = 3.3V, V_{EN3} = 0V$	--	250	350	μA
CH3 DC/DC Converter Supply Current	I_{VDDM}	$V_{VDDM} = 3.3V,$ $V_{FB3} = 0.9V$ $V_{ENM} = 3.3V, V_{EN1} = 0V,$ $V_{EN2} = 0V, V_{EN3} = 3.3V$	--	250	350	μA

To be continued

Parameter	Symbol	Test Condition	Min	Typ	Max	Units
Oscillator						
Operation Frequency Range	F _{OSC}	RT Open	475	550	625	kHz
CH1 Maximum Duty Cycle	D _{MAX1}		--	85	90	%
CH2 Maximum Duty Cycle	D _{MAX2}		--	--	100	%
CH3 Maximum Duty Cycle	D _{MAX3}		--	--	100	%
Feedback Voltage (CH1, CH2, CH3, CH4)						
Feedback Voltage	V _{FB}	CH1, CH2, CH3	0.788	0.8	0.812	V
Feedback Voltage (Charge Pump)	V _{CPFB}	CH4	0.78	0.8	0.82	V
Feedback Voltage	ΔV _{FB}	CH1, CH2, CH3, CH4 3.0V < V _{DDM} < 5.5V	--	--	12	mV
Error Amplifier						
GM			--	0.2	--	ms
Compensation Source Current			--	22	--	μA
Compensation Sink Current			--	22	--	μA
Power Switch						
CH1 On Resistance of MOSFET	R _{DS(ON)}	N-MOSFET	--	300	400	mΩ
CH1 Current Limitation		V _{VDD1} = 3.3V	2	2.6	3	A
CH2 On Resistance of MOSFET	R _{DS(ON)}	N-MOSFET, V _{VDD2} = 3.3V	--	350	450	mΩ
		P-MOSFET, V _{VDD2} = 3.3V	--	350	450	mΩ
CH2 Current Limitation		V _{VDD2} = 3.3V	1.3	1.5	1.9	A
CH3 On Resistance of MOSFET	R _{DS(ON)}	N-MOSFET, V _{VDD3} = 3.3V	--	350	450	mΩ
		P-MOSFET, V _{VDD3} = 3.3V	--	350	450	mΩ
CH3 Current Limitation		V _{VDD3} = 3.3V	1.3	1.5	1.9	A
Linear Controller						
Feedback Voltage for Linear Controller	V _{LFB}		0.774	0.79	0.806	V
LDO_O pin Sink Current		V _{LDO_O} = 1V	110	150	--	μA
UVP (CH2, CH3) & Over Voltage Protection (CH2)						
UVP Threshold Voltage @FB2, FB3			0.3	0.4	0.5	V
Over Voltage Protection @FB2			0.95	1	--	V
Control						
ENM, EN1, EN2, EN3 Input High Level Threshold		V _{VDDM} = 3.3V	--	0.8	1.3	V
ENM, EN1, EN2, EN3 Input Low Level Threshold		V _{VDDM} = 3.3V	0.4	0.8	--	V
Thermal Protection						
Thermal Shutdown	T _{SD}		140	180	--	°C
Thermal Shutdown Hysteresis	ΔT _{SD}		--	10	--	°C

Typical Operating Characteristics

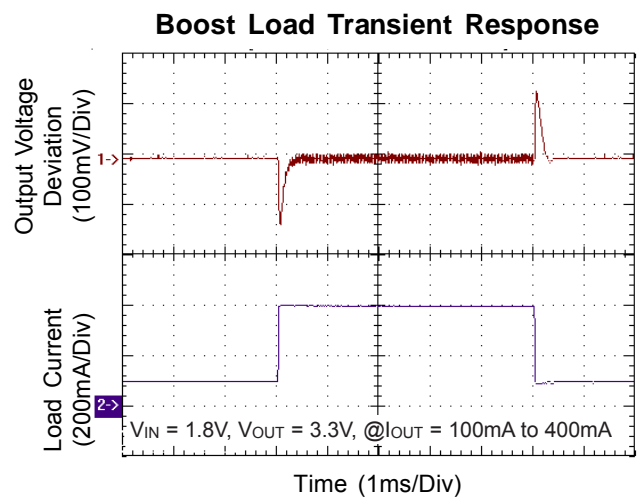
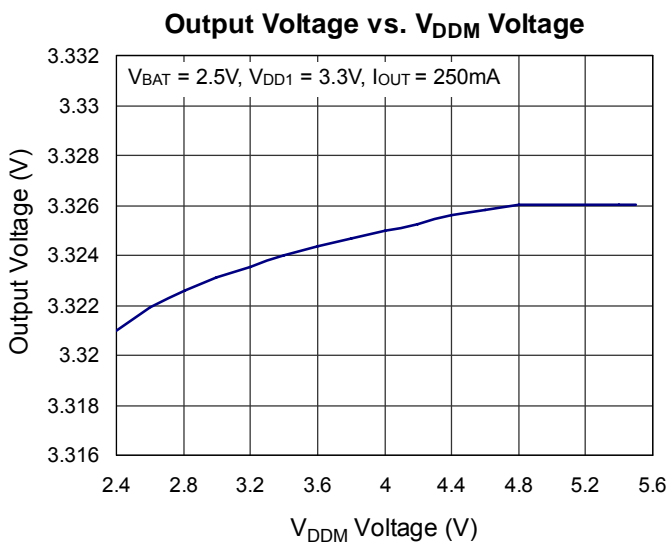
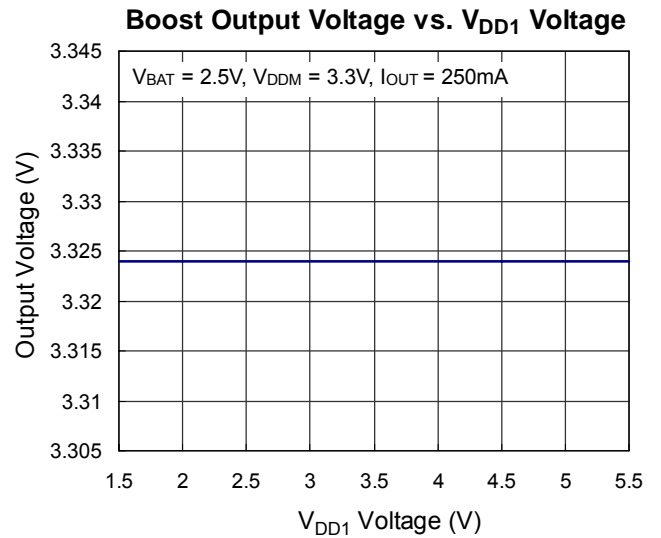
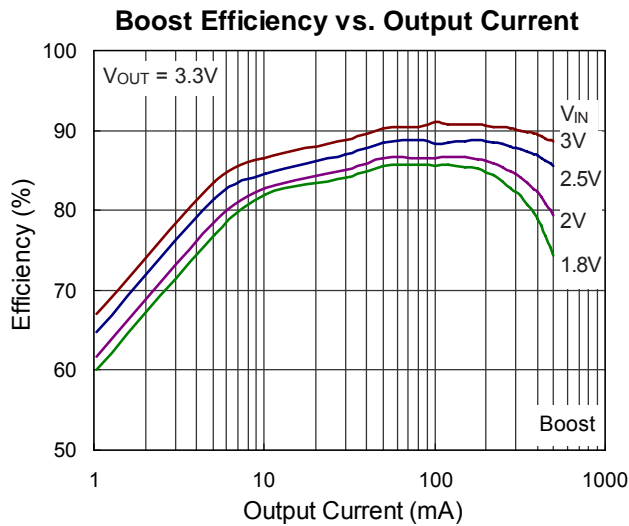
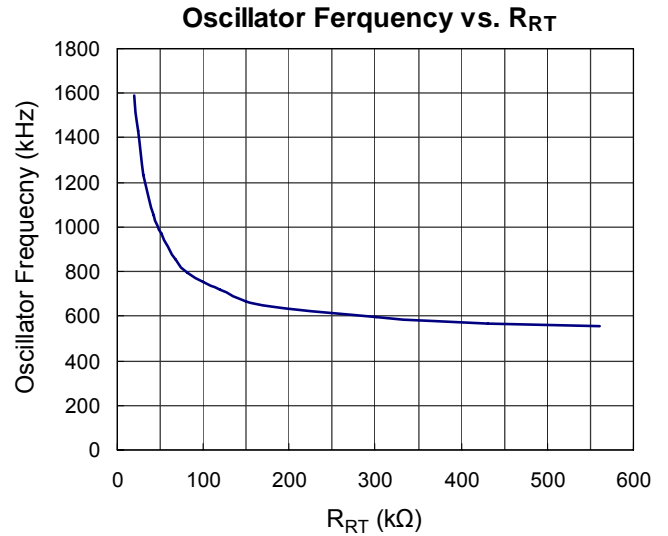
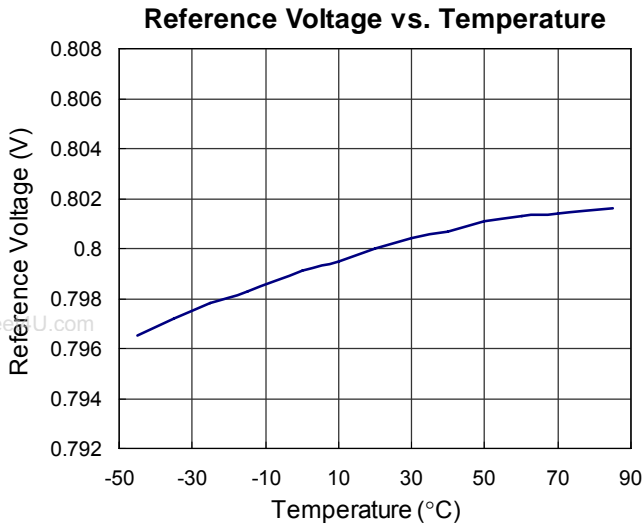

Boost Load Transient Response

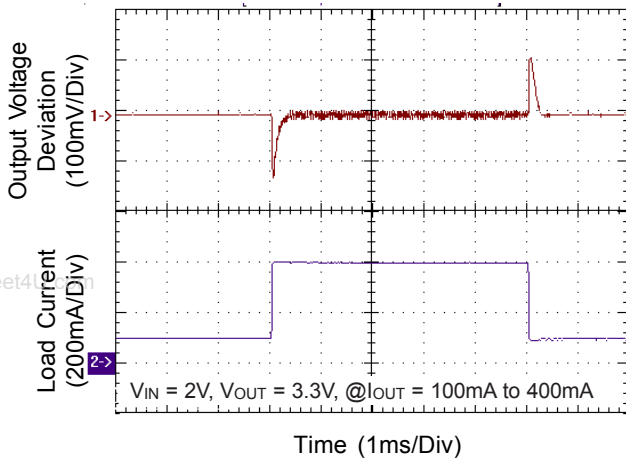

Boost Load Transient Response

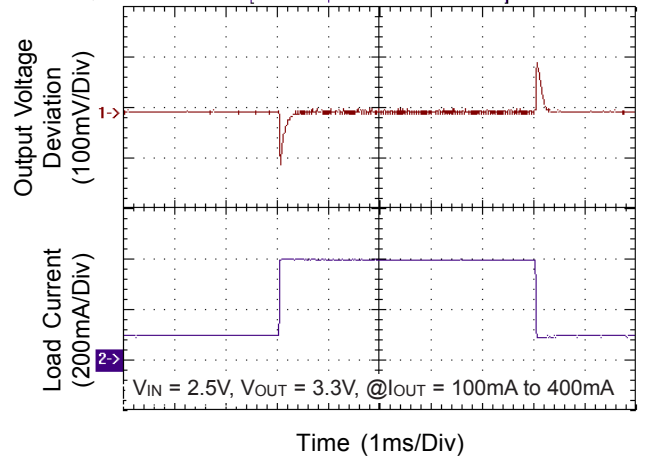

Boost Load Transient Response

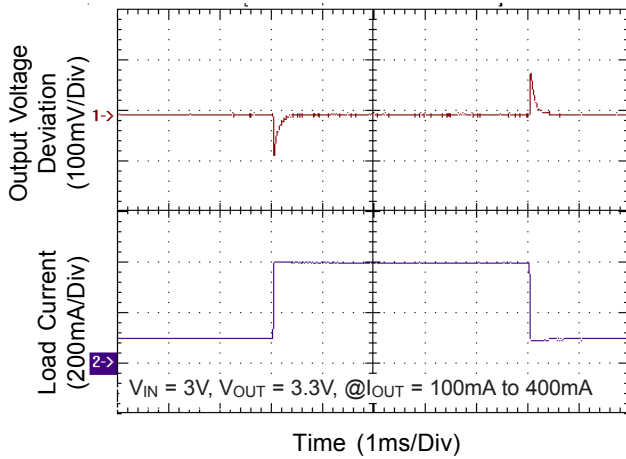

Boost LX & Output Ripple

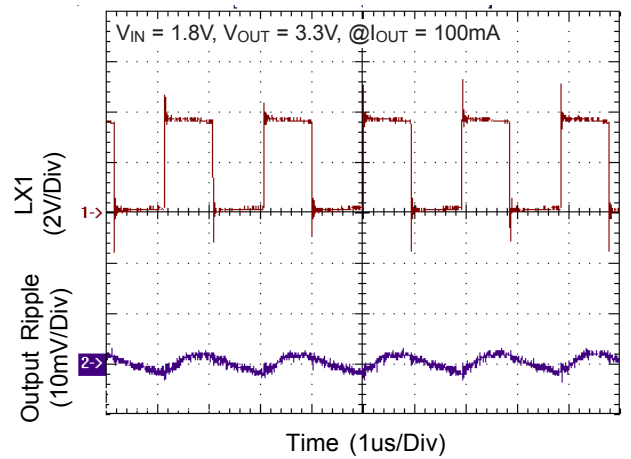

Boost LX & Output Ripple

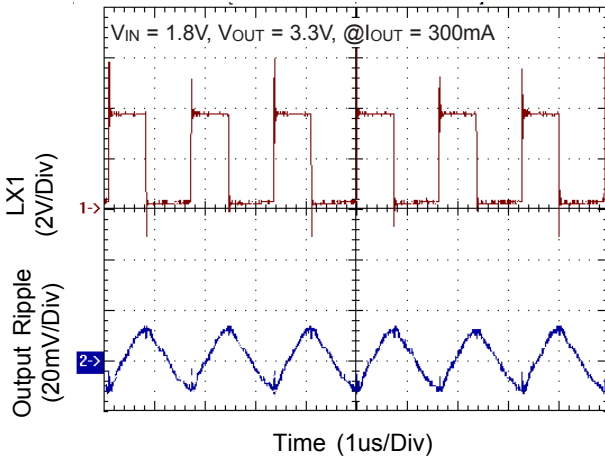

Boost LX & Output Ripple

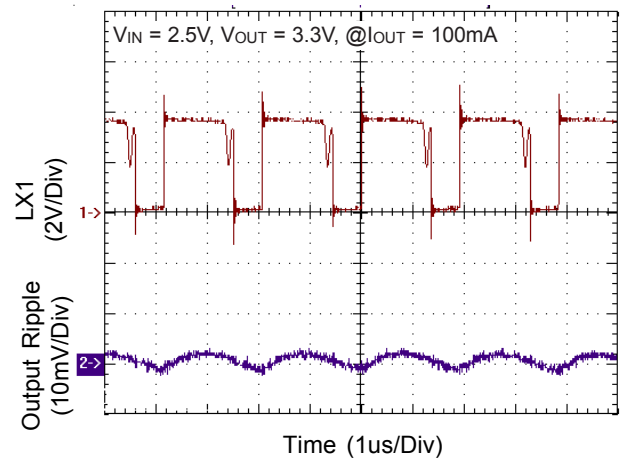

Boost LX & Output Ripple

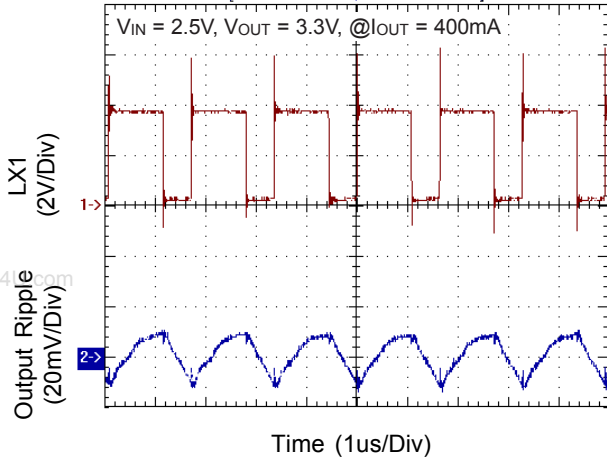

Boost LX & Output Ripple

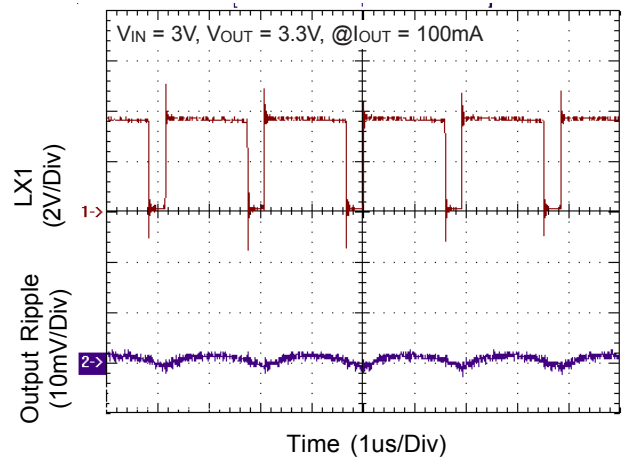

Boost LX & Output Ripple

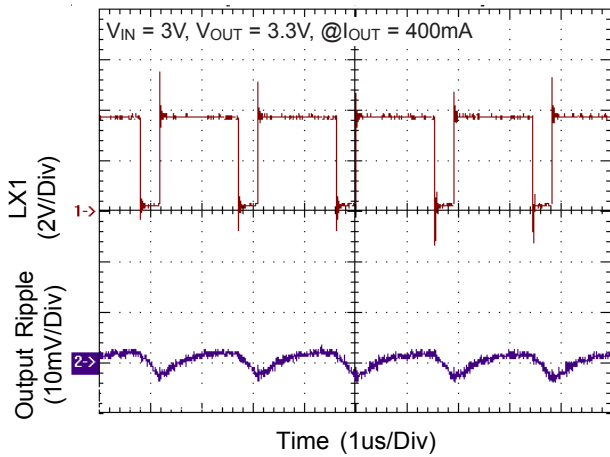

Buck2 Efficiency vs. Output Current

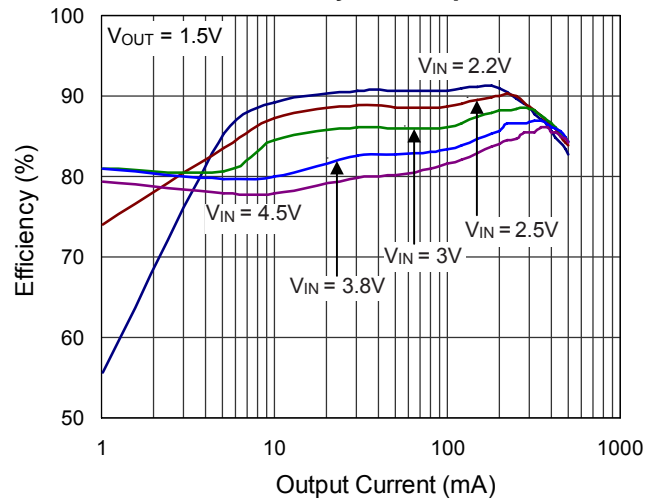

Buck2 Efficiency vs. Output Current

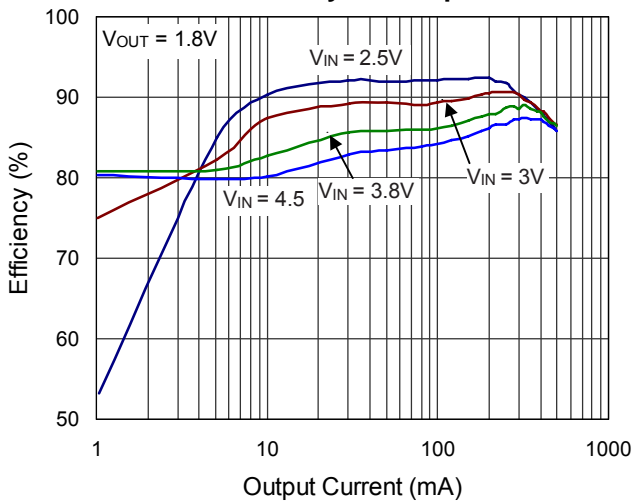

Buck2 Efficiency vs. Output Current

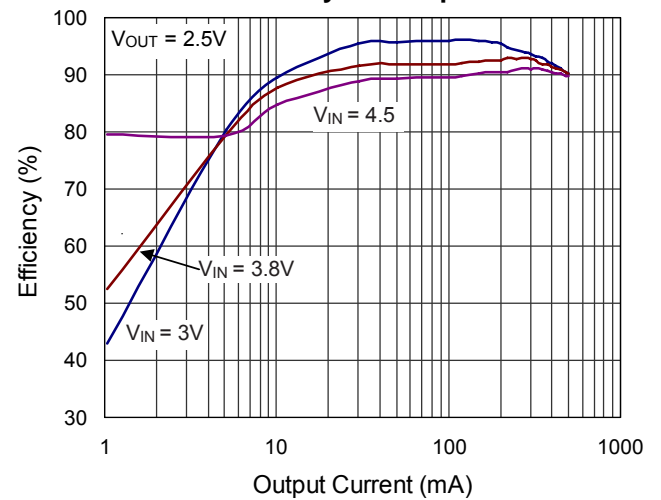

Buck2 Output Voltage vs. V_{DD2} Voltage

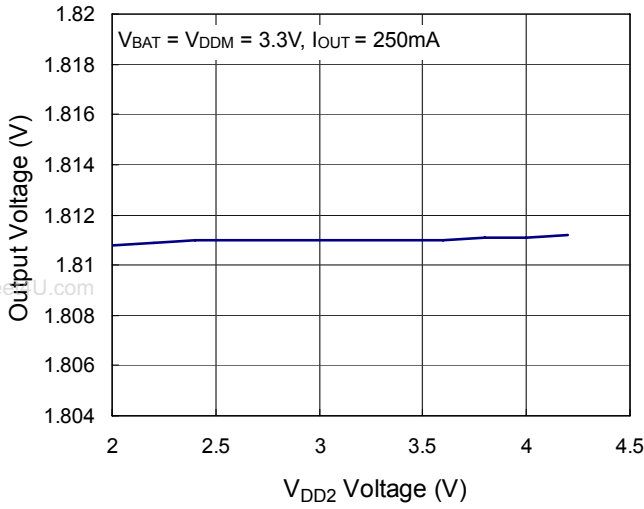

Buck2 Output Voltage vs. V_{DDM} Voltage

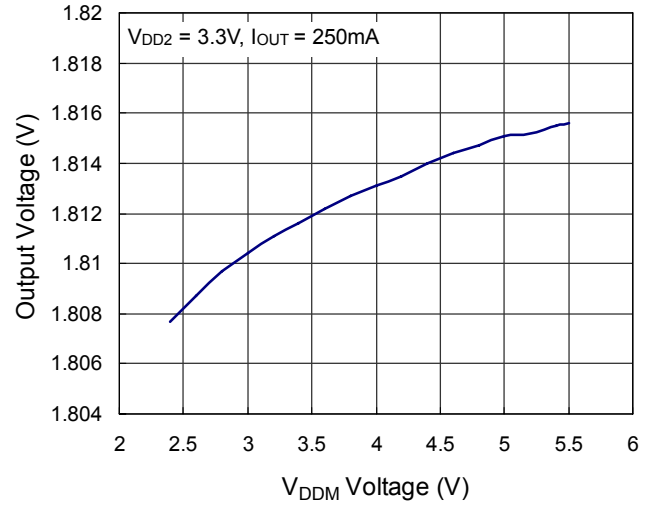

Buck2 Load Transient Response

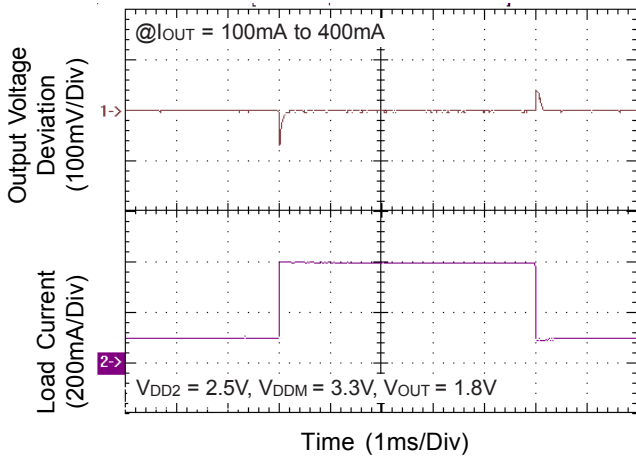

Buck2 Load Transient Response

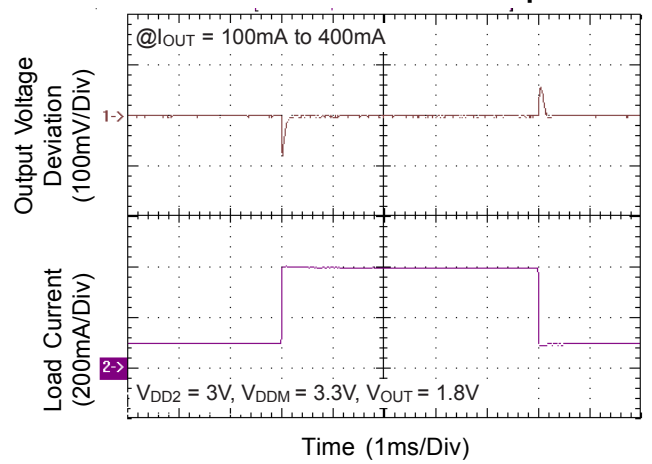

Buck2 Load Transient Response

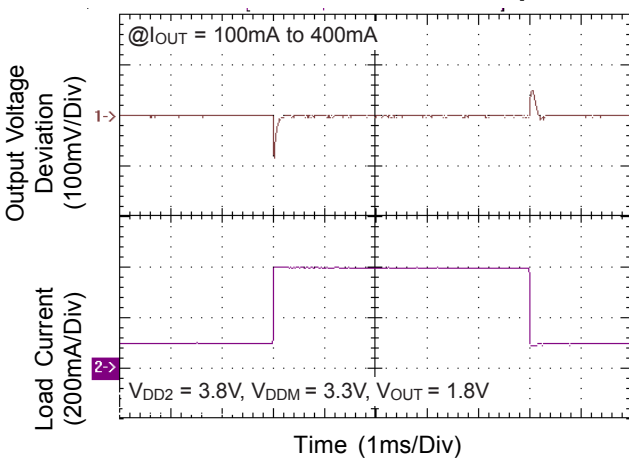

Buck2 Load Transient Response

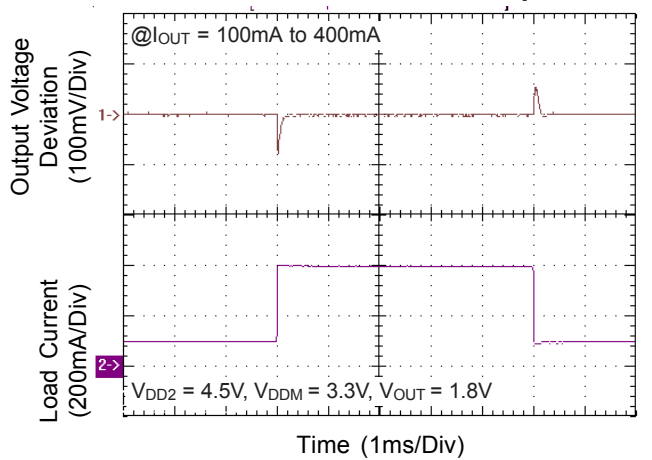

Buck2 LX & Output Ripple

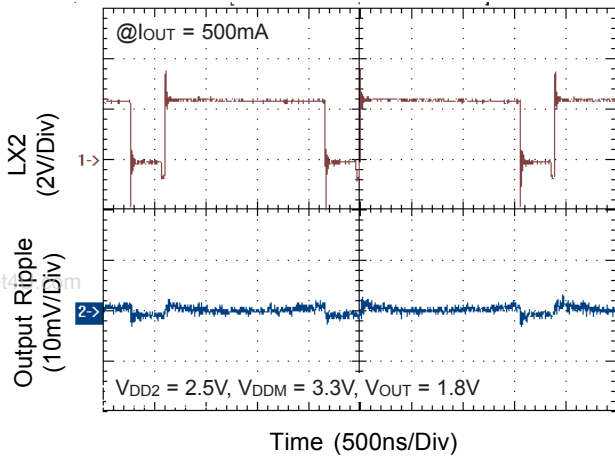

Buck2 LX & Output Ripple

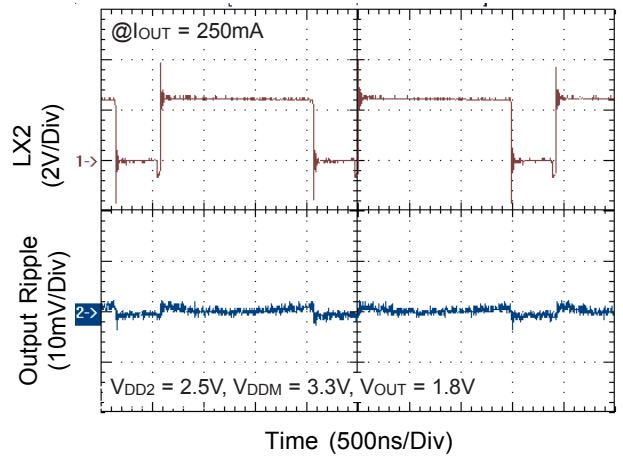

Buck2 LX & Output Ripple

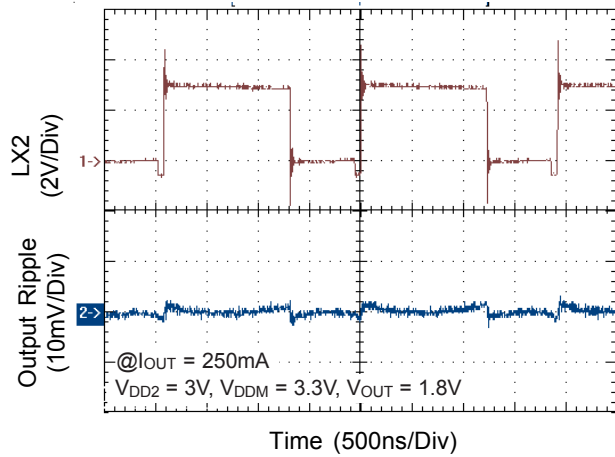

Buck2 LX & Output Ripple

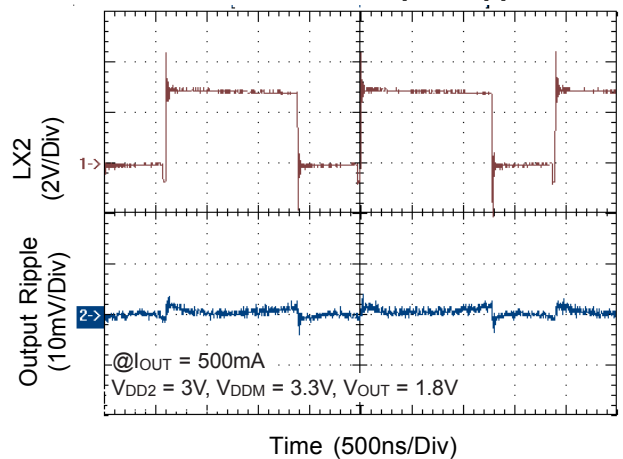

Buck2 LX & Output Ripple

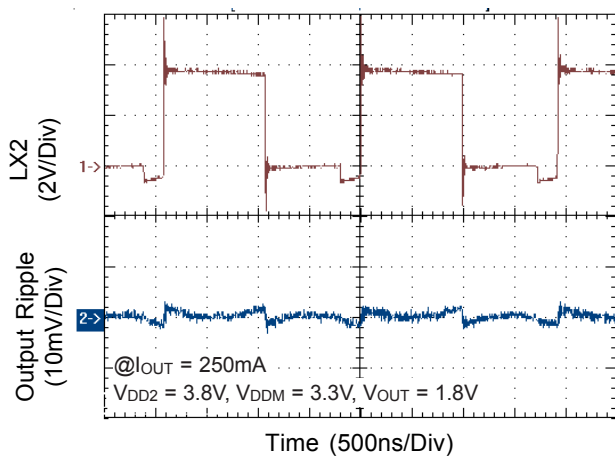

Buck2 LX & Output Ripple

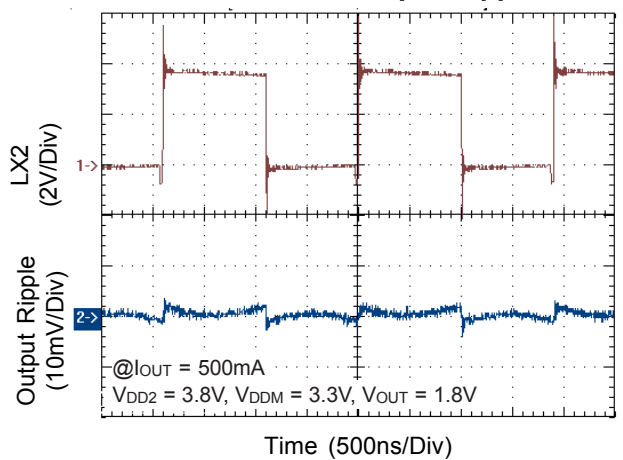

Buck2 LX & Output Ripple

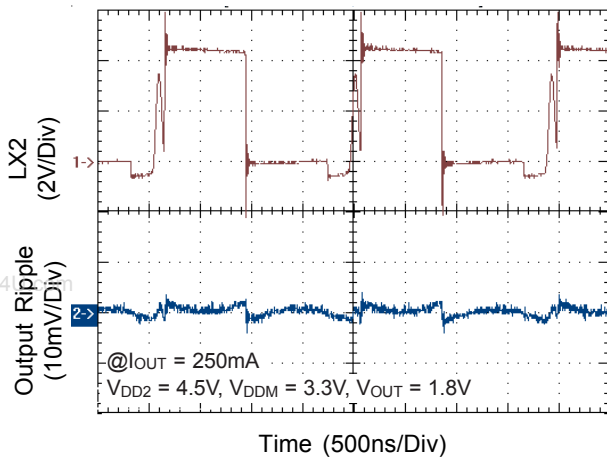

Buck2 LX & Output Ripple

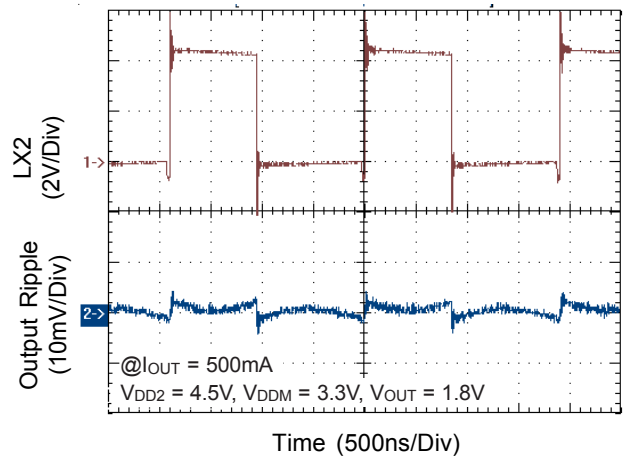

Buck3 Efficiency vs. Output Current

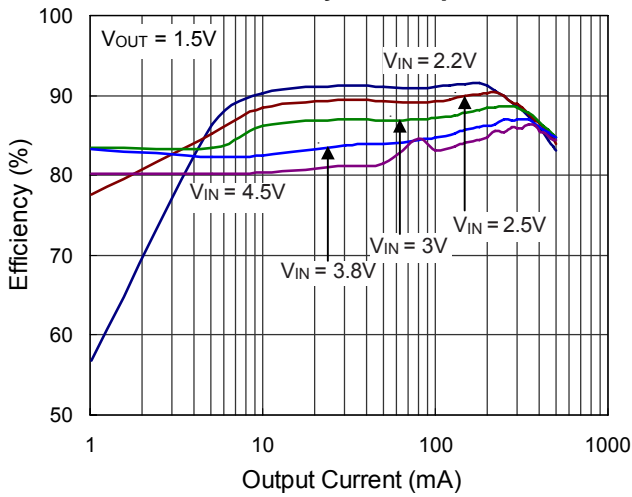

Buck3 Efficiency vs. Output Current

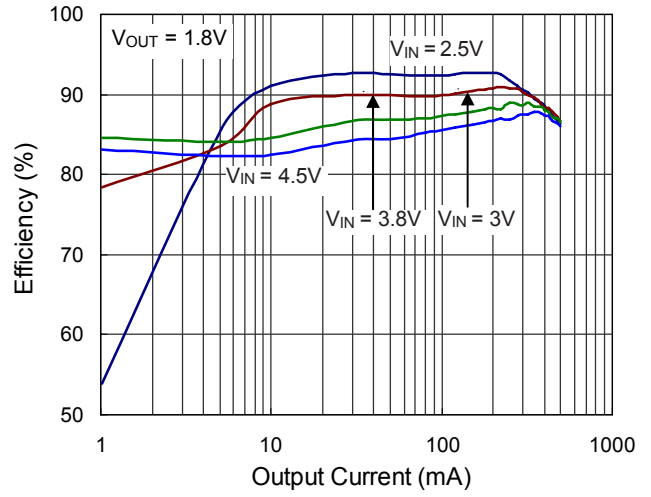

Buck3 Efficiency vs. Output Current

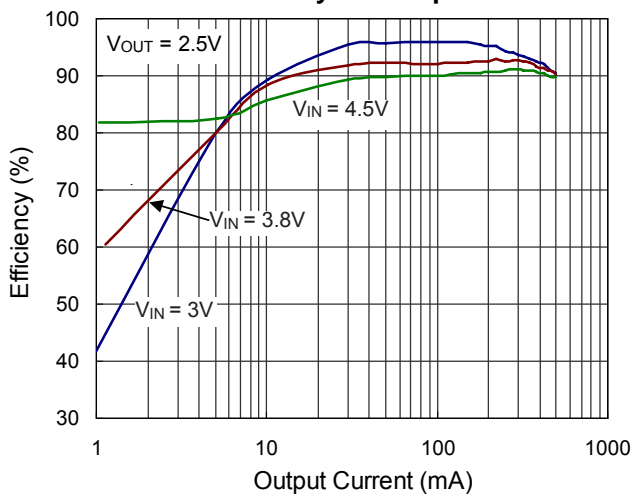

Buck3 Output Voltage vs. VDD3 Voltage

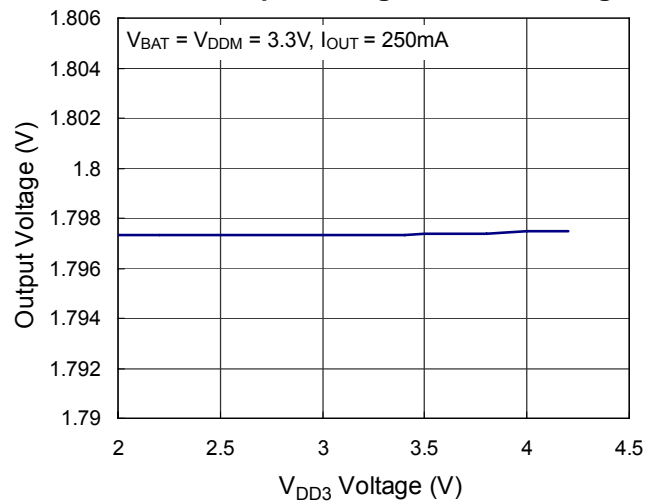

Buck3 Output Voltage vs. V_{DDM} Voltage

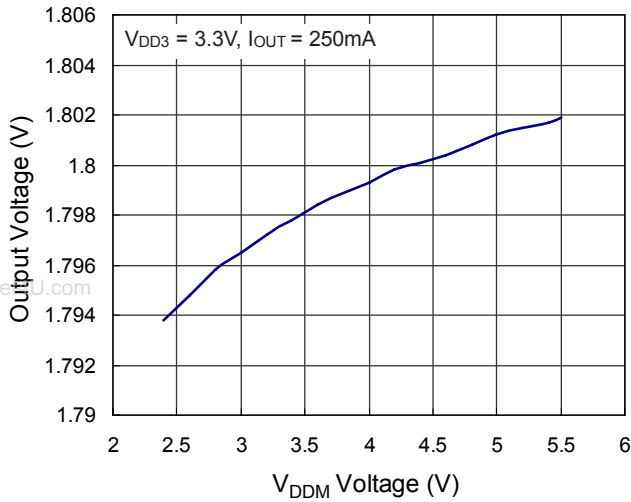

Buck3 Load Transient Response

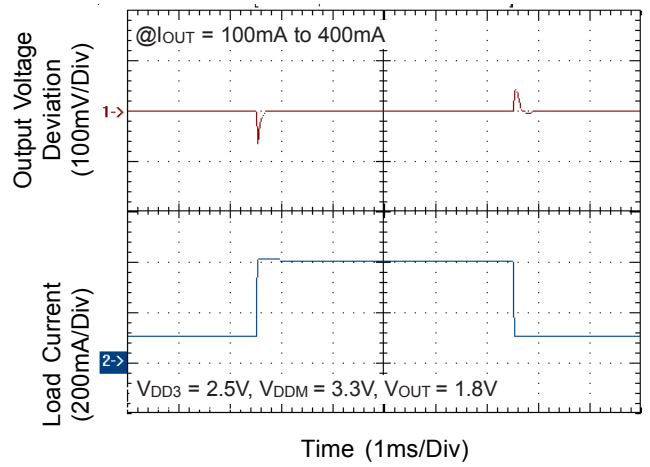

Buck3 Load Transient Response

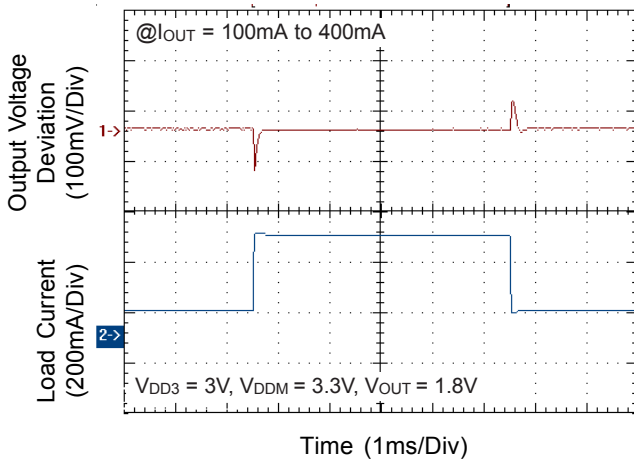

Buck3 Load Transient Response

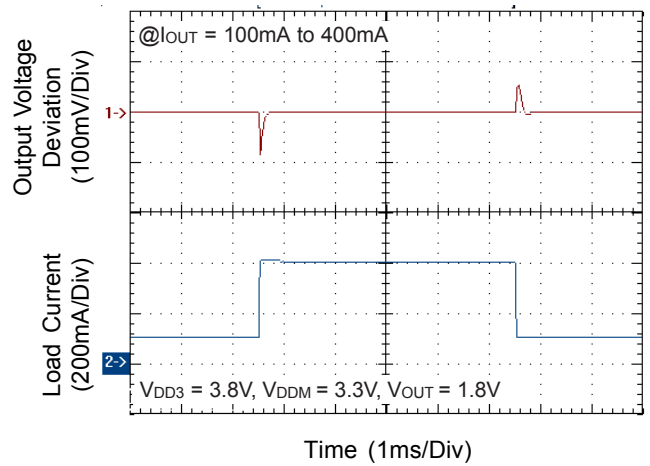

Buck3 Load Transient Response

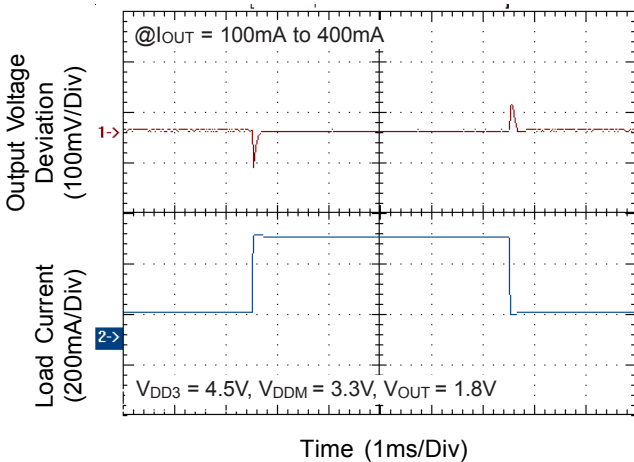

Buck3 LX & Output Ripple

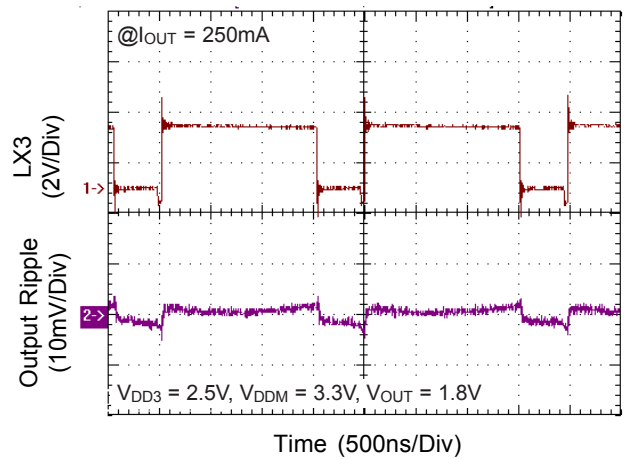

Buck3 LX & Output Ripple

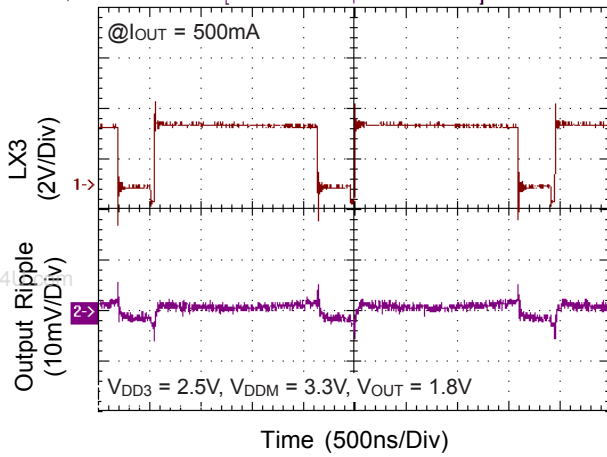

Buck3 LX & Output Ripple

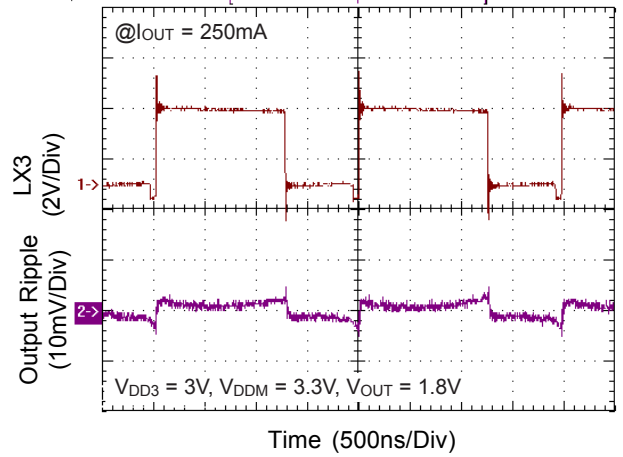

Buck3 LX & Output Ripple

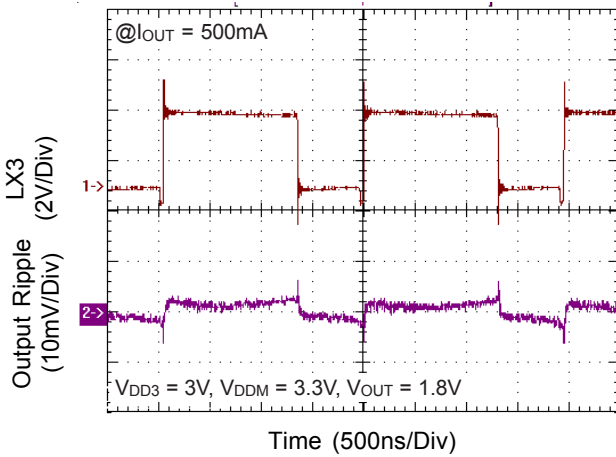

Buck3 LX & Output Ripple

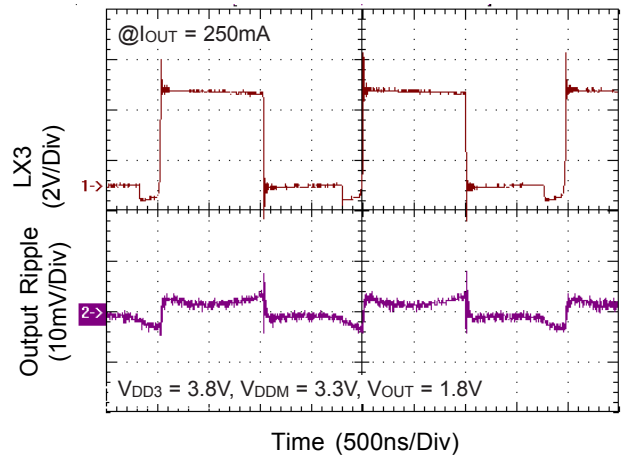

Buck3 LX & Output Ripple

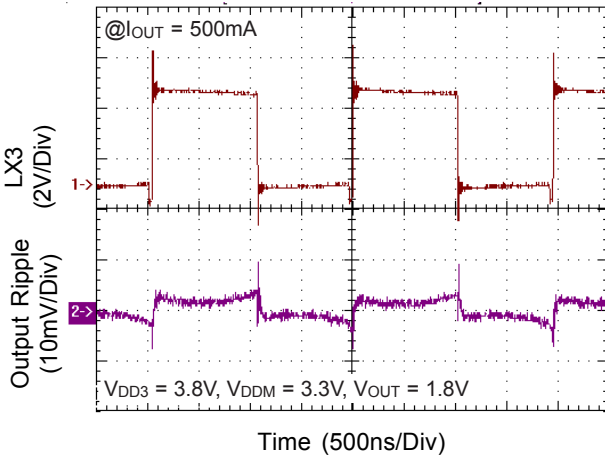

Buck3 LX & Output Ripple

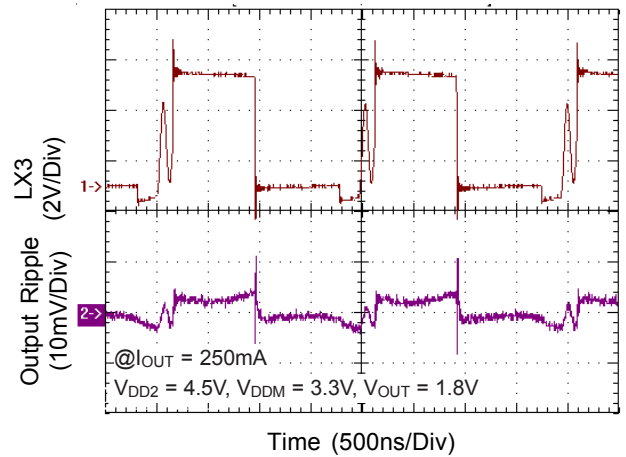

Buck3 LX & Output Ripple

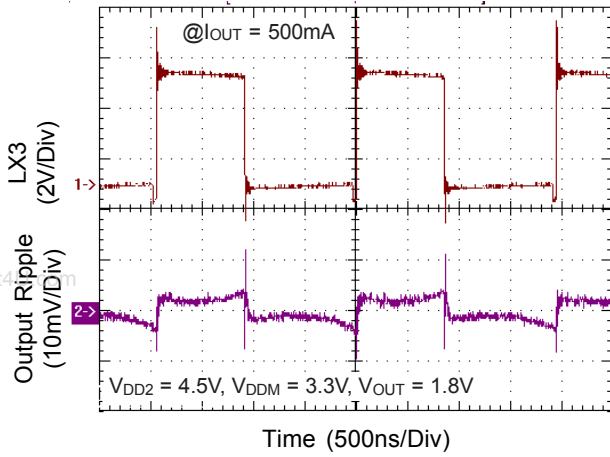

Charge Pump CX & Output Ripple

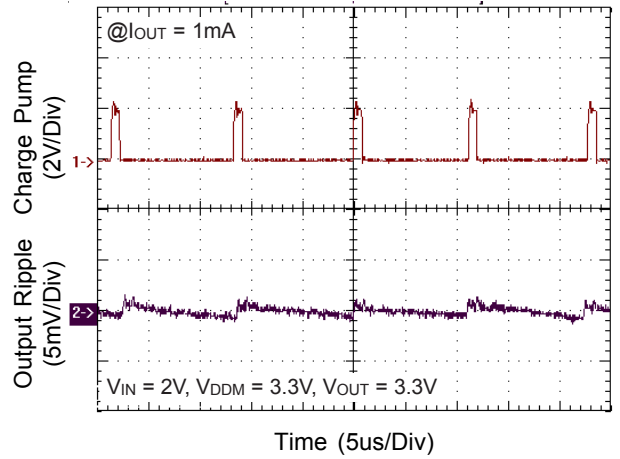

Charge Pump CX & Output Ripple

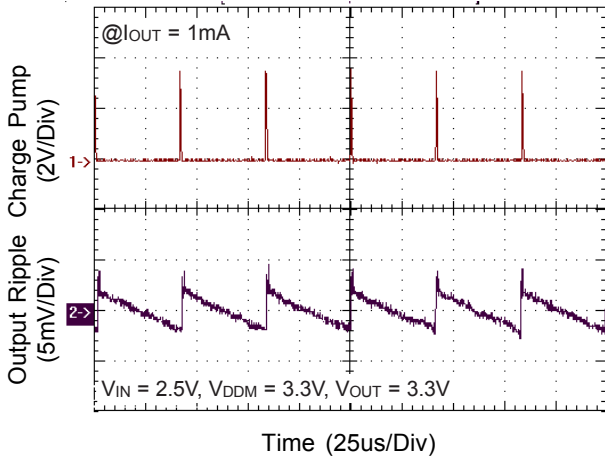

Linear Controller Load Transient Response

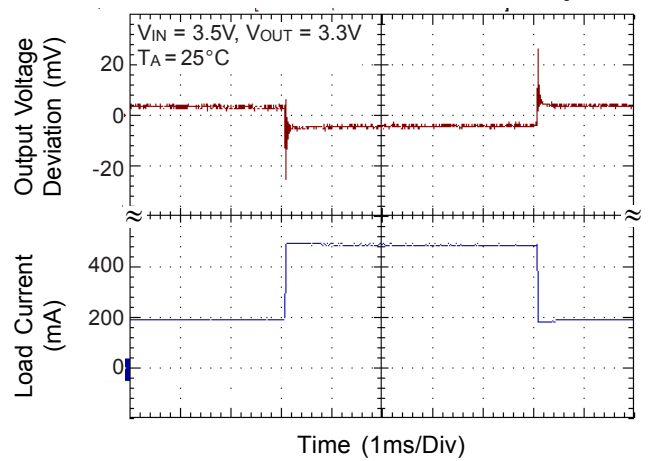

Linear Controller Load Transient Response

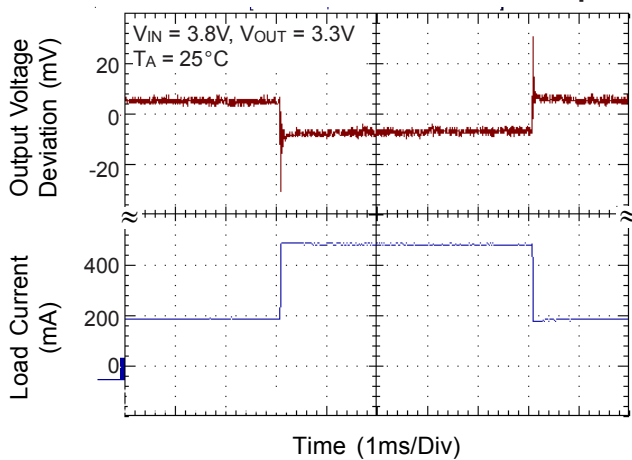

Linear Controller Load Transient Response

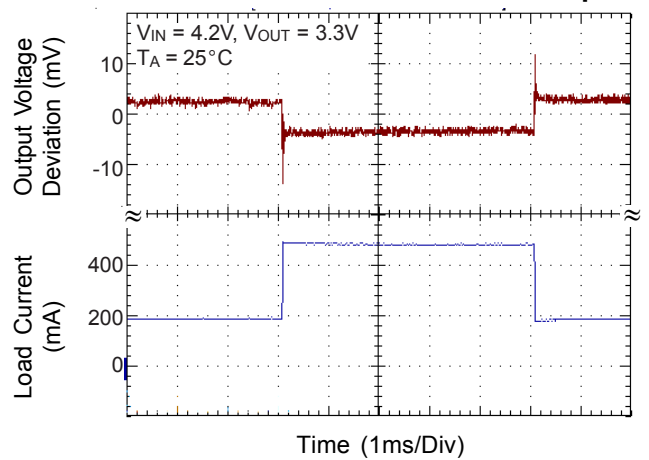

Boost Series Linear Controller Load Transient Response

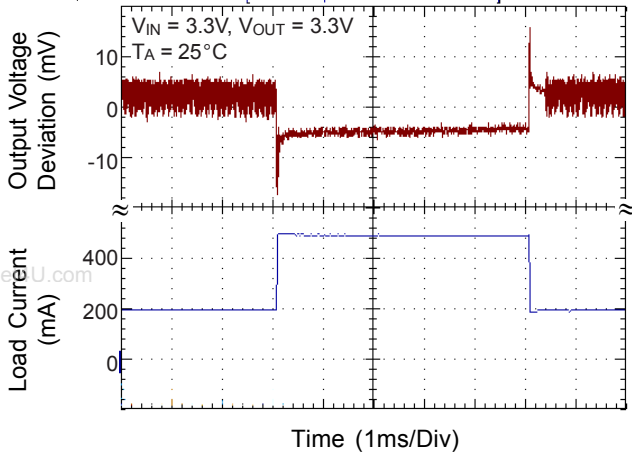

Boost Series Linear Controller Load Transient Response

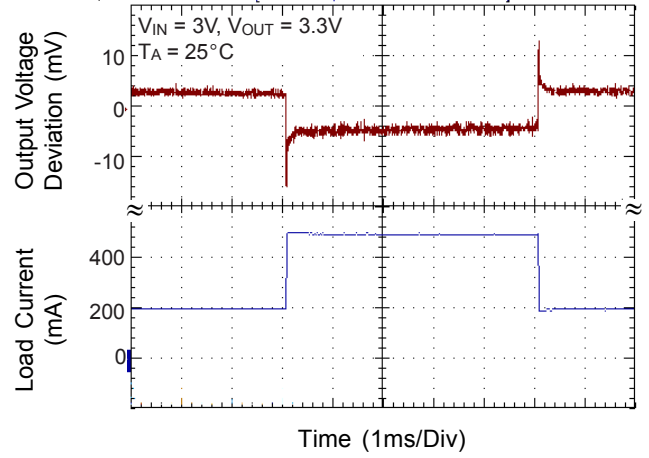

Boost Series Linear Controller Load Transient Response

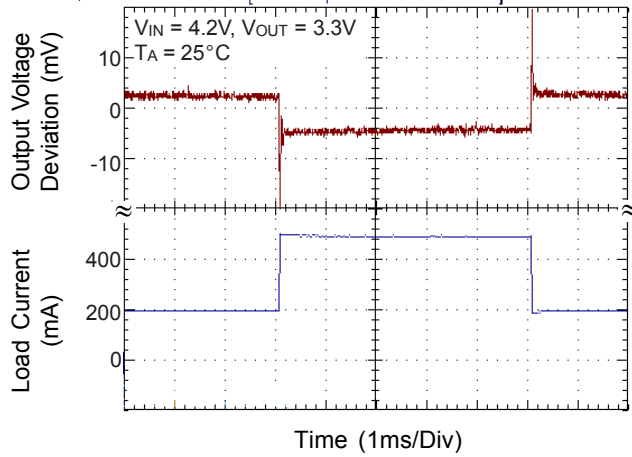

Application Information

The RT9902 is a four-channel DC/DC converter with one linear controller for digital still cameras and other hand-held device. The four channels DC/DC converters are as follows:

CH1: Step-up, asynchronous current mode DC/DC converter with an internal power MOSFET, current limit protection and high efficiency control for wide loading range.

CH2: Step-down, synchronous current mode DC/DC converter with internal power MOSFETs, current limit, short-circuit , over voltage protection and high efficiency control for wide loading range.

CH3: Step-down, synchronous current mode DC/DC converter with internal power MOSFETs, current limit, short-circuit protection and high efficiency control for wide loading range.

CH4: Charge pump DC/DC converter.

Soft-Start

CH1, CH2 and CH3 can be soft-started individually every time when the channel is enabled. Soft-start is achieved by ramping up the voltage reference of each channel's input of error amplifier. Adding a capacitor on SS pin to ground sets the ramping up speed of each voltage reference. Triangle wave will be appeared on SS pin, which provides a clock base for soft-start.

The soft-start timing would be setted by following formular.

$$T_{SS} = 10 \times \frac{C_{SS}}{1nF} \text{ (ms)}$$

Oscillator

The internal oscillator synchronizes CH1, CH2 and CH3 PWM operation frequency. The operation frequency is set by a resistor between RT pin to ground, ranging from 550kHz to 1.4MHz.

Step-up (Boost) DC/DC Converter (CH1)

The step-up channel (CH1) is designed as current-mode DC/DC PWM converters with built-in internal power MOS and external schottky diode. Output voltage is regulated and adjustable up to 5.5V. This channel typically supplies 3.3V for main system power.

At light load, efficiency is enhanced by pulse-skipping mode. In this mode, the NMOS turns on by a constant pulse width. As loading increased, the converter operates at constant frequency PWM mode. The maximum duty of the constant frequency is 80% for the boost to prevent high input current drawn from input.

Protection

Current Limit

The current of NMOS is sensed cycle by cycle to prevent over current. If the current is higher than 2.6A (typical), then the NMOS is off . This state is latched and then reset automatically at next clock cycle.

Under Voltage

The status of under voltage is decided by comparing FB1 voltage with 0.4V. This function is enabled after soft-start finishes. If the FB1 voltage is less than 0.4V, then the NMOS will be turned off immediately. And this state is latched. After a dummy count period, the controller begins a re-soft-start procedure.

If the status of under voltage remains after 4 successive times of soft-start, then CH1 is latched.

Over Voltage

The over voltage protection is used when the output of CH1 supplies the power of the main chip. If the output voltage of CH1 is over 6.5V, the main chip is shutdown and the NMOS is kept off.

Step-Down (Buck) DC/DC Converter (CH2, CH3)

The step-down channels (CH2, CH3) are designed as synchronous current-mode DC/DC PWM converters. Output voltage is regulated and adjustable down to 0.8V. The internal synchronous power switches eliminate the typical schottky free wheeling diode and improve efficiency.

At light load, efficiency is enhanced by pulse-skipping mode. In this mode, the high-side PMOS turns on by a constant pulse width. As loading increased, the converter operates at constant frequency PWM mode. While the input voltage is close to output voltage, the converter enters low dropout mode. Duty could be as long as 100% to extend battery life.

Protection

Current Limit (CH2, CH3)

The current of high-side PMOS is sensed cycle by cycle to prevent over current. If the current is higher than 1.5A (typical), then the high-side PMOS is off and the low-side NMOS is on. This state is latched and then reset automatically at next clock cycle.

Under Voltage (CH2, CH3)

The status of under voltage is decided by comparing FB2 (or FB3) voltage with 0.4V. This function is enabled after soft-start finishes. If the FB2 (or FB3) voltage is less than 0.4V, then the high/low-side power MOS are turned off immediately. And this state is latched. After a dummy count period, the CH2 (or CH3) begins a soft-start procedure.

However, if the status of under voltage remains after 3 successive times of soft-start, then CH2 (or CH3) is latched.

	UV remain after 3 successive soft-start	How to reset?
CH2	CH2 is latched, and whole IC is shut down	Toggle ENM
CH3	CH3 is latched	Toggle EN3 or ENM

Over Voltage Protection (CH2)

Over voltage protection (OVP) is used to protect the external parts connected to the output of CH2. If the FB2 voltage is higher than 1V, the high-side PMOS is off and low-side NMOS is on. This status is latched and could be reset by toggling ENM.

Charge Pump DC/DC Converter

This is a low quiescent charge pump DC/DC converter, which is enabled by ENM. Add a capacitor C_X (~1nF) between charge pump V_{OUT} and CP_{FB} to speed up charge pump response time. Output ripple can be easily suppressed by increasing the capacitance ratio of C_{OUT} and C_{CP} . This charge pump DC/DC converter can apply to μC standby power or the gate driver power of IGBT for photoflash, etc.

The maximum output current can be determined by C_{CP} and C_{OUT} ration. This equation would describe the relationship.

$$I_{MAX} = 2 \times (V_{DDC} - V_F) \times C_{CP} \times F_{CP}$$

- V_F : Schottky diode forward voltage
 - F_{pump} : Charge pump maximum frequency is 500kHz
- Recommand $C_{CP} \leq 0.1\mu F$.

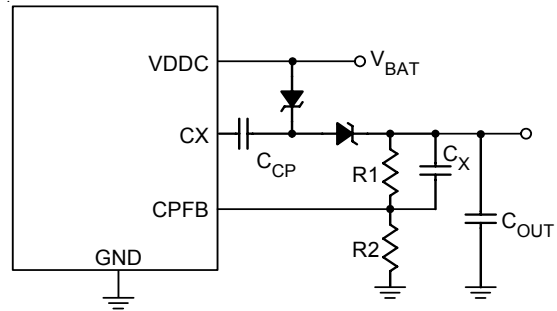

Reference

The chip has an internal 0.8V reference voltage, which is the inputs of the error amplifiers of the CH1, CH2, and CH3 to compare the difference of feedback voltage. The reference voltage can be set up stably when the supplied power (V_{DDM}) is above 1.5V, and EN1 (or EN2, EN3) goes high.

Thermal Protection

Thermal protection function is integrated in the chip. When the chip temperature is higher than 178 °C, the controllers of CH1, CH2, and CH3 are shutdown. 10°C is the hysteresis range of temperature to prevent unstable operation when the thermal protection happens. When the thermal protection is relieved, the chip operates well again.

Outline Dimension

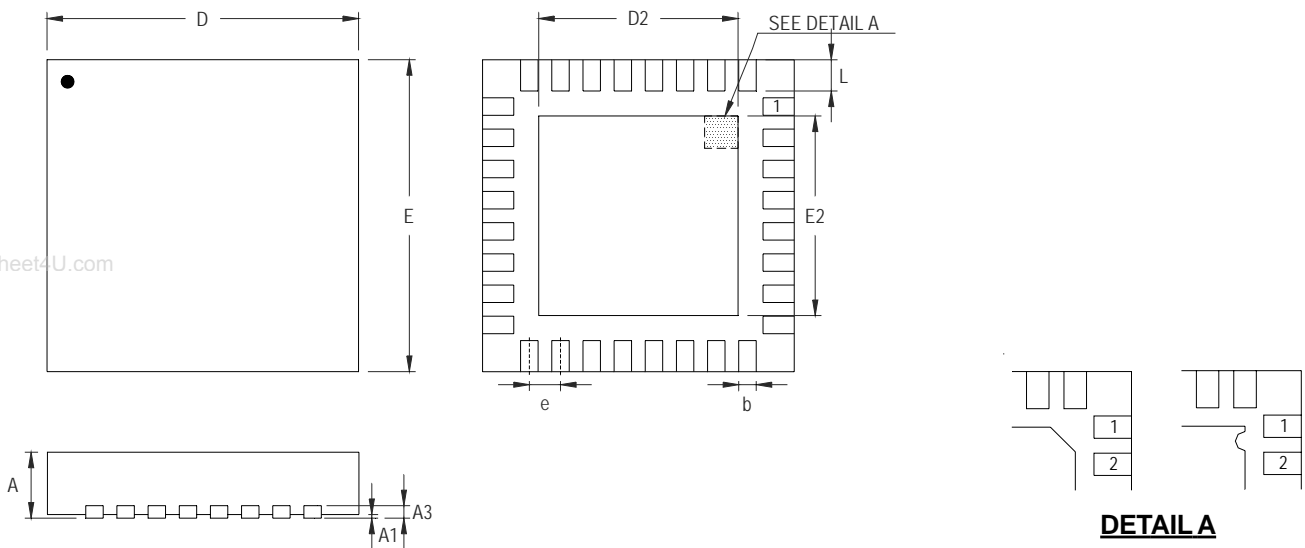

DETAIL A

Pin #1 ID and Tie Bar Mark Options

Note : The configuration of the Pin #1 identifier is optional, but must be located within the zone indicated.

Symbol	Dimensions In Millimeters		Dimensions In Inches	
	Min	Max	Min	Max
A	0.800	1.000	0.031	0.039
A1	0.000	0.050	0.000	0.002
A3	0.175	0.250	0.007	0.010
b	0.180	0.300	0.007	0.012
D	4.950	5.050	0.195	0.199
D2	3.400	3.750	0.134	0.148
E	4.950	5.050	0.195	0.199
E2	3.400	3.750	0.134	0.148
e	0.500		0.020	
L	0.350	0.450	0.014	0.018

V-Type 32L QFN 5x5 Package

Richtek Technology Corporation

Headquarter
5F, No. 20, Taiyuen Street, Chupei City
Hsinchu, Taiwan, R.O.C.
Tel: (8863)5526789 Fax: (8863)5526611

Richtek Technology Corporation

Taipei Office (Marketing)
8F, No. 137, Lane 235, Paochiao Road, Hsintien City
Taipei County, Taiwan, R.O.C.
Tel: (8862)89191466 Fax: (8862)89191465
Email: marketing@richtek.com