

7 Channel DC/DC Converters

General Description

The RT9919 is a complete power supply solution for digital still cameras and other hand held devices. The RT9919 is a multi-channel DC/DC converter including two step-up DC/DC converters, two step-down DC/DC converters, one selectable step-up/step-down DC/DC converter, one inverting DC/DC converter and one WLED driver.

The RT9919 is designed to fulfill the applications for DSC just as follows :

CH1 is a synchronous step-up output for motor or DSC system I/O power

CH2 is a selectable synchronous step-up/step-down output for motor or DSC system I/O power

CH3 and CH4 are synchronous step-down outputs for DSP core and memory power supply

CH5 is a high voltage step-up output for CCD bias power supply

CH6 is an inverting output for negative CCD bias power supply

CH7 is a high voltage step-up output for driving WLED

For the selectable step-up/step-down converter, the Boost/Buck can be selected by the SEL pin. Among all channels, there are 5 channels with the built-in internal compensation. The RT9919 also provides a transformerless inverting converter for supplying the CCD power. For the synchronous step-up and step down converters, the efficiency can be up to 95%. The IC provides load disconnection for channel 1 and channel 5. The IC has selectable RTC_LDO/SW1 that can be determined by the CN pin.

The RT9919 is able to support Li+ and 2AA battery applications. The RT9919 provides WLED open protection, current limit, thermal shutdown protection, over voltage and under voltage protection to achieve complete protection. The RT9919 is available in WQFN-40L 5x5 package.

Features

- | 1 Channel Syn Boost/Buck Selectable
- | 2AA/Li Application Topologies Set by SEL Pin
- | Preset On/Off Sequence
- | 5 Channels with Internal Compensation
- | All Power Switches Integrated
- | Syn Step-Down DC/DC Converter :
 - } Up to 95% Efficiency
 - } 100% (max) Duty Cycle
- | Syn Step-Up DC/DC Converter :
 - } Adjustable Output Voltage
 - } Up to 95% Efficiency
- | Open LED Protection
- | Transformerless Inverting Converter for CCD
- | Fixed 2MHz Switching Frequency at CH1 to CH4
- | Fixed 1MHz Switching Frequency at CH5 to CH7
- | RTC_LDO/SW1 Selectable by CN Pin
- | 40-Lead WQFN Package
- | RoHS Compliant and Halogen Free

Applications

- | Digital Still Camera
- | PDA
- | Portable Device

Ordering Information

RT9919 □ □

└─ Package Type
 QW : WQFN-40L 5x5 (W-Type)

└─ Lead Plating System
 G : Green (Halogen Free and Pb Free)

Note :

Richtek products are :

- } RoHS compliant and compatible with the current requirements of IPC/JEDEC J-STD-020.
- } Suitable for use in SnPb or Pb-free soldering processes.

Pin Configurations

(TOP VIEW)

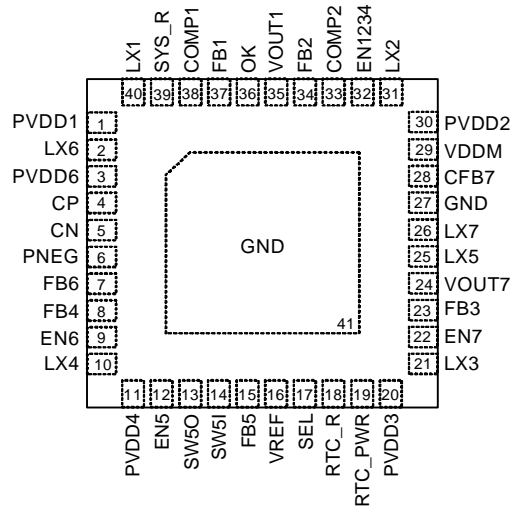

WQFN-40L 5x5

Typical Application Circuit

For 2AA

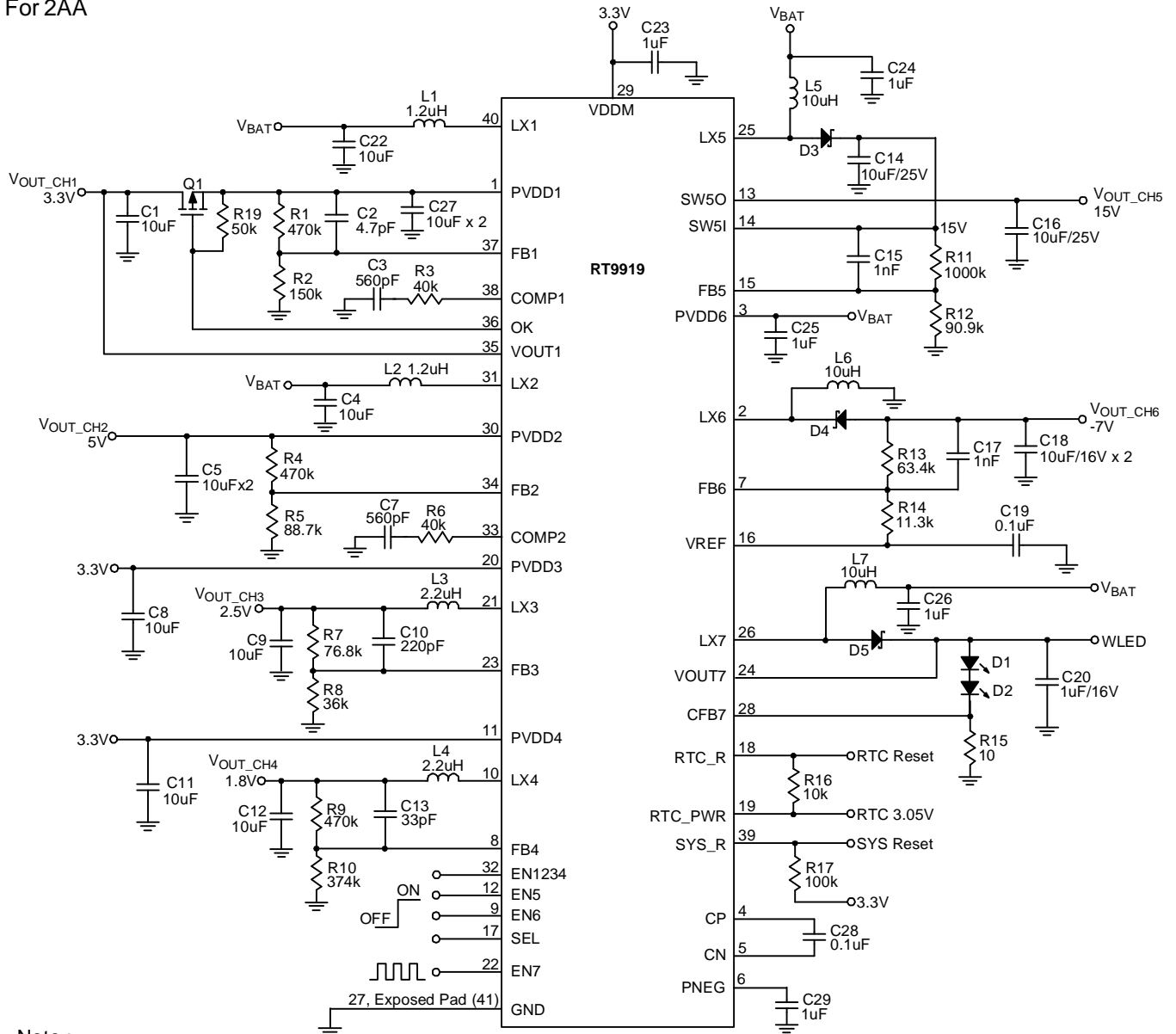

Note :

- (1) SEL = High, CH2 is Boost, CN Connect to CAP
- (2) V_{BAT} = 1.8V to 3.2V

Timing Diagram

Power On Sequence : CH1 Boost 3.3V→CH3 Buck 2.5V→CH4 Buck 1.8V→(CH2 Boost 5V and SW1 3.3V)

Power Off Sequence : (CH2 Boost 5V and SW1 3.3V)→ CH4 Buck 1.8V→ CH3 Buck 2.5V→ CH1 Boost 3.3V

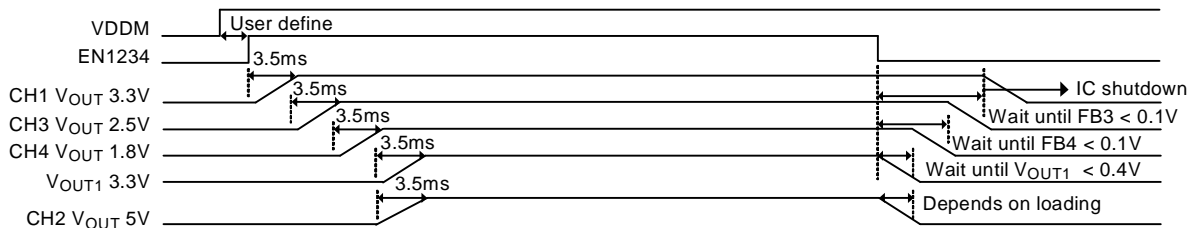

For Li-ion

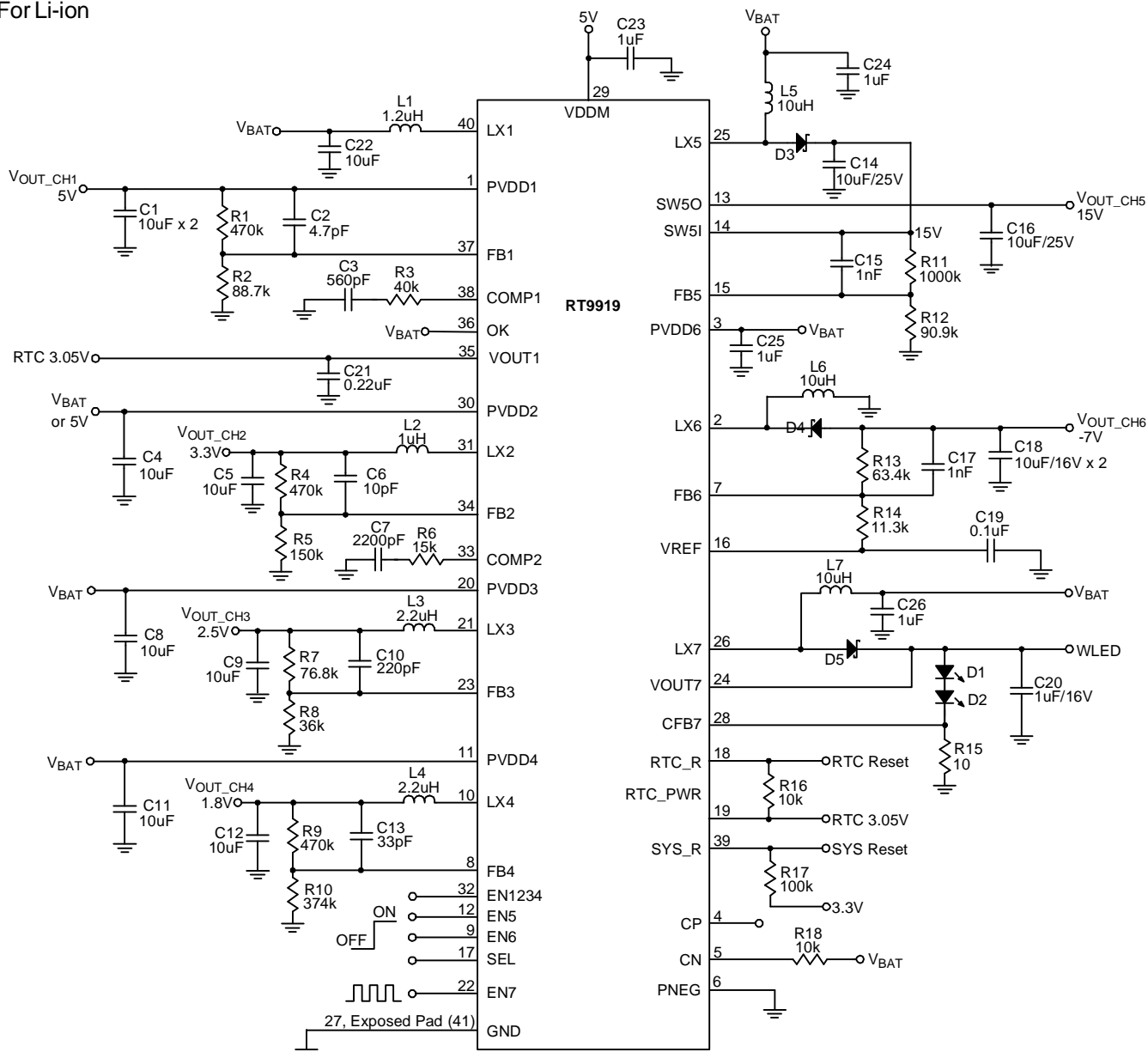

Note :

- (1) SEL = Low, CH2 is Buck, CN Pull High
- (2) V_{BAT} = 2.7V to 4.2V

Timing Diagram

Power On Sequence : CH1 Boost 5V → CH3 Buck 2.5V → CH4 Buck 1.8V → CH2 Buck 3.3V

Power Off Sequence : CH2 Buck 3.3V → CH4 Buck 1.8V → CH3 Buck 2.5V → CH1 Boost 5V

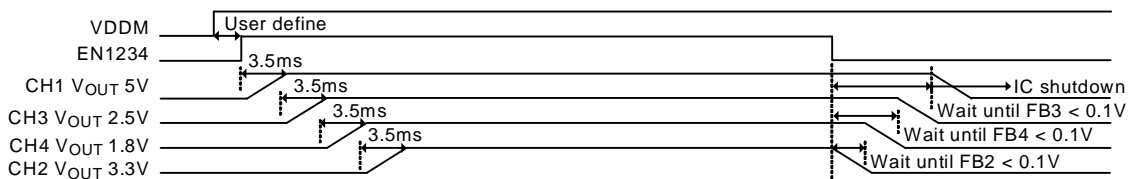

Table 1

Channel	CH3					
Formula	$V_{OUT} = (1+R7/R8) \times 0.8$					
V_{OUT} (V)	2.5	1.8	1.5	1.3	1.2	1.0
L3 (uH)	2.2	2.2	2.2	2.2	2.2	2.2
R7 (kΩ)	768	470	330	237	187	23.2
R8 (kW)	360	374	374	374	374	93.1
C10 (pF)	22	33	47	68	82	47
C_{OUT} (uF)	10	10	10	10	10	10

Channel	CH4					
Application	$V_{OUT} = (1+R9/R10) \times 0.8$					
V_{OUT} (V)	2.5	1.8	1.5	1.3	1.2	1.0
L4 (uH)	2.2	2.2	2.2	2.2	2.2	2.2
R9 (kW)	768	470	330	237	187	23.2
R10 (kW)	360	374	374	374	374	93.1
C13 (pF)	22	33	47	68	82	47
C_{OUT} (uF)	10	10	10	10	10	10

Channel	CH5					
Formula	$V_{OUT} = (1+R11/R12) \times 1.25$					
V_{OUT} (V)	12	13	14	15	15.5	16
L5 (uH)	10	10	10	10	10	10
R11 (kW)	820	820	953	1000	820	887
R12 (kW)	95.3	86.6	93.1	90.9	71.5	75
C15 (pF)	1000	1000	1000	1000	1000	1000
C_{OUT} (uF)	10/16V	10/16V	10/25V	10/25V	10/25V	10/25V

Channel	CH6				
Formula	$V_{OUT} = (R13/R14) \times (-1.25)$ * R13+R14 <90k				
V_{OUT} (V)	-6	-6.3	-7	-7.5	-8
L6 (uH)	10	10	10	10	10
R13 (kW)	57.6	69.8	63.4	68	68
R14 (kW)	12	13.7	11.3	11.3	10.5
C17 (pF)	1000	1000	1000	1000	1000
C_{OUT} (uF)	10 x 2pcs	10 x 2pcs	10 x 2pcs	10 x 2pcs	10 x 2pcs

Functional Pin Description

Pin No.	Pin Name	Pin Function
1	PVDD1	Power Input pin of CH1.
2	LX6	Switch Node of CH6. High impedance in shutdown.
3	PVDD6	Power Input Pin of CH6.
4	CP	Charge Pump External Driver Pin.
5	CN	Charge Pump External Driver Pin.
6	PNEG	Negative Output Pin of Charge Pump.
7	FB6	Feedback Input Pin of CH6. High impedance in shutdown.
8	FB4	Feedback Input Pin of CH4. High impedance in shutdown.
9	EN6	Enable Pin of CH6.
10	LX4	Switch Node of CH4. High impedance in shutdown.
11	PVDD4	Power Input Pin of CH4.
12	EN5	Enable Pin of CH5.
13	SW5O	Output Pin of CH5 Load Disconnect.
14	SW5I	Input Pin of CH5 Load Disconnect.
15	FB5	Feedback Input Pin of CH5. High impedance in shutdown.
16	VREF	1.25V Reference Output Pin.
17	SEL	Li or 2AA Select Pin. Logic state can not be changed during operation.
18	RTC_R	RTC Reset Output Pin.
19	RTC_PWR	Power Input Pin of RTC-Reset.
20	PVDD3	Power Input Pin of CH3
21	LX3	Switch Node of CH3. High impedance in shutdown.
22	EN7	Enable Pin of CH7.
23	FB3	Feedback Input Pin of CH3. High impedance in shutdown.
24	VOU7	Sense Pin for CH7 Output Voltage.
25	LX5	Switch Node of CH5. High impedance in shutdown.
26	LX7	Switch Node of CH7. High impedance in shutdown.
27, 41 (Exposed Pad)	GND	Ground Pin. The exposed pad must be soldered to a large PCB and connected to GND for maximum thermal dissipation.
28	CFB7	Feedback Input Pin of CH7.
29	VDDM	IC analog Input Power Pin.
30	PVDD2	Power Input Pin of CH2.
31	LX2	Switch Node of CH2. High impedance in shutdown.
32	EN1234	Enable Pin of CH1, CH2, CH3 and CH4.
33	COMP2	Compensation Pin of CH2.
34	FB2	Feedback input pin of CH2. High impedance in shutdown.
35	VOU1	Sense Pin for CH1 Output Voltage. High impedance in shutdown.
36	OK	External Switch Control Pin. High impedance in shutdown.
37	FB1	Feedback Input Pin of CH1. High impedance in shutdown.
38	COMP1	Compensation Pin of CH1. Pull to GND in shutdown.
39	SYS_R	System Reset Output Pin.
40	LX1	Switch Node of CH1. High impedance in shutdown.

Function Block Diagram

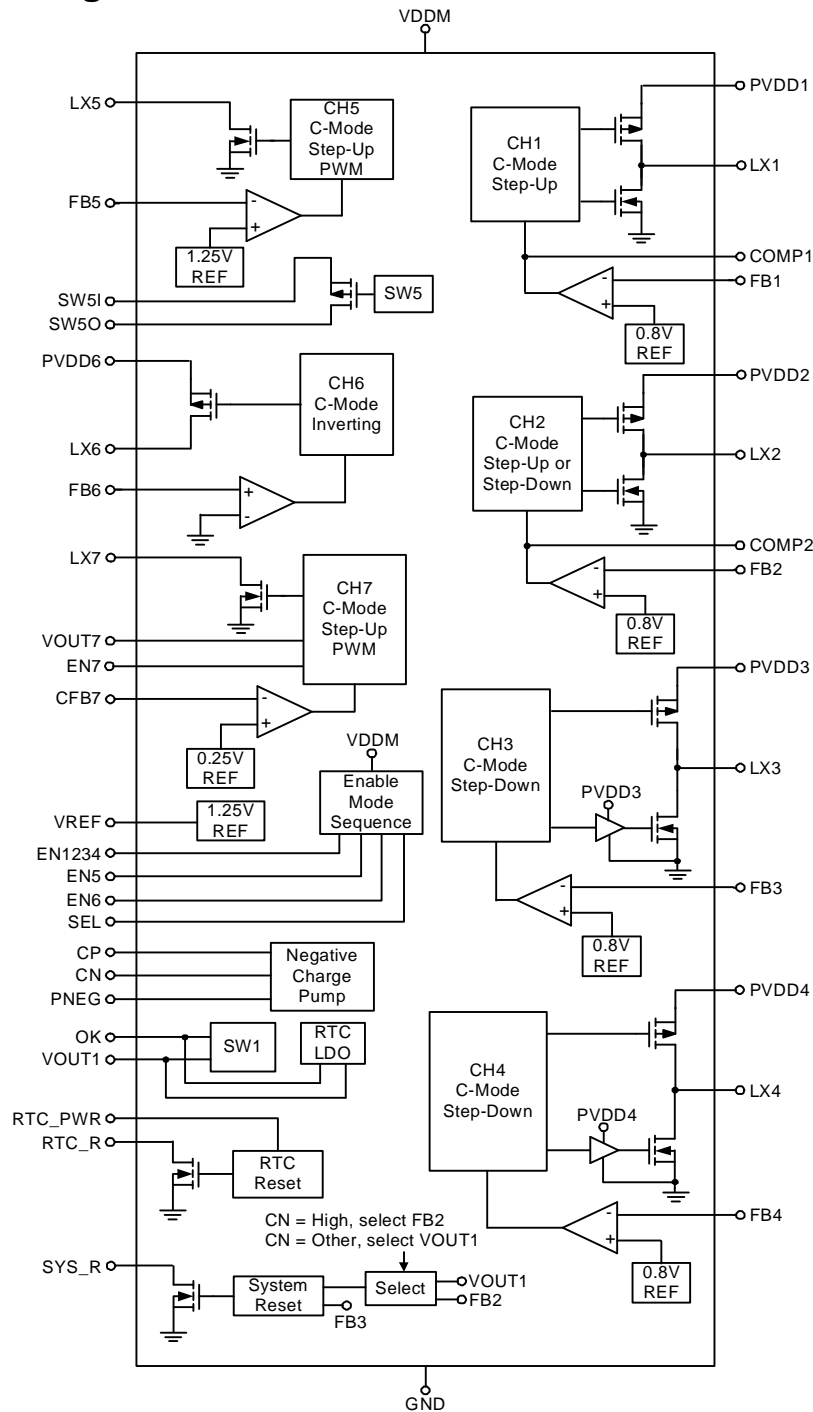

Timing Diagram

CH5 and CH6 Timing Diagram

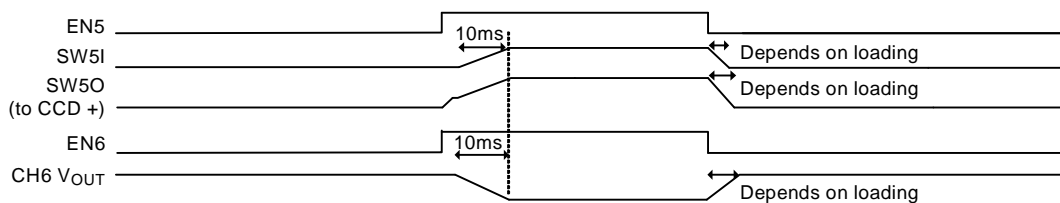

Absolute Maximum Ratings (Note 1)

- | Supply Voltage, V_{DDM} ----- 0.3V to 7V
- | Power Switch :
 - LX1, LX2, LX4 ----- -0.3V to 6.5V
 - LX5, LX7, SW5I, SW5O, VOUT7 ----- -0.3V to 21V
 - LX6 ----- (PVDD6 - 14V) to (PVDD6 + 0.3V)
- | The Other Pins ----- -0.3V to 6.5V
- | Power Dissipation, P_D @ $T_A = 25^\circ\text{C}$
 - WQFN 40L 5x5 ----- 2.778W
- | Package Thermal Resistance (Note 2)
 - WQFN 40L 5x5, θ_{JA} ----- 36°C/W
 - WQFN 40L 5x5, θ_{JC} ----- 7°C/W
- | Junction Temperature ----- 150°C
- | Lead Temperature (Soldering, 10 sec.) ----- 260°C
- | Storage Temperature Range ----- -65°C to 150°C
- | ESD Susceptibility (Note 3)
 - HBM (Human Body Mode) ----- 2kV
 - MM (Machine Mode) ----- 200V

Recommended Operating Conditions (Note 4)

- | Junction Temperature Range ----- -40°C to 125°C
- | Ambient Temperature Range ----- -40°C to 85°C

Electrical Characteristics

($V_{DDM} = 3.3\text{V}$, $T_A = 25^\circ\text{C}$, unless otherwise specified)

Parameter	Symbol	Test Condition	Min	Typ	Max	Units
Supply Voltage						
VDDM Operating Voltage	V_{DDM}		2.7	--	5.5	V
VDDM Minimum Startup Voltage	V_{ST}		1.5	--	--	V
VDDM Over Voltage Protection			5.6	6	6.5	V
Supply Current						
Shutdown Supply Current into VDDM	I_{OFF}	All EN = 0, CN = 3.3V	--	1	10	μA
CH1 (Syn-Boost) : Supply Current into VDDM	I_{Q1}	Non Switching, EN1234 = 3.3V	--	--	800	μA
CH2 (Syn-Boost or Syn-Buck) : Supply Current into VDDM	I_{Q2}	Non Switching, EN1234 = 3.3V	--	--	800	μA
CH3 (Syn-Buck) : Supply Current into VDDM	I_{Q3}	Non Switching, EN1234 = 3.3V	--	--	800	μA
CH4 (Syn-Buck) : Supply Current into VDDM	I_{Q4}	Non Switching, EN1234 = 3.3V	--	--	800	μA
CH5 (Asyn-Boost) : Supply Current into VDDM	I_{Q5}	Non Switching, EN5 = 3.3V	--	--	800	μA
CH6 (Inverting) + Charge pump : Supply Current into VDDM	I_{Q6}	Non Switching, EN6 = 3.3V PVDD6 = 3.3V	--	--	800	μA
CH7 (WLED): Supply Current into VDDM	I_{Q7}	Non Switching, EN7 = 3.3V	--	--	800	μA

To be continued

Parameter	Symbol	Test Condition	Min	Typ	Max	Units
Oscillator						
CH1,2,3,4 Operating Frequency	f _{OSC}		1800	2000	2200	kHz
CH5, 6, 7 Operating Frequency	f _{OSC2}		900	1000	1100	kHz
CH1 Maximum Duty Cycle (Boost)		V _{FB1} = 0.7V	80	83	86	%
CH2 Maximum Duty Cycle (Boost)		V _{FB2} = 0.7V	80	83	86	%
CH2 Maximum Duty Cycle (Buck)		V _{FB2} = 0.7V	--	--	100	%
CH3 Maximum Duty Cycle (Buck)		V _{FB3} = 0.7V	--	--	100	%
CH4 Maximum Duty Cycle (Buck)		V _{FB4} = 0.7V	--	--	100	%
CH5 Maximum Duty Cycle (Boost)		V _{FB5} = 1.15V	91	94	97	%
CH6 Maximum Duty Cycle (Inverting)		V _{FB6} = 0.1V	91	94	97	%
CH7 Maximum Duty Cycle (WLED)		C _{FB7} = 0.15V	91	94	97	%
Feedback Regulation Voltage						
Feedback Regulation Voltage @ FB1, FB2, FB3, FB4			0.788	0.8	0.812	V
Feedback Regulation Voltage @ FB5			1.237	1.25	1.263	V
Feedback Regulation Voltage @ FB6 (Inverting)			-15	0	15	mV
Feedback Regulation Voltage @ CFB7			0.237	0.25	0.263	V
OK Sink Current		OK = 1V	60	--	--	uA
Reference						
VREF Output Voltage	V _{REF}		1.237	1.25	1.263	V
VREF Load Regulation		0uA < I _{REF} < 200uA	--	--	10	mV
Negative Charge Pump						
PVDD6 High Threshold to Stop Pump			3.9	4	4.2	V
PVDD6 Low Threshold to Stop Pump			3.4	3.6	3.8	V
(PVDD6 – PNEG) Clamped Voltage		PVDD6 = 3.3V	4.1	4.5	4.9	V
Power Switch						
CH1 On Resistance of MOSFET	R _{DS(ON)}	P-MOSFET, PVDD1 = 3.3V	--	150	--	mΩ
		N-MOSFET, PVDD1 = 3.3V	--	150	--	mΩ
CH1 Current Limitation (Boost)			--	3	--	A
CH2 On Resistance of MOSFET	R _{DS(ON)}	P-MOSFET, PVDD2 = 3.3V	--	150	--	mΩ
		N-MOSFET, PVDD2 = 3.3V	--	150	--	mΩ
CH2 Current Limitation (Buck)			--	1.5	--	A
CH2 Current Limitation (Boost)			--	3	--	A
CH3 On Resistance of MOSFET	R _{DS(ON)}	P-MOSFET, PVDD3 = 3.3V	--	200	--	mΩ
		N-MOSFET, PVDD3 = 3.3V	--	200	--	mΩ
CH3 Current Limitation (Buck)			--	1.5	--	A
CH4 On Resistance of MOSFET	R _{DS(ON)}	P-MOSFET, PVDD4 = 3.3V	--	200	--	mΩ
		N-MOSFET, PVDD4 = 3.3V	--	200	--	mΩ
CH4 Current Limitation (Buck)			--	1.5	--	A
CH5 Load Disconnect MOSFET		P-MOSFET, SW5I = 3.3V	--	0.5	--	Ω
CH5 On Resistance of MOSFET		N-MOSFET	--	0.5	--	Ω
CH5 Current Limitation		N-MOSFET	--	1.2	--	A

To be continued

Parameter	Symbol	Test Condition	Min	Typ	Max	Units
CH6 On Resistance of MOSFET		P-MOSFET, PVDD6 = 3.3V	--	1	--	Ω
CH6 Current Limitation		P-MOSFET	--	1.5	--	A
CH7 On Resistance of MOSFET		N-MOSFET	--	0.5	--	Ω
CH7 Current Limitation		N-MOSFET	--	0.8	--	A
Protection						
Over Voltage Protection of PVDD1 and PVDD2			5.5	6	6.5	V
Over Voltage Protection Hysteresis of PVDD1 and PVDD2			--	--	0.6	V
Under Voltage Protection of VOUT1			--	1.75	--	V
Over Voltage Protection of SW5I			18	--	21	V
Over Voltage Protection of VOUT7			12	--	16	V
CH5 Load Disconnect UVP of SW5O			0.35	0.4	0.45	V
Under Voltage Protection of FB2			--	0.4	--	V
Under Voltage Protection of FB3			--	0.4	--	V
Under Voltage Protection of FB4			--	0.4	--	V
Protection Fault Delay			--	100	--	ms
Control						
EN1234, EN5, EN6, EN7 Input High Level Threshold			1.3	--	--	V
EN1234, EN5, EN6, EN7 Input Low Level Threshold			--	--	0.4	V
EN1234, EN5, EN6, EN7 Sink Current			--	2	6	μ A
SEL Input High Level Threshold			1.3	--	--	V
SEL Input Low Level Threshold			--	--	0.4	V
SEL Sink Current		SEL = 3.3V	--	3	9	μ A
SEL Sink Current		All EN = 0	--	0	--	μ A
Thermal Protection						
Thermal Shutdown	T_{SD}		125	160	--	$^{\circ}$ C
Thermal Shutdown Hysteresis	ΔT_{SD}		--	20	--	$^{\circ}$ C
System Reset						
FB2 Regulation Threshold		CN = 3.3V	0.709	0.72	0.731	V
Hysteresis			--	40	--	mV
FB3 Regulation Threshold			0.709	0.72	0.731	V
Hysteresis			--	40	--	mV
VOUT1 Regulation Threshold			2.95	3.0	3.05	V
Hysteresis			--	0.15	--	V
SYS_R Rising Delay Time			--	10	--	ms
SYS_R Sink Capability		SYS_R = 0.5V	4	--	--	mA

To be continued

Parameter	Symbol	Test Condition	Min	Typ	Max	Units
RTC Reset						
RTC_PWR Reset Threshold			1.57	1.6	1.63	V
Hysteresis			--	16	--	mV
Standby Current		RTC_PWR = 3V	--	2	4	uA
RTC_R Rising Delay Time			35	55	75	ms
RTC_R Sink Capability		RTC_R = 0.5V, RTC_PWR = 1.6V	4	--	--	mA
RTC LDO, CN = High						
Input Voltage Range	V _{IN}		--	--	5.5	V
Standby Current		V _{IN} = 4.2V	--	5	8	uA
Output Voltage	V _{OUT}	I _{OUT} = 0mA	--	3.05	--	V
Maximum Output Current		V _{IN} = 4.2V	60	--	--	mA
Dropout Voltage	V _{DROP}	I _{OUT} = 20mA	--	--	200	mV

Note 1. Stresses listed as the above "Absolute Maximum Ratings" may cause permanent damage to the device. These are for stress ratings. Functional operation of the device at these or any other conditions beyond those indicated in the operational sections of the specifications is not implied. Exposure to absolute maximum rating conditions for extended periods may remain possibility to affect device reliability.

Note 2. θ_{JA} is measured in the natural convection at $T_A = 25^\circ\text{C}$ on a high effective four layers thermal conductivity test board of JEDEC 51-7 thermal measurement standard. The case point of θ_{JC} is on the expose pad for the package.

Note 3. Devices are ESD sensitive. Handling precaution is recommended.

Note 4. The device is not guaranteed to function outside its operating conditions.

Typical Operating Characteristics

CH1 Boost Efficiency vs. Output Current

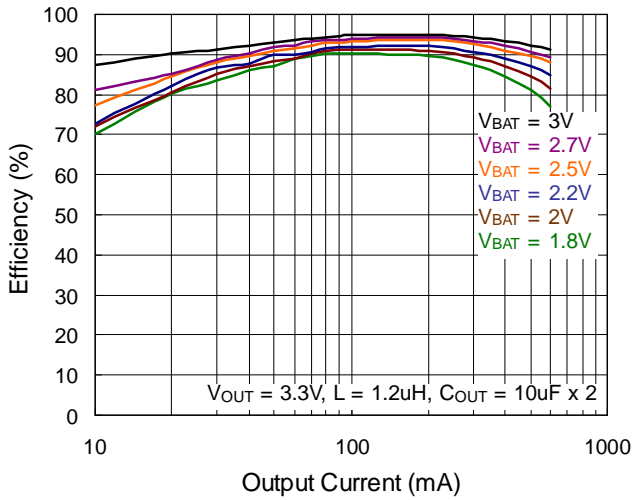

CH1 Boost Efficiency vs. Output Current

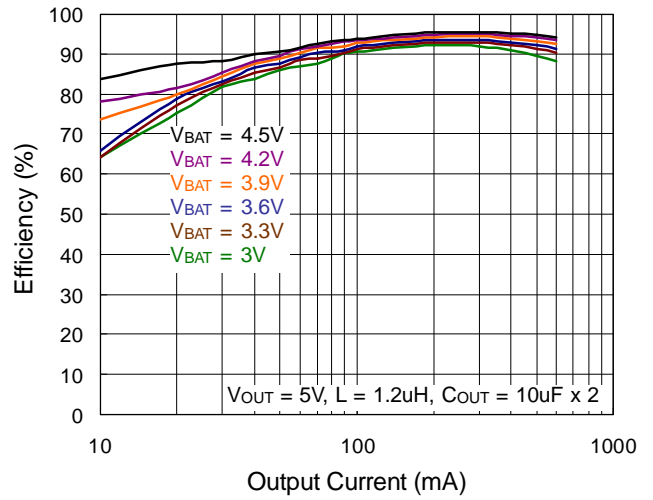

CH2 Boost Efficiency vs. Output Current

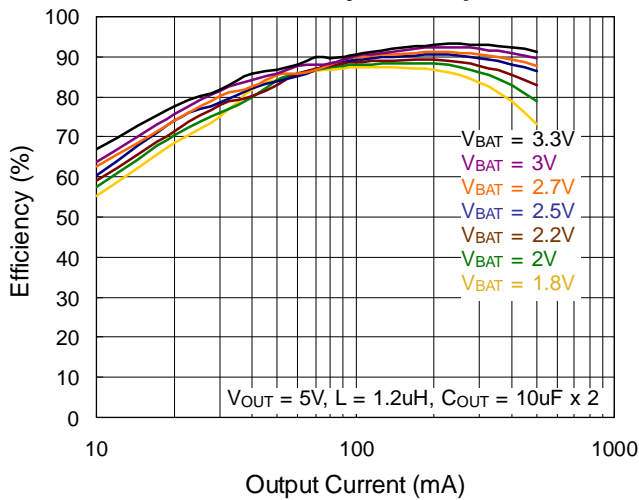

CH2 Buck Efficiency vs. Output Current

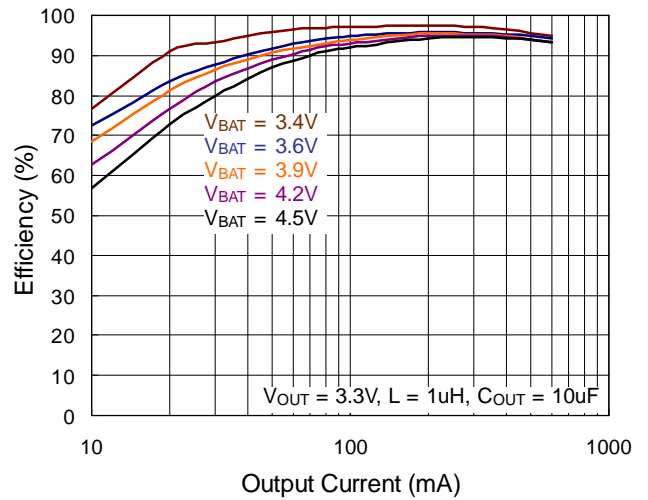

CH3 Buck Efficiency vs. Output Current

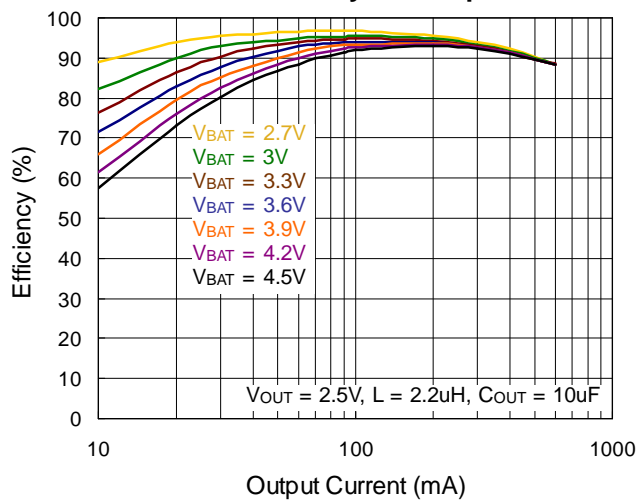

CH4 Buck Efficiency vs. Output Current

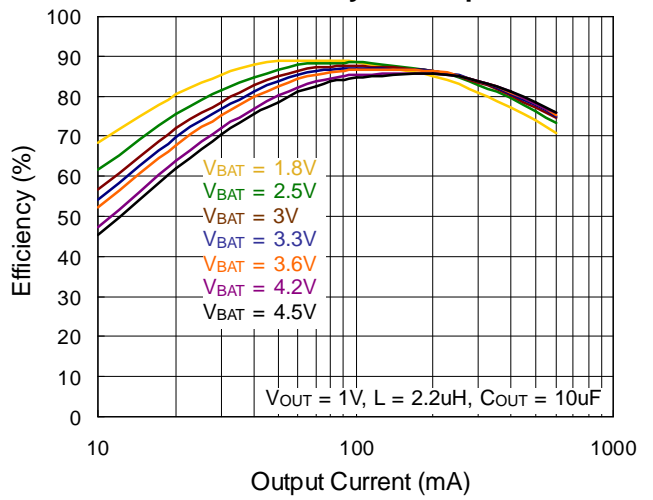

CH5 Boost Efficiency vs. Output Current

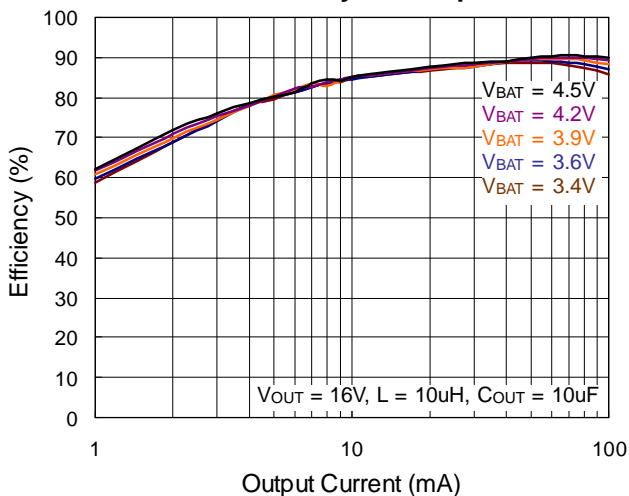

CH6 Inverting Efficiency vs. Output Current

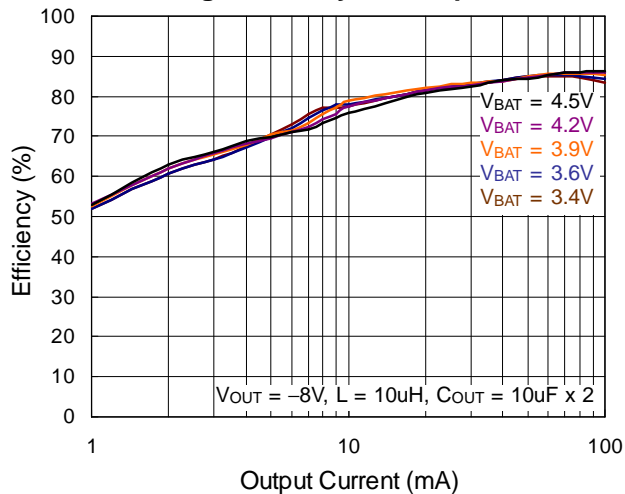

CH7 Efficiency vs. Input Voltage

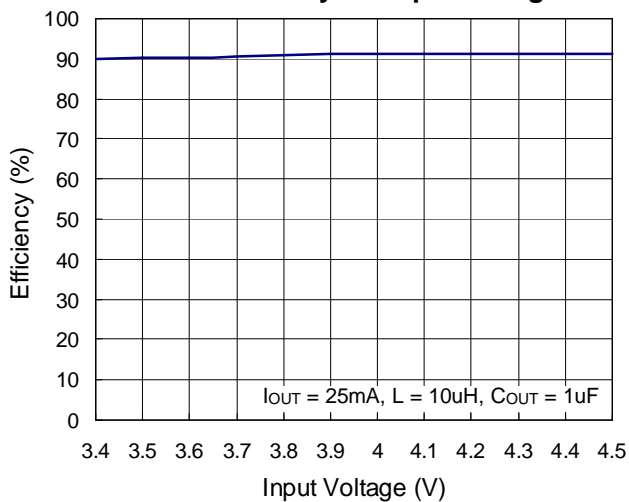

CH1 Boost Output Voltage vs. Output Current

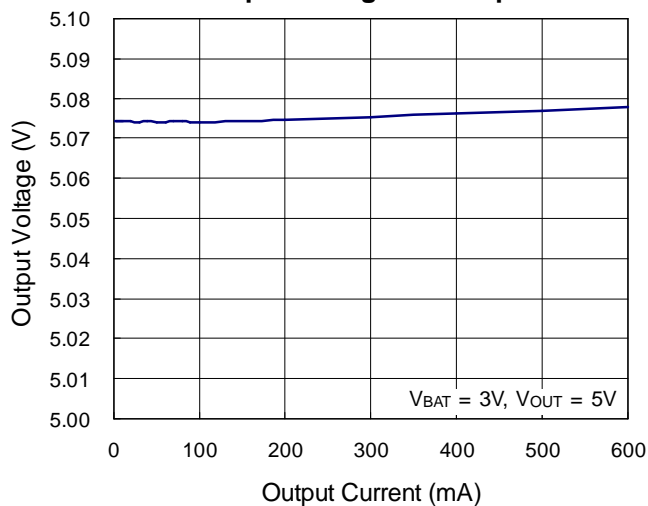

CH2 Buck Output Voltage vs. Output Current

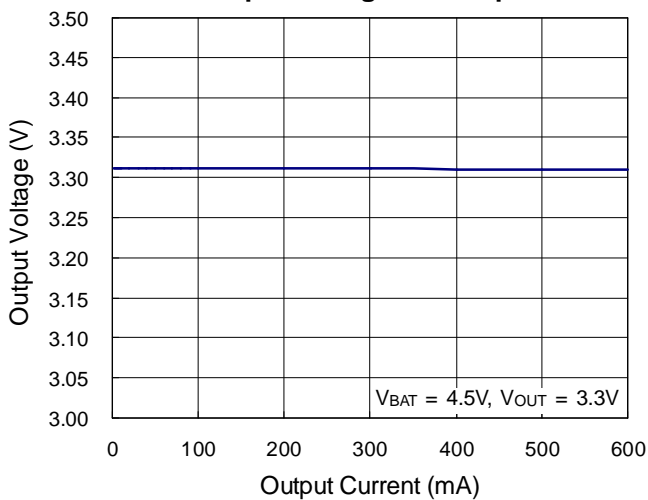

CH3 Buck Output Voltage vs. Output Current

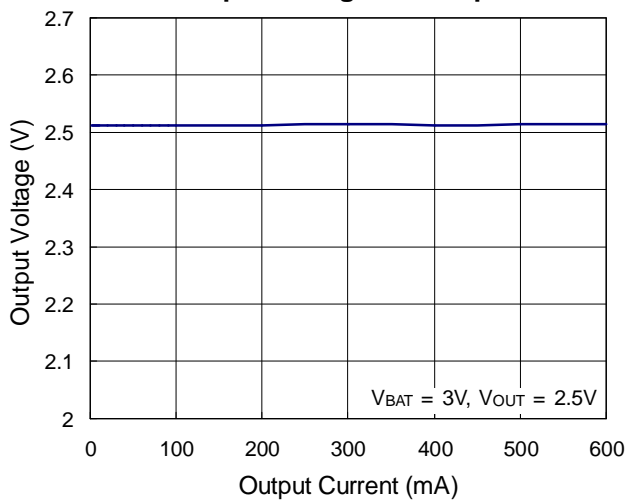

CH4 Buck Output Voltage vs. Output Current

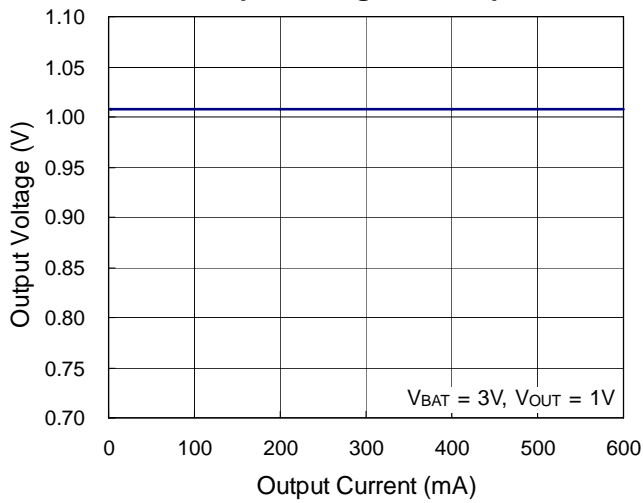

CH5 Boost Output Voltage vs. Output Current

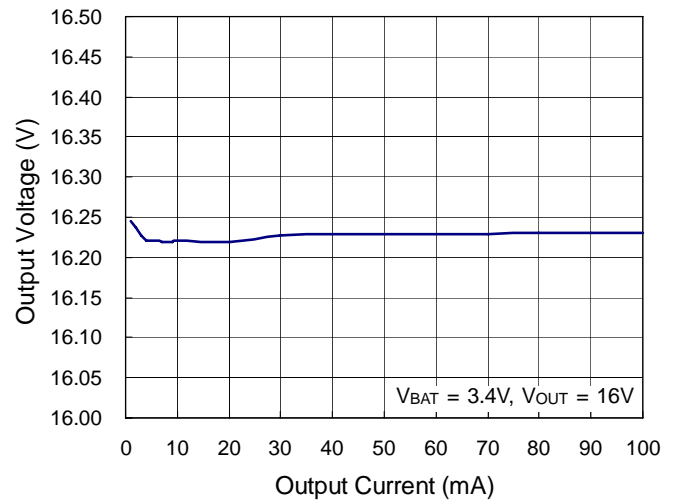

CH6 Inverting Output Voltage vs. Output Current

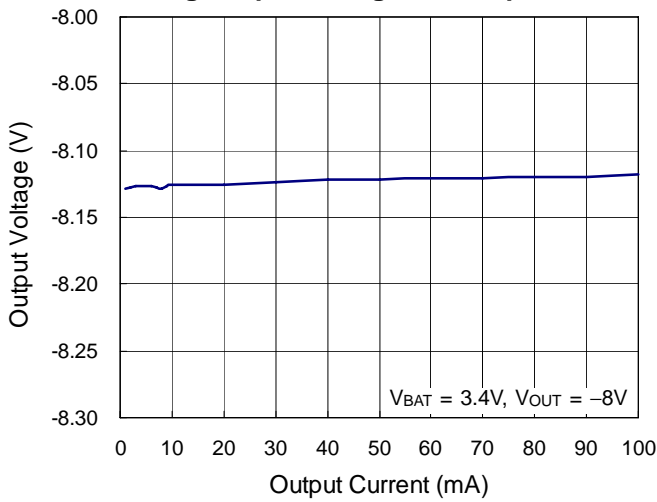

CH1, CH2, CH3 and CH4 Power On

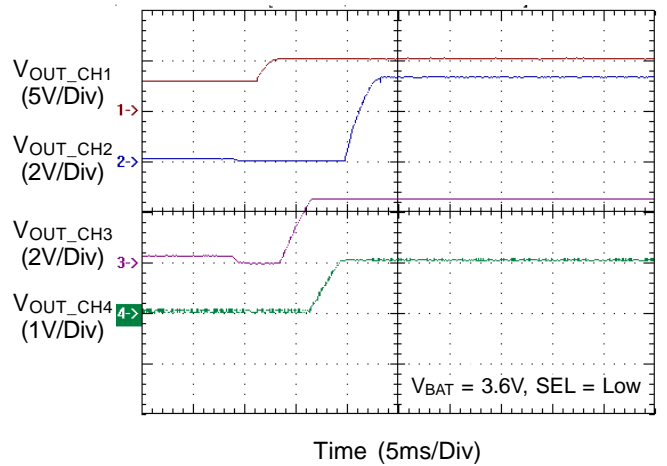

CH1, CH2, CH3 and CH4 Power Off

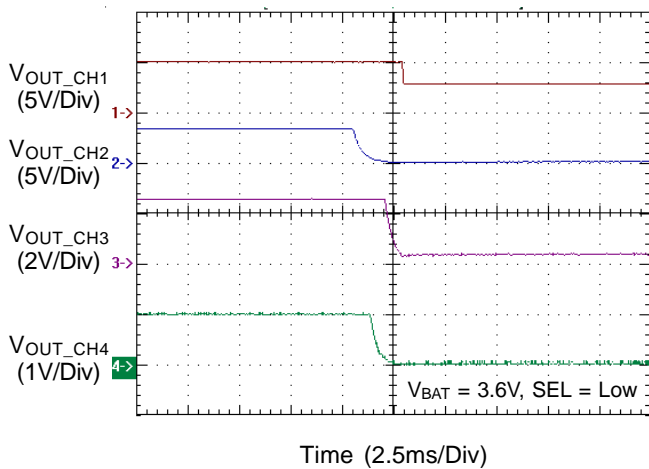

CH1, CH2, CH3 and CH4 Power On

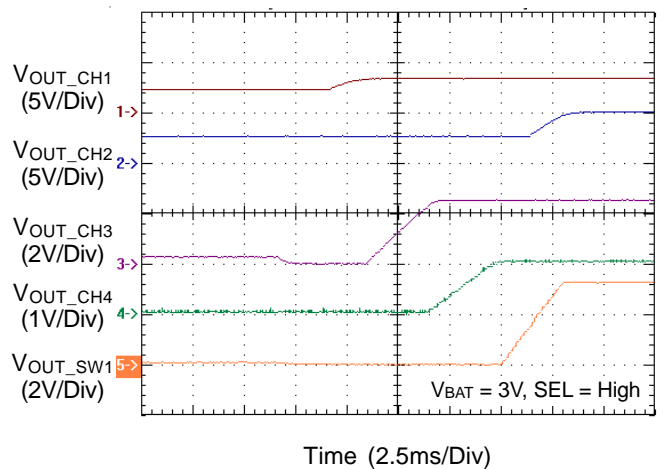

CH1, CH2, CH3 and CH4 Power Off

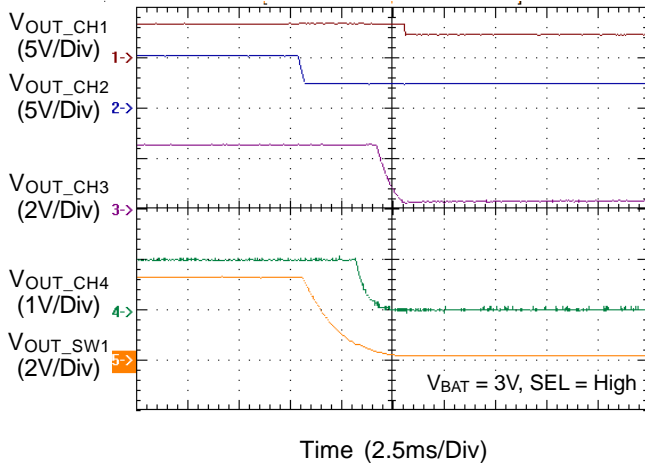

CH1 Output Voltage Ripple

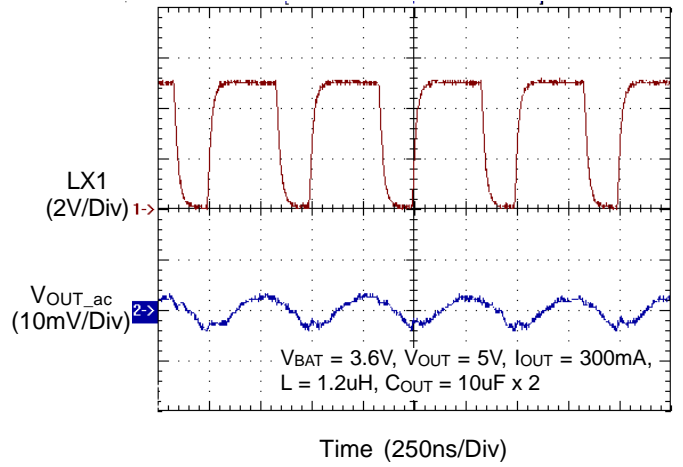

CH2 Output Voltage Ripple

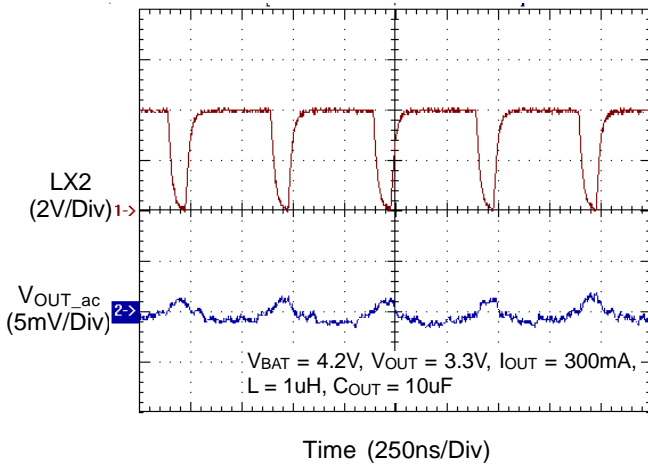

CH3 Output Voltage Ripple

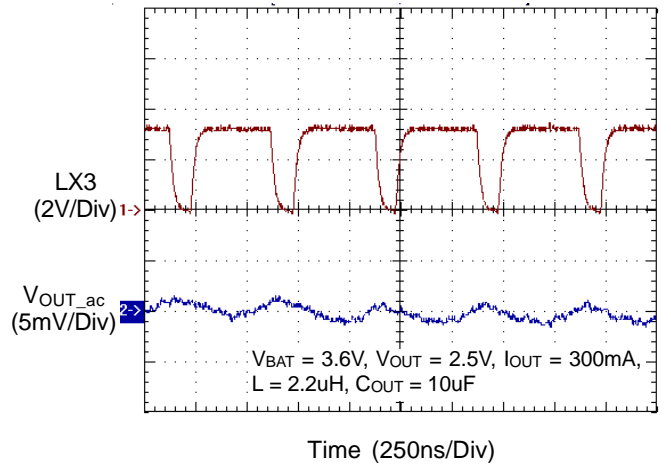

CH4 Output Voltage Ripple

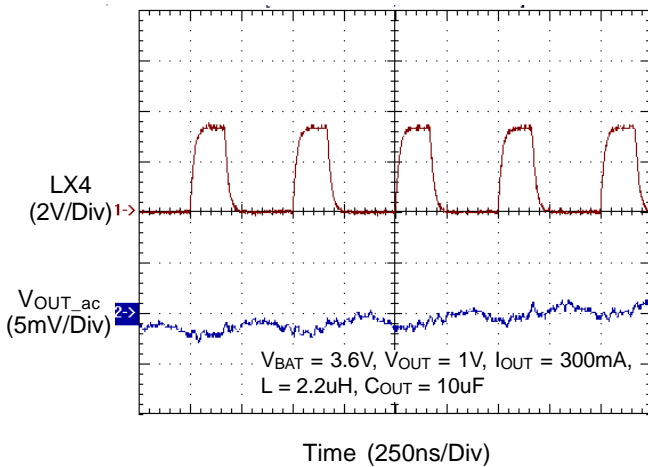

CH5 Output Voltage Ripple

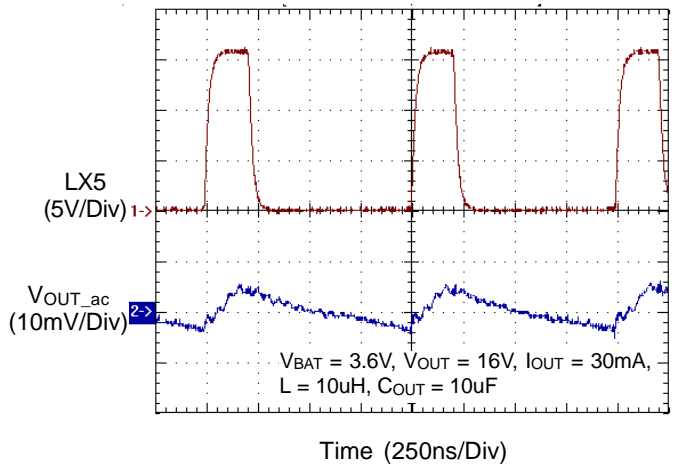

CH6 Output Voltage Ripple

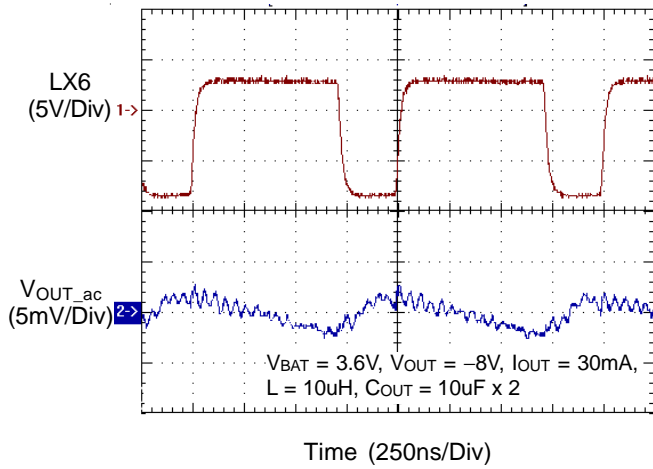

CH7 Output Voltage Ripple

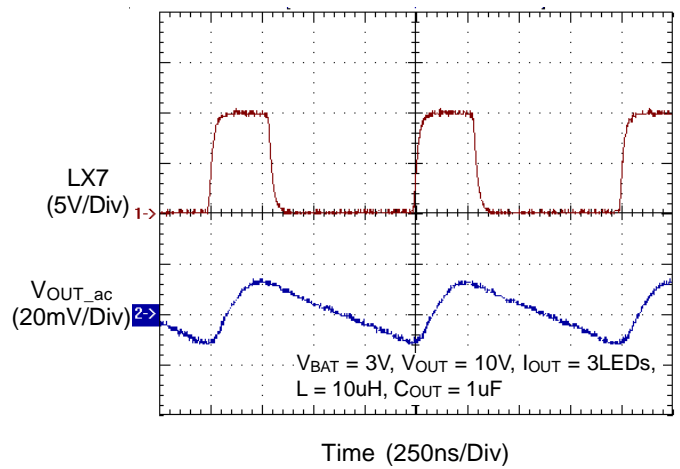

CH1 Load Transient Response

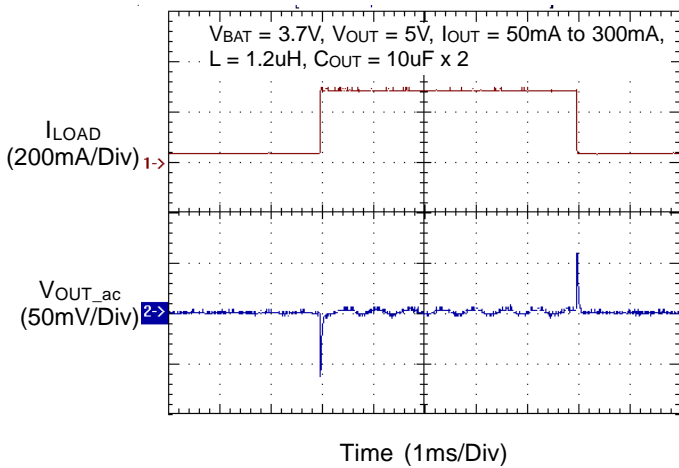

CH3 Load Transient Response

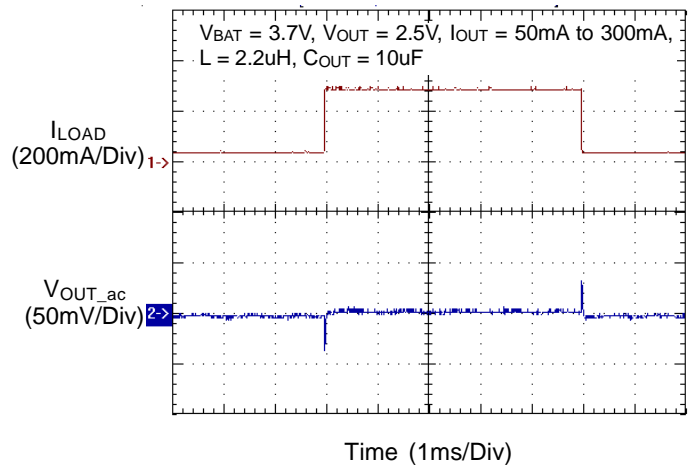

CH5 Load Transient Response

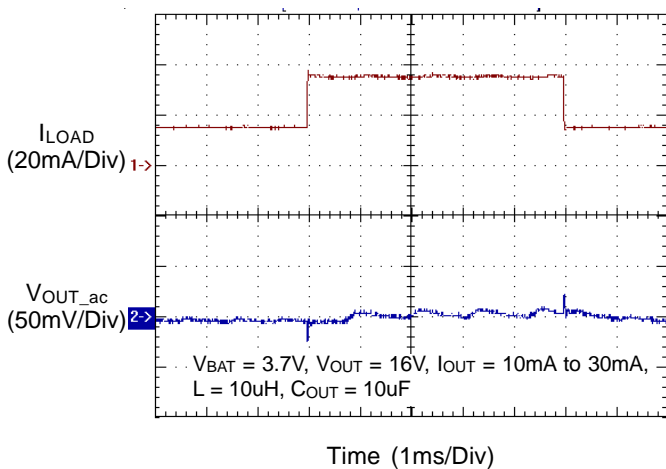

CH6 Load Transient Response

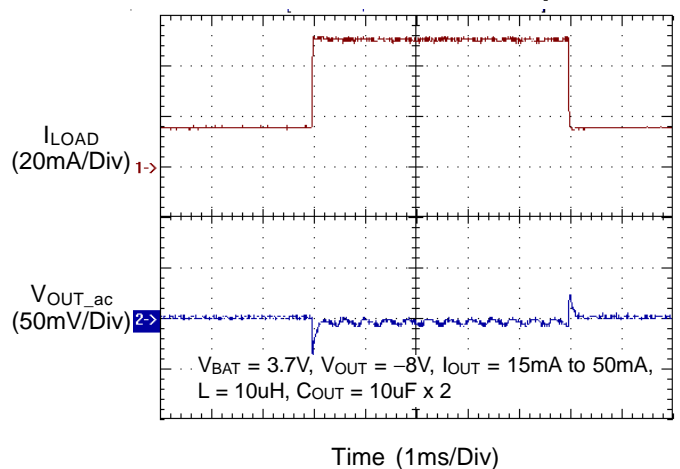

Application information

The RT9919 includes the following seven DC/DC converter channels to build a multiple-output power-supply system.

CH1 : Step-up synchronous current mode DC/DC converter with internal power MOSFETs. The output voltage could be load disconnected by a switch controller and an external P-MOSFET.

CH2 : Selectable step-up or step-down synchronous current mode DC/DC converter with internal power MOSFETs.

CH3 : Step-down synchronous current mode DC/DC converter with internal power MOSFETs and internal compensation network.

CH4 : Step-down synchronous current mode DC/DC converter with internal power MOSFETs and internal compensation network.

CH5 : Step-up asynchronous current mode DC/DC converter with internal power MOSFET and internal compensation network. The output voltage could be load disconnected by an internal P-MOSFET.

CH6 : Inverting current mode DC/DC converter with internal power MOSFET and internal compensation network.

CH7 : Current mode WLED driver with internal power MOSFET and internal compensation network. This channel also provides open LED protection.

SW1 : Load disconnect controller.

SW5 : Load disconnect switch for CH5

CH1 to CH4 operate in PWM mode with 2MHz and CH5 to CH7 operate in PWM mode with 1MHz constant frequency under moderate to heavy loading.

RTC_LDO : Low quiescent current, high output voltage accuracy LDO for Real Time Clock.

RTC_Reset : Accurate voltage detector for RTC LDO.

System_Reset : Accurate voltage detector for power sequence.

CH1 : Step-Up Converter

Step-up : The converter operates at fixed frequency PWM mode, continuous current mode (CCM), and discontinuous current mode (DCM) with internal MOSFET and synchronous rectifier for up to 95% efficiency.

CH2 : Selectable Step-Up or Step-Down Converter

Step-up : The converter operates at fixed frequency PWM mode, continuous current mode (CCM), and discontinuous current mode (DCM) with internal MOSFET and synchronous rectifier for up to 95% efficiency.

Step-down : The converter operates at fixed frequency PWM mode and continuous current mode (CCM) with internal MOSFET and synchronous rectifier for up to 95% efficiency.

While the input voltage is close to the output voltage, the converter enters low dropout mode. The duty could be as long as 100% to extend battery life.

CH3 : Step-Down DC/DC Converter

The converter operates at fixed frequency PWM mode, CCM and integrated internal compensation. While the input voltage is close to the output voltage, the converter could enter low dropout mode with low output ripple. The duty could be as long as 100% to extend battery life.

CH4 : Step-Down DC/DC Converter

The converter operates at fixed frequency PWM mode, CCM and integrated internal compensation. While the input voltage is close to the output voltage, the converter could enter low dropout mode with low output ripple. The duty could be as long as 100% to extend battery life.

CH5 : Step-Up DC/DC Converter

It integrates asynchronous boost with an internal MOSFET, internal compensation and an external schottky diode to provide CCD positive power supply. The converter is inactive until the SW5 soft start procedure is finished. This feature provides load disconnect function and effectively limits inrush current at start up.

CH6 : INV DC/DC Controller

This controller integrates an internal P-MOSFET and an external schottky diode to provide CCD negative power supply. The output voltage is set as

$$V_{OUT} = (R13/R14) \times (-V_{REF})$$

where R13 and R14 are the feedback resistors connected to FB6, V_{REF} equals to 1.25V in typical.

CH7 : WLED Driver

It is an asynchronous DC/DC converter with an internal MOSFET, internal compensation and an external schottky diode to drive up to 3 WLED. This channel also features PWM dimming control from EN7 pin and open diode protection. The current through WLED is set as

$$I \text{ (mA)} = [250\text{mV}/R(\Omega)] \times \text{Duty (\%)}$$

R : Current sense resistor from CFB7 to GND.

Duty: PWM dimming by EN7 pin. Dimming frequency range is from 30kHz to 100kHz.

Hold EN7 low for more than 64us will turn off CH7.

SW1

SW1 is an open drain controller to drive an external P-MOSFET and then functions as a load disconnect switch for CH1. This switch features soft start, Power On/Off Sequence and under voltage protection functions. OK is an open drain control pin. Once CH1, CH3, CH4 and CH2's soft start finish, SW1 is on. The OK pin is slowly pulled low and controlled with soft start to suppress the inrush current. VOUT1 is used for SW1 soft start and under voltage protection.

SW5

SW5 is an internal switch enabled by EN5 and functions as a load disconnection for CH5. This switch features soft start, Power On Sequence, over voltage (for SW5I) and under voltage (for SW5O) protection functions.

Charge Pumps

The charge pump function is enabled while the PVDD6 voltage is lower than 3.6V. This channel provides pump voltage to enhance MOSFET gate driving capability. This function is not necessary while battery is Li-ion type.

Reference Voltage

The RT9919 provides a precise 1.25V reference voltage with sourcing capability of 100uA. Connect a 0.1uF ceramic capacitor from VREF pin to GND. Reference voltage is enabled by connecting EN6 to logic high. Furthermore, this reference voltage is internally pulled to GND at shutdown.

RTC LDO

The RT9919 provides a LDO for real time clock. LDO function has features of low quiescent current (5uA) and high output voltage accuracy since this LDO is running all the time, even when the system is shutdown. In addition, LDO share "OK" and "VOUT1" pin with SW1 and function is decided by "CN" pin. Following table is used to select LDO or SW1.

Table1. RTC LDO Setting

CN	Function
High	RTC LDO
Low	SW1

RTC Reset

The RT9919 provides an accurate voltage detector for RTC LDO voltage detection. It is used to detect whether RTC LDO output voltage is ready or not. Its power pin is RTC_PWR and output pin is RTC_R. The output pin is an open drain N-MOSFET and the sink capability is above 4mA. Once the RTC_PWR pin reach 1.6V, it will count about 55ms, then the RTC_R go high.

System Reset

The RT9919 provides an accurate voltage detector. It is enabled by EN1234 and used to detect whether VOUT1 (SW1)/VOUT2 and VOUT3 output voltage are ready or not. Its output pin (SYS_R) is an open drain N-MOSFET and the sink capability is above 4mA.

Once Vout1 (SW1) voltage reaches 3V and FB3 voltage reaches 0.72V (90% of 0.8V), it will count about 10ms, then SYS_R go high for alkaline battery application.

Once the FB2 and FB3 voltage reach 0.72V, it will count about 10ms, then the SYS_R go high for Li-Ion battery application.

Mode Setting

Please refer to "Electrical Characteristics" for level of logic high or low.

Table 3. Mode Setting

SEL	CH2
High	Boost
Low	Buck

Mode setting is decided by the "SEL" pin. The CH2 of RT9919 features flexible boost or buck topology setting for either 1 x Li-ion or 2 x AA application by one pin. Please note that the logic state can not be changed during operation.

Power on/off sequence

The Power On Sequence is :

While EN1234 goes high, CH1 will be turned on to wait for the completion of CH1's soft start. After that, CH3 will be turned on to wait for the completion of CH3's soft start. And then, CH4 will be turned on to wait for the completion of CH4's soft start. Then, SW1 and CH2 will be turned on at the same time. Finally, SW1's soft start will be completed.

The Power-Off Sequence is :

At first, while EN1234 goes low, SW1 and CH2 (note 1) will be shutdown. After that, CH4 will be turned off and internally pulled low to wait for the completion of CH4's shutdown. And then, CH3 will be turned off and internally pulled low to wait for CH3's shutdown completion. Then, CH1 will be turned off and internally pulled low (note 2) to wait for CH1's shutdown completion. Finally, the whole IC will be shutdown (if EN5, EN6 and EN7 already go low).

Note 1 : If CH2 is configured as a Boost, then the CH2 will not be internally pulled low and the completion of shutdown will not be checked.

Note 2 : CH1 is configured as a Boost, so the CH1 will not be internally pulled low and the completion of shutdown will not be checked.

Table 4. Power On/Off Sequence

Power Sequence	
On	CH1 → CH3 → CH4 → (SW1 and CH2)
Off	(SW1 and CH2) → CH4 → CH3 → CH1

Thermal Considerations

For continuous operation, do not exceed absolute maximum operation junction temperature. The maximum power dissipation depends on the thermal resistance of IC package, PCB layout, the rate of surroundings airflow and temperature difference between junction to ambient. The maximum power dissipation can be calculated by following formula :

$$P_{D(MAX)} = (T_{J(MAX)} - T_A) / \theta_{JA}$$

Where $T_{J(MAX)}$ is the maximum operation junction temperature, T_A is the ambient temperature and the θ_{JA} is the junction to ambient thermal resistance.

For recommended operating conditions specification of RT9919, The maximum junction temperature is 125°C. The junction to ambient thermal resistance θ_{JA} is layout dependent. For WQFN-40L 5x5 packages, the thermal resistance θ_{JA} is 36°C/W on the standard JEDEC 51-7 four layers thermal test board. The maximum power dissipation at $T_A = 25^\circ\text{C}$ can be calculated by following formula :

$$P_{D(MAX)} = (125^\circ\text{C} - 25^\circ\text{C}) / (36^\circ\text{C/W}) = 2.778\text{W for WQFN-40L 5x5 packages}$$

The maximum power dissipation depends on operating ambient temperature for fixed $T_{J(MAX)}$ and thermal resistance θ_{JA} . For RT9919 packages, the Figure 1 of derating curves allows the designer to see the effect of rising ambient temperature on the maximum power allowed.

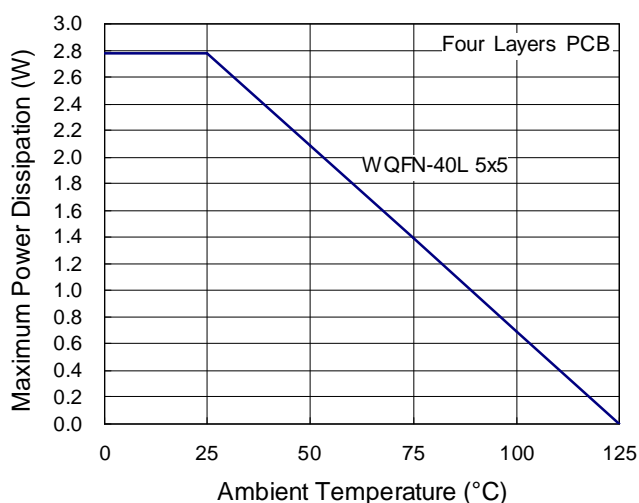

Figure 1. Derating Curves for RT9919 Packages

Layout Considerations

For the best performance of the RT9919, the following PCB layout guidelines must be strictly followed.

- } Place the input and output capacitors as close as possible to the input and output pins respectively for good filtering.
- } Keep the main power traces as wide and short as possible.
- } The switching node area connected to LX and inductor should be minimized for lower EMI.
- } Place the feedback components as close as possible to the FB pin and keep these components away from the noisy devices.
- } Place the compensative components as close as possible to the COMP pin and keep these components away from the noisy devices.
- } Connect the GND and Exposed Pad to a strong ground plane for maximum thermal dissipation and noise protection.

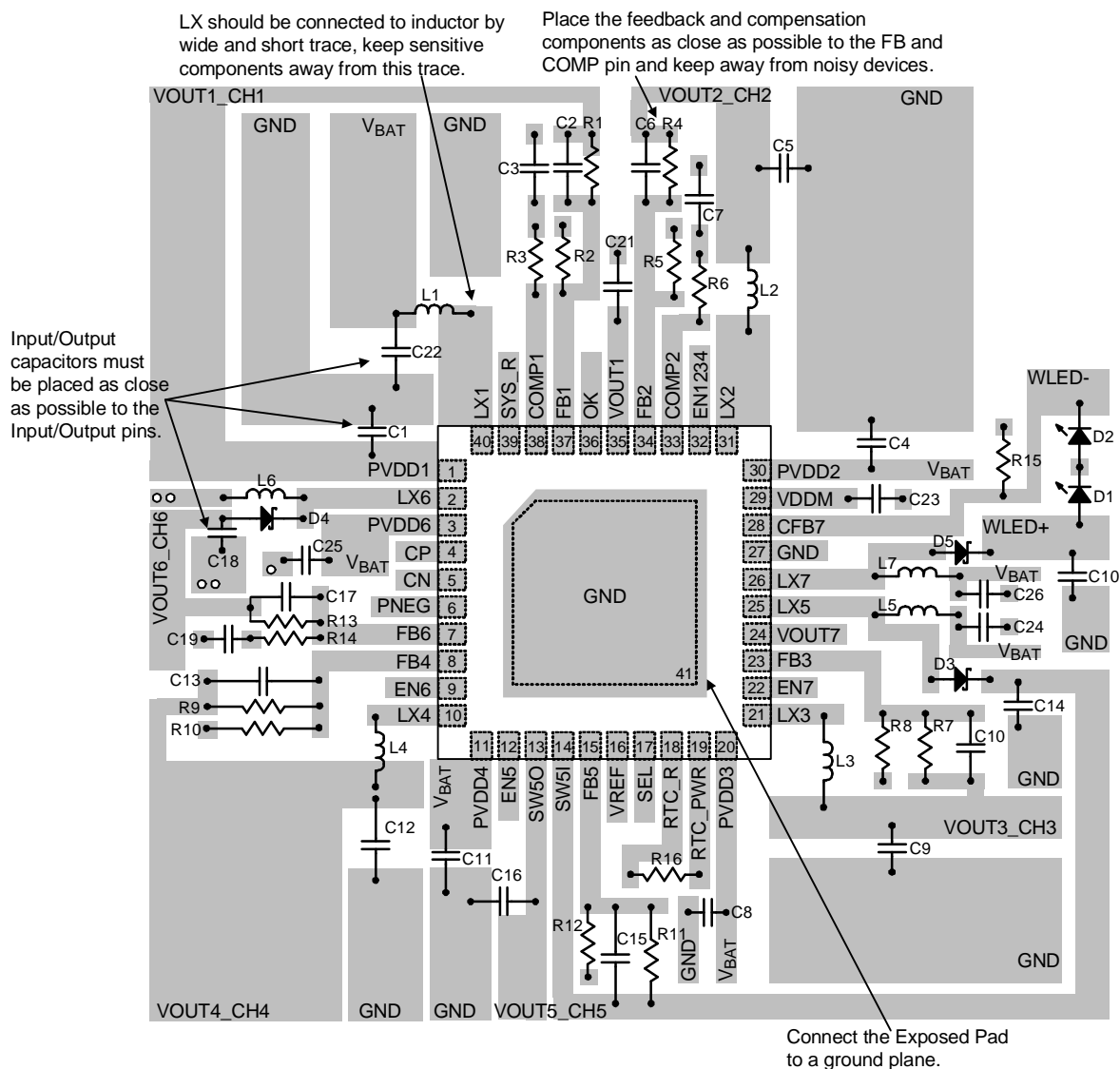
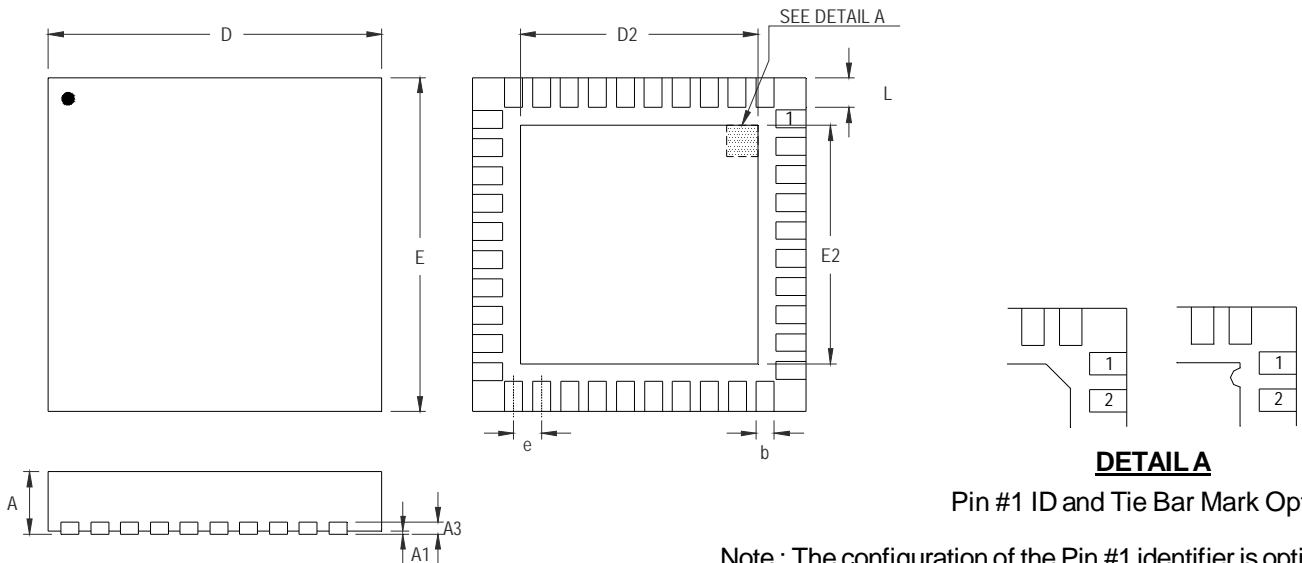

Figure 2. PCB Layout Guideline for Li-ion Application

Table 5. Protection Items

	Protection type	Threshold (typical) Refer to Electrical spec	Protection methods	IC Shutdown Delay time	Reset method
V _{DDM}	Over Voltage Protection	V _{DDM} > 6V	Automatic reset at V _{DDM} < 5.4V	100ms	V _{DDM} power reset
CH1 Boost	Current Limit	NMOS current > 3A	NMOS off, PMOS off, Automatic reset at next clock cycle	100ms	V _{DDM} power reset
	PVDD1 OVP	PVDD1 > 6V	NMOS off, PMOS off, Automatic reset at PVDD1 < 5.4V	100ms	V _{DDM} power reset
CH2 Boost	Current Limit	NMOS current > 3A	NMOS off, PMOS off, Automatic reset at next clock cycle	100ms	V _{DDM} power reset
	PVDD2 OVP	PVDD2 > 6V	NMOS off, PMOS off, Automatic reset at PVDD2 < 5.4V	100ms	V _{DDM} power reset
CH2 Buck	Current Limit	PMOS current > 1.5A	NMOS off, PMOS off, Automatic reset at next clock cycle	100ms	V _{DDM} power reset
CH3 Buck	Current Limit	PMOS current > 1.5A	NMOS off, PMOS off, Automatic reset at next clock cycle	100ms	V _{DDM} power reset
CH4 Buck	Current Limit	PMOS current > 1.5A	NMOS off, PMOS off, Automatic reset at next clock cycle	100ms	V _{DDM} power reset
CH5 Asyn Boost	Current Limit	NMOS current > 1.2A	NMOS off Automatic reset at next clock cycle	100ms	V _{DDM} power reset
CH6 Inverting	Current Limit	PMOS current > 1.5A	PMOS off Automatic reset at next clock cycle	100ms	V _{DDM} power reset
CH7 WLED	Current Limit	NMOS current > 0.8A	NMOS off Automatic reset at next clock cycle	Not Applicable	Automatic reset at next clock cycle
	OVP	VOUT7 > 14V	Shutdown CH7	Not Applicable	Reset by toggling EN7
SW1	UVP	VOUT1 < 1.75V after SW1 soft start end	Automatic reset at VOUT1 > 1.75V	100ms	V _{DDM} power reset
SW5	OVP	SW5I > 18V	NMOS off Automatic reset at SW5I < 18V	100ms	V _{DDM} power reset
	UVP	SW5O < 0.4V after SW5 soft start end	Automatic reset at SW5O > 0.4V	100ms	V _{DDM} power reset
Thermal	Thermal shutdown	Temperature > 160°C	All channels stop switching	No-delay	Temperature < 140°C
CH2 Buck	UVP	FB2 < 0.4V after CH2 soft start	NMOS off, PMOS off, Automatic reset at FB2 > 0.4V	100ms	V _{DDM} power reset
CH3 Buck	UVP	FB3 < 0.4V after CH3 soft start	NMOS off, PMOS off, Automatic reset at FB3 > 0.4V	100ms	V _{DDM} power reset
CH4 Buck	UVP	FB4 < 0.4V after CH4 soft start	NMOS off, PMOS off, Automatic reset at FB4 > 0.4V	100ms	V _{DDM} power reset

Outline Dimension



DETAILA
Pin #1 ID and Tie Bar Mark Options

Note : The configuration of the Pin #1 identifier is optional, but must be located within the zone indicated.

Symbol	Dimensions In Millimeters		Dimensions In Inches	
	Min	Max	Min	Max
A	0.700	0.800	0.028	0.031
A1	0.000	0.050	0.000	0.002
A3	0.175	0.250	0.007	0.010
b	0.150	0.250	0.006	0.010
D	4.950	5.050	0.195	0.199
D2	3.250	3.500	0.128	0.138
E	4.950	5.050	0.195	0.199
E2	3.250	3.500	0.128	0.138
e	0.400		0.016	
L	0.350	0.450	0.014	0.018

W-Type 40L QFN 5x5 Package

Richtek Technology Corporation

Headquarter
5F, No. 20, Taiyuen Street, Chupei City
Hsinchu, Taiwan, R.O.C.
Tel: (8863)5526789 Fax: (8863)5526611

Richtek Technology Corporation

Taipei Office (Marketing)
5F, No. 95, Minchiuan Road, Hsintien City
Taipei County, Taiwan, R.O.C.
Tel: (8862)86672399 Fax: (8862)86672377
Email: marketing@richtek.com

Information that is provided by Richtek Technology Corporation is believed to be accurate and reliable. Richtek reserves the right to make any change in circuit design, specification or other related things if necessary without notice at any time. No third party intellectual property infringement of the applications should be guaranteed by users when integrating Richtek products into any application. No legal responsibility for any said applications is assumed by Richtek.