

Product Features

- GaN on SiC Chip on Board
- Surface Mount Hybrid Type
- Asymmetric Doherty Amplifier
- High Efficiency
- No Matching circuit needed

Applications

- RF Sub-Systems
- Base Station
- RRH
- 4G/LTE system
- Small cell



Package Type : NP-8CL

Description

Accommodating the future of 4G/LTE small cells, RFHIC introduces RTH23007-10 amplifier fabricated using an advanced high power density Gallium Nitride (GaN) semiconductor process. This high performance amplifier achieves high efficiency of 45%, and powers 7W over the frequency range from 2300MHz to 2400MHz. Integrated with Asymmetrical Doherty configurations, RTH Series is packaged in a very small form-factor 28 x 19 x 4.8mm on AlN (aluminum nitride) board which provides excellent thermal dissipation.

Electrical Specifications @ $V_{ds} = 31V$, $T_a = 25^\circ C$

PARAMETER	UNIT	MIN	TYP	MAX	CONDITION
Frequency Range	MHz	2300	-	2400	ZS = ZL = 50 ohm
Power Gain	dB	12	14	-	Carrier Idq = 150mA Vgp = -4.8V
Gain Flatness		-3.0	-	3.0	
Input Return Loss		-	-9	-6	
Pout @ Average	dBm	-	38.5	-	Pulse Width=20us, Duty10%
Pout @ Psat	dBm	46	47	-	
ACLR @ BW 10MHz LTE (PAPR 7.5dB)	dBc	-	-27	-24	Non DPD
		-	-53	-	With DPD
Drain Efficiency	%	40	45	-	
Carrier Idq	mA	-	120	-	
Total Ids		-	500	-	
Supply Voltage	V	-	-3.5	-2.0	Vgc
		-	-5.0	-4.0	Vgp
		30.5	31	31.5	Vds

Caution

The drain voltage must be supplied to the device after the gate voltage is supplied
 Turn on : Turn on the Gate voltage supply and last turn on the Drain voltage supplies
 Turn off : Turn off the Drain voltage and last turn off the Gate voltage

Note

1. ACLR Measured Pout=38.5dBm @ $f_c \pm 10MHz / 9.015MHz$
 LTE 10MHz 1FA PAPR=7.5dB @ 0.01% probability on CCDF, (DPD Engine: Optichron OP6180)
2. RTH Series have internal DC blocking capacitors at the RF input and output ports

Mechanical Specifications

PARAMETER	UNIT	TYP	REMARK
Mass	g	5	-
Dimension	mm	28 x 19 x 4.8	-

Absolute Maximum Ratings

PARAMETER	UNIT	RATING	SYMBOL
Gate-Source Voltage	V	-10 ~ 0	Vgc Vgp
Drain-Source Voltage	V	50	Vds
Gate Current	mA	4.0	Igs
Operating Junction Temperature	°C	225	T _J
Operating Case Temperature	°C	-30 ~ 85	T _C
Storage Temperature	°C	-40 ~ 100	T _{STG}

Operating Voltage & Input Level

PARAMETER	UNIT	MIN	TYP	MAX	SYMBOL
Drain Voltage	V	30.5	31	31.5	Vds
Gate Voltage (on-stage)	V	-	Vgc @Carrier Idq	-2	Vgc
Gate Voltage (on-stage)	V	-	Vgp	-2	Vgp
Gate Voltage (off-stage)	V	-	-8	-	Vgc
Gate Voltage (off-stage)	V	-	-8	-	Vgp
RF Input Level	dB	-	-	35	Pin

*Vgp(Peaking gate voltage) set: Lower Vgp of Δ-1.9V at Peaking Idq 10mA

Block Diagram

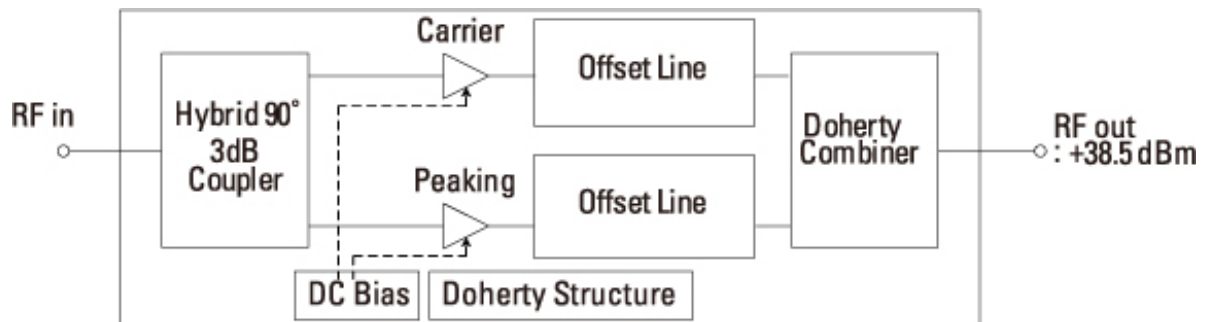

***Note**

Directional coupler, isolator and drive amplifier MUST be located CLOSE to the DUT(device under test) is needed for best performance.

Application Circuit

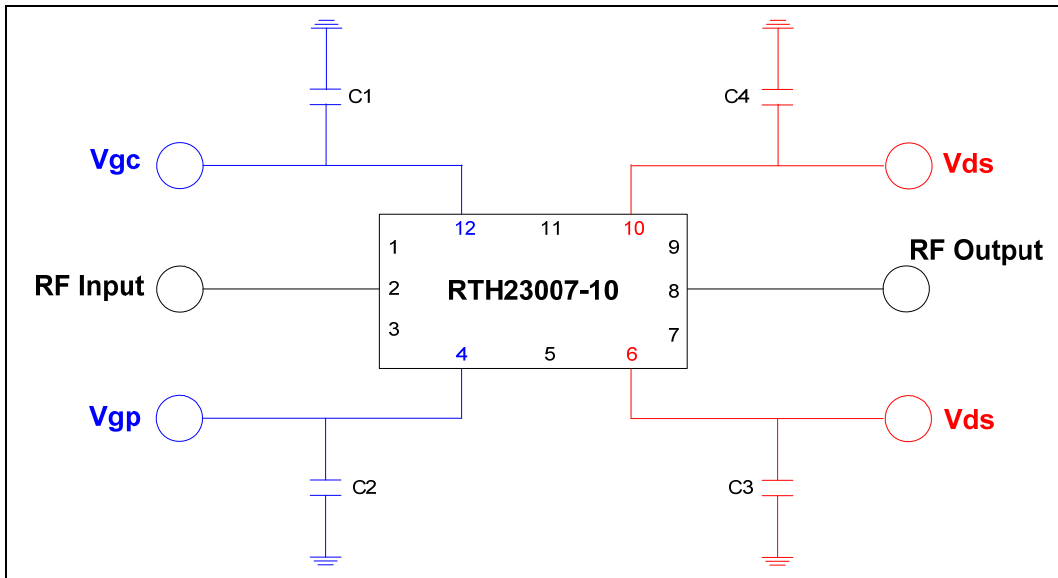

Part List

Location	Model No.	Spec.	Maker
C3, C4	1812C225K101CT	2.2uF / 100V	WALSIN
C1, C2	C3216X7R1C106K	10uF / 16V	TDK
Evaluation Board	RO4350B	2Layer, 30mil	ROGERS

Performance Charts

* Bias condition @ Carrier Idq= 150mA, Vgp= 4.8V, Ta=25 °C

Power Gain vs. Frequency

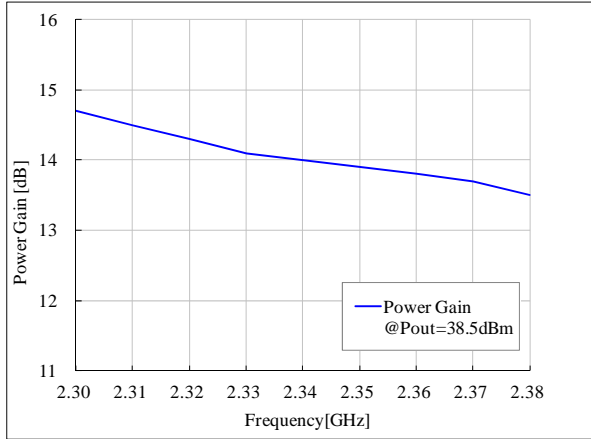

Psat vs. Frequency

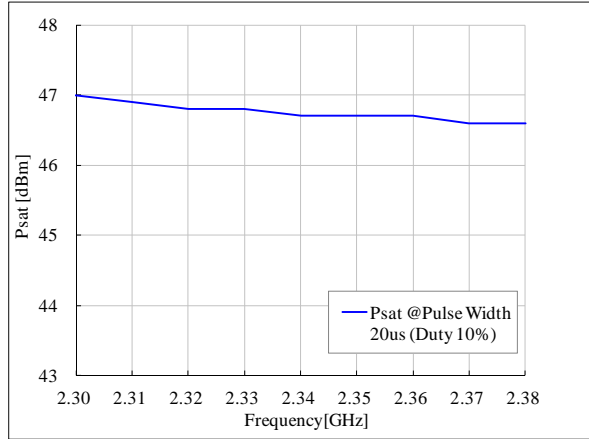

ACLR vs. Frequency

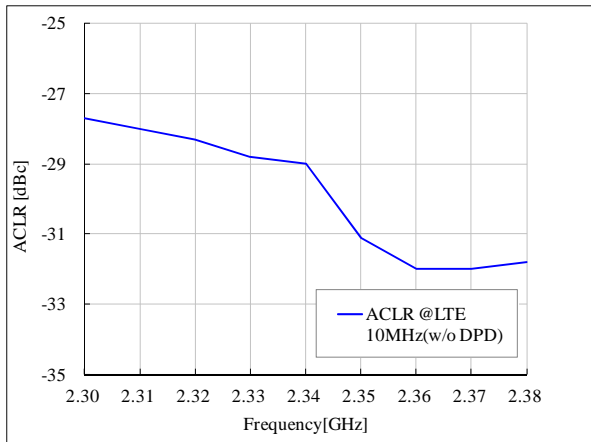

Drain Efficiency vs. Frequency

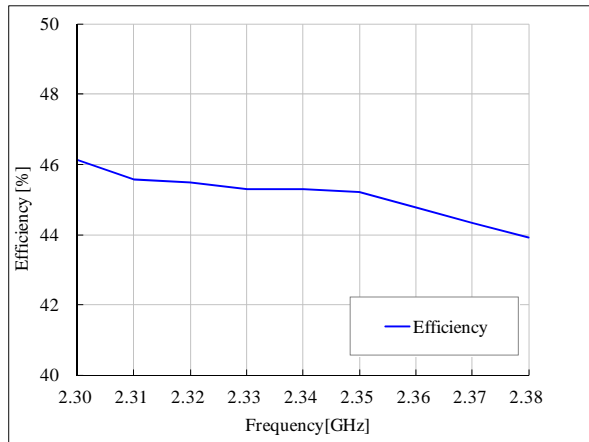

ACLR with Digital Predistortion

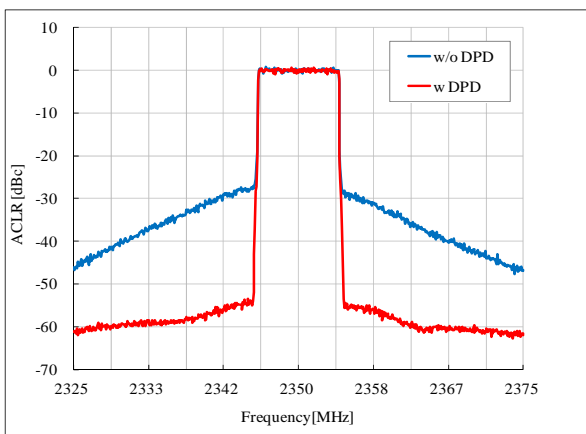

Ids vs. Frequency

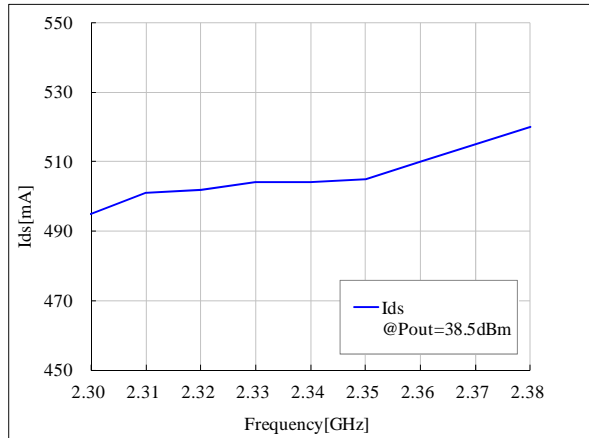

*DPD Engine: Optichron OP6180

Package Dimensions (Type: NP-8CL)

* Unit: mm[inch] | Tolerance: ±0.15[.008]

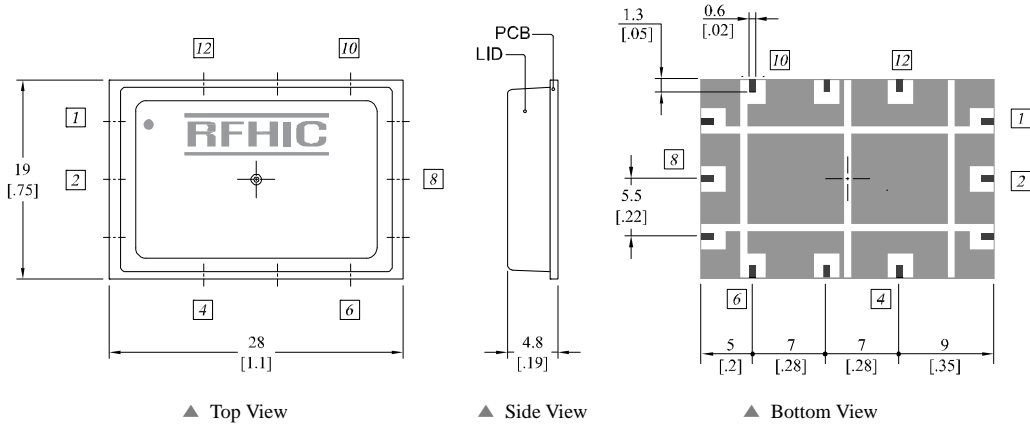

Pin Description							
Pin No	Function	Pin No	Function	Pin No	Function	Pin No	Function
1	GND	4	Vgp	7	GND	10	Vds
2	RF Input	5	GND	8	RF Output	11	GND
3	GND	6	Vds	9	GND	12	Vgc

Recommended Pattern

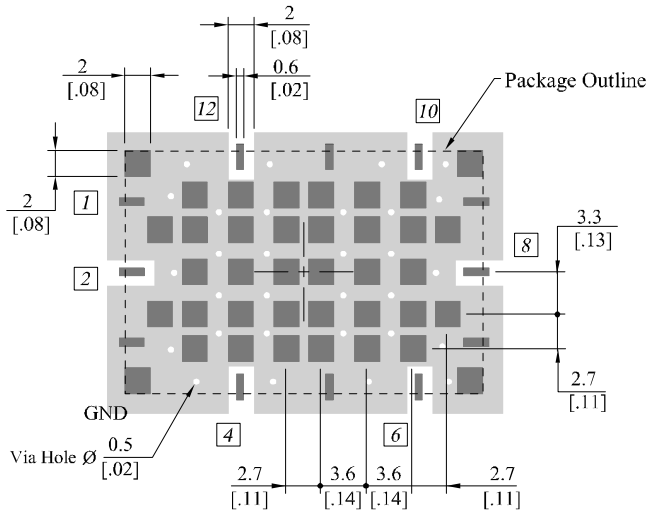

Recommended Mounting Configuration

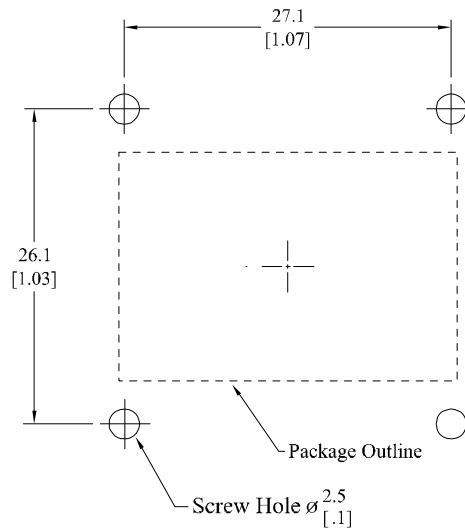

*** Mounting Configuration Notes**

1. For the proper performance of the device, Ground / Thermal via holes must be designed to remove heat.
2. To properly use heatsink, ensure the ground/thermal via hole region to contact the heatsink. We recommend the mounting screws be added near the heatsink to mount the board
3. In designing the necessary RF trace, width will depend upon the PCB material and construction.
4. Use 1 oz. Copper minimum thickness for the heatsink.
5. Do not put solder mask on the backside of the PCB in the region where the board contacts the heatsink
6. We recommend adding as much copper as possible to inner and outer layers near the part to ensure optimal thermal performance.

Precautions

This product is a Gallium Nitride Transistor.

The Gallium Nitride Transistor requires a Negative Voltage Bias which operates alongside a Positive Voltage Bias. These Biases are applied in accordance to the Sequence during Turn-On and Turn-Off.

The Pallet Amplifier does not have a built-in Bias Sequence Circuit. Therefore, users need to either apply positive voltages and negative voltages in the required sequence, or add an external Bias Circuit to this Amplifier.

The required sequence for power supply is as follows.

During Turn-On

1. Connect GND
2. Apply Gate Voltage (V_{gc} and V_{gp})
3. Apply Drain Voltage (V_{ds})
4. Apply the RF Power

During Turn-Off

1. Turn off RF power
2. Turn off Drain Voltage (V_{ds}), and then, turn off the Gate Voltage (V_{gc} and V_{gp})
3. Remove all connections

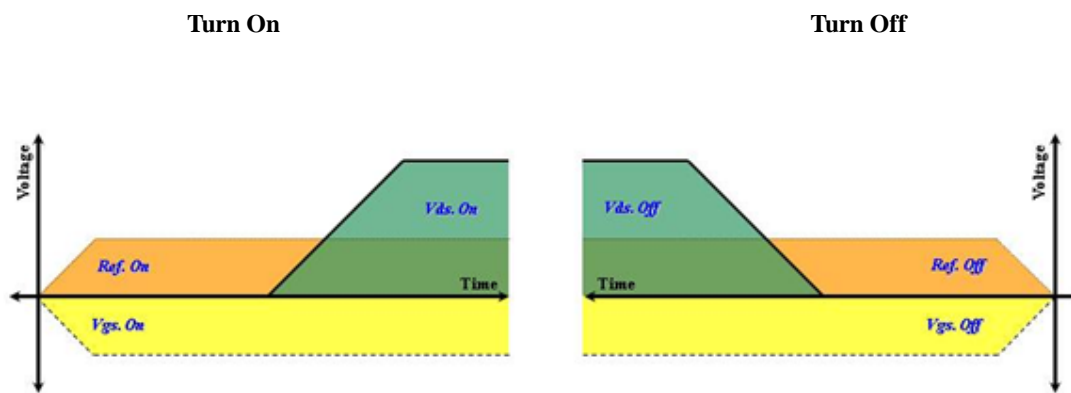

- Sequence Timing Diagram -

Reflow Profile

* Reflow oven settings

Zone	A	B	C	D	E	F
Temperature(°C)	30 ~ 150 °C	150 ~ 180 °C	180 ~ 220 °C	220 ~ 220 °C	235 ~ 240 °C	2 ~ 6 °C/ Sec Drop
Belt speed	55 ~ 115 sec	55 ~ 75 sec	30 ~ 50 sec	30 ~ 50 sec	5 ~ 10 sec	60 ~ 90 sec

Reflow Cycle Limit= 1time

* Measured reflow profile

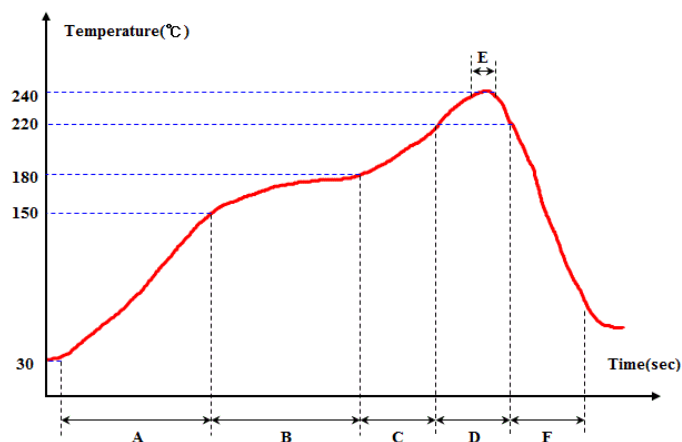

Ordering Information

Part Number	Package Design
RTH23007-10	-R (Reel)
	-B (Bulk)
	-EVB (Evaluation Board)

Revision History

Part Number	Release Date	Version	Modification	Data Sheet Status
RTH23007-10	2013.11.15	1.1	Electrical specification (1p)	-
RTH23007-10	2013.06.04	1.0	Electrical specification Operating Voltage & Input Level	-
RTH23007-10	2013.02.25	0.5	Frequency Range Package Dimension	Preliminary

RFHIC Corporation reserves the right to make changes to any products herein or to discontinue any product at any time without notice. While product specifications have been thoroughly examined for reliability, RFHIC Corporation strongly recommends buyers to verify that the information they are using is accurate before ordering. RFHIC Corporation does not assume any liability for the suitability of its products for any particular purpose, and disclaims any and all liability, including without limitation consequential or incidental damages. RFHIC products are not intended for use in life support equipment or application where malfunction of the product can be expected to result in personal injury or death. Buyer uses or sells such products for any such unintended or unauthorized application, buyer shall indemnify, protect and hold RFHIC Corporation and its directors, officers, stockholders, employees, representatives and distributors harmless against any and all claims arising out of such unauthorized use.

Sales, inquiries and support should be directed to the local authorized geographic distributor for RFHIC Corporation. For customers in the US, please contact the US Sales Team at 919-677-8780. For all other inquiries, please contact the International Sales Team at 82-31-250-5078.